

# EVM User's Guide: BQ25750

## BQ25750 Evaluation Module



### Description

The BQ25750EVM evaluation module (EVM) is a complete evaluation system for the BQ25750 IC, a buck-boost battery charge controller with direct power path control. The BQ25750 has a wide input range of 4.2V to 70V, a wide output voltage range of up to 70V, and bi-directional capabilities.

The BQ25750EVM has a max input of 55V, max output of 30V, and a max charge current of 10A.

### Get Started

1. Order the EVM on [ti.com](https://ti.com)
2. Order the [EV2400](#) or [USB2ANY](#) to communicate with the EVM
3. Download the BQ25750 BQZ file or use the [TI Charger GUI](#)
4. Download the BQ25750 EVM design files on [ti.com](https://ti.com)

### Features

- Wide input voltage operating range: 4.2V to 55V
- Wide output operating range: up to 30V with CC/CV support for:
  - 2- to 7-Cell Li-Ion
  - 2- to 8-Cell LiFePO4
  - Capacitor and Supercapacitor backup
- Synchronous buck-boost DC/DC charge controller with NFET drivers
  - Adjustable switching frequency from 200kHz to 600kHz
  - Optional synchronization to external clock
  - Optional gate driver supply input for optimized efficiency
- Resistor-programmable stand-alone with added I<sup>2</sup>C mode
- Built in MPPT to maximize power from solar panel arrays
- Power up from battery (reverse-mode) output 4V to 30V
- High safety integration
  - Adjustable input overvoltage and undervoltage protection
  - Output overvoltage and overcurrent protection

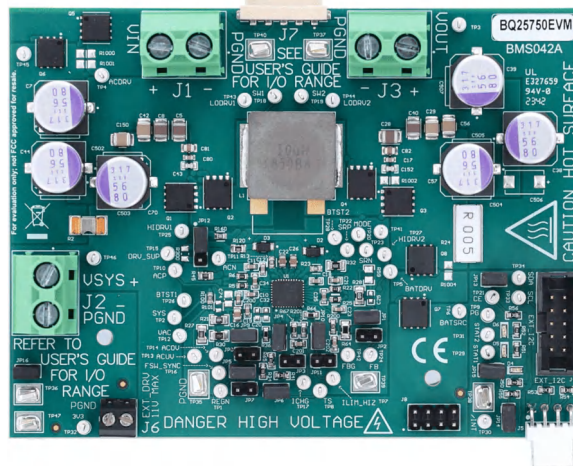

### CAUTION

The BQ25750 EVM can only support up to 30V battery hot plug. To use a battery above 30V it is recommended to install 10nF on C36, 10Ω on R9, and replace the EVM's BATFETS/ACFETS with a FET with a higher V<sub>TH</sub>. The NTMFSC4D2N10MC is recommended for the BATFETS.

# 1 Evaluation Module Overview

## 1.1 Introduction

The BQ25750 IC works for applications with up to 70V input and output. The BQ25750 IC implements a Li-Ion/LiFePO<sub>4</sub> batteries CC/CV profile. The BQ25750EVM also works with the full 240W range of the new USB-C Power Delivery (PD) Extended Power Range (EPR) specification. Typical applications include medical equipment, solar backup chargers, energy storage systems, drones, cordless power and garden tools.

This EVM does not include the EV2400 or USB2ANY interface device and does not provide any electrical isolation for the digital interfaces. [EV2400](#) or [USB2ANY](#) can be ordered separately to evaluate the BQ25750EVM and considering electrical safety is important when interfacing between the PC and EVM board. When interfacing the EVM to the PC through the digital interfaces, digital isolators with isolation boundary is recommended.

The BQ25750EVM does not have an isolation boundary and has smaller clearance and creep than normally used on high-voltage boards. If the user applies high voltage to this board, all terminals are considered high voltage and hazardous when live. Electric shock is possible when connecting the board to live wire. The board must be handled by a professional with care. TI recommends the use of isolated test equipment with safety protection features (such as overvoltage and overcurrent).

## 1.2 Kit Contents

This EVM kit includes:

- 1 BQ25750 EVM

## 1.3 Device Information

The BQ25750EVM evaluation module (EVM) is an evaluation system for the BQ25750 IC. The BQ25750 IC is a buck-boost battery charge controller with direct power path control. The BQ25750 has a wide input range of 4.2V to 70V, a wide output voltage range of up to 70V, bi-directional capabilities, and a charge current of up to 20A.

The device offers high-efficiency battery charging with accurate charge current and charge voltage regulation over a wide voltage range. The design also includes automatic charge preconditioning, termination, and charge status indication. The device integrates loop compensation for the buck-boost converter, which provides a high-density design with ease of use. In reverse mode, the device draws power from the battery and regulates the SYS terminal voltage.

The device supports stand-alone charging mode through resistor programmable limits in addition to the I<sup>2</sup>C host-controlled charging mode. Input current, charge current, and charge voltage regulation targets are set through the ILIM\_HIZ, ICHG and FB pins, respectively.

## 1.4 Texas Instruments High Voltage Evaluation User Safety Guidelines



Always follow TI's set-up and application instructions, including use of all interface components within their recommended electrical rated voltage and power limits. Always use electrical safety precautions to help verify your personal safety and those working around you. Contact TI's Product Information Center <http://ti.com/customer-support> for further information.

**Save all warnings and instructions for future reference.**

**WARNING**  
Failure to follow warnings and instructions can result in personal injury, property damage or death due to electrical shock and burn hazards.

The term TI HV EVM refers to an electronic device typically provided as an open framed, unenclosed printed circuit board assembly. It is *intended strictly for use in development laboratory environments, solely for qualified professional users having training, expertise and knowledge of electrical safety risks in development and application of high voltage electrical circuits. Any other use and/or application are strictly prohibited by Texas Instruments.* If you are not suitably qualified, then you need to immediately stop from further use of the HV EVM.

### 1. Work Area Safety:

- a. Keep work area clean and orderly.
- b. Qualified observers must be present anytime circuits are energized.
- c. Effective barriers and signage must be present in the area where the TI HV EVM and the interface electronics are energized, indicating operation of accessible high voltages can be present, for the purpose of protecting inadvertent access.
- d. All interface circuits, power supplies, evaluation modules, instruments, meters, scopes, and other related apparatus used in a development environment exceeding 50Vrms/75VDC must be electrically located within a protected Emergency Power Off EPO protected power strip.
- e. Use stable and non-conductive work surface.
- f. Use adequately insulated clamps and wires to attach measurement probes and instruments. No freehand testing whenever possible.

### 2. Electrical Safety:

- a. As a precautionary measure, a good engineering practice to assume is that the entire EVM can have fully accessible and active high voltages.
- b. De-energize the TI HV EVM and all the inputs, outputs and electrical loads before performing any electrical or other diagnostic measurements. Re-validate that TI HV EVM power has been safely de-energized.
- c. With the EVM confirmed de-energized, proceed with required electrical circuit configurations, wiring, measurement equipment hook-ups and other application needs, while still assuming the EVM circuit and measuring instruments are electrically live.
- d. Once EVM readiness is complete, energize the EVM as intended.

**WARNING**  
While the EVM is energized, never touch the EVM or the electrical circuits, as the electrical circuits and EVM can be at high voltages capable of causing electrical shock hazard.

### 3. Personal Safety

- a. Wear personal protective equipment e.g. latex gloves or safety glasses with side shields or protect EVM in an adequate lucent plastic box with interlocks from accidental touch.

**Limitation for safe use:**

EVMs are not to be used as all or part of a production unit.

### 1.4.1 General Safety Information

The following warnings and cautions are noted for the safety of anyone using or working close to the BQ25750 EVM. Observe all safety precautions.



**Warning Caution**

The BQ25750EVM circuit module can become hot during operation due to the dissipation of heat. Avoid contact with the board. Follow all safety procedures applicable to your laboratory.

**CAUTION**

Hot surface. Contact can cause burns. Do not touch!



**Warning**

The BQ25750EVM does not have an isolation boundary and has smaller clearance and creep than normally used on high-voltage boards. If the user applies high voltage to this board, all terminals are considered high voltage and hazardous when live. Electric shock is possible when connecting the board to live wire. The board must be handled by a professional with care. TI recommends the use of isolated test equipment with safety protection features (such as overvoltage and overcurrent).



**Warning**

High voltages that can cause injury exist on this evaluation module (EVM). Please follow all safety procedures when working on this EVM. Never leave a powered EVM unattended.



**Warning**

High voltage can be present on board capacitors after power down. Check and discharge all on-board energy reservoirs properly after EVM power down.



**Caution**

Do not leave the EVM powered when unattended.

**CAUTION**

The communication interfaces are not isolated on the EVM. TI recommends the use of digital isolators. Observe all high voltage safety precautions during testing.

**CAUTION**

Connections for a rated current must be made at the terminal block. Test points are not rated for the board current.

**CAUTION**

The circuit module can be damaged by overtemperature. To avoid damage, monitor the temperature during evaluation and provide cooling, as needed, for your system environment. Do not operate beyond the current and voltage limits in [Section 2.3](#).

**CAUTION**

Test equipment can be damaged by the application of external voltages. Check your equipment requirements and use blocking diodes or other isolation techniques, as needed, to prevent damage to your equipment.

**CAUTION**

The circuit module has signal traces, components, and component leads on the bottom of the board. Exposed voltages, hot surfaces, or sharp edges can result in these areas. Do not reach under the board during operation.

**CAUTION**

The default settings of the BQ25750 are not designed for all applications. Set the EVM settings appropriately for test setup before device power up. Set all protections appropriately and limit current for safe operations.

**CAUTION**

The board has no fuse installed and relies on the external voltage source current limit for circuit protection.

## 2 Hardware

### 2.1 Board Parameters

**Table 2-1. Default Board Setup for BQ25750EVM**

	Description	Value	Unit
ACUV	Input undervoltage	4.2	V
ACOV	Input overvoltage	55	V
IIN	Input current of the EVM	8	A
IOUT	Output current of the EVM	10	A
FSW_SYNC	Switching frequency of the power stage	250	kHz

**Table 2-2. PCB and Mechanical Parameters**

	Value	Unit
Board size (X dimension, or length)	112	mm
Board size (Y dimension, or width)	84	mm
IC + power stage max height	5	mm
Total copper layers	6	layer
Copper weight per layer	2	oz
Total board thickness	62	mil

### 2.2 IO and Jumper Descriptions

**Table 2-3. Connector and Port Description**

Jack	Description
J1-VIN	Input: positive terminal
J1-PGND	Input: negative terminal (ground terminal)
J2-VSYS	Charger system output voltage, typically connected to the system load
J2-PGND	Ground
J3-VOUT	Connected to battery pack output
J3-PGND	Ground
J4-EXT_I2C	Communication port for the USB2ANY
J5-I2C	Communication port for the EV2400
J6-EXT_DRV	Connection for external gate drive
J7-Power Connector	Connection for VAC and BAT
J8-Communication Port	Connection for EXT_DRV, /INT, I <sup>2</sup> C, /PG, and 3.3 V

**Table 2-4. Jumper Description**

Jumper	Description	Factory Default
JP1	Use JP1 to connect the default feedback resistor and set the charger to the default 7-cell battery.	Installed
JP2	Use JP2 to connect a new feedback resistor to program a different cell count.	Not installed
JP3	Use JP3 to connect external IOUT resistor. JP3 can be shorted to PGND to turn off hardware output current limiting.	Not installed
JP4	Shunt JP4 to use default IOUT resistor. By closing JP4, the default IOUT current is set to 10A.	Installed
JP5	Shunt JP5 to bias TS.	Installed
JP6	With JP5 shunted (REGN connected for voltage divider). Shunt JP6 to set TS status to normal.	Installed
JP7	With JP5 shunted (REGN connected for voltage divider). Use JP7 to connect external resistor to change TS status.	Not installed
JP8	Use JP8 to connect external FSW_SYNC resistor.	Not installed
JP9	Shunt JP9 to use default FSW_SYNC resistor. By closing JP9, the default switching frequency is set to 250kHz.	Installed
JP10	Shunt JP10 to use default IIN resistor. By closing JP10, the maximum input current is set to 8A.	Installed
JP11	Use JP11 to connect external IIN resistor. JP11 can be shorted to PGND to turn off hardware input current limiting.	Not installed
JP12	Use JP12 to select the gate driver source. Shunt pin1 to pin2 to use IC internal LDO REGN output. Shunt pin2 to pin3 to use external gate drive supply. Maximum external gate drive supply can be up to 11V.	Pin1 and pin2 shunted
JP13	Shunt JP13 to enable controller in forward mode. Open JP13 to disable controller. The /CE pin can also be used as a general purpose indicator.	Installed
JP14	Shunt JP14 to connect /INT to a pullup rail.	Installed
JP15	Shunt JP15 to connect STAT1 to a pullup rail. The STAT1 pin can also be used as a general purpose indicator.	Installed
JP16	Shunt JP16 to generate on board 3.3V pullup rail.	Installed

## 2.3 Recommended Operating Conditions

**Table 2-5. Recommended Operating Conditions for BQ25750EVM**

	Description	Min	Typ	Max	Unit
VIN (J1)	Input voltage to the EVM	4.2		55 <sup>(1)</sup>	V
VOOUT (J3)	Output voltage of the EVM	3.3		30 <sup>(1)</sup>	V
IIN (J1)	Input current of the EVM			10 <sup>(3)</sup> (4)	A
IOUT (J3)	Output current of the EVM			10 <sup>(3)</sup>	A
Power path switchover current limit	Max current that can flow through the BATFETs while the BATFETs are turning ON			8	A
Regulator output power	Output power of the EVM			400 <sup>(3)</sup>	W
EXT_DRV (J6)	Voltage applied to DRV_SUP pin of the regulator	4		11	V
EVM Operating ambient temperature (T <sub>A</sub> )			25 <sup>(2)</sup>		°C

- (1) Nodes on the EVM can have high spikes above the input voltage (in buck mode) or output voltage (in boost mode) level due to the high di/dt and dv/dt electrical flow associated with switch-mode power supplies. Switch node voltage can swing up to *input or output + inductive spike* level. High-side gate drives can swing up to *switch node voltage + 11 V (DRV\_SUP supply voltage dependent) + gate drive inductive spike* level. Observe safety precautions at all times.
- (2) Connectors, bump-ons, and jumpers on the EVM are not good choices for evaluation under temperatures that greatly deviate from a room temperature of 25°C. Refer to the Bill of Materials (BOM) for temperature ratings of board components.
- (3) TI recommends thermal monitoring (for example, using a thermal camera) if the power-stage output current > 5A or total output power > 100W.
- (4) The default EVM input current limit is set to 20A through the IIN pin. The current-limiting feature can be adjusted by setting the EN\_IIN\_PIN bit to '0', changing the IIN pin resistor, or shorting the IIN pin to PGND through JP11.



## 2.4 Communication Interface Setup

The charger is controlled by a state machine that uses I<sup>2</sup>C registers and the state machine makes decisions based off of the I<sup>2</sup>C registers. Software only helps with reading and writing to those registers.

### 2.4.1 BQSTUDIO using EV2400

Download the latest version of [BQSTUDIOTEST](#). Double click the *Battery Management Studio* installation file and follow the installation steps. The software supports Microsoft® Windows® XP, 7, and 10 operating systems. Launch BQSTUDIO and select *Charger*. If the EVM configuration file for BQSTUDIO does not appear in the Charger, close BQSTUDIO and either download the .BQZ file from the EVM product folder at [www.ti.com](http://www.ti.com) or download the file via [BQ25750.bqz file](#). The file must be saved into C:\XXX\BatteryManagementStudio\config, where XXX is the directory you selected to install BQSTUDIO.

### 2.4.2 TI Charger GUI for USB2ANY

Navigate to the [TI-CHARGER-GUI](#) tool folder. Once at the tool page, click on the *Evaluate in the cloud* button. The browser automatically redirects to the TI Charger GUI landing page. From the landing page, locate the device desired for evaluation and click *Select Device*. Note that the EVM must be powered and the USB2ANY must be connected to both the EVM and the PC for a connection to be established. Also, update the USB2ANY to the latest version with the [USB2ANY Explorer Software](#).

## 2.5 Equipment

TI recommends two ways to test the EVM. The first and preferred way to test the EVM is to use a four-quadrant power supply. The second is to use a electronic load in constant voltage mode. Testing with a constant voltage load is covered in [Section 2.5.3](#). TI recommends the following list of equipment when testing with a four-quadrant power supply.

1. **Power Supplies:**

A power supply capable of supplying 40V at 8A is required. This part can handle larger voltage and current, however, larger power levels are not necessary for this procedure.

2. **Load 1:**

A Kepco load: BOP36-6M, DC 0 to  $\pm 30V$ , 0 to  $\pm 6A$  (or higher), or equivalent. When testing without a real battery, connect 2000 $\mu F$  of capacitance across the input.

3. **Meters:**

Six Fluke 75 multimeters, (equivalent or better) or: Three equivalent voltage meters and three equivalent current meters.

4. **Computer:**

A computer with at least one USB port and a USB cable.

5. **EV2400 Communication Kit or USB2ANY Communication Kit**

6. **Software:**

For software setup, refer to [Section 2.4](#).

### 2.5.1 Equipment Set Up

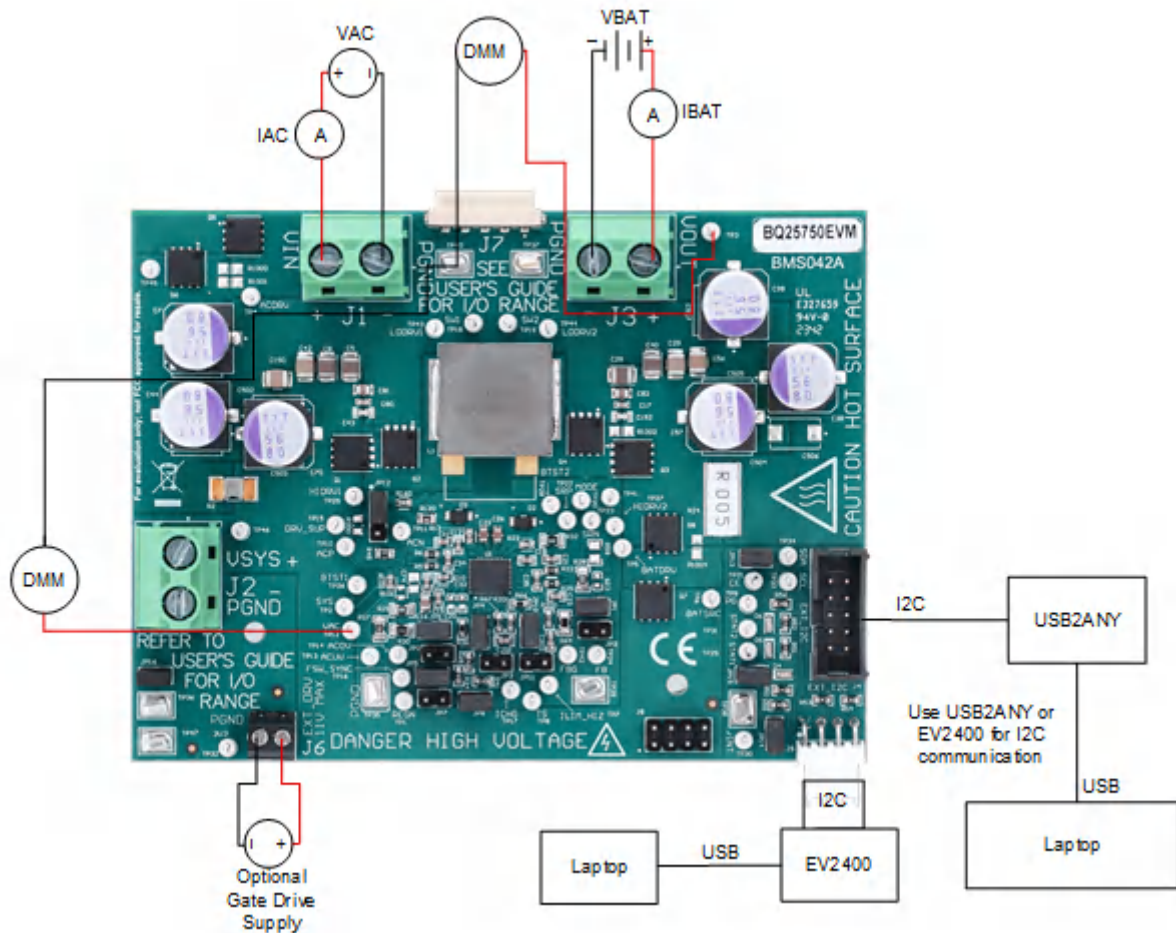

Use the following guidelines to set up the equipment:

1. Set power supply 1 for 23V DC, 8A current limit and then turn off the supply.
2. Connect the output of power supply 1 in series with a current meter to J1 (VIN and PGND).

3. Connect a voltage meter across J1 (VIN) and J1 (PGND).
4. Connect load 1 in series with a current meter to J3 (VBAT and PGND).
5. Connect a voltage meter across J5 (VBAT and PGND).
6. Set 23V at KEPCO load output. Limit KEPCO to 6A. Use load 2 to power EVM from the VOUT output.
7. Install the jumpers as indicated in IO and Jumper Descriptions.
8. If using Battery Management Studio, use the following steps:
  - a. Connect J5 to the EV2400. Connect J5 to the I<sup>2</sup>C PORT 2 on the EV2400
  - b. Turn on the computer and load 2. Open the bqStudio software.
  - c. Select *Charger* and click the *Next* button.

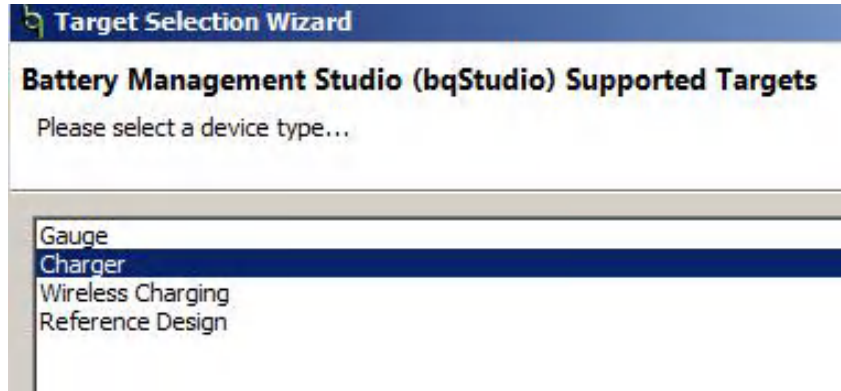

- d. Select *Charger\_1\_00\_BQ25750.bqz* on the *Select a Target Page*.
- e. Click *Field View* after selecting the target device and then click the *Read Register* button.

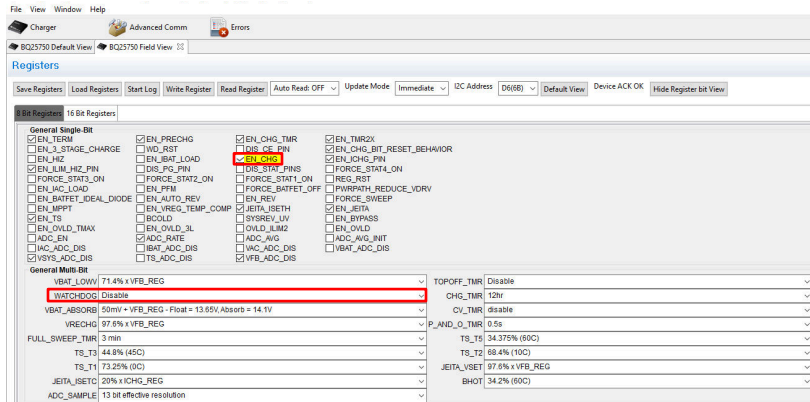

- f. Set WATCHDOG and EN\_CHG to disabled

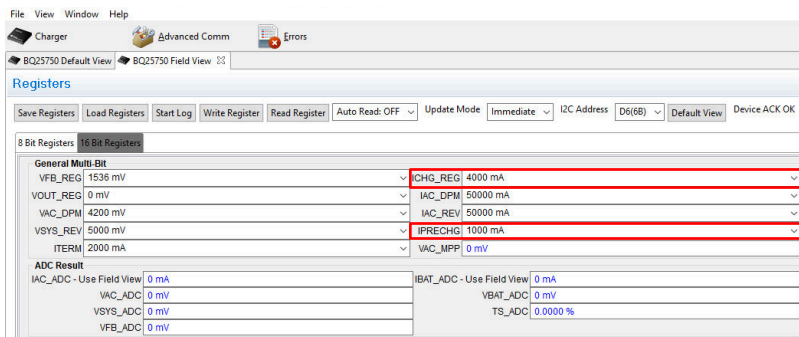

9. If using TI Charger GUI, use the following steps:
  - a. Connect J4 to the USB2ANY. Turn on the computer and load 2.
  - b. Navigate to the [TI Charger GUI website](#) and select the charger you are using:

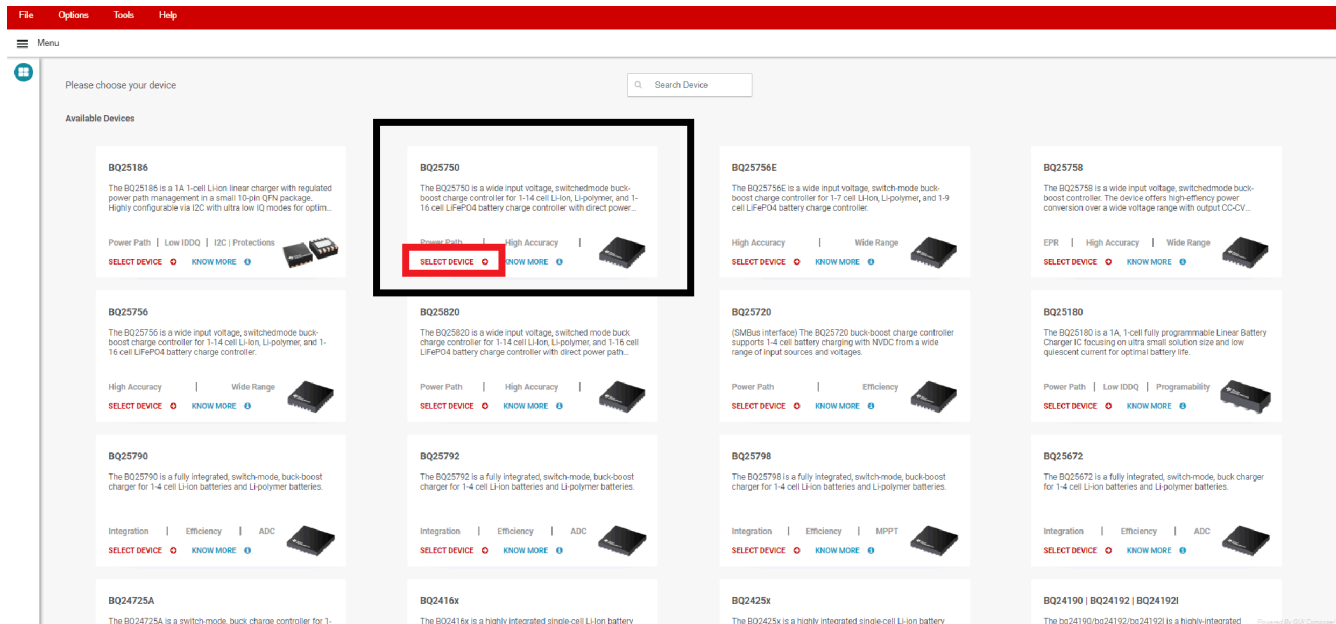

c. You should see at the top-left, Hardware Connected. After you see the hardware is connected, select the plug icon on the left panel.

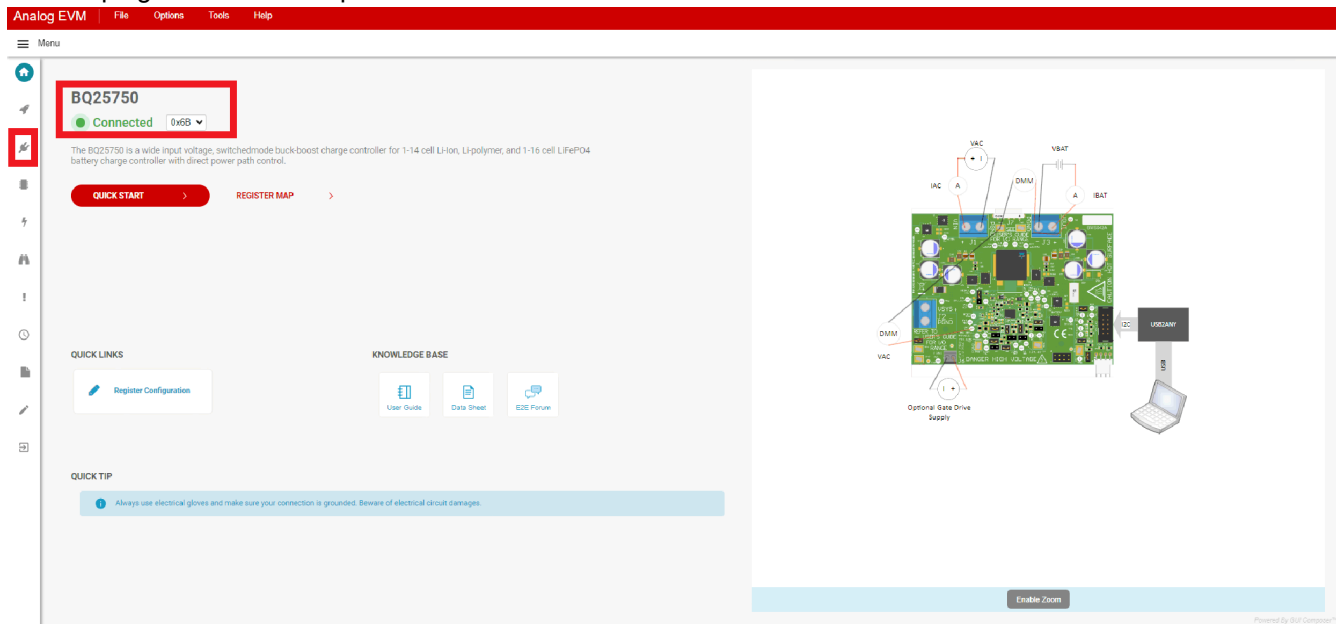

d. This is the Charger Configuration window. Click the Read All Register button at the top, then set WATCHDOG and EN\_CHG to disabled. Set ICHG\_REG to 4000mA and IPRECHG to 1000mA

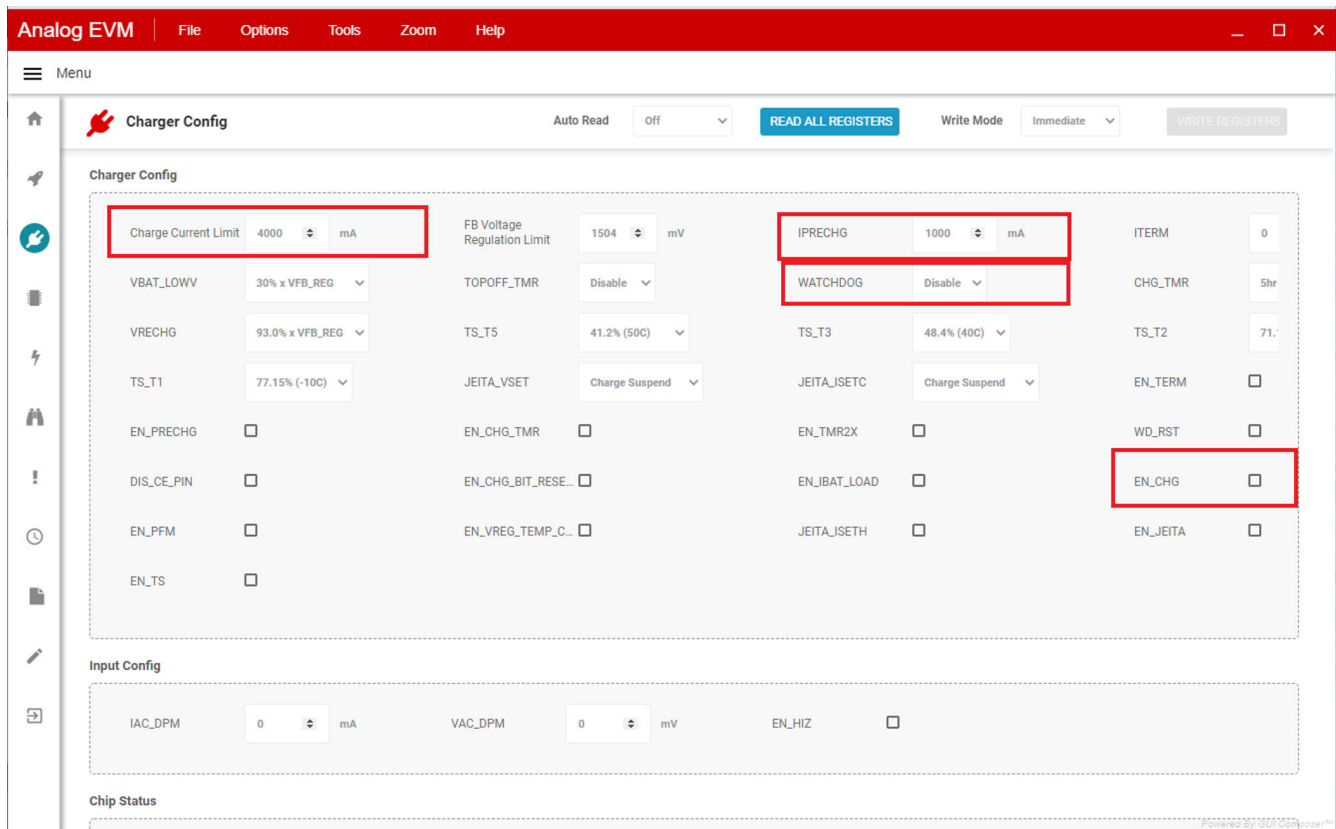

- e. Here is a brief description of what the other icons on the left side panel mean. Select through these icons to configure other operations of the battery charger.

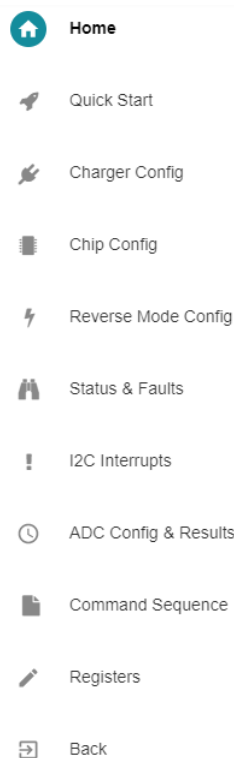

10. Turn on power supply 1, measure:

$$V(J1(VAC)) = 23V \pm 0.5V$$

$$I(J1(IAC)) = 4.1A \pm 0.5A$$

$$V(J3(VBAT)) = 23V \pm 0.5V$$

$$I(J3(IBAT)) = 3.9A \pm 0.5A$$

11. Set power supply 1 for 40V, measure:

$$V(J1(VAC)) = 40V \pm 0.5V$$

$$I(J1(IAC)) = 2.4A \pm 0.5A$$

$$V(J3(VBAT)) = 23V \pm 0.5V$$

$$I(J3(IBAT)) = 3.9A \pm 0.5A$$

12. Set power supply 1 for 19V, measure:

$$V(J1(VAC)) = 19V \pm 0.5V$$

$$I(J1(IAC)) = 5.0A \pm 0.5A$$

$$V(J3(VBAT)) = 23V \pm 0.5V$$

$$I(J3(IBAT)) = 3.9A \pm 0.5A$$

Use the following guidelines to test the BQ25750 EVM power path:

1. Disconnect the power supply from J1 (VIN and PGND) and disconnect Load 1 from J3 (VOUT and PGND).
2. Connect the output of power supply #1 to J3 (VOUT and PGND).
3. Set power supply 1 for 20V DC, 8A current limit and then turn off power supply.
4. Connect a voltage meter across J2 (VSY) and J2 (PGND).
5. Turn on power supply 1, measure  $V(J2(VSY)) = 20V \pm 0.5V$ .

### 2.5.2 Equipment - Using a CV Load

The following list of equipment is recommended when testing with a constant voltage electronic load.

1. **Power Supplies:**  
A power supply capable of supplying 40V at 8A is required. This part can handle larger voltage and current, however, larger power levels are not necessary for this procedure.
2. **Load 1:**  
Kikusui PLZ164WA 0 to 150V, 0 to 33A when testing without a real battery, connect 2000 $\mu$ F of capacitance across the input.
3. **Meters:**  
Six Fluke 75 multimeters (equivalent or better) or three equivalent voltage meters and three equivalent current meters.
4. **Computer:**  
A computer with at least one USB port and a USB cable.
5. **EV2400 Communication Kit or USB2ANY Communication Kit**
6. **Software:**  
For software setup, refer to [Section 2.4](#).

### 2.5.3 Equipment Setup - Using a CV Load

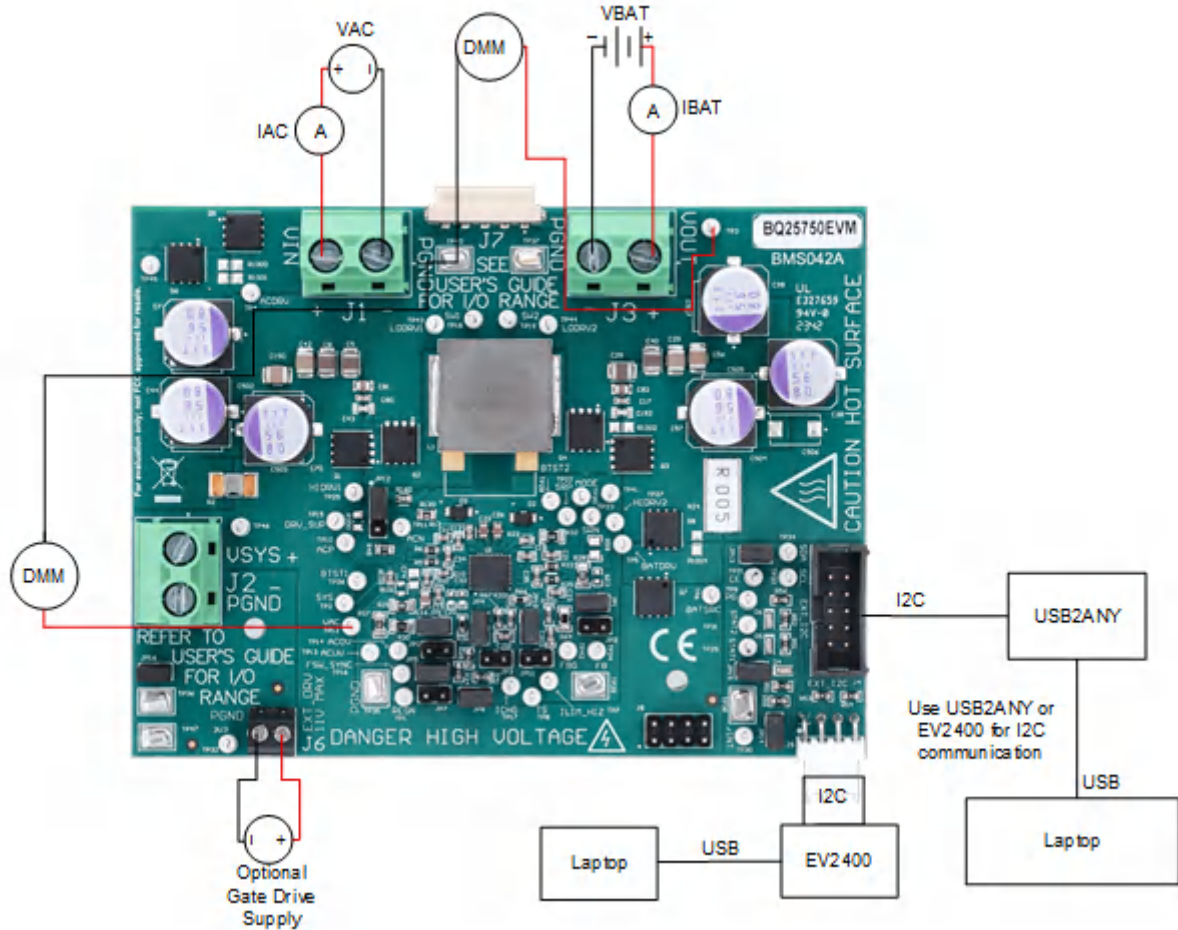

Use the following guidelines to set up the equipment:

1. Set power supply 1 for 40VDC, 6A current limit and then turn off the supply.
2. Connect the output of power supply 1 in series with a current meter to J1 (VIN and PGND).
3. Connect a voltage meter across J1 (VIN) and J1 (PGND).
4. Connect load 1 in series with a current meter to J3 (VBAT and PGND).
5. Connect a voltage meter across J5 (VBAT and PGND).
6. Set 23.5V at electronic load input.
7. Install the jumpers as indicated in [Section 2.2](#).
8. Unplug Jumper 13.
9. If using Battery Management Studio, use the following steps:
  - a. Connect J5 to the EV2400. Connect J5 to the I<sup>2</sup>C PORT 2 on the EV2400.
  - b. Turn on the computer and load 2. Open the bqStudio software.
  - c. Select *Charger* and click the *Next* button.

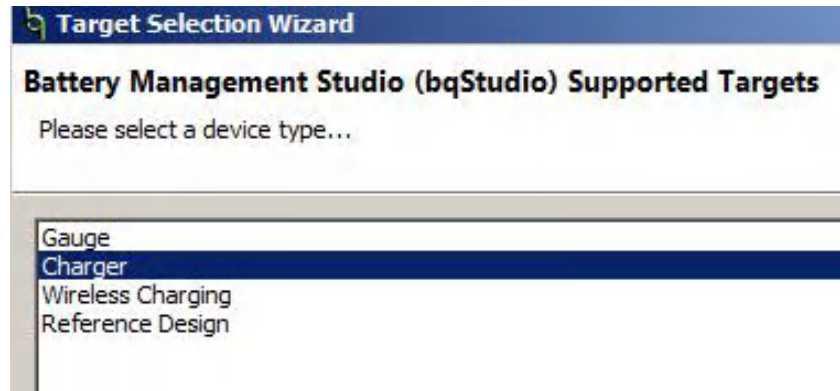

- d. Select *Charger\_1\_00\_BQ25750.bqz* on the *Select a Target Page*.
- e. Click *Field View* after selecting the target device and then click the *Read Register* button.

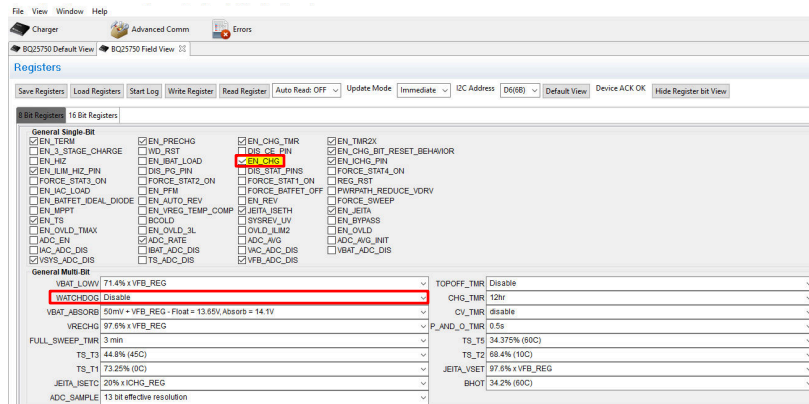

- f. Set WATCHDOG and EN\_CHG to disabled.

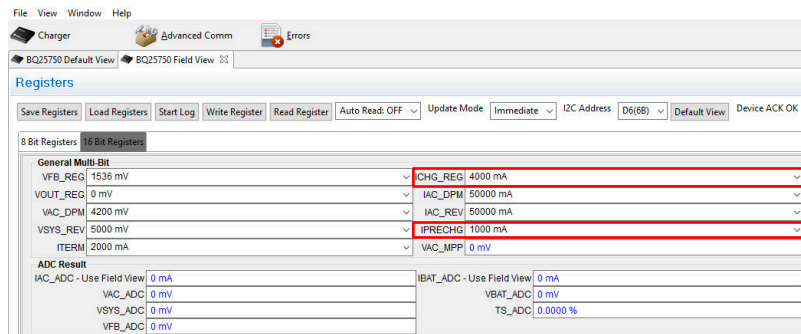

10. If using TI Charger GUI, use the following steps:
  - a. Connect J4 to the USB2ANY. Turn on the computer and load 2.
  - b. Navigate to the [TI Charger GUI website](#) and select the charger you are using:



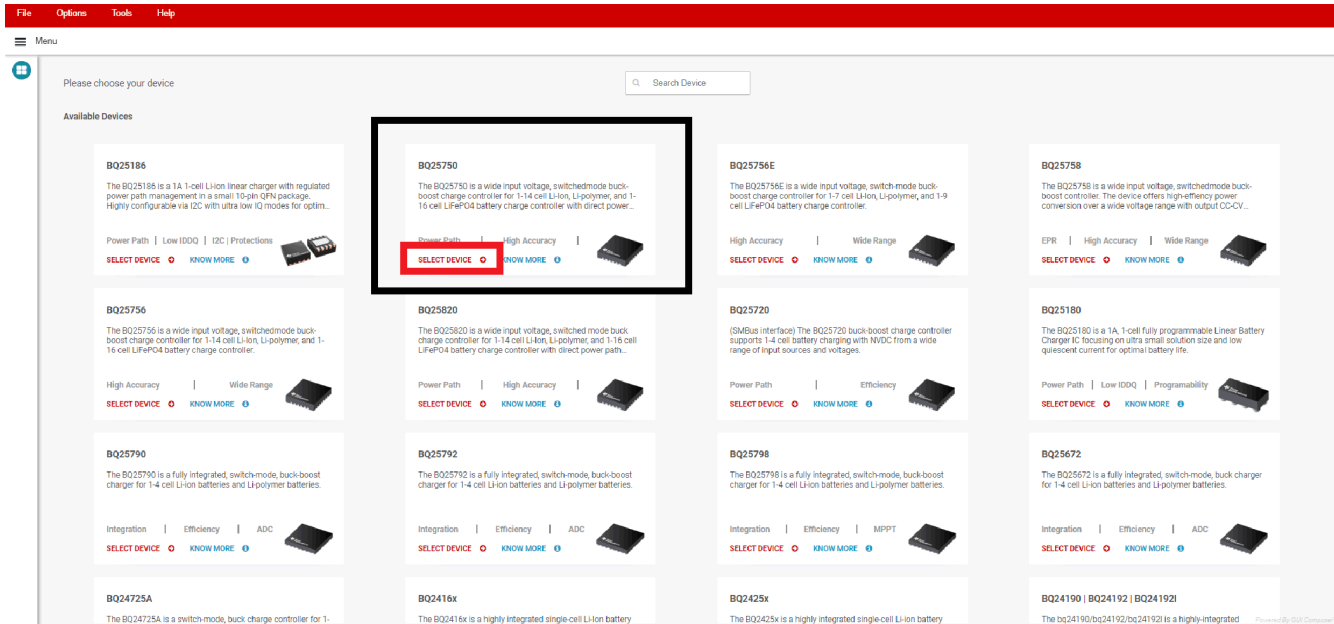

c. You should see at the top-left, Hardware Connected. After you see the hardware is connected, select the plug icon on the left panel.





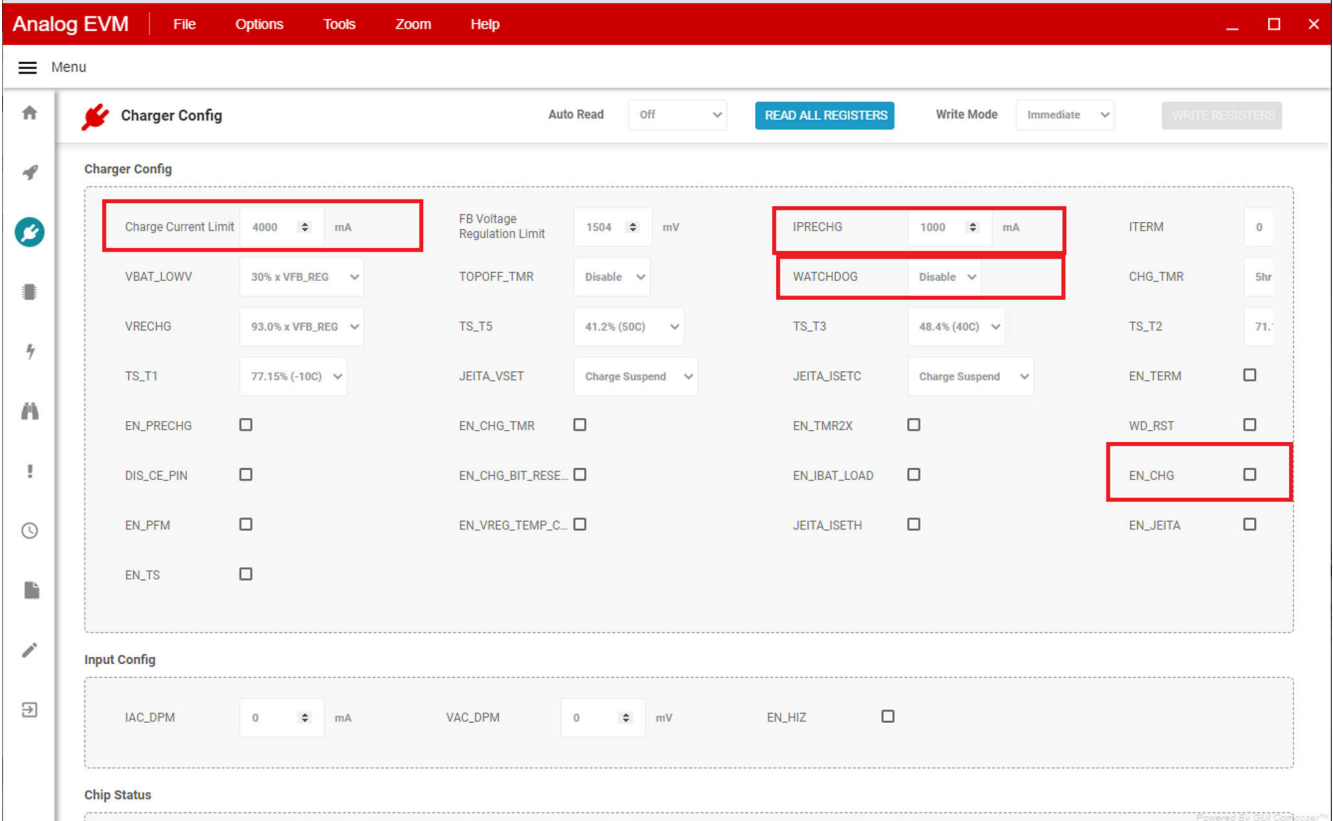





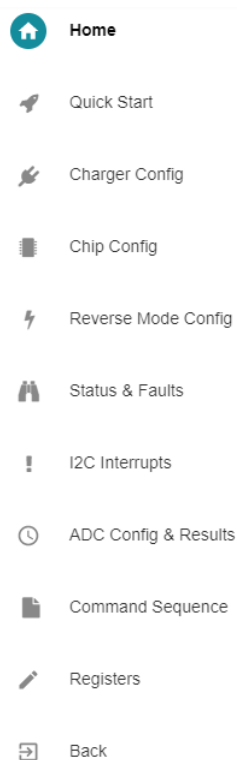



d. This is the Charger Configuration window. Click the Read All Register button at the top, then set WATCHDOG and EN\_CHG to disabled. Set ICHG\_REG to 4000mA and IPRECHG to 1000mA.



The screenshot shows the 'Charger Config' page in the Analog EVM software. The 'Charge Current Limit' is set to 4000 mA. The 'FB Voltage Regulation Limit' is 1504 mV. The 'IPRECHG' is set to 1000 mA. The 'WATCHDOG' is set to 'Disable'. The 'EN\_CHG' checkbox is highlighted with a red box. The 'Input Config' section shows 'IAC\_DPM' at 0 mA, 'VAC\_DPM' at 0 mV, and 'EN\_HIZ' unchecked. The 'Chip Status' section is at the bottom.

- e. Here is a brief description of what the other icons on the left side panel mean. Select through these icons to configure other operations of the battery charger.



-  Home
-  Quick Start
-  Charger Config
-  Chip Config
-  Reverse Mode Config
-  Status & Faults
-  I2C Interrupts
-  ADC Config & Results
-  Command Sequence
-  Registers
-  Back

11. Set EN\_CHG to enabled and plug in Jumper 13.
12. Set power supply 1 to 40V, measure:

$$V(J1(VAC)) = 40V \pm 0.5V$$

$$I(J1(IAC)) = 1.2A \pm 0.5A$$

$$V(J3(VBAT)) = 23.5V \pm 0.5V$$

$$I(J3(IBAT)) = 2A \pm 0.5A$$

13. Set power supply 1 for 23V, measure:

$$V(J1(VAC)) = 23V \pm 0.5V$$

$$I(J1(IAC)) = 2.1A \pm 0.5A$$

$$V(J3(VBAT)) = 23.5V \pm 0.5V$$

$$I(J3(IBAT)) = 2A \pm 0.5A$$

14. Set power supply 1 for 10V, measure:

$$V(J1(VAC)) = 10V \pm 0.5V$$

$$I(J1(IAC)) = 5A \pm 0.5A$$

$$V(J3(VBAT)) = 23.5V \pm 0.5V$$

$$I(J3(IBAT)) = 2A \pm 0.5A$$

Use the following guidelines to test the BQ25750 EVM power path:

1. Disconnect the power supply from J1 (VIN and PGND) and disconnect Load 1 from J3 (VOUT and PGND).
2. Connect the output of power supply 1 to J3 (VOUT and PGND).
3. Set power supply 1 for 20V DC, 8A current limit and then turn off power supply.
4. Connect a voltage meter across J2 (VSYS) and J2 (PGND).
5. Turn on power supply 1, measure  $V(J2(VSYS)) = 20V \pm 0.5V$ .



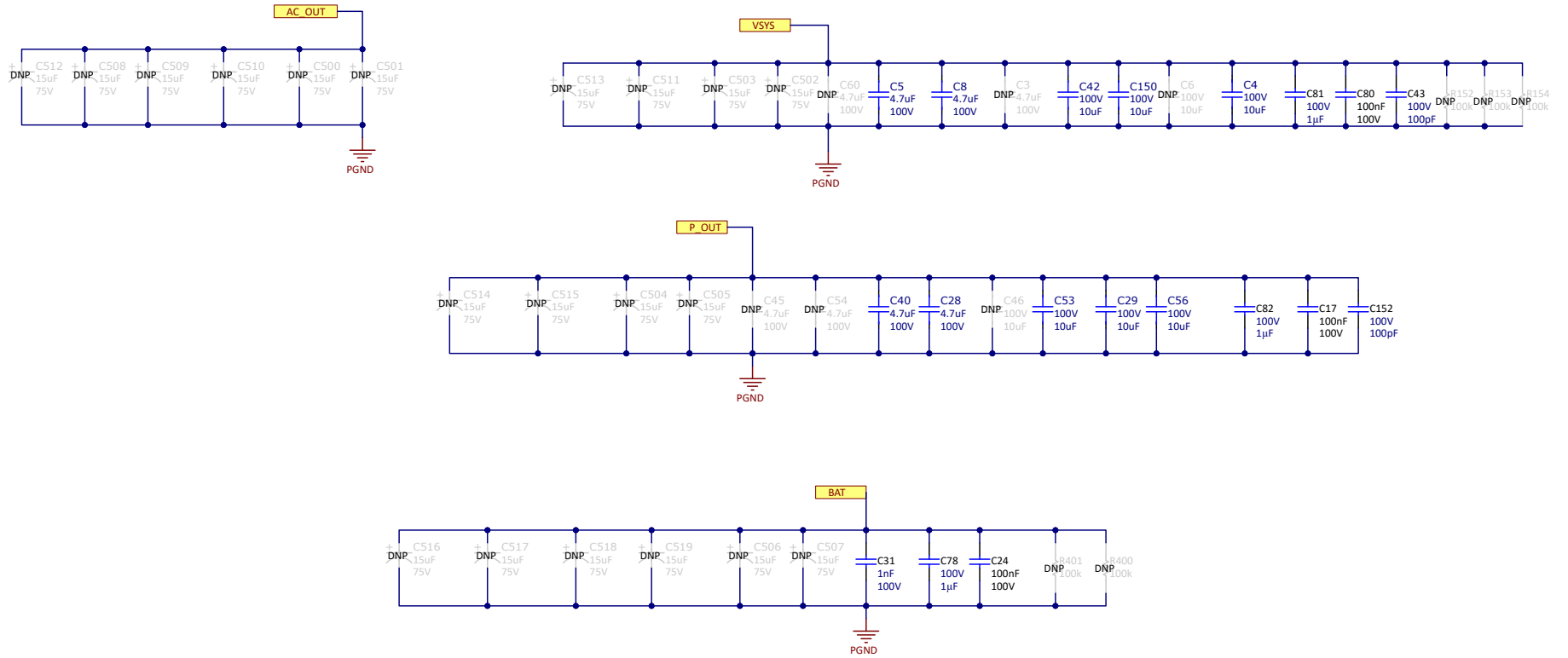

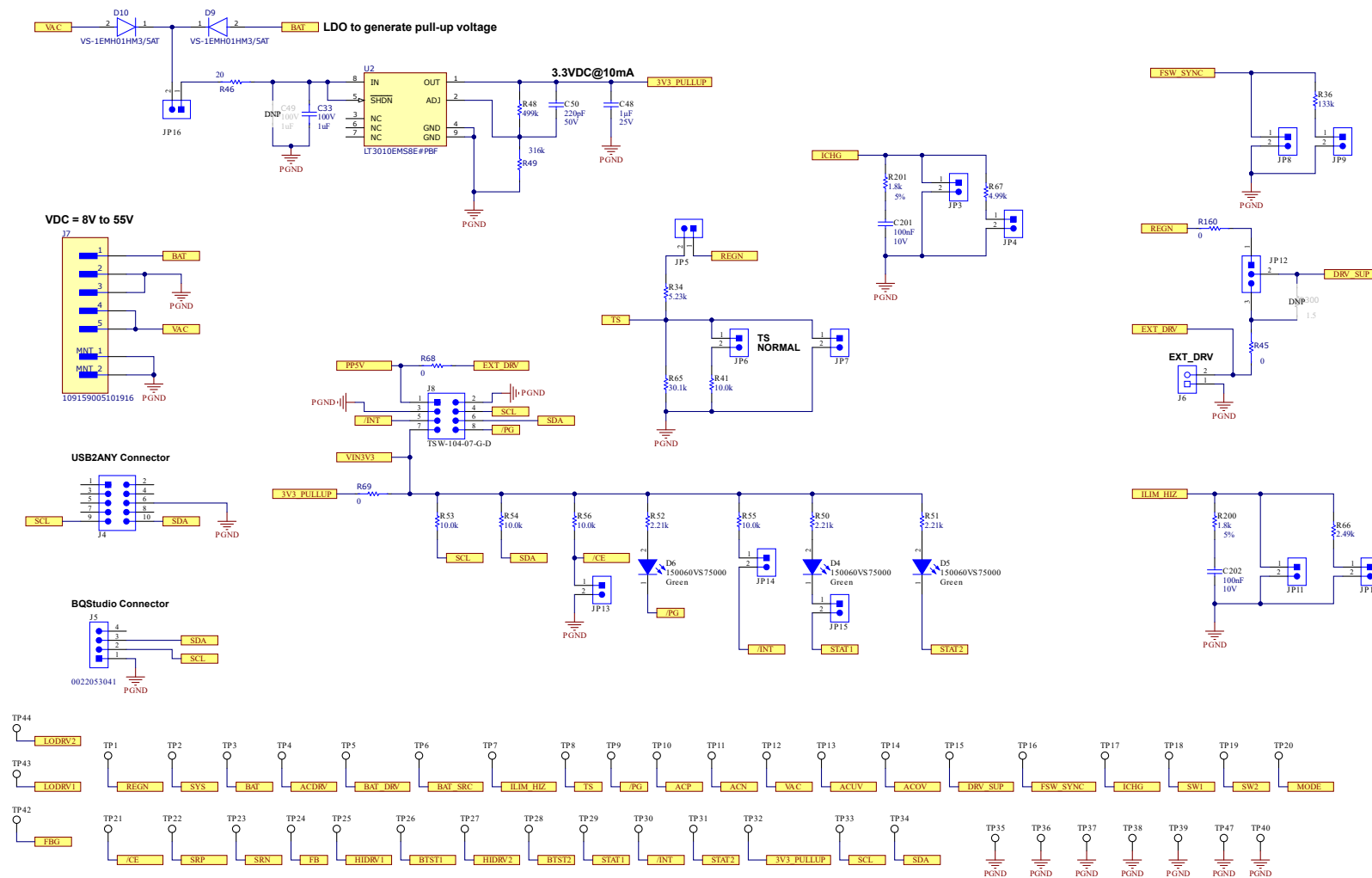

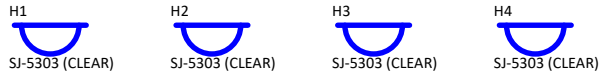
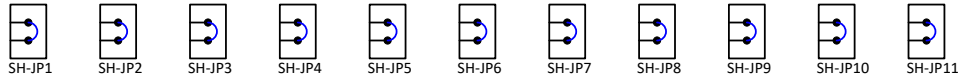

LOGO3  
PCB  
LOGO  
CAUTION. READ USER GUIDE BEFORE USE

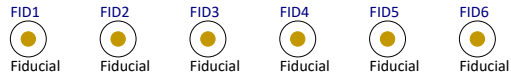

LOGO4  
PCB  
LOGO  
Texas Instruments



LOGO6  
PCB  
LOGO  
FCC disclaimer

LOGO7  
PCB  
LOGO  
WEEE logo

PCB Number: BMS042  
PCB Rev: A

LBL1  
PCB Label  
THT-14-423-10

Label Table	
Variant	LBL1 Label Text
BQ25750	BQ25750EVM
BQ25751	
BQ25756	BQ25756EVM
BQ25820	
BQ25758	BQ25758EVM

ZZ1  
Assembly Note

These assemblies are ESD sensitive, ESD precautions shall be observed.

ZZ2  
Assembly Note

These assemblies must be clean and free from flux and all contaminants. Use of no clean flux is not acceptable.

ZZ3  
Assembly Note

These assemblies must comply with workmanship standards IPC-A-610 Class 2, unless otherwise specified.

ZZ4  
Assembly Note

Install label in silkscreened box after final wash. Text shall be 8 pt font. Text shall be per the Label Table in the PDF schematic.

ZZ5  
Assembly Note

For BQ25750 variant, Install JP1, JP4, JP5, JP6, JP9, JP10, pin 1-2 of JP12, JP13, JP14, JP15, and JP16

ZZ6  
Assembly Note

For BQ25758 variant, Install JP4, JP5, JP6, JP9, JP10, pin 1-2 of JP12, JP13, JP14, JP15, and JP16

ZZ7  
Assembly Note

For BQ25756 variant, Install JP1, JP4, JP5, JP6, JP9, JP10, pin 1-2 of JP12, JP13, JP14, JP15, and JP16

1. DNP means *Do Not Populate*.





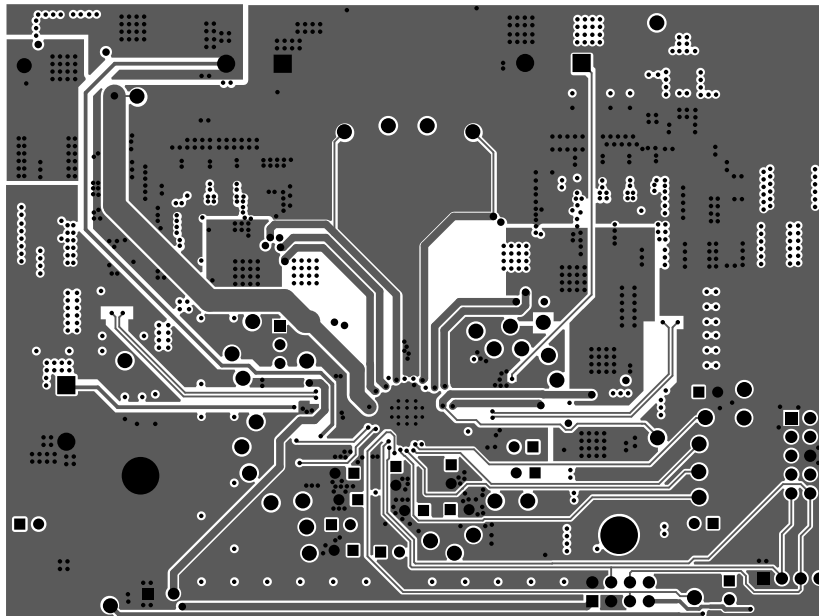

**Figure 3-4. Signal Layer 1**

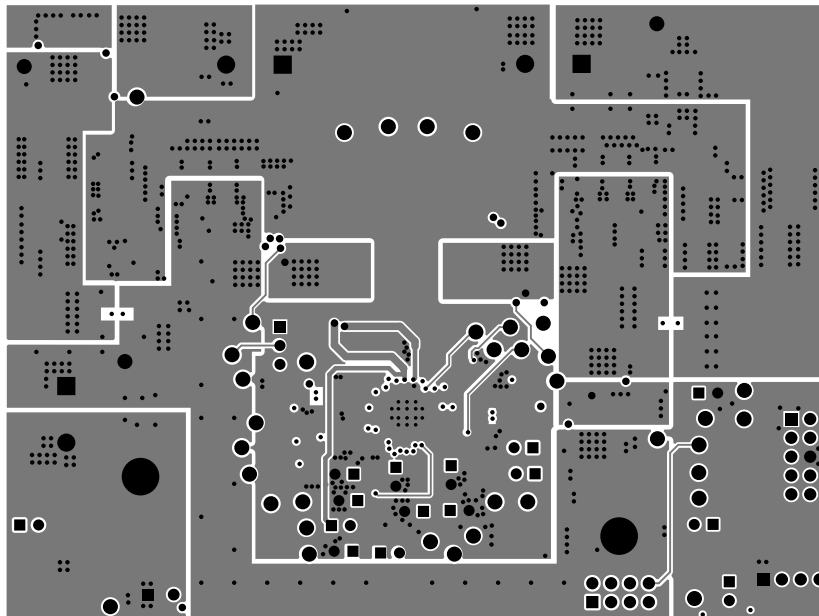

**Figure 3-5. Signal Layer 2**

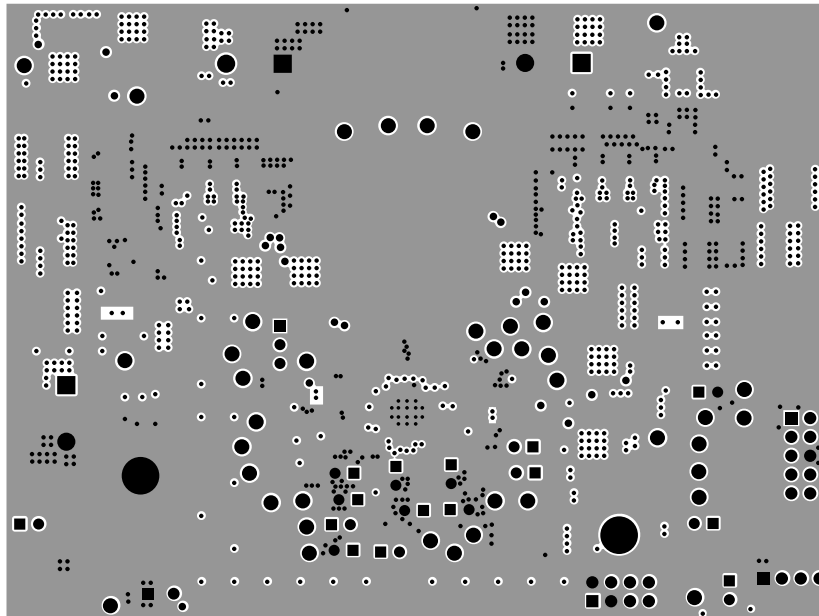

Figure 3-6. Layer 5 - GND

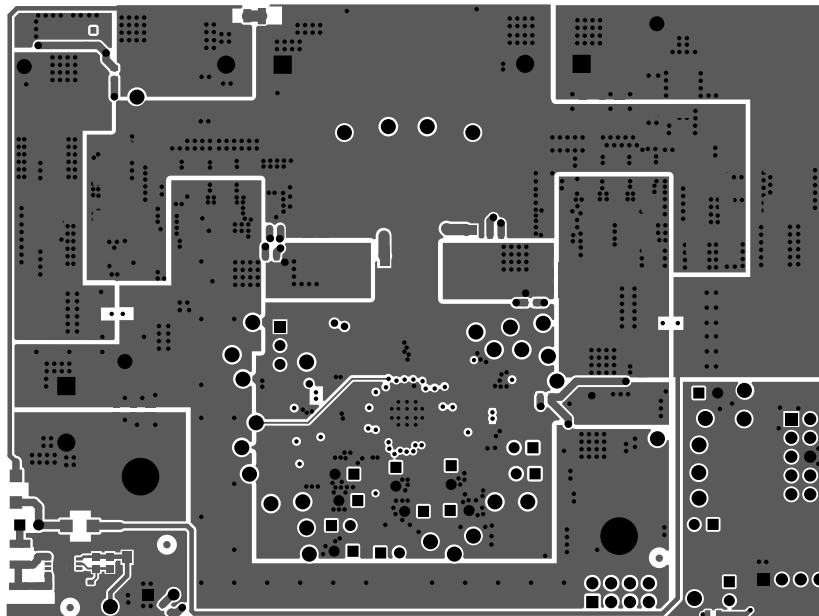

Figure 3-7. Bottom Layer

### 3.3 Bill of Materials (BOM)

**Table 3-1. Bill of Materials (BOM)**

Item Number	Designator	Quantity	Value	Part Number	Manufacturer	Description	Package Reference
1	C2, C5, C8, C28, C40	5	4.7 $\mu$ F	GCJ32DC72A475KE01L	Murata	4.7uF $\pm$ 10% 100V Ceramic Capacitor X7S 1210 (3225 Metric)	1210
2	C4, C29, C42, C53, C56, C150	6	10 $\mu$ F	C3225X7R2A106K250AC	TDK	10 $\mu$ F $\pm$ 10% 100V Ceramic Capacitor X7R 1210 (3225 Metric)	1210
3	C7, C38, C39, C44, C57, C70	6	56 $\mu$ F	80SXV56M	Panasonic	56 $\mu$ F 80 V Aluminum - Polymer Capacitors Radial, Can - SMD 28mOhm 1000 Hrs @ 125°C	SMT_CAP_10MM3_10MM3
4	C10, C11, C17, C19, C21, C23, C24, C63, C80, C200	10	0.1 $\mu$ F	HMK107B7104KAHT	Taiyo Yuden	CAP, CERM, 0.1 $\mu$ F, 100 V, +/- 10%, X7R, AEC-Q200 Grade 1, 0603	603
5	C12, C18	2	0.1 $\mu$ F	06033C104KAT2A	AVX	CAP, CERM, 0.1 uF, 25 V, +/- 10%, X7R, 0603	603
6	C13	1		CGA6N3X7R2A225K230AE	TDK Corporation	Cap Ceramic 2.2uF 100V X7R 10% SMD 1210 FlexiTerm 125C Plastic T/R	1210
7	C16, C77, C78, C81, C82	5	1 $\mu$ F	08051C105K4Z2A	AVX	CAP, CERM, 1 $\mu$ F, 100 V, +/- 10%, X7R, AEC-Q200 Grade 1, 0805	805
8	C22, C26	2	4.7 $\mu$ F	CGA4J1X7R1E475K125AE	TDK Corporation	Cap Ceramic 4.7uF 25V X7R 10% Pad SMD 0805 +125°C Automotive T/R	805
9	C31, C151	2	1000pF	CGA3E2X7R2A102K080AA	TDK	Multilayer Ceramic Capacitors MLCC - SMD/SMT CGA 0603 100V 1000pF X7R 10% AEC-Q200	603
10	C33	1	1 $\mu$ F	12101C105KAT2A	AVX	General Purpose Ceramic Capacitor, 1210, 1uF, 10%, X7R, 15%, 100V	1210
11	C34, C35	2	0.47 $\mu$ F	C0603C474K4RACTU	Kemet	CAP, CERM, 0.47 uF, 16 V, +/- 10%, X7R, 0603	603
12	C43, C152	2	100pF	CGA3E2C0G2A101J080AA	TDK	Multilayer Ceramic Capacitors MLCC - SMD/SMT CGA 0603 100V 100pF C0G 5% AEC-Q200	603
13	C48	1	1 $\mu$ F	C0805C105K3RACTU	Kemet	CAP, CERM, 1 uF, 25 V, +/- 10%, X7R, 0805	805
14	C50	1	220pF	C0603C221K5RACTU	Kemet	CAP, CERM, 220 pF, 50 V, +/- 10%, X7R, 0603	603
15	C201, C202	2	0.1 $\mu$ F	C0603C104K8RACTU	Kemet	CAP, CERM, 0.1 uF, 10 V, +/- 10%, X7R, 0603	603
16	D1	1		SZBZX84C15LT3G	On Semiconductor	Zener Diode Single 15V 5% 300hm 300mW Automotive 3-Pin SOT-23 T/R	SOT23
17	D2, D3	2		V1FM10-M3/H	Vishay	Diode Schottky 1A Surface Mount DO-219AB (SMF)	DO-219AB
18	D4, D5, D6	3	Green	150060VS75000	Würth Elektronik	LED, Green, SMD	LED_0603

**Table 3-1. Bill of Materials (BOM) (continued)**

Item Number	Designator	Quantity	Value	Part Number	Manufacturer	Description	Package Reference
19	D9, D10	2		VS-1EMH01HM3/5AT	Vishay	Diode Standard 100 V 1A Surface Mount DO-214AC (SMA)	DO-214AC
20	FID1, FID2, FID3, FID4, FID5, FID6	6		N/A	N/A	Fiducial mark. There is nothing to buy or mount.	N/A
21	H1, H2, H3, H4	4		SJ-5303 (CLEAR)	3M	Bumpon, Hemisphere, 0.44 X 0.20, Clear	Transparent Bumpon
22	J1, J2, J3	3		TB005-762-02BE	CUI Devices		TERM_CONN
23	J4	1		N2510-6002-RB	3M	Header (shrouded), 100mil, 5x2, High-Temperature, Gold, TH	5x2 Shrouded header
24	J5	1		22053041	Molex	Header (friction lock), 100mil, 4x1, R/A, TH	4x1 R/A Header
25	J6	1		393570002	Molex	Terminal Block, 3.5 mm, 2x1, Tin, TH	Terminal Block, 3.5 mm, 2x1, TH
26	J7	1		1.09159E+14	KYOCERA AVX	Conn Board to Board HDR 5 POS 3mm Solder RA SMD T/R	CONN_SSL_PLUG5
27	J8	1		TSW-104-07-G-D	Samtec	Header, 100mil, 4x2, Gold, TH	4x2 Header
28	JP1, JP2, JP3, JP4, JP5, JP6, JP7, JP8, JP9, JP10, JP11, JP13, JP14, JP15, JP16	15		PEC02SAAN	Sullins Connector Solutions	Header, 100mil, 2x1, Tin, TH	Header, 2 PIN, 100mil, Tin
29	JP12	1		PEC03SAAN	Sullins Connector Solutions	Header, 100mil, 3x1, Tin, TH	Header, 3 PIN, 100mil, Tin
30	L1	1	10uH	IHLP6767GZER100M01	Vishay	Commercial Inductors, High Saturation Series 10uH 16.5A 12mΩ 20%	SMT_INDUCTOR_17MM15_17M M15
31	LBL1	1		THT-14-423-10	Brady	Thermal Transfer Printable Labels, 0.650" W x 0.200" H - 10,000 per roll	PCB Label 0.650 x 0.200 inch
32	PCB1	1		BMS042	Any	Printed Circuit Board	
33	Q1, Q2, Q3, Q4	4		AONS66920	Alpha & Omega Semiconductor	N-Channel 100 V 48A (Tc) 56.5W (Tc) Surface Mount 8-DFN-EP (5x6)	DFN8
34	Q5, Q6, Q7, Q8	4		AONS66917	Alpha & Omega Semiconductor	100V N-Channel MOSFET, DFN5x6-8L, RoHS	DFN8
35	R2	1	2m	WSLF25122L000FEA	Vishay	2 mOhms ±1% 6W Chip Resistor 2512 (6432 Metric) Automotive AEC-Q200, Current Sense, Moisture Resistant, Pulse Withstanding Metal Element	2512
36	R3, R8, R9, R12, R13, R17, R20, R23, R68, R69, R100, R160	12	0	CRCW06030000Z0EA	Vishay	Thick Film Resistors - SMD 1/10watt ZEROohm Jumper	603

**Table 3-1. Bill of Materials (BOM) (continued)**

Item Number	Designator	Quantity	Value	Part Number	Manufacturer	Description	Package Reference
37	R5, R6, R22, R25	4	10	CRCW060310R0FKEB	Vishay	RES Thick Film, 10Ω, 1%, 0.1W, 100ppm/°C, 0603	603
38	R10	1	10	CRCW120610R0FKEAHP	Vishay Dale	RES Thick Film, 10Ω, 1%, 0.75W, 100ppm/°C, 1206	1206
39	R21	1	1.00Meg	CRCW08051M00FKEAC	Vishay / Dale	Thick Film Resistors - SMD 1/8Watt 1Mohms 1% Commercial Use	805
40	R24	1	5m	FCSL110R005FER	Ohmite	5 mOhms ±1% 5W Chip Resistor Wide 4320 (11050 Metric), 2043 Current Sense, Moisture Resistant Metal Foil	WIDE_4320
41	R27	1	133k	ERJ-6ENF1333V	Panasonic	RES, 133 k, 1%, 0.125 W, AEC-Q200 Grade 0, 0805	805
42	R28	1	249k	ERJ-PB6B2493V	Panasonic	Thick Film Resistors - SMD 0805 Anti-Surge Res. 0.1%, 249Kohm	805
43	R30	1	25.5k	ERJ-6ENF2552V	Panasonic	RES, 25.5 k, 1%, 0.125 W, AEC-Q200 Grade 0, 0805	805
44	R32	1	3.00k	ERJ-6ENF3001V	Panasonic	RES, 3.00 k, 1%, 0.125 W, AEC-Q200 Grade 0, 0805	805
45	R34	1	5.23k	RC0603FR-075K23L	Yageo	RES, 5.23 k, 1%, 0.1 W, 0603	603
46	R36	1	133k	CRCW0603133KFKEA	Vishay-Dale	RES, 133 k, 1%, 0.1 W, AEC-Q200 Grade 0, 0603	603
47	R41, R53, R54, R55, R56	5	10.0k	RC0603FR-0710KL	Yageo	RES, 10.0 k, 1%, 0.1 W, 0603	603
48	R45, R120	2	0	CRCW08050000Z0EA	Vishay	Thick Film Resistors - SMD 1/8watt ZEROohm Jumper	805
49	R46	1	20	CRCW121020R0FKEAHP	Vishay Dale	Thick Film Resistors - SMD 3/4watt 20ohms 1% High Power AEC-Q200	1210
50	R48	1	499k	RC0603FR-07499KL	Yageo	RES, 499 k, 1%, 0.1 W, 0603	603
51	R49	1	316k	CR0603-FX-3163ELF	Bourns	Thick Film Chip Resistors 0603 316kΩ 0.1W 1% 100ppm/°C	603
52	R50, R51, R52	3	2.21k	RC0603FR-072K21L	Yageo	RES, 2.21 k, 1%, 0.1 W, 0603	603
53	R64	1	13.7k	RG2012P-1372-B-T5	Susumu Co Ltd	RES, 13.7 k, 0.1%, 0.125 W, 0805	805
54	R65	1	30.1k	RC0603FR-0730K1L	Yageo	RES, 30.1 k, 1%, 0.1 W, 0603	603
55	R66	1	2.49k	RC0603FR-072K49L	Yageo	RES, 2.49 k, 1%, 0.1 W, 0603	603
56	R67	1	4.99k	CRCW06034K99FKEAC	Vishay-Dale	RES, 4.99 k, 1%, 0.1 W, 0603	603
57	R200, R201	2	1.8k	RC0603JR-071K8L	Yageo	RES, 1.8 k, 5%, 0.1 W, 0603	603

**Table 3-1. Bill of Materials (BOM) (continued)**

Item Number	Designator	Quantity	Value	Part Number	Manufacturer	Description	Package Reference
58	SH-JP1, SH-JP2, SH-JP3, SH-JP4, SH-JP5, SH-JP6, SH-JP7, SH-JP8, SH-JP9, SH-JP10, SH-JP11	11	1x2	SNT-100-BK-G	Samtec	Shunt, 100mil, Gold plated, Black	Shunt
59	TP1, TP2, TP3, TP4, TP5, TP6, TP7, TP8, TP9, TP10, TP11, TP12, TP13, TP14, TP15, TP16, TP17, TP18, TP19, TP20, TP21, TP22, TP23, TP24, TP25, TP26, TP27, TP28, TP29, TP30, TP31, TP32, TP33, TP34, TP41, TP42, TP43, TP44, TP45, TP46	40		5002	Keystone	Test Point, Miniature, White, TH	White Miniature Testpoint
60	TP35, TP36, TP37, TP38, TP39, TP40, TP47	7		5016	Keystone	Test Point, Compact, SMT	Testpoint_Keystone_Compact
61	U1	1		BQ25750RRVT	Texas Instruments	Standalone/I2C Controlled, 70V, 20A Buck-Boost Multi-Chemistry Battery Charge Controller	VQFN36
62	U2	1		LT3010EMS8E-PBF	Analog Devices	Linear Voltage Regulator IC Positive Adjustable 1 Output 50mA 8-MSOP-EP	MSOP8

## 4 Additional Information

### 4.1 Trademarks

Microsoft® and Windows® are registered trademarks of Microsoft Corporation.  
All trademarks are the property of their respective owners.

## 5 Revision History

NOTE: Page numbers for previous revisions may differ from page numbers in the current version.

<b>Changes from Revision A (October 2024) to Revision B (May 2025)</b>	<b>Page</b>
• Updated Caution with guidelines for batteries with voltages greater than 30V.....	1
• Updated schematic.....	20

<b>Changes from Revision * (November 2023) to Revision A (October 2024)</b>	<b>Page</b>
• Added instructions for turning on the device.....	10

## STANDARD TERMS FOR EVALUATION MODULES

1. *Delivery:* TI delivers TI evaluation boards, kits, or modules, including any accompanying demonstration software, components, and/or documentation which may be provided together or separately (collectively, an "EVM" or "EVMs") to the User ("User") in accordance with the terms set forth herein. User's acceptance of the EVM is expressly subject to the following terms.
  - 1.1 EVMs are intended solely for product or software developers for use in a research and development setting to facilitate feasibility evaluation, experimentation, or scientific analysis of TI semiconductor products. EVMs have no direct function and are not finished products. EVMs shall not be directly or indirectly assembled as a part or subassembly in any finished product. For clarification, any software or software tools provided with the EVM ("Software") shall not be subject to the terms and conditions set forth herein but rather shall be subject to the applicable terms that accompany such Software
  - 1.2 EVMs are not intended for consumer or household use. EVMs may not be sold, sublicensed, leased, rented, loaned, assigned, or otherwise distributed for commercial purposes by Users, in whole or in part, or used in any finished product or production system.
2. *Limited Warranty and Related Remedies/Disclaimers:*
  - 2.1 These terms do not apply to Software. The warranty, if any, for Software is covered in the applicable Software License Agreement.
  - 2.2 TI warrants that the TI EVM will conform to TI's published specifications for ninety (90) days after the date TI delivers such EVM to User. Notwithstanding the foregoing, TI shall not be liable for a nonconforming EVM if (a) the nonconformity was caused by neglect, misuse or mistreatment by an entity other than TI, including improper installation or testing, or for any EVMs that have been altered or modified in any way by an entity other than TI, (b) the nonconformity resulted from User's design, specifications or instructions for such EVMs or improper system design, or (c) User has not paid on time. Testing and other quality control techniques are used to the extent TI deems necessary. TI does not test all parameters of each EVM. User's claims against TI under this Section 2 are void if User fails to notify TI of any apparent defects in the EVMs within ten (10) business days after delivery, or of any hidden defects with ten (10) business days after the defect has been detected.
  - 2.3 TI's sole liability shall be at its option to repair or replace EVMs that fail to conform to the warranty set forth above, or credit User's account for such EVM. TI's liability under this warranty shall be limited to EVMs that are returned during the warranty period to the address designated by TI and that are determined by TI not to conform to such warranty. If TI elects to repair or replace such EVM, TI shall have a reasonable time to repair such EVM or provide replacements. Repaired EVMs shall be warranted for the remainder of the original warranty period. Replaced EVMs shall be warranted for a new full ninety (90) day warranty period.

### **WARNING**

**Evaluation Kits are intended solely for use by technically qualified, professional electronics experts who are familiar with the dangers and application risks associated with handling electrical mechanical components, systems, and subsystems.**

**User shall operate the Evaluation Kit within TI's recommended guidelines and any applicable legal or environmental requirements as well as reasonable and customary safeguards. Failure to set up and/or operate the Evaluation Kit within TI's recommended guidelines may result in personal injury or death or property damage. Proper set up entails following TI's instructions for electrical ratings of interface circuits such as input, output and electrical loads.**

**NOTE:**

**EXPOSURE TO ELECTROSTATIC DISCHARGE (ESD) MAY CAUSE DEGRADATION OR FAILURE OF THE EVALUATION KIT; TI RECOMMENDS STORAGE OF THE EVALUATION KIT IN A PROTECTIVE ESD BAG.**



### 3 Regulatory Notices:

#### 3.1 United States

##### 3.1.1 Notice applicable to EVMs not FCC-Approved:

**FCC NOTICE:** This kit is designed to allow product developers to evaluate electronic components, circuitry, or software associated with the kit to determine whether to incorporate such items in a finished product and software developers to write software applications for use with the end product. This kit is not a finished product and when assembled may not be resold or otherwise marketed unless all required FCC equipment authorizations are first obtained. Operation is subject to the condition that this product not cause harmful interference to licensed radio stations and that this product accept harmful interference. Unless the assembled kit is designed to operate under part 15, part 18 or part 95 of this chapter, the operator of the kit must operate under the authority of an FCC license holder or must secure an experimental authorization under part 5 of this chapter.

##### 3.1.2 For EVMs annotated as FCC – FEDERAL COMMUNICATIONS COMMISSION Part 15 Compliant:

#### **CAUTION**

This device complies with part 15 of the FCC Rules. Operation is subject to the following two conditions: (1) This device may not cause harmful interference, and (2) this device must accept any interference received, including interference that may cause undesired operation.

Changes or modifications not expressly approved by the party responsible for compliance could void the user's authority to operate the equipment.

#### **FCC Interference Statement for Class A EVM devices**

*NOTE: This equipment has been tested and found to comply with the limits for a Class A digital device, pursuant to part 15 of the FCC Rules. These limits are designed to provide reasonable protection against harmful interference when the equipment is operated in a commercial environment. This equipment generates, uses, and can radiate radio frequency energy and, if not installed and used in accordance with the instruction manual, may cause harmful interference to radio communications. Operation of this equipment in a residential area is likely to cause harmful interference in which case the user will be required to correct the interference at his own expense.*

#### **FCC Interference Statement for Class B EVM devices**

*NOTE: This equipment has been tested and found to comply with the limits for a Class B digital device, pursuant to part 15 of the FCC Rules. These limits are designed to provide reasonable protection against harmful interference in a residential installation. This equipment generates, uses and can radiate radio frequency energy and, if not installed and used in accordance with the instructions, may cause harmful interference to radio communications. However, there is no guarantee that interference will not occur in a particular installation. If this equipment does cause harmful interference to radio or television reception, which can be determined by turning the equipment off and on, the user is encouraged to try to correct the interference by one or more of the following measures:*

- Reorient or relocate the receiving antenna.
- Increase the separation between the equipment and receiver.
- Connect the equipment into an outlet on a circuit different from that to which the receiver is connected.
- Consult the dealer or an experienced radio/TV technician for help.

#### 3.2 Canada

##### 3.2.1 For EVMs issued with an Industry Canada Certificate of Conformance to RSS-210 or RSS-247

#### **Concerning EVMs Including Radio Transmitters:**

This device complies with Industry Canada license-exempt RSSs. Operation is subject to the following two conditions:

(1) this device may not cause interference, and (2) this device must accept any interference, including interference that may cause undesired operation of the device.

#### **Concernant les EVMs avec appareils radio:**

Le présent appareil est conforme aux CNR d'Industrie Canada applicables aux appareils radio exempts de licence. L'exploitation est autorisée aux deux conditions suivantes: (1) l'appareil ne doit pas produire de brouillage, et (2) l'utilisateur de l'appareil doit accepter tout brouillage radioélectrique subi, même si le brouillage est susceptible d'en compromettre le fonctionnement.

#### **Concerning EVMs Including Detachable Antennas:**

Under Industry Canada regulations, this radio transmitter may only operate using an antenna of a type and maximum (or lesser) gain approved for the transmitter by Industry Canada. To reduce potential radio interference to other users, the antenna type and its gain should be so chosen that the equivalent isotropically radiated power (e.i.r.p.) is not more than that necessary for successful communication. This radio transmitter has been approved by Industry Canada to operate with the antenna types listed in the user guide with the maximum permissible gain and required antenna impedance for each antenna type indicated. Antenna types not included in this list, having a gain greater than the maximum gain indicated for that type, are strictly prohibited for use with this device.

### Concernant les EVMs avec antennes détachables

Conformément à la réglementation d'Industrie Canada, le présent émetteur radio peut fonctionner avec une antenne d'un type et d'un gain maximal (ou inférieur) approuvé pour l'émetteur par Industrie Canada. Dans le but de réduire les risques de brouillage radioélectrique à l'intention des autres utilisateurs, il faut choisir le type d'antenne et son gain de sorte que la puissance isotrope rayonnée équivalente (p.i.r.e.) ne dépasse pas l'intensité nécessaire à l'établissement d'une communication satisfaisante. Le présent émetteur radio a été approuvé par Industrie Canada pour fonctionner avec les types d'antenne énumérés dans le manuel d'usage et ayant un gain admissible maximal et l'impédance requise pour chaque type d'antenne. Les types d'antenne non inclus dans cette liste, ou dont le gain est supérieur au gain maximal indiqué, sont strictement interdits pour l'exploitation de l'émetteur.

#### 3.3 Japan

3.3.1 *Notice for EVMs delivered in Japan:* Please see [http://www.tij.co.jp/lstds/ti\\_ja/general/eStore/notice\\_01.page](http://www.tij.co.jp/lstds/ti_ja/general/eStore/notice_01.page) 日本国内に輸入される評価用キット、ボードについては、次のところをご覧ください。

<https://www.ti.com/ja-jp/legal/notice-for-evaluation-kits-delivered-in-japan.html>

3.3.2 *Notice for Users of EVMs Considered "Radio Frequency Products" in Japan:* EVMs entering Japan may not be certified by TI as conforming to Technical Regulations of Radio Law of Japan.

If User uses EVMs in Japan, not certified to Technical Regulations of Radio Law of Japan, User is required to follow the instructions set forth by Radio Law of Japan, which includes, but is not limited to, the instructions below with respect to EVMs (which for the avoidance of doubt are stated strictly for convenience and should be verified by User):

1. Use EVMs in a shielded room or any other test facility as defined in the notification #173 issued by Ministry of Internal Affairs and Communications on March 28, 2006, based on Sub-section 1.1 of Article 6 of the Ministry's Rule for Enforcement of Radio Law of Japan,
2. Use EVMs only after User obtains the license of Test Radio Station as provided in Radio Law of Japan with respect to EVMs, or
3. Use of EVMs only after User obtains the Technical Regulations Conformity Certification as provided in Radio Law of Japan with respect to EVMs. Also, do not transfer EVMs, unless User gives the same notice above to the transferee. Please note that if User does not follow the instructions above, User will be subject to penalties of Radio Law of Japan.

【無線電波を送信する製品の開発キットをお使いになる際の注意事項】 開発キットの中には技術基準適合証明を受けていないものがあります。技術適合証明を受けていないものご使用に際しては、電波法遵守のため、以下のいずれかの措置を取っていただく必要がありますのでご注意ください。

1. 電波法施行規則第6条第1項第1号に基づく平成18年3月28日総務省告示第173号で定められた電波暗室等の試験設備でご使用いただく。
2. 実験局の免許を取得後ご使用いただく。
3. 技術基準適合証明を取得後ご使用いただく。

なお、本製品は、上記の「ご使用にあたっての注意」を譲渡先、移転先に通知しない限り、譲渡、移転できないものとします。

上記を遵守頂けない場合は、電波法の罰則が適用される可能性があることをご留意ください。日本テキサス・イ

ンスツルメンツ株式会社

東京都新宿区西新宿 6 丁目 2 4 番 1 号

西新宿三井ビル

3.3.3 *Notice for EVMs for Power Line Communication:* Please see [http://www.tij.co.jp/lstds/ti\\_ja/general/eStore/notice\\_02.page](http://www.tij.co.jp/lstds/ti_ja/general/eStore/notice_02.page)

電力線搬送波通信についての開発キットをお使いになる際の注意事項については、次のところをご覧ください。 <https://www.ti.com/ja-jp/legal/notice-for-evaluation-kits-for-power-line-communication.html>

#### 3.4 European Union

3.4.1 *For EVMs subject to EU Directive 2014/30/EU (Electromagnetic Compatibility Directive):*

This is a class A product intended for use in environments other than domestic environments that are connected to a low-voltage power-supply network that supplies buildings used for domestic purposes. In a domestic environment this product may cause radio interference in which case the user may be required to take adequate measures.

- 
- 4 *EVM Use Restrictions and Warnings:*
    - 4.1 EVMS ARE NOT FOR USE IN FUNCTIONAL SAFETY AND/OR SAFETY CRITICAL EVALUATIONS, INCLUDING BUT NOT LIMITED TO EVALUATIONS OF LIFE SUPPORT APPLICATIONS.
    - 4.2 User must read and apply the user guide and other available documentation provided by TI regarding the EVM prior to handling or using the EVM, including without limitation any warning or restriction notices. The notices contain important safety information related to, for example, temperatures and voltages.
    - 4.3 *Safety-Related Warnings and Restrictions:*
      - 4.3.1 User shall operate the EVM within TI's recommended specifications and environmental considerations stated in the user guide, other available documentation provided by TI, and any other applicable requirements and employ reasonable and customary safeguards. Exceeding the specified performance ratings and specifications (including but not limited to input and output voltage, current, power, and environmental ranges) for the EVM may cause personal injury or death, or property damage. If there are questions concerning performance ratings and specifications, User should contact a TI field representative prior to connecting interface electronics including input power and intended loads. Any loads applied outside of the specified output range may also result in unintended and/or inaccurate operation and/or possible permanent damage to the EVM and/or interface electronics. Please consult the EVM user guide prior to connecting any load to the EVM output. If there is uncertainty as to the load specification, please contact a TI field representative. During normal operation, even with the inputs and outputs kept within the specified allowable ranges, some circuit components may have elevated case temperatures. These components include but are not limited to linear regulators, switching transistors, pass transistors, current sense resistors, and heat sinks, which can be identified using the information in the associated documentation. When working with the EVM, please be aware that the EVM may become very warm.
      - 4.3.2 EVMs are intended solely for use by technically qualified, professional electronics experts who are familiar with the dangers and application risks associated with handling electrical mechanical components, systems, and subsystems. User assumes all responsibility and liability for proper and safe handling and use of the EVM by User or its employees, affiliates, contractors or designees. User assumes all responsibility and liability to ensure that any interfaces (electronic and/or mechanical) between the EVM and any human body are designed with suitable isolation and means to safely limit accessible leakage currents to minimize the risk of electrical shock hazard. User assumes all responsibility and liability for any improper or unsafe handling or use of the EVM by User or its employees, affiliates, contractors or designees.
    - 4.4 User assumes all responsibility and liability to determine whether the EVM is subject to any applicable international, federal, state, or local laws and regulations related to User's handling and use of the EVM and, if applicable, User assumes all responsibility and liability for compliance in all respects with such laws and regulations. User assumes all responsibility and liability for proper disposal and recycling of the EVM consistent with all applicable international, federal, state, and local requirements.
  5. *Accuracy of Information:* To the extent TI provides information on the availability and function of EVMs, TI attempts to be as accurate as possible. However, TI does not warrant the accuracy of EVM descriptions, EVM availability or other information on its websites as accurate, complete, reliable, current, or error-free.
  6. *Disclaimers:*
    - 6.1 EXCEPT AS SET FORTH ABOVE, EVMS AND ANY MATERIALS PROVIDED WITH THE EVM (INCLUDING, BUT NOT LIMITED TO, REFERENCE DESIGNS AND THE DESIGN OF THE EVM ITSELF) ARE PROVIDED "AS IS" AND "WITH ALL FAULTS." TI DISCLAIMS ALL OTHER WARRANTIES, EXPRESS OR IMPLIED, REGARDING SUCH ITEMS, INCLUDING BUT NOT LIMITED TO ANY EPIDEMIC FAILURE WARRANTY OR IMPLIED WARRANTIES OF MERCHANTABILITY OR FITNESS FOR A PARTICULAR PURPOSE OR NON-INFRINGEMENT OF ANY THIRD PARTY PATENTS, COPYRIGHTS, TRADE SECRETS OR OTHER INTELLECTUAL PROPERTY RIGHTS.
    - 6.2 EXCEPT FOR THE LIMITED RIGHT TO USE THE EVM SET FORTH HEREIN, NOTHING IN THESE TERMS SHALL BE CONSTRUED AS GRANTING OR CONFERRING ANY RIGHTS BY LICENSE, PATENT, OR ANY OTHER INDUSTRIAL OR INTELLECTUAL PROPERTY RIGHT OF TI, ITS SUPPLIERS/LICENSORS OR ANY OTHER THIRD PARTY, TO USE THE EVM IN ANY FINISHED END-USER OR READY-TO-USE FINAL PRODUCT, OR FOR ANY INVENTION, DISCOVERY OR IMPROVEMENT, REGARDLESS OF WHEN MADE, CONCEIVED OR ACQUIRED.
  7. *USER'S INDEMNITY OBLIGATIONS AND REPRESENTATIONS.* USER WILL DEFEND, INDEMNIFY AND HOLD TI, ITS LICENSORS AND THEIR REPRESENTATIVES HARMLESS FROM AND AGAINST ANY AND ALL CLAIMS, DAMAGES, LOSSES, EXPENSES, COSTS AND LIABILITIES (COLLECTIVELY, "CLAIMS") ARISING OUT OF OR IN CONNECTION WITH ANY HANDLING OR USE OF THE EVM THAT IS NOT IN ACCORDANCE WITH THESE TERMS. THIS OBLIGATION SHALL APPLY WHETHER CLAIMS ARISE UNDER STATUTE, REGULATION, OR THE LAW OF TORT, CONTRACT OR ANY OTHER LEGAL THEORY, AND EVEN IF THE EVM FAILS TO PERFORM AS DESCRIBED OR EXPECTED.

8. *Limitations on Damages and Liability:*

8.1 *General Limitations.* IN NO EVENT SHALL TI BE LIABLE FOR ANY SPECIAL, COLLATERAL, INDIRECT, PUNITIVE, INCIDENTAL, CONSEQUENTIAL, OR EXEMPLARY DAMAGES IN CONNECTION WITH OR ARISING OUT OF THESE TERMS OR THE USE OF THE EVMS , REGARDLESS OF WHETHER TI HAS BEEN ADVISED OF THE POSSIBILITY OF SUCH DAMAGES. EXCLUDED DAMAGES INCLUDE, BUT ARE NOT LIMITED TO, COST OF REMOVAL OR REINSTALLATION, ANCILLARY COSTS TO THE PROCUREMENT OF SUBSTITUTE GOODS OR SERVICES, RETESTING, OUTSIDE COMPUTER TIME, LABOR COSTS, LOSS OF GOODWILL, LOSS OF PROFITS, LOSS OF SAVINGS, LOSS OF USE, LOSS OF DATA, OR BUSINESS INTERRUPTION. NO CLAIM, SUIT OR ACTION SHALL BE BROUGHT AGAINST TI MORE THAN TWELVE (12) MONTHS AFTER THE EVENT THAT GAVE RISE TO THE CAUSE OF ACTION HAS OCCURRED.

8.2 *Specific Limitations.* IN NO EVENT SHALL TI'S AGGREGATE LIABILITY FROM ANY USE OF AN EVM PROVIDED HEREUNDER, INCLUDING FROM ANY WARRANTY, INDEMNITY OR OTHER OBLIGATION ARISING OUT OF OR IN CONNECTION WITH THESE TERMS, , EXCEED THE TOTAL AMOUNT PAID TO TI BY USER FOR THE PARTICULAR EVM(S) AT ISSUE DURING THE PRIOR TWELVE (12) MONTHS WITH RESPECT TO WHICH LOSSES OR DAMAGES ARE CLAIMED. THE EXISTENCE OF MORE THAN ONE CLAIM SHALL NOT ENLARGE OR EXTEND THIS LIMIT.

9. *Return Policy.* Except as otherwise provided, TI does not offer any refunds, returns, or exchanges. Furthermore, no return of EVM(s) will be accepted if the package has been opened and no return of the EVM(s) will be accepted if they are damaged or otherwise not in a resalable condition. If User feels it has been incorrectly charged for the EVM(s) it ordered or that delivery violates the applicable order, User should contact TI. All refunds will be made in full within thirty (30) working days from the return of the components(s), excluding any postage or packaging costs.

10. *Governing Law:* These terms and conditions shall be governed by and interpreted in accordance with the laws of the State of Texas, without reference to conflict-of-laws principles. User agrees that non-exclusive jurisdiction for any dispute arising out of or relating to these terms and conditions lies within courts located in the State of Texas and consents to venue in Dallas County, Texas. Notwithstanding the foregoing, any judgment may be enforced in any United States or foreign court, and TI may seek injunctive relief in any United States or foreign court.

Mailing Address: Texas Instruments, Post Office Box 655303, Dallas, Texas 75265  
Copyright © 2023, Texas Instruments Incorporated

## IMPORTANT NOTICE AND DISCLAIMER

TI PROVIDES TECHNICAL AND RELIABILITY DATA (INCLUDING DATA SHEETS), DESIGN RESOURCES (INCLUDING REFERENCE DESIGNS), APPLICATION OR OTHER DESIGN ADVICE, WEB TOOLS, SAFETY INFORMATION, AND OTHER RESOURCES "AS IS" AND WITH ALL FAULTS, AND DISCLAIMS ALL WARRANTIES, EXPRESS AND IMPLIED, INCLUDING WITHOUT LIMITATION ANY IMPLIED WARRANTIES OF MERCHANTABILITY, FITNESS FOR A PARTICULAR PURPOSE OR NON-INFRINGEMENT OF THIRD PARTY INTELLECTUAL PROPERTY RIGHTS.

These resources are intended for skilled developers designing with TI products. You are solely responsible for (1) selecting the appropriate TI products for your application, (2) designing, validating and testing your application, and (3) ensuring your application meets applicable standards, and any other safety, security, regulatory or other requirements.

These resources are subject to change without notice. TI grants you permission to use these resources only for development of an application that uses the TI products described in the resource. Other reproduction and display of these resources is prohibited. No license is granted to any other TI intellectual property right or to any third party intellectual property right. TI disclaims responsibility for, and you will fully indemnify TI and its representatives against, any claims, damages, costs, losses, and liabilities arising out of your use of these resources.

TI's products are provided subject to [TI's Terms of Sale](#) or other applicable terms available either on [ti.com](https://www.ti.com) or provided in conjunction with such TI products. TI's provision of these resources does not expand or otherwise alter TI's applicable warranties or warranty disclaimers for TI products.

TI objects to and rejects any additional or different terms you may have proposed.

Mailing Address: Texas Instruments, Post Office Box 655303, Dallas, Texas 75265  
Copyright © 2025, Texas Instruments Incorporated