

# TPSM843A26 4-V to 18-V Input, 16-A, Buck Power Module with Internally Compensated, Advanced Current Mode Control

## 1 Features

- Fixed-frequency, internally compensated advanced current mode (ACM) control
- Integrated 6.5-mΩ and 2-mΩ MOSFETs, Inductor and basic passives
- 4-V to 18-V input voltage range
- 0.5-V to 7-V output voltage range
- True differential remote sense amplifier (RSA)
- Three selectable PWM ramp options to optimize the control loop performance
- Five selectable switching frequencies: 500 kHz, 750 kHz, 1 MHz, 1.5 MHz, and 2.2 MHz
- Synchronizable to an external clock
- 0.5 V, ±0.5% voltage reference accuracy over full temperature range
- 1-ms, 2-ms, 4-ms, and 8-ms selectable soft-start times
- Monotonic start-up into prebiased outputs
- Enable with adjustable input undervoltage lockout
- Power-good output monitor
- Output overvoltage, output undervoltage, input undervoltage, overcurrent, and overtemperature protection
- -40°C to 125°C operating junction temperature
- 6.5-mm × 7.5-mm × 4.0-mm, 25-pin over-molded QFN package
- [Lead-free \(RoHS compliant\)](#)
- Pin compatible with the 20 A - [TPSM843B22](#) and 12 A - [TPSM843A22](#)

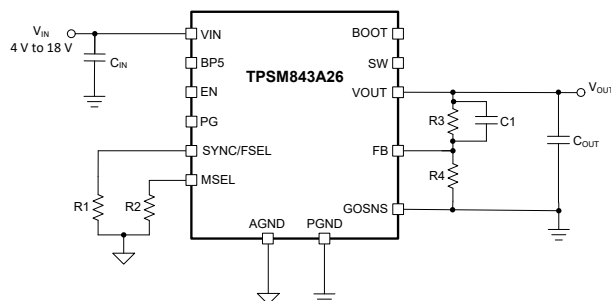

**TPSM843A26 Simplified Application**

## 2 Applications

- [Wireless and wired communications infrastructure equipment](#)
- [Optical and fiber networks](#)
- [Test and measurement](#)
- [Medical and healthcare](#)

## 3 Description

The TPSM843A26 is a high-efficiency 18-V, 16-A synchronous buck module employing an internally compensated, fixed-frequency advanced current mode (ACM) control architecture, which while always operating under FCCM, generates output voltages from 0.5 V to 7 V. The module is capable of providing high efficiency while operating at a switching frequency up to 2.2 MHz. The module is in a 6.5-mm x 7.5-mm x 4-mm over-molded package, which makes it optimal for designs requiring a small solution size. Additional features include a high accuracy voltage reference, selectable soft-start times, monotonic start-up into prebiased outputs, selectable current limits, adjustable UVLO through the EN pin, and a full suite of fault protections.

### Package Information

PART NUMBER	PACKAGE (1)	PACKAGE SIZE(2)
TPSM843A26	RDG (B3QFN-RDG, 25)	6.50 mm × 7.50 mm

- (1) For all available packages, see the orderable addendum at the end of the data sheet.
- (2) The package size (length × width) is a nominal value and includes pins, where applicable.

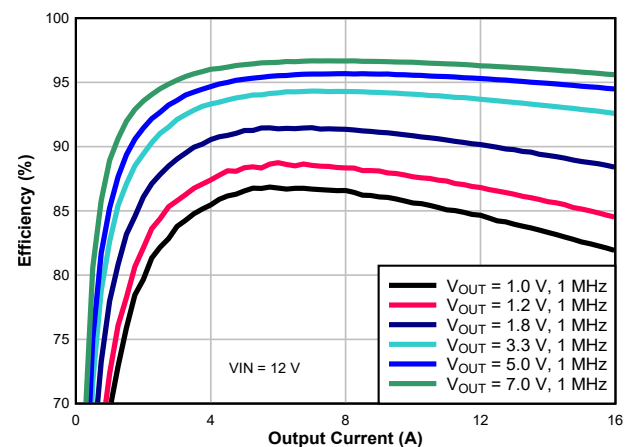

**Typical Application Efficiency**



## Table of Contents

<b>1 Features</b> .....	1	7.3 Feature Description.....	11
<b>2 Applications</b> .....	1	7.4 Device Functional Modes.....	20
<b>3 Description</b> .....	1	<b>8 Application and Implementation</b> .....	21
<b>4 Revision History</b> .....	2	8.1 Application Information.....	21
<b>5 Pin Configuration and Functions</b> .....	3	8.2 Typical Applications.....	21
<b>6 Specifications</b> .....	4	8.3 Power Supply Recommendations.....	30
6.1 Absolute Maximum Ratings.....	4	8.4 Layout.....	30
6.2 ESD Ratings.....	4	<b>9 Device and Documentation Support</b> .....	33
6.3 Recommended Operating Conditions.....	4	9.1 Receiving Notification of Documentation Updates....	33
6.4 Thermal Information.....	5	9.2 Support Resources.....	33
6.5 Electrical Characteristics.....	5	9.3 Trademarks.....	33
6.6 Typical Characteristics.....	7	9.4 Electrostatic Discharge Caution.....	33
<b>7 Detailed Description</b> .....	10	9.5 Glossary.....	33
7.1 Overview.....	10	<b>10 Mechanical, Packaging, and Orderable Information</b> .....	33
7.2 Functional Block Diagram.....	10		

## 4 Revision History

NOTE: Page numbers for previous revisions may differ from page numbers in the current version.

<b>Changes from Revision A (June 2023) to Revision B (July 2023)</b>	<b>Page</b>
• Changed Junction-to-ambient thermal resistance .....	5
• Changed Junction-to-top characterization parameter.....	5
• Changed Junction-to-board characterization parameter.....	5

---

<b>Changes from Revision * (May 2023) to Revision A (June 2023)</b>	<b>Page</b>
• Changed status from Advance Information to Production Data.....	1

## 5 Pin Configuration and Functions

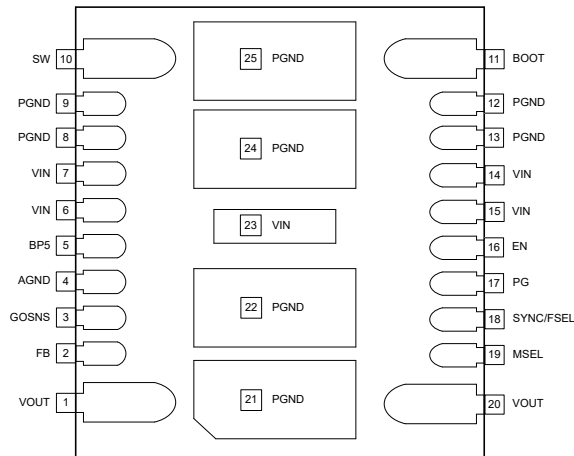

**Figure 5-1. 25-Pin B3QFN-RDG Package (Bottom View)**

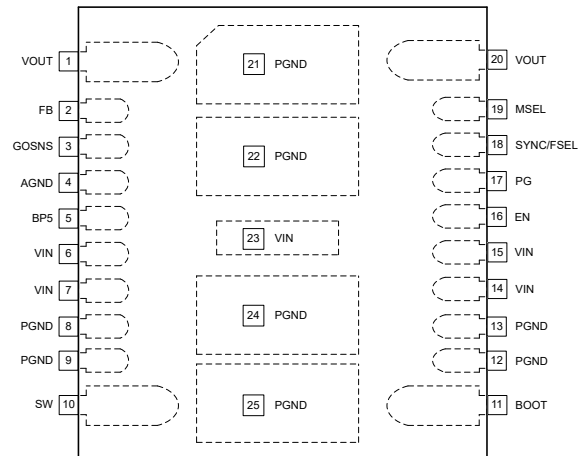

**Figure 5-2. 25-Pin B3QFN-RDG Package (Top View)**

**Table 5-1. Pin Functions**

Pin		Type <sup>(1)</sup>	Description
Name	No.		
VOUT	1,20	O	Output voltage for the converter
FB	2	I	Feedback pin and input to the differential remote sense amplifier for output voltage regulation. Connect this pin to the mid-point of a resistor divider to set the output voltage.
GOSNS	3	I	Ground sense return and input to the differential remote sense amplifier.
AGND	4	G	Analog ground return
BP5	5	—	Bypass pin for the internal analog control circuitry. This pin is bypassed internally. No external bypassing required. A boot capacitor is integrated inside module.
VIN	6,7,14,15,23	P	Input power to the power stage. Low impedance bypassing of these pins to PGND is critical. A 10-nF to 100-nF capacitor from each VIN to PGND as close as possible is recommended.
PGND	8,9,12,13,21,22,24,25	G	Ground return for the power stage. These pins are internally connected to the sources of the low side MOSFETs. 21, 22, 24, 25 act as thermal vias to help dissipate heat from the device to PCB.
SW	10	O	Switch node of the converter. Leave this pin floating.
BOOT	11	I	Supply for the internal high-side MOSFET gate driver. Leave this pin floating.
EN	16	I	Enable pin. Enable the device by floating the enable pin, or tie enable pin to high, or using external signal, or by using UVLO resistors.
PG	17	O	Open drain power-good indicator
SYNC/FSEL	18	I	Frequency select and external clock synchronization. A resistor to ground sets the switching frequency of the device. An external clock can also be applied to this pin to synchronize the switching frequency.
MSEL	19	I	A resistor to ground selects the current limit, soft start rate, and PWM ramp amplitude settings.

(1) I = input, O = output, P = Supply, G = ground

## 6 Specifications

### 6.1 Absolute Maximum Ratings

over operating free-air temperature range (unless otherwise noted) <sup>(1)</sup> <sup>(2)</sup>

		MIN	MAX	UNIT
Pin voltage	VIN	-0.3	20	V
Pin Voltage	VOUT	-0.3	7	V
Pin voltage	SW, DC	-0.3	20	V
Pin voltage	SW, transient 20ns	-5	22	V
Pin voltage	VIN to SW, DC	-0.3	20	V
Pin voltage	VIN to SW, transient 20ns	-6	25	V
Pin voltage	BOOT	-0.3	25	V
Pin voltage	BOOT to SW	-0.3	6	V
Pin voltage	EN, PG, MSEL, SYNC/FSEL, FB	-0.3	6	V
Pin voltage	BP5	-0.3	6	V
Pin voltage	GOSNS	-0.3	0.3	V
Sink current	PG Pin Current Sink Capability			mA
	Peak Reflow Case Temperature		250	°C
	Number of reflows allowed		2	
T <sub>J</sub>	Operating junction temperature	-40	125	°C
T <sub>stg</sub>		-55	150	°C

- (1) Operation outside the Absolute Maximum Ratings may cause permanent device damage. Absolute Maximum Ratings do not imply functional operation of the device at these or any other conditions beyond those listed under Recommended Operating Conditions. If used outside the Recommended Operating Conditions but within the Absolute Maximum Ratings, the device may not be fully functional, and this may affect device reliability, functionality, performance, and shorten the device lifetime.
- (2) All voltage values are with respect to PGND.

### 6.2 ESD Ratings

			VALUE	UNIT
V <sub>(ESD)</sub>	Electrostatic discharge	Human-body model (HBM), per ANSI/ESDA/JEDEC JS-001 <sup>(1)</sup>	±2000	V
V <sub>(ESD)</sub>	Electrostatic discharge	Charged-device model (CDM), per ANSI/ESDA/JEDEC JS-002 <sup>(2)</sup>	±500	V

- (1) JEDEC document JEP155 states that 500-V HBM allows safe manufacturing with a standard ESD control process.
- (2) JEDEC document JEP157 states that 250-V CDM allows safe manufacturing with a standard ESD control process.

### 6.3 Recommended Operating Conditions

Over operating junction temperature range (unless otherwise noted)

			MIN	NOM	MAX	UNIT
V <sub>IN</sub>	Pin voltage	Input voltage range	4		18	V
V <sub>OUT</sub>	Output voltage range		0.5		7	V
	Pin voltage	SW - PGND	-0.1		18	V
	Pin voltage	EN, FB, PG, MSEL, SYNC/FSEL	-0.1		5.5	V
	Pin voltage	GOSNS	-0.3		0.3	V
I <sub>OUT</sub>	Output current range				16	A
I <sub>PG</sub>	Power Good input current			2	5	mA
T <sub>J</sub>	Operating junction temperature		-40		125	°C

## 6.4 Thermal Information

THERMAL METRIC <sup>(1)</sup>		TPSM843B22 TPSM843A26 TPSM843A22	UNIT
		RDG (BGQFN)	
		25 PINS	
R <sub>θJA</sub>	Junction-to-ambient thermal resistance	13.2	°C/W
ψ <sub>JT</sub>	Junction-to-top characterization parameter	0.3	°C/W
ψ <sub>JB</sub>	Junction-to-board characterization parameter	5.5	°C/W

(1) For more information about traditional and new thermal metrics, see the [Semiconductor and IC Package Thermal Metrics](#)

## 6.5 Electrical Characteristics

T<sub>J</sub> = -40°C to +125°C, V<sub>VIN</sub> = 4 V - 18 V (unless otherwise noted)

PARAMETER		TEST CONDITIONS	MIN	TYP	MAX	UNIT
<b>SUPPLY VOLTAGE</b>						
I <sub>Q(VIN)</sub>	VIN operating non-switching supply current	V <sub>EN</sub> = 1.3 V, V <sub>FB</sub> = 550 mV, V <sub>VIN</sub> = 12 V, 1 MHz		1200	1600	μA
I <sub>SD(VIN)</sub>	VIN shutdown supply current	V <sub>EN</sub> = 0 V, V <sub>VIN</sub> = 12 V		20	32	μA
V <sub>INUVLO(R)</sub>	VIN UVLO rising threshold	V <sub>VIN</sub> rising	3.8	4.00	4.2	V
V <sub>INUVLO(H)</sub>	VIN UVLO hysteresis			150		mV
<b>INTERNAL LDO</b>						
BP5	Internal LDO output voltage	V <sub>VIN</sub> = 12 V, I <sub>VBP5</sub> = 25 mA		4.5		V
	Internal LDO dropout voltage	V <sub>VIN</sub> - V <sub>VBP5</sub> , V <sub>VIN</sub> = 3.8 V, I <sub>VBP5</sub> = 25 mA			350	mV
	Internal LDO short-circuit current limit	V <sub>VIN</sub> = 12 V		177		mA
<b>ENABLE</b>						
V <sub>EN(R)</sub>	EN voltage rising threshold	EN rising, enable switching		1.2	1.25	V
V <sub>EN(F)</sub>	EN voltage falling threshold	EN falling, disable switching	1.05	1.1		V
V <sub>EN(H)</sub>	EN voltage hysteresis			100		mV
	EN pin sourcing current	V <sub>EN</sub> = 1.1 V		1.5		μA
	EN pin sourcing current	V <sub>EN</sub> = 1.3 V		11.6		μA
<b>REFERENCE VOLTAGE</b>						
V <sub>FB</sub>	Feedback Voltage	T <sub>J</sub> = -40°C to 125°C	495	500	505	mV
I <sub>FB(LKG)</sub>	Input leakage current into FB pin	V <sub>FB</sub> = 500 mV, non-switching, V <sub>VIN</sub> = 12 V, V <sub>EN</sub> = 0 V		1		nA
<b>REMOTE SENSE AMPLIFIER</b>						
I <sub>LEAK(GOSNS)</sub>	Current out of GOSNS pin		85	90	95	μA
V <sub>IRNG(GOSNS)</sub>	GOSNS common mode voltage for regulation	AGND +/- V <sub>GOSNS</sub>	-100		100	mV
<b>SWITCHING FREQUENCY AND OSCILLATOR</b>						
f <sub>SW</sub>	Switching frequency	R <sub>FSEL</sub> = 24.3 kΩ to AGND	450	500	550	kHz
f <sub>SW</sub>	Switching frequency	R <sub>FSEL</sub> = 17.4 kΩ to AGND	675	750	825	kHz
f <sub>SW</sub>	Switching frequency	R <sub>FSEL</sub> = 11.8 kΩ to AGND	900	1000	1100	kHz
f <sub>SW</sub>	Switching frequency	R <sub>FSEL</sub> = 8.06 kΩ to AGND	1350	1500	1650	kHz
f <sub>SW</sub>	Switching frequency	R <sub>FSEL</sub> = 4.99 kΩ to AGND	1980	2200	2420	kHz
<b>SYNCHRONIZATION</b>						
V <sub>IH(sync)</sub>	High-level input voltage		1.8			V
V <sub>IL(sync)</sub>	Low-level input voltage				0.8	V
<b>SOFT-START</b>						
t <sub>SS1</sub>	Soft-start time	R <sub>MSEL</sub> = 1.78 kΩ		1		ms
t <sub>SS2</sub>	Soft-start time	R <sub>MSEL</sub> = 2.21 kΩ		2		ms
t <sub>SS3</sub>	Soft-start time	R <sub>MSEL</sub> = 2.74 kΩ		4		ms
t <sub>SS4</sub>	Soft-start time	R <sub>MSEL</sub> = 3.32 kΩ		8		ms
<b>POWER STAGE</b>						

## 6.5 Electrical Characteristics (continued)

$T_J = -40^{\circ}\text{C}$  to  $+125^{\circ}\text{C}$ ,  $V_{VIN} = 4\text{ V} - 18\text{ V}$  (unless otherwise noted)

PARAMETER		TEST CONDITIONS	MIN	TYP	MAX	UNIT
$R_{DS(on)HS}$	High-side MOSFET on-resistance	$T_J = 25^{\circ}\text{C}$ , $V_{VIN} = 12\text{ V}$ , $V_{BOOT-SW} = 4.5\text{ V}$		6.5		m $\Omega$
$R_{DS(on)LS}$	Low-side MOSFET on-resistance	$T_J = 25^{\circ}\text{C}$ , $V_{BP5} = 4.5\text{ V}$		2.0		m $\Omega$
$V_{VIN(TH_r)}$	VIN throttle rising threshold	$T_J = 25^{\circ}\text{C}$ . Weaken high-side gate drive upon VIN rising		16		V
$V_{VIN(TH_f)}$	VIN throttle falling threshold	$T_J = 25^{\circ}\text{C}$ . Recover high-side gate drive upon VIN falling		15.5		V
$V_{BOOT-SW(UV_R)}$	BOOT-SW UVLO rising threshold	$V_{BOOT-SW}$ rising		3.2		V
$V_{BOOT-SW(UV_F)}$	BOOT-SW UVLO falling threshold	$V_{BOOT-SW}$ falling		2.8		V
$T_{ON(min)}$	Minimum ON pulse width			22	37	ns
$T_{OFF(min)}$	Minimum OFF pulse width <sup>(1)</sup>			115		ns
<b>CURRENT SENSE AND OVERCURRENT PROTECTION</b>						
$I_{HS(OC1)}$	High-side peak current limit (A26)	$R_{MSEL} = 2.1\text{ k}\Omega$	20.7	23	25.3	A
$I_{HS(OC1)}$	High-side peak current limit (A26)	$R_{MSEL} = 22.1\text{ k}\Omega$	16.2	18	19.8	A
$I_{LS(OC1)}$	Low-side valley current limit (A26)	$R_{MSEL} = 2.1\text{ k}\Omega$	16.74	18.6	20.46	A
$I_{LS(OC1)}$	Low-side valley current limit (A26)	$R_{MSEL} = 22.1\text{ k}\Omega$	12.51	13.9	15.29	A
$I_{LS(NOC)}$	Low-side negative current limit	Current into SW pin	7			A
<b>OUTPUT OVERVOLTAGE AND UNDERVOLTAGE PROTECTIONS</b>						
$V_{OVP}$	Overvoltage-protection (OVP) threshold voltage	$V_{FB}$ rising		120		% $V_{REF}$
$V_{UVP}$	Undervoltage-protection (UVP) threshold voltage	$V_{FB}$ falling		80		% $V_{REF}$
<b>PG (Power Good)</b>						
	PG threshold	$V_{FB}$ rising (Good)	88	92	94	% $V_{REF}$
	PG threshold	$V_{FB}$ rising (OV Fault)	112	116	118	% $V_{REF}$
	PG threshold	$V_{FB}$ falling (Good)	103.5	108	109.5	% $V_{REF}$
	PG threshold	$V_{FB}$ falling (UV Fault)	79	84	85	% $V_{REF}$
$I_{PG(LKG)}$	Leakage current into PG pin when open drain output is high	$V_{PG} = 4.7\text{ V}$			5	$\mu\text{A}$
$V_{PG(low)}$	PG low-level output voltage	$I_{PG} = 2\text{ mA}$ , $V_{IN} = 12\text{ V}$			0.5	V
	Min VIN for valid PG output			1		V
	PG delay going from low to high			256		$\mu\text{s}$
	PG delay going from high to low			8		$\mu\text{s}$
<b>HICCUP</b>						
	Hiccup time before re-start			$7 \cdot t_{SS}$		ms
<b>OUTPUT DISCHARGE</b>						
$R_{Dischg}$	Output discharge resistance	$V_{VIN} = 12\text{ V}$ , $V_{SW} = 0.5\text{ V}$ , power conversion disabled.		100		$\Omega$
<b>THERMAL SHUTDOWN</b>						
$T_{J(SD)}$	Thermal shutdown threshold <sup>(1)</sup>	Temperature rising		165		$^{\circ}\text{C}$
$T_{J(HYS)}$	Thermal shutdown hysteresis <sup>(1)</sup>			30		$^{\circ}\text{C}$

(1) Specified by design

## 6.6 Typical Characteristics

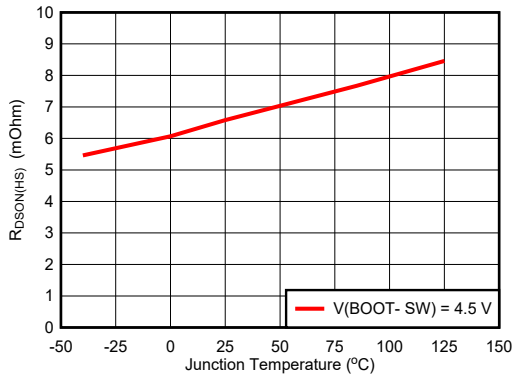

Figure 6-1. High-Side FET  $R_{dsON}$

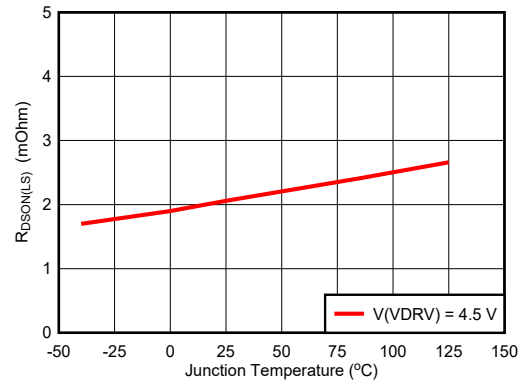

Figure 6-2. Low-Side FET  $R_{dsON}$

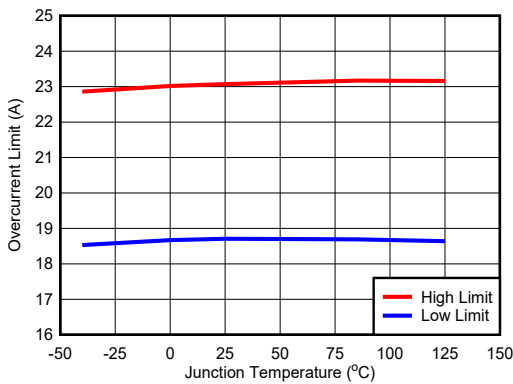

Figure 6-3. Overcurrent Limit

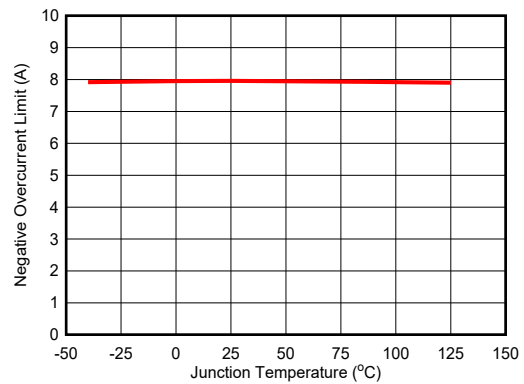

Figure 6-4. Negative Overcurrent Limit

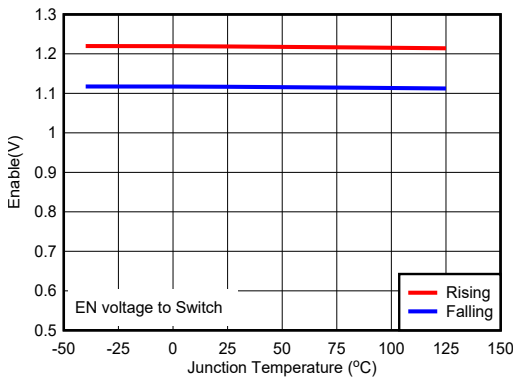

Figure 6-5. Enable Voltage

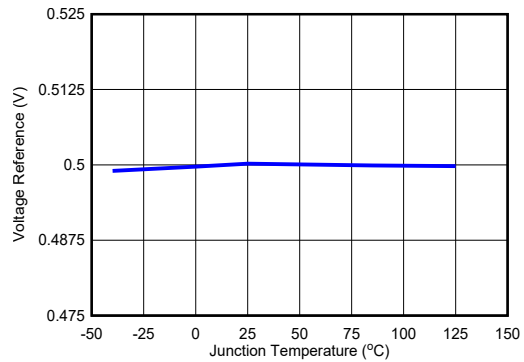

Figure 6-6.  $V_{REF}$

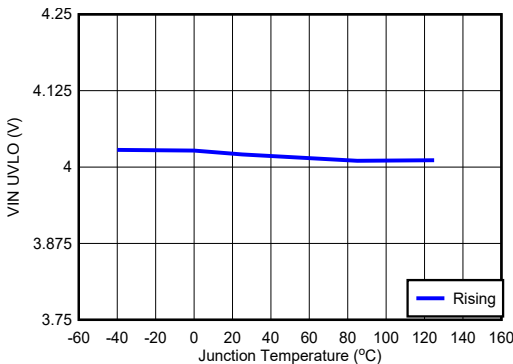

Figure 6-7.  $V_{IN}$  UVLO

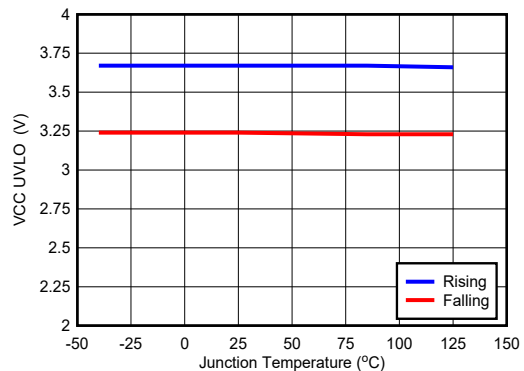

Figure 6-8.  $V_{CC}$  UVLO

## 6.6 Typical Characteristics (continued)

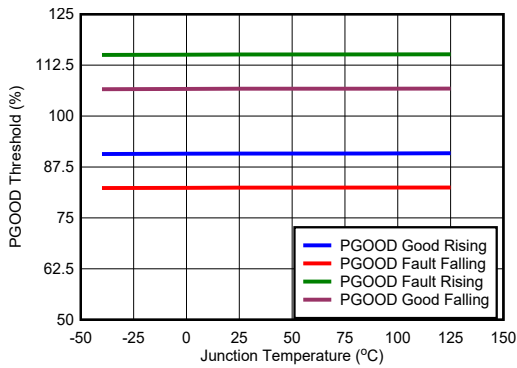

Figure 6-9. PG Threshold

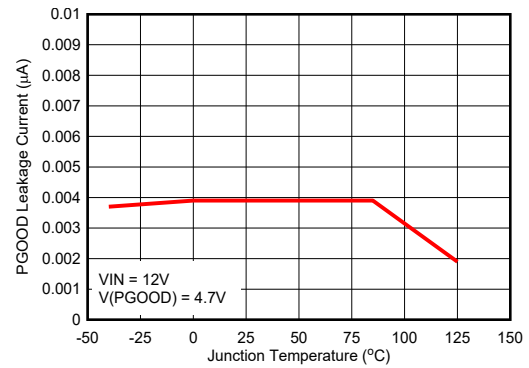

Figure 6-10. PG Leakage Current

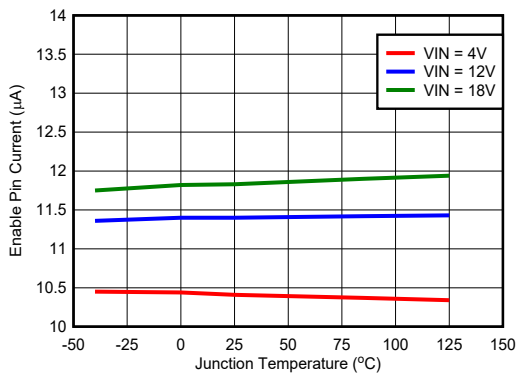

Figure 6-11. Enable Pin Current at Different VIN

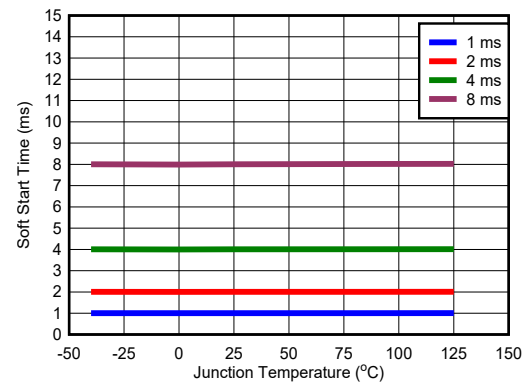

Figure 6-12. Soft Start

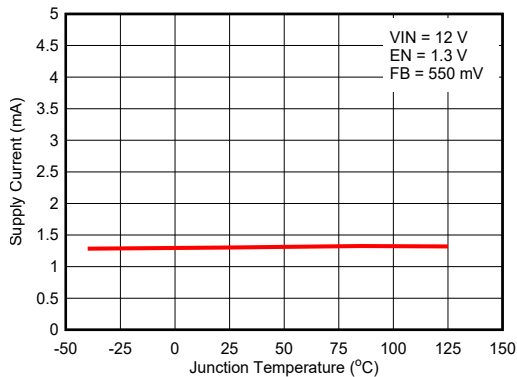

Figure 6-13. Non-Switching Supply Current

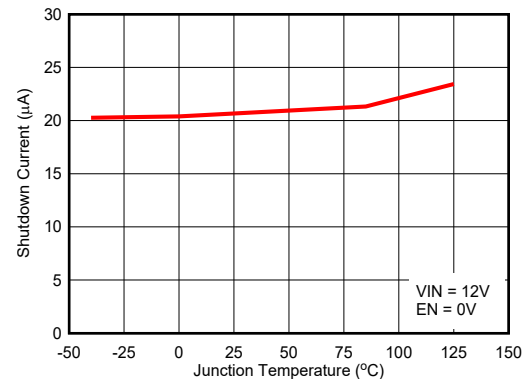
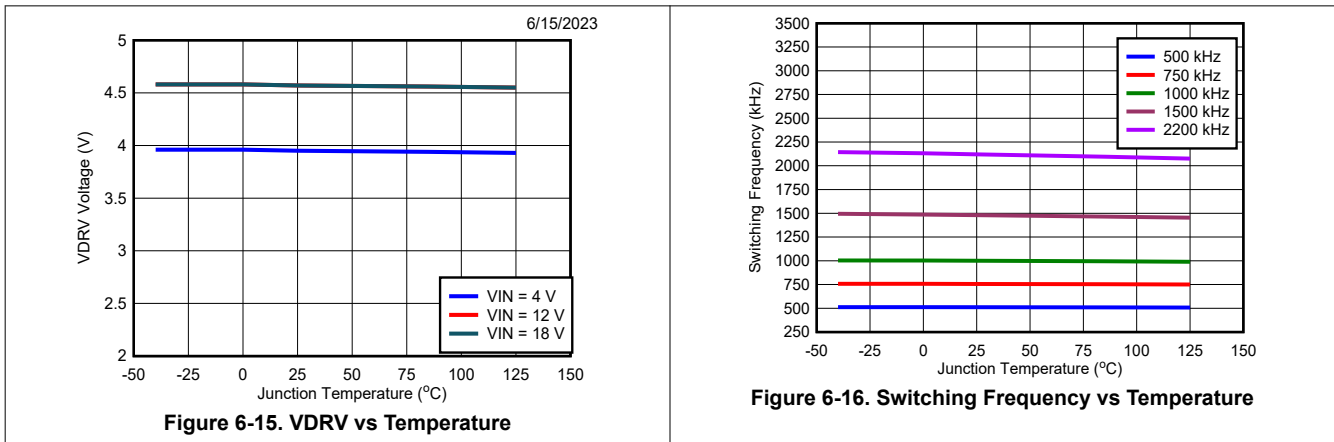

Figure 6-14. Shutdown Supply Current



## 6.6 Typical Characteristics (continued)



## 7 Detailed Description

### 7.1 Overview

The TPSM843A26 is a 16-A, high-performance, synchronous buck module with two integrated N-channel MOSFETs, inductor, and several passives. The TPSM843A26 has a maximum operating junction temperature of 125°C, making it designed for high-ambient temperature applications such as wireless infrastructure, wired optical modules and test and measurement applications. The input voltage range is 4 V to 18 V and the output voltage range is 0.5 V to 7 V. The module features a fixed-frequency advanced current mode (ACM) control architecture with five switching frequency selection settings ranging from 500 kHz to 2.2 MHz, allowing for efficiency and size optimization when selecting output filter components. The switching frequency of the device can be synchronized to an external clock applied to the FSEL/SYNC pin.

Advanced current mode is an emulated peak current-mode control topology, supporting stable static and transient operation without the requirement for a complex external compensation design. ACM includes an internal ramp generation network that emulates inductor current information, enabling the use of low-ESR output capacitors such as multi-layered ceramic capacitors (MLCC). The internal ramp also creates a high signal-to-noise ratio for good noise immunity. The TPSM843A26 has three ramp options to optimize the internal feedback loop for various inductor and output capacitor combinations with only a single resistor to AGND (see [Section 7.3.7.2](#) for details). The TPSM843A26 is easy to use and allows low external component count with fast load transient response. Fixed-frequency modulation also provides ease-of-filter design to overcome EMI noise.

### 7.2 Functional Block Diagram

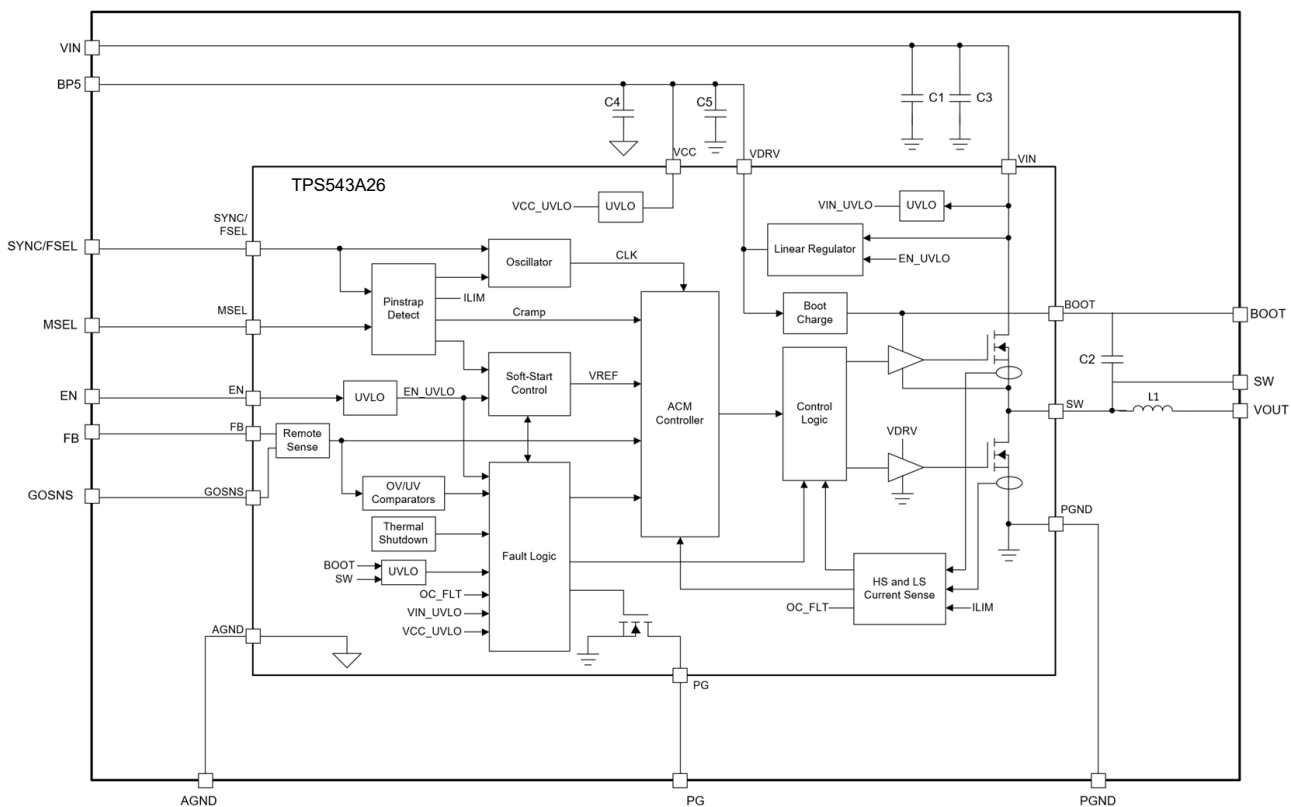

## 7.3 Feature Description

### 7.3.1 VIN Pins and VIN UVLO

The VIN pin voltage supplies the internal control circuits of the device and provides the input voltage to the power stage. The input voltage for  $V_{IN}$  can range from 4 V to 18 V. The device implements internal UVLO circuitry on the VIN pin. The device is disabled when the VIN pin voltage falls below the internal  $V_{IN}$  UVLO threshold. The internal  $V_{IN}$  UVLO threshold for start-up is 3.95 V typically with hysteresis of 150 mV.

A second means to enable the device is provided by interfacing to the EN pin. See [Section 7.3.3](#) for more details.

### 7.3.2 Internal Bypassing (BP5)

The BP5 pin is the bypass pin for internal analog circuitry. This pin is connected internally to the VCC and VDRV pins of the converter with internal bypass capacitors of 0.1  $\mu\text{F}$  to VCC and 2.2  $\mu\text{F}$  to VDRV pins of the internal converter. This pin is bypassed internally and no external bypassing is required.

### 7.3.3 Enable and Adjustable UVLO

The EN pin provides means for on and off control of the device. After the EN pin voltage exceeds its threshold voltage, the device begins a start-up sequence. If the EN pin voltage is pulled below the threshold voltage, the regulator stops switching and enters a low operating current state. The EN pin has an internal pullup current source,  $I_p$ , allowing the pin to be floated to enable the device by default. Ensure that leakage current of any circuitry connected to the EN pin does not exceed the minimum EN pullup current, otherwise the device can not be able to start. If an application requires digital control of the ENABLE function, an open-drain or open-collector output logic can be interfaced with the pin.

Alternatively, an external resistor divider can be added from VIN to the EN pin for adjustable UVLO as shown in [Figure 7-1](#). The EN pin pullup hysteresis current,  $I_h$ , is used to control the voltage hysteresis for the UVLO function by increasing the pin sourcing current after the EN pin crosses the enable threshold. The UVLO thresholds can be calculated using [Equation 1](#) and [Equation 2](#). When using the adjustable UVLO function, 500 mV or greater hysteresis is recommended. For applications with very slow input voltage slew rate, a capacitor can be placed from the EN pin to ground to filter any noise on the input voltage.

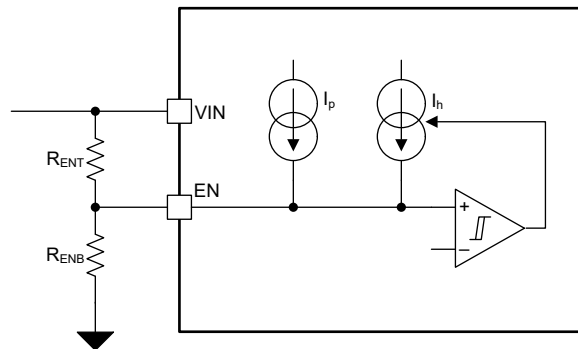

**Figure 7-1. Adjustable UVLO Using EN**

$$R_{ENT} = \frac{V_{START} \times \left( \frac{V_{ENFALLING}}{V_{ENRISING}} \right) - V_{STOP}}{I_p \times \left( 1 - \frac{V_{ENFALLING}}{V_{ENRISING}} \right) + I_h} \quad (1)$$

$$R_{ENB} = \frac{R_{ENT} \times V_{ENFALLING}}{V_{STOP} - V_{ENFALLING} + R_{ENT} \times (I_p + I_h)} \quad (2)$$

### 7.3.3.1 Internal Sequence of Events During Start-up

The enable feature of the TPSM843A26 provides two-threshold-level functionality. When the EN pin voltage is less than the internal start-up threshold (approximately 0.8 V), the device is in a low-power shutdown mode. When the EN pin voltage rises to above this threshold, the internal linear regulator (LDO) is enabled and charges the external VDRV capacitor. When VCC is connected to VDRV, and the voltage on the VCC pin exceeds its UVLO threshold (approximately 3.6 V), the TPSM843A26 reads the pin strap configuration as determined by the MSEL pin (see [Section 7.3.9](#)) and SYNC/FSEL pin (see [Section 7.3.5.3](#)) settings, and then enters a standby state.

The second EN pin threshold becomes active when both the VIN UVLO (approximately 4 V) and VCC UVLO thresholds are exceeded. Thus, when the EN pin reaches above the (nominally 1.2 V) upper threshold, the TPSM843A26 initiates a power-on delay (typically 64  $\mu$ s) to initialize the control loop circuitry. After the power-on delay, the power stage is enabled and soft start begins.

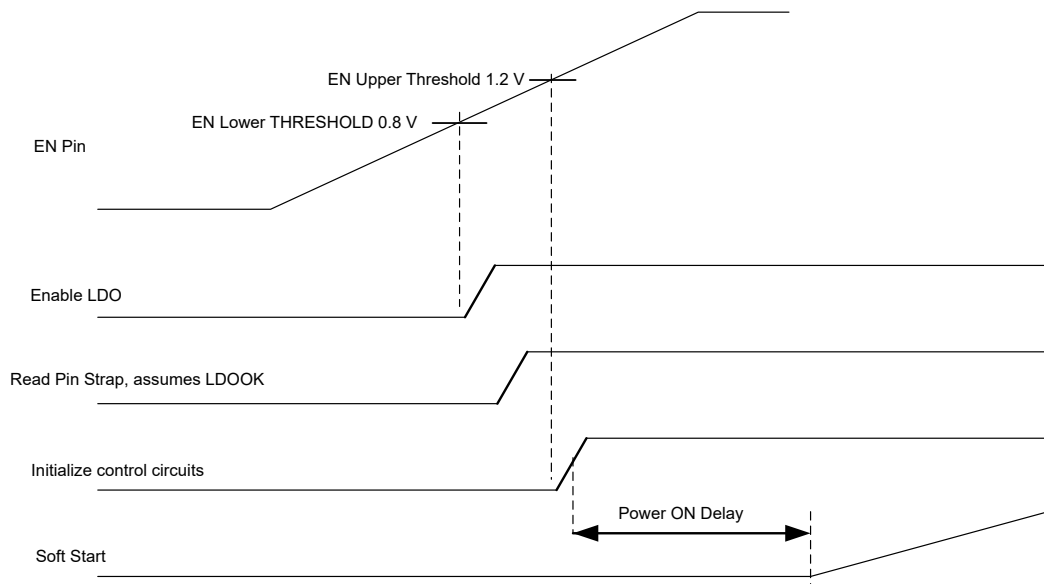

**Figure 7-2. Internal Start-up Sequence**

If the enable signal rises very quickly, the delay time from EN rising to the beginning of soft start is a function of the time required to power and initialize the device (start-up of the linear regulator, VCC UVLO exceeded, reading pin strap level, initialize feedback circuitry, and so forth), and can take up to 1 ms (typical).

### 7.3.4 Switching Frequency Selection

The switching frequency of the device is selected by connecting a resistor ( $R_{FSEL}$ ) from the SYNC/FSEL pin to AGND. The frequency options and their corresponding programming resistors are listed in [Table 7-1](#). Use a 1% tolerance resistor or better.

**Table 7-1. Switching Frequency Selection**

$R_{FSEL}$ Allowed Nominal Range (1%) (k $\Omega$ )	Recommended E96 Standard Value (1%) (k $\Omega$ )	Recommended E12 Standard Value (1%) (k $\Omega$ )	$f_{sw}$ (kHz)
$\geq 24.0$	24.3	27.0	500
17.4 – 18.0	17.4	17.8	750
11.8 – 12.1	11.8	12.1	1000
8.06 – 8.25	8.06	8.25	1500
$\leq 5.11$	4.99	4.75	2200

### 7.3.5 Switching Frequency Synchronization to an External Clock

The TPSM843A26 can be synchronized to an external clock by applying a square wave clock signal to the SYNC/FSEL pin with a duty cycle from 20% to 80%. The external clock can either be applied before the device starts up or during operation. If the external clock is applied before the device starts, a resistor from SYNC/FSEL to AGND is not needed. If the external clock is applied after the device starts, then the clock frequency must be within  $\pm 20\%$  of the frequency set by the SYNC/FSEL resistor. When the external clock is applied after the device starts, the device begins synchronizing to this external clock after counting four consecutive switching cycles with the external clock pulse present. See [Section 7.3.5.2](#).

Although there is no internal circuit to detect the higher 20% range of the clock frequency, it falls outside the stability range of the LC design so it is imposed as a requirement on the customer to ensure the synchronization clock is within  $\pm 20\%$  of the frequency set by the SYNC/FSEL resistor.

#### 7.3.5.1 Internal PWM Oscillator Frequency

When the external clock is present, the device synchronizes the switching frequency to the clock. Any time the external clock is not present, the device defaults to the internal PWM oscillator frequency.

If the device starts up before an external clock signal is applied, then the internal PWM oscillator frequency is set by the  $R_{FSEL}$  resistor according to [Section 7.3.5.3](#). The device switches at this frequency until the external clock is applied or anytime the external clock is not present.

If the external clock is applied before the device starts up, then the  $R_{FSEL}$  resistor is not needed. The device then decodes the external clock frequency and selects an internal PWM oscillator frequency.

**Table 7-2. Internal Oscillator Frequency Decode**

External Sync Clock Frequency (kHz)	Decoded Internal PWM Oscillator Frequency (kHz)
400 – 600	500
600 – 857	750
857 – 1200	1000
1200 – 1810	1500
1810 – 2640	2200

The thresholds for the external SYNC clock frequency ranges have approximately a  $\pm 5\%$  tolerance. If the external clock frequency is within that tolerance range, it is possible for the internal PWM oscillator frequency to be decoded as either the frequency above or below that threshold. Because the internal frequency is what is used in case of the loss of the synchronization clock, TI recommends that the output LC filter and ramp selection are chosen for stability for either frequency. [Table 7-3](#) shows the tolerance range of the decode thresholds. If the external clock is to be within any of these ranges, TI recommends to design the converter to ensure converter stability for both possible internal PWM oscillator frequencies.

**Table 7-3. Frequency Decode Thresholds**

Minimum (kHz)	Typical (kHz)	Maximum (kHz)
570	600	630
814	857	900
1140	1200	1260
1736	1810	1884

#### 7.3.5.2 Loss of Synchronization

If at any time during operation, there is a loss of synchronization, the device defaults to the internal PWM oscillator frequency until the synchronization clock returns. After the clock is no longer present, the device switches at 70% of the internal clock frequency for four consecutive cycles. After four consecutive cycles without clock pulses, the device operates at the normal internal PWM oscillator frequency.

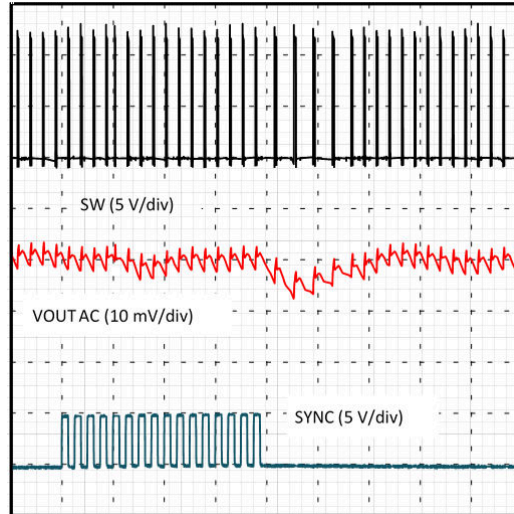

**Figure 7-3. Clock Synchronization Transition**

### 7.3.5.3 Interfacing the SYNC/FSEL Pin

If an application requires synchronizing to a SYNC clock but the clock is unavailable before the device is enabled, TI recommends a high impedance buffer to ensure proper detection of the  $R_{FSEL}$  value. [Figure 7-4](#) shows the recommended implementation. The leakage current into the buffer output must be less than  $5\ \mu\text{A}$  to ensure proper detection of the  $R_{FSEL}$  value. Power the buffer from the BP5 output of the device to ensure its VCC voltage is available and the buffer output is high impedance before the device tries to detect the  $R_{FSEL}$  value. When powering the buffer from the BP5 pin, the external load on the BP5 pin must be less than 2 mA.

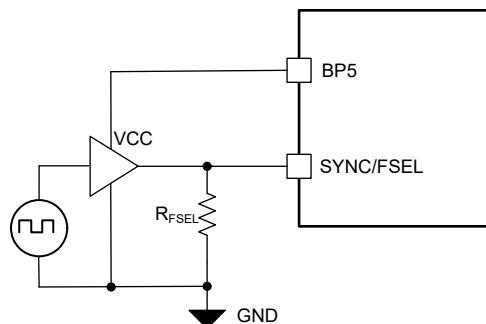
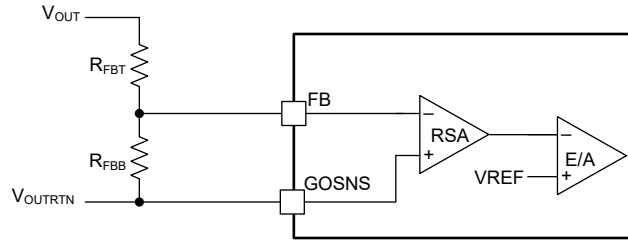

**Figure 7-4. Interfacing the SYNC/FSEL Pin with a Buffer**

### 7.3.6 Remote Sense Amplifier and Adjusting the Output Voltage

Remote sensing of the output voltage is provided through a dedicated high speed, low offset instrumentation type amplifier. Connect the output voltage setting resistive divider described below from the output voltage sensing point to the GOSNS pin. The center point is to be connected to the FB pin. Note the GOSNS pin is to be tied to the converter output voltage return at a location near to the load.

The output voltage is programmed with a resistor divider from the converter output ( $V_{OUT}$ ) to the FB pin as shown in [Figure 7-5](#). Use 1% tolerance or better divider resistors.



**Figure 7-5. FB Resistor Divider**

Starting with a fixed value for the bottom resistor, typically 10 k $\Omega$ , use [Equation 3](#) to calculate the top resistor in the divider.

$$R_{FBT} = R_{FBB} \times \left( \frac{V_{OUT}}{V_{REF}} - 1 \right) \quad (3)$$

### 7.3.7 Loop Compensation Guidelines

The TPSM843A26 employs advanced current mode control (ACM) architecture to provide internal feedback loop compensation for most applications. By applying  $V_{IN}$ , duty cycle, and low-side FET current information to generate an internal ramp combined with contribution from internally sensed inductor valley current, ACM cancels one of the poles of the output LC filter and provides phase compensation to ensure loop stability. As with any internal compensation scheme, certain design guidelines must be followed. Guidelines for a converter design are provided in the following sections.

#### 7.3.7.1 Output Filter Inductor Tradeoffs

The selection of the output inductor is one of the most important choices to make in designing the module. The following is a short list of considerations which were done when determining the value of the inductor used in this module.

Start with an inductor value that results in a ripple current ( $\Delta I$ ) between 30% and 50% of full load.

$$L = \frac{(V_{IN} - V_{OUT})}{\Delta I} \times \frac{V_{OUT}}{V_{IN}} \times \frac{1}{f_{SW}} \quad (4)$$

- A choice of inductor value has a direct correlation to load transient response. Too large an inductor value can result in poor load transient response.
- The ripple current has an impact on the DC load current at which the converter enters current limit. Ensure that the peak valley current at full load is less than the current limit threshold by an adequate margin. A recommended range is 60% to 80% of the current limit threshold.
- The ripple current has an impact on the RMS losses of the converter. The higher the ripple current, the higher the RMS losses.

#### 7.3.7.2 Ramp Capacitor Selection

The TPSM843A26 uses input voltage, duty cycle, and low-side FET current information to generate an internal ramp. The ramp amplitude is determined by an internal ramp generation capacitor,  $C_{RAMP}$ . Three different values for  $C_{RAMP}$  can be selected with a resistor to AGND on the MSEL pin (see [Section 7.3.9](#)). The capacitor options are 1 pF, 2 pF, and 4 pF. A larger ramp capacitor results in a smaller ramp amplitude, which results in a higher control loop bandwidth. The following figures show how the loop changes with each ramp setting for the schematic in [Figure 8-1](#).

Many applications perform best with a  $C_{RAMP}$  value of 4 pF, however, the user must measure the loop gain and phase to determine the optimum  $C_{RAMP}$  value for their specific application.

1. First, calculate the RAMP time constant using [Equation 5](#) and [Table 7-4](#).

$$\tau_{CRAMP} = \frac{C_{RAMP} \times 10^6}{\text{Lookup1} - \text{Lookup2} \times \frac{V_{OUT}}{V_{IN}}} \tag{5}$$

**Table 7-4. RAMP Selection Lookup Values**

f <sub>sw</sub> (kHz)	Lookup1 Value	Lookup2 Value
500	0.372	0.297
750	0.548	0.445
1000	0.719	0.594
1500	1.04	0.891
2200	1.46	1.31

- Next, calculate the RAMP capacitor voltage to ensure the capacitor chosen for C<sub>RAMP</sub> does not result in a ramp amplitude of greater than 1.25 V, which ensures the ramp does not saturate to ground during a load transient.

$$V_{CRAMP} = \frac{V_{IN} \times (t_{ON} + 100 \text{ ns})}{\tau_{CRAMP}} \tag{6}$$

- A larger C<sub>RAMP</sub> capacitance results in highest loop gain.
- A smaller C<sub>RAMP</sub> capacitance requires fewer output capacitors, and results in a higher crossover frequency.

Figure 7-6 and Figure 7-7 show how the loop changes with each ramp setting for the schematic in Section 8.

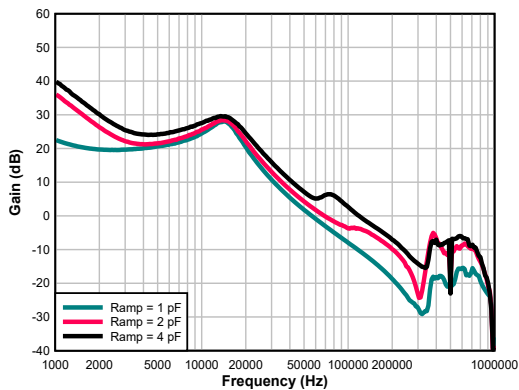

**Figure 7-6. Loop Gain vs Ramp Settings**

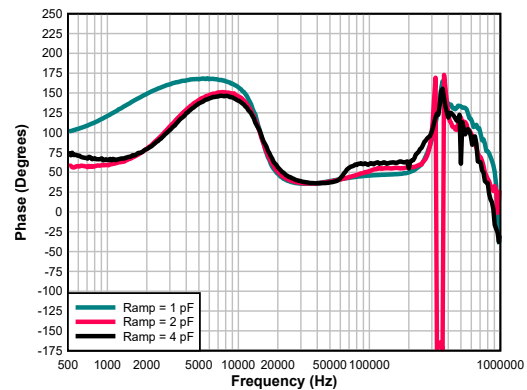

**Figure 7-7. Loop Phase vs Ramp Settings**

### 7.3.7.3 Output Capacitor Selection

- Ensure the ESR zero frequency of the capacitors used is at least 5 × the expected crossover frequency. This way, the impact of the ESR on the loop gain is reduced to a manageable level.

$$f_{ESR\_ZERO} = \frac{1}{2\pi \times R_{ESR} \times C} \tag{7}$$

- The amount of output capacitance has a direct impact on the closed loop bandwidth of the converter. Too little capacitance and the bandwidth can be too high to maintain stability.
- The amount of output capacitance has a direct impact on output voltage overshoot during a load drop. Too little capacitance and the stored energy in the output inductor can cause the output voltage to overshoot during a sharp load decrease.
- The impedance of the output capacitance (impedance of the capacitors plus ESR) has an impact on the output ripple noise of the converter. Too high an impedance (due to not enough capacitance, too high ESR, or both) can result in output ripple above system requirements.



$$V_{\text{RIPPLE}} = \Delta I \times \left( R_{\text{ESR}} + \frac{1}{2\pi \times f_{\text{SW}} \times C} \right) \quad (8)$$

### 7.3.7.4 Design Method for Good Transient Response

The following method to design converter compensation optimizes the load transient response.

1. Calculate the required output impedance to meet transient response goals. This equation assumes the load step transient is faster than the BW of the converter.

$$Z_{\text{OUT\_REQUIRED}} = \frac{\Delta V_{\text{OUT}}}{\Delta I_{\text{OUT}}} \quad (9)$$

2. Select a value for output inductance.

$$L = \frac{(V_{\text{IN}} - V_{\text{OUT}})}{\Delta I} \times \frac{V_{\text{OUT}}}{V_{\text{IN}}} \times \frac{1}{f_{\text{SW}}} \quad (10)$$

3. Calculate the required converter output impedance to meet the transient response goal.

$$Z_{\text{OUT\_CONVERTER}} = \frac{\left( 0.00135 + \frac{L}{\tau_{\text{CRAMP}}} \right)}{34} \times \frac{V_{\text{OUT}}}{V_{\text{REF}}} \quad (11)$$

Ensure  $Z_{\text{OUT\_CONVERTER}}$  is less than the  $Z_{\text{OUT\_REQUIRED}}$  found in step 1. Also recheck the voltage on  $C_{\text{RAMP}}$  is within acceptable limits. (see previous section) If it is too large, use a larger  $C_{\text{RAMP}}$  value.

4. Calculate the minimum output capacitance required to meet the impedance requirements.

$$C_{\text{OUT\_MIN}} = \frac{1}{2\pi \times Z_{\text{OUT\_CONVERTER}} \times f_{\text{CO\_DESIRED}}} \quad (12)$$

where

- $f_{\text{CO\_DESIRED}}$  is the desired converter closed loop crossover frequency, which is usually 1/8 to 1/4 of the converter switching frequency.
5. Calculate the number of output capacitors required. From the previous section, use the guidelines for ESR to select a capacitor type and value, then use the equation here to find the number of capacitors required. Notice that the *impedance* of the capacitors (ESR plus impedance of the capacitance itself at the chosen crossover frequency) is used.

$$Z_{\text{CAPACITOR}} = R_{\text{ESR\_CAPACITOR}} + \frac{1}{2\pi \times C_{\text{CAPACITOR}} \times F_{\text{CO}}} \quad (13)$$

$$N_{\text{CAPACITORS}} = \frac{Z_{\text{CAPACITOR}}}{Z_{\text{OUT\_CONVERTER}}} \quad (14)$$

6. Using one of the tools on TI.com, simulate with the values for the design.

### 7.3.8 Soft Start and Prebiased Output Start-up

During start-up, the device softly increases the reference voltage from zero to its final value, thereby reducing converter inrush current. There are four options for the soft-start time, which is the time it takes for the reference to ramp to 0.5 V:

- 1 ms
- 2 ms
- 4 ms
- 8 ms

The soft-start time is selected with a resistor to AGND on the MSEL pin. See [Section 7.3.9](#).

If a prebiased output condition exists prior to start-up, the device prevents current from being discharged from the output. During monotonic prebiased start-up, the low-side MOSFET is not allowed to sink current until the SS pin voltage is higher than the FB pin voltage and the high-side MOSFET begins to switch. The one exception is if the BOOT-SW voltage is below its UVLO threshold. While in BOOT-SW UVLO, the low-side MOSFET is allowed

to turn on to charge the BOOT capacitor. The low-side MOSFET reverse current protection provides another layer of protection for the device after the high-side MOSFET begins to switch.

### 7.3.9 MSEL Pin

The ramp amplitude, soft-start time, and current limit settings are programmed with a single resistor,  $R_{MSEL}$ , from MSEL to AGND. Table 7-5 lists the resistor values for the available options. Use a 1% tolerance resistor or better. See Section 7.3.11.1 for the corresponding current limit thresholds for the "High" and "Low" settings.

**Table 7-5. MSEL Pin Selection**

$R_{MSEL}$ (k $\Omega$ )	Current Limits	$C_{RAMP}$ (pF)	Soft-Start Time (ms)
1.78	High	1	1
2.21	High	1	2
2.74	High	1	4
3.32	High	1	8
4.02	High	2	1
4.87	High	2	2
5.9	High	2	4
7.32	High	2	8
9.09	High	4	1
11.3	High	4	2
14.3	High	4	4
18.2	High	4	8
22.1	Low	1	1
26.7	Low	1	2
33.2	Low	1	4
40.2	Low	1	8
49.9	Low	2	1
60.4	Low	2	2
76.8	Low	2	4
102	Low	2	8
137	Low	4	1
174	Low	4	2
243	Low	4	4
412	Low	4	8

### 7.3.10 Power Good (PG)

The TPSM843A26 PG pin is an open-drain output requiring an external pullup resistor to output a high signal. After the FB pin is between 92% and 108% of the internal voltage reference, soft start is complete, and after a 256- $\mu$ s deglitch time, the PG pin is de-asserted and the pin floats. TI recommends a pullup resistor between the values of 10 k $\Omega$  and 100 k $\Omega$  to a voltage source that is 5.5 V or less. PG is in a defined state after the VIN input voltage is greater than 1 V but with reduced current sinking capability. When the FB is lower than 84% or greater than 116% of the nominal internal reference voltage, after a 8- $\mu$ s deglitch time, the PG pin is pulled low. PG is immediately pulled low if VIN falls below its UVLO, the EN pin is pulled low or the device enters thermal shutdown.

### 7.3.11 Output Overload Protection

The TPSM843A26 protects against output overload (that is, overcurrent) events by cycle-by-cycle current limiting both the high-side MOSFET and low-side MOSFET. In an extended overcurrent condition, the device enters hiccup mode. Different protections are active during positive inductor current and negative inductor current conditions.

### 7.3.11.1 Positive Inductor Current Protection

Current is sensed in the high-side MOSFET while it is conducting after a short blanking time to allow noise to settle. Whenever the high-side overcurrent threshold is exceeded, the high-side MOSFET is immediately turned off and the low-side MOSFET is turned on. The high-side MOSFET does not turn back on until the current falls below the low-side MOSFET overcurrent threshold, effectively limiting the peak current in the case of a short-circuit condition. If a high-side overcurrent is detected for 15 consecutive cycles, the device enters hiccup mode.

The current is also sensed in the low-side MOSFET while it is conducting after a short blanking time to allow noise to settle. If the low-side overcurrent threshold is exceeded when the next incoming PWM signal is received from the controller, the device skips processing that PWM pulse. The device does not turn the high-side MOSFET on again until the low-side overcurrent threshold is no longer exceeded. If the low-side overcurrent threshold remains exceeded for 15 consecutive cycles, the device enters hiccup. There are two separate counters for the high-side and low-side overcurrent events. If the off time is too short, the low-side overcurrent can not trip. The low-side overcurrent, however, begins tripping after the high-side peak overcurrent limit is crossed, as exceeding the peak current limit shortens the on time and lengthens the off time.

Both the high-side and low-side positive overcurrent thresholds are programmable using the MSEL pin. Two sets of thresholds are available ("High" and "Low"), which are summarized in [Table 7-6](#). The values for these thresholds are obtained using open-loop measurements with a DC current to accurately specify the values. In real applications, the inductor current ramps and the ramp rate is a function of the voltage across the inductor ( $V_{IN} - V_{OUT}$ ) as well as the inductance value. The ramp rate combined with delays in the current sense circuitry then results in slightly different values than specified. The current at which the high-side overcurrent limit takes effect can be slightly higher than specified, and the current at which the low-side overcurrent limit takes effect can be slightly lower than specified.

**Table 7-6. Overcurrent Thresholds**

MSEL Current Limit Setting	High-Side Overcurrent Typical Value (A)	Low-Side Overcurrent Typical Value (A)
High	23	17.6
Low	17.5	13.2

### 7.3.11.2 Negative Inductor Current Protection

Negative current is sensed in the low-side MOSFET while it is conducting after a short blanking time to allow noise to settle. Whenever the low-side negative overcurrent threshold is exceeded, the low-side MOSFET is immediately turned off. The next high-side MOSFET turn-on is determined by the clock and PWM comparator. The negative overcurrent threshold minimum value is 7 A. Similar to the positive inductor current protections, the actual value of the inductor current when the current sense comparators trip is a function of the current ramp rate. As a result, the current at which the negative inductor current limit takes effect can be slightly more negative than specified.

### 7.3.12 Output Overvoltage and Undervoltage Protection

The TPSM843A26 incorporates both output overvoltage and undervoltage protection. If an overvoltage is detected, the device tries to discharge the output voltage to a safe level before attempting to restart. When the overvoltage threshold is exceeded, the low-side MOSFET is turned on until the low-side negative overcurrent threshold is reached. At this point, the high-side MOSFET is turned on until the inductor current reaches zero. Then, the low-side MOSFET is turned back on until the low-side negative overcurrent threshold is reached. The process repeats until the output voltage falls back into the PG window. After this happens, the device restarts and goes through a soft start cycle. The device does not wait the hiccup time before restarting.

When an undervoltage condition is detected, the device enters hiccup where it waits seven soft-start cycles before restarting. Undervoltage protection is enabled after soft start is complete.

### 7.3.13 Overtemperature Protection

When the die temperature exceeds 165°C, the device turns off. After the die temperature cools below the hysteresis level, typically by 12°C, the device restarts. While waiting for the temperature to fall below the hysteresis level, the device does not switch or attempt to hiccup to restart. After the temperature falls below the hysteresis level, the device restarts without going through hiccup.

### 7.3.14 Output Voltage Discharge

When the TPSM843A26 is enabled, but the high-side FET and low-side FET are disabled due to a fault condition, the output voltage discharge mode is enabled, turning on the discharge FET from SW to PGND to discharge the output voltage. The discharge FET is turned off when the converter is ready to resume switching, either after the fault clears or after the wait time before hiccup is over.

The output voltage discharge mode is activated by any of the following fault events:

- High-side or low-side positive overcurrent
- Thermal shutdown
- Output voltage undervoltage
- VIN UVLO

## 7.4 Device Functional Modes

### 7.4.1 Forced Continuous-Conduction Mode

The TPSM843A26 operates in forced continuous-conduction mode (FCCM) throughout normal operation.

### 7.4.2 Discontinuous Conduction Mode During Soft Start

At the beginning of soft start, the converter operates in discontinuous conduction mode (DCM) for the first 16 PWM cycles. During this time, a zero-cross detect comparator is used to turn off the low-side MOSFET when the current reaches zero amps, preventing the discharge of any prebiased conditions on the output. After the 16 cycles of DCM, the converter enters FCCM mode for the remainder of start-up and into regulation.

## 8 Application and Implementation

### Note

Information in the following applications sections is not part of the TI component specification, and TI does not warrant its accuracy or completeness. TI's customers are responsible for determining suitability of components for their purposes, as well as validating and testing their design implementation to confirm system functionality.

### 8.1 Application Information

The TPSM843A26 is a module designed for 4-V to 18-V input and 16-A load. This procedure illustrates the design of a high-frequency switching regulator using ceramic output capacitors.

### 8.2 Typical Applications

#### 8.2.1 1.0-V Output, 1-MHz Application

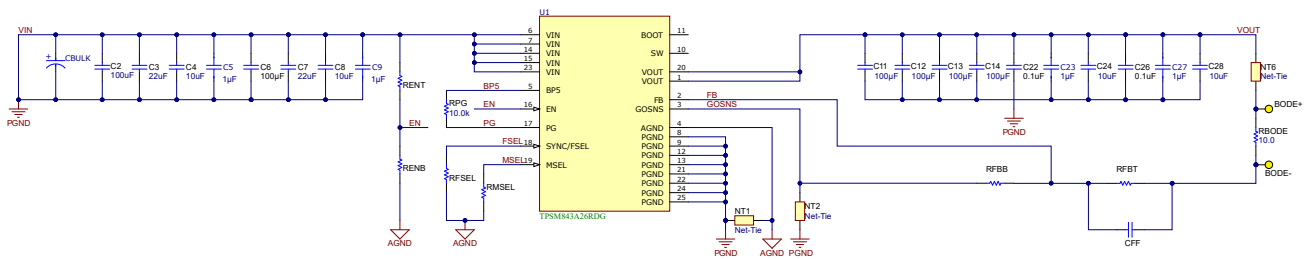

Figure 8-1. 12-V Input, 1.0-V Output, 1-MHz Schematic

#### 8.2.1.1 Design Requirements

For this design example, use the parameters shown in Table 8-1.

Table 8-1. Design Parameters

Parameter	Example Value
Input voltage range ( $V_{IN}$ )	4.1 to 18 V, 12-V nominal
Output voltage ( $V_{OUT}$ )	1.0 V
Output current rating ( $I_{OUT}$ )	16 A
Switching frequency ( $f_{SW}$ )	1000 kHz
Steady state output ripple voltage	10 mV
Output current load step	8 A
Transient response	$\pm 50$ mV ( $\pm 5\%$ )

### 8.2.1.2 Detailed Design Procedure

#### 8.2.1.2.1 Switching Frequency

The first step is to decide on a switching frequency. The TPSM843A26 can operate at five different frequencies from 500 kHz to 2.2 MHz.  $f_{SW}$  is set by the resistor value from the FSEL pin to ground. Typically, the highest switching frequency possible is desired because it produces the smallest solution size. A high switching frequency allows for smaller inductors and output capacitors compared to a power supply that switches at a lower frequency. The main tradeoff made with selecting a higher switching frequency is extra switching power loss, which hurts the efficiency of the regulator.

The maximum switching frequency for a given application can be limited by the minimum on time of the regulator and the maximum  $f_{SW}$  can be estimated with Equation 15. Using the maximum minimum on time of 40 ns and 18.0-V maximum input voltage for this application, the maximum switching frequency is 1389 kHz. The selected switching frequency must also consider the tolerance of the switching frequency. A switching frequency of 1000 kHz was selected for a good balance of solution size and efficiency. To set the frequency to 1000 kHz the selected FSEL resistor is 11.8 k $\Omega$  per Table 7-1.

$$f_{SW}(\max) = \frac{1}{t_{onmin}} \times \frac{V_{OUT}}{V_{IN}(\max)} \quad (15)$$

Figure 8-2 shows the maximum recommended input voltage versus output voltage for each FSEL frequency. This graph uses the maximum minimum on time of 40 ns and includes 10% tolerance on the switching frequency.

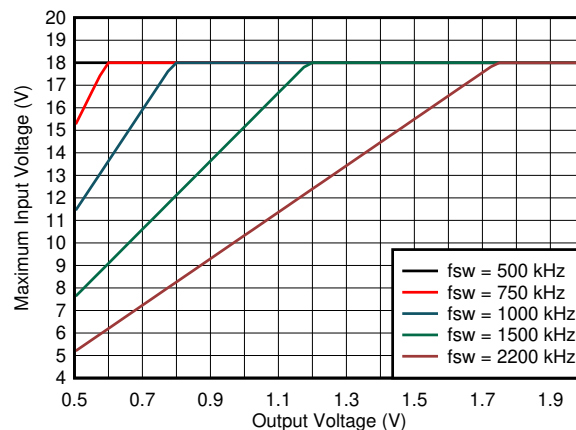

Figure 8-2. Maximum Input Voltage vs Output Voltage

#### 8.2.1.2.2 Output Inductor Selection

An optimized 600-nH inductor is integrated inside the module.

#### 8.2.1.2.3 Output Capacitor

There are two primary considerations for selecting the value of the output capacitor. The output voltage ripple and how the regulator responds to a large change in load current. The output capacitance must be selected based on the more stringent of these criteria.

The desired response to a large change in the load current is the first criteria and is typically the most stringent. A regulator does not respond immediately to a large, fast increase or decrease in load current. The output capacitor supplies or absorbs charge until the regulator responds to the load step. The control loop must sense the change in the output voltage then adjust the peak switch current in response to the change in load. The minimum output capacitance is selected based on an estimate of the loop bandwidth. Typically, the loop bandwidth is near  $f_{SW} / 10$ . Equation 16 estimates the minimum output capacitance necessary.

For this example, the transient load response is specified as a 5% change in  $V_{OUT}$  for a load step of 8 A. Therefore,  $\Delta I_{OUT}$  is 8 A and  $\Delta V_{OUT}$  is 50 mV. Using this target gives a minimum capacitance of 255  $\mu$ F. This

value does not take the ESR of the output capacitor into account in the output voltage change. For ceramic capacitors, the effect of the ESR can be small enough to be ignored. Aluminum electrolytic and tantalum capacitors have higher ESR that must be considered for load step response.

$$C_{OUT} > \frac{\Delta I_{OUT}}{\Delta V_{OUT}} \times \frac{1}{2\pi \times \frac{f_{SW}}{10}} \quad (16)$$

where

- $\Delta I_{OUT}$  is the change in output current.
- $\Delta V_{OUT}$  is the allowable change in the output voltage.

In addition to the loop bandwidth, the inductor current slew rate limiting how quickly the regulator responds to the load step is possible. For low duty cycle applications, the time it takes for the inductor current to ramp down after a load step down can be the limiting factor. Equation 17 estimates the minimum output capacitance necessary to limit the change in the output voltage after a load step down. Using the 600-nH inductance selected gives a minimum capacitance of 250  $\mu$ F.

$$C_{OUT} > \frac{L_{OUT} \times \Delta I_{OUT}^2}{2 \times \Delta V_{OUT} \times V_{OUT}} \quad (17)$$

Equation 18 calculates the minimum output capacitance needed to meet the output voltage ripple specification. In this case, the target maximum steady state output voltage ripple is 10 mV. Under this requirement, Equation 18 yields 19  $\mu$ F.

$$C_o > \frac{1}{8 \times f_{sw}} \times \frac{1}{\frac{V_{ORIPPLE}}{I_{RIPPLE}}} \quad (18)$$

where

- $\Delta I_{OUT}$  is the change in output current.
- $\Delta V_{OUT}$  is the allowable change in the output voltage.
- $f_{SW}$  is the regulators switching frequency.
- $V_{ORIPPLE}$  is the maximum allowable steady state output voltage ripple.
- $I_{RIPPLE}$  is the inductor ripple current.

Lastly, if an application does not have a strict load transient response or output ripple requirement, a minimum amount of capacitance is still required to ensure the control loop is stable with the lowest gain ramp setting on the MSEL pin. Equation 19 estimates the minimum capacitance needed for loop stability. Equation 19 sets the minimum amount of capacitance by keeping the LC frequency relative to the switching frequency at a minimum value. See Figure 8-3 for the limit versus output voltage with the lowest gain ramp setting of 1 pF. With a 1-V output, the minimum ratio is 35 and with this ratio, Equation 19 gives a minimum capacitance of 52  $\mu$ F.

$$C_{OUT} > \left( \frac{\text{Ratio}}{2\pi \times f_{SW}} \right)^2 \times \frac{1}{L_{OUT}} \quad (19)$$

Equation 20 calculates the maximum combined ESR the output capacitors can have to meet the output voltage ripple specification and this shows the ESR must be less than 6 m $\Omega$ . In this case, ceramic capacitors are used and the combined ESR of the ceramic capacitors in parallel is much less than is needed to meet the ripple. Capacitors also have limits to the amount of ripple current they can handle without producing excess heat and failing. An output capacitor that can support the inductor ripple current must be specified. The capacitor data sheet specifies the RMS value of the maximum ripple current. Equation 21 can be used to calculate the RMS

ripple current the output capacitor must support. For this application, Equation 21 yields 0.4 A and ceramic capacitors typically have a ripple current rating much higher than this.

$$Resr < \frac{V_{ripple}}{I_{ripple}} \quad (20)$$

$$I_{corms} = \frac{V_{out} \times (V_{inmax} - V_{out})}{\sqrt{12} \times V_{inmax} \times L1 \times f_{sw}} \quad (21)$$

Select X5R and X7R ceramic dielectrics or equivalent for power regulator capacitors because they have a high capacitance to volume ratio and are fairly stable over temperature. The output capacitor must also be selected with the DC bias and AC voltage derating taken into account. The derated capacitance value of a ceramic capacitor due to DC voltage bias and AC RMS voltage is usually found on the capacitor manufacturer's website. For this application example, four 100- $\mu$ F, 10-V, X5R, 1210 ceramic capacitors each with 3 m $\Omega$  of ESR are used. With the four parallel capacitors, the estimated effective output capacitance after derating using the capacitor manufacturer's website is 380  $\mu$ F. There is about -5% DC bias derating at 1 V. This design was able to use less than the calculated minimum because the loop crossover frequency was above the  $f_{SW} / 10$  estimate as shown in Figure 8-8.

#### 8.2.1.2.4 Input Capacitor

Input decoupling ceramic capacitors type X5R, X7R, or similar from VIN to PGND that are placed as close as possible to the IC are required. A total of at least 66  $\mu$ F of capacitance is required and some applications can require a bulk capacitance. TI recommends at least 1  $\mu$ F of bypass capacitance as close as possible to each VIN pin to minimize the input voltage ripple. A 1- $\mu$ F capacitor must be placed as close as possible to VIN pins 6, 7, 14 and 15 on the same side of the board of the device to provide high frequency bypass to reduce the high frequency overshoot and undershoot on VIN and SW pins. The voltage rating of the input capacitor must be greater than the maximum input voltage. The capacitor must also have a ripple current rating greater than the maximum RMS input current. The RMS input current can be calculated using Equation 22.

For this example design, a ceramic capacitor with at least a 25-V voltage rating is required to support the maximum input voltage. Two 22- $\mu$ F, 1210, X7R, 25-V, two 10- $\mu$ F, 0805, X7S, 25-V, and two 1- $\mu$ F, 0402 or 0603, X7R 25-V capacitors in parallel has been selected to be placed on both sides of the IC near VIN pins to PGND pins. Based on the capacitor manufacturer's website, the total ceramic input capacitance derates to 25  $\mu$ F at the nominal input voltage of 12 V. Additional 100- $\mu$ F ceramic capacitance and 220- $\mu$ F aluminum electrolytic are also used to bypass long leads when connected a lab bench top power supply.

The input capacitance value determines the input ripple voltage of the regulator. The input voltage ripple can be calculated using Equation 23. The maximum input ripple occurs when operating nearest to 50% duty cycle. Using the nominal design example values of  $I_{OUT(MAX)} = 16$  A,  $C_{IN} = 25$   $\mu$ F, and  $f_{SW} = 1000$  kHz, the input voltage ripple with the 12-V nominal input is 48.7 mV and the RMS input ripple current with the 4.5-V minimum input is 6.7 A.

$$I_{CINRMS} = I_{OUT} \times \sqrt{\frac{(V_{INMIN} - V_{OUT})}{V_{INMIN}}} \times \frac{V_{OUT}}{V_{INMIN}} \quad (22)$$

$$\Delta V_{IN} = \frac{I_{OUTMAX} \times \left(1 - \frac{V_{OUT}}{V_{IN}}\right) \times \frac{V_{OUT}}{V_{IN}}}{C_{IN} \times f_{sw}} \quad (23)$$

#### 8.2.1.2.5 Adjustable Undervoltage Lockout

The undervoltage lockout (UVLO) is adjusted using the external voltage divider network of  $R_{ENT}$  and  $R_{ENB}$ . The UVLO has two thresholds: one for power up when the input voltage is rising and one for power down



or brownouts when the input voltage is falling. For the example design, the supply is set to turn on and start switching after the input voltage increases above 4.5 V (UVLO start or enable). After the regulator starts switching, it continues to do so until the input voltage falls below 3.95 V (UVLO stop or disable). In this example, these start and stop voltages set by the EN resistor divider were selected to have more hysteresis than the internally fixed VIN UVLO.

[Equation 1](#) and [Equation 2](#) can be used to calculate the values for the upper and lower resistor values. For these equations to work,  $V_{START}$  must be  $1.1 \times V_{STOP}$  due to the voltage hysteresis of the EN pin. For the voltages specified, the standard resistor value used for  $R_{ENT}$  is 16.9 k $\Omega$  and for  $R_{ENB}$  is 6.04 k $\Omega$ .

#### 8.2.1.2.6 Output Voltage Resistors Selection

The output voltage is set with a resistor divider created by  $R_{FBT}$  and  $R_{FBB}$  from the output node to the FB pin. Use 1% tolerance or better resistors. For this example design, 4.99 k $\Omega$  was selected for  $R_{FBB}$ . Using [Equation 24](#),  $R_{FBT}$  is calculated as 4.99 k $\Omega$ . This resistor is a standard 1% resistor.

$$R_{FBT} = R_{FBB} \times \left( \frac{V_{OUT}}{V_{REF}} - 1 \right) \quad (24)$$

If the PCB layout does not use the recommended AGND to PGND connection in [Section 8.4.1](#), noise on the feedback pin can degrade the output voltage regulation at maximum load. Using a smaller  $R_{FBB}$  of 1.00 k $\Omega$  minimizes the impact of this noise.

#### 8.2.1.2.7 Bootstrap Capacitor Selection

A 0.1- $\mu$ F ceramic capacitor is integrated inside the module connected between the BOOT and SW pin.

A resistor can be added in series with the BOOT capacitor to slow down the turn-on of the high-side MOSFET and reduce overshoot rising edge overshoot on the SW pin. This action comes with the tradeoff of more power loss and lower efficiency. As a best practice, include a 0- $\Omega$  placeholder in prototype designs in case parasitic inductance in the PCB layout results in more voltage overshoot at the SW pin than is normal. This action helps keep the voltage within the ratings of the device and reduces the high frequency noise on the SW node.

#### 8.2.1.2.8 BP5 Capacitor Selection

A 2.2- $\mu$ F and 0.1- $\mu$ F ceramic capacitors are integrated inside the module for proper operation. The BP5 pin is the output of an internal linear regulator as well as the the supply to the gate drivers and analog control circuits.

#### 8.2.1.2.9 PG Pullup Resistor

A 10-k $\Omega$  resistor is used to pull up the power-good signal when FB conditions are met. The pullup voltage source must be less than the 6-V absolute maximum of the PG pin.

#### 8.2.1.2.10 Current Limit Selection

The MSEL pin is used to select between two current limit settings. Select the current limit setting whose minimum is greater than at least 1.1 times the maximum steady state peak current. This selection is to provide margin for component tolerance and load transients. For this design, the minimum current limit must be greater than 7.45 A so the high current limit setting is selected.

#### 8.2.1.2.11 Soft-Start Time Selection

The MSEL pin is used to select between four different soft-start times, which is useful if a load has specific timing requirements for the output voltage of the regulator. A longer soft-start time is also useful if the output capacitance is very large and requires large amounts of current to quickly charge the output capacitors to the output voltage level. The large currents necessary to charge the capacitor can reach the current limit or cause the input voltage rail to sag due excessive current draw from the input power supply. Limiting the output voltage slew rate solves both of these problems. The example design has the soft-start time set to 2.0 ms.

### 8.2.1.2.12 Ramp Selection and Control Loop Stability

The MSEL pin is used to select between three different ramp settings. The most optimal ramp setting depends on  $V_{OUT}$ ,  $f_{SW}$ ,  $L_{OUT}$ , and  $C_{OUT}$ . To get started, calculate LC double pole frequency using [Equation 25](#). Then calculate the ratio between  $f_{SW}$  and  $f_{LC}$ . Based on this ratio and the output voltage, select the recommended ramp setting using [Figure 8-3](#). With a 1-V output, TI recommends the 1-pF ramp for ratios between approximately 35 and 58, TI recommends the 2-pF ramp for ratios between approximately 58 and 86, and TI recommends the 4-pF ramp for ratios greater than approximately 86. In general, use the largest ramp capacitor the design can support. Increasing the ramp capacitor improves transient response but can reduce stability margin or increase on-time jitter.

For this design,  $f_{LC}$  is 11.2 kHz and the ratio is 89.3 which is on the border of the 1-pF and 2-pF ramp settings. Through bench evaluation, it was found the design had sufficient stability margin with the 2-pF ramp so this setting was selected for the best transient response. The recommended ramp settings given by [Figure 8-3](#) include margin to account for potential component tolerances and variations across operating conditions so it is possible to use a higher ramp setting as shown in this example.

$$f_{LC} = \frac{1}{2 \times \pi \times \sqrt{L_{OUT} \times C_{OUT}}} \quad (25)$$

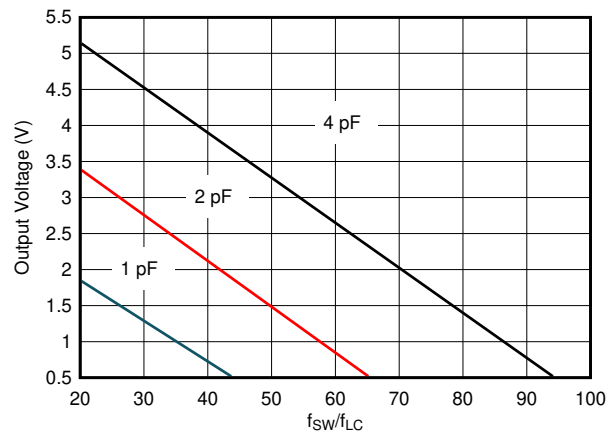

**Figure 8-3. Recommended Ramp Settings**

Use a feedforward capacitor ( $C_{FF}$ ) in parallel with the upper feedback resistor ( $R_{FBT}$ ) to add a zero into the control loop to provide phase boost. Include a placeholder for this capacitor as the zero it provides can be required to meet phase margin requirements. This capacitor also adds a pole at a higher frequency than the zero. The pole and zero frequency are not independent so as a result, after the zero location is chosen, the pole is fixed as well. The zero is placed at  $1/4$  the  $f_{SW}$  by calculating the value of  $C_{FF}$  with [Equation 26](#). The calculated value is 64 pF — round this down to the closest standard value of 56 pF.

Using bench measurements of the AC response, the feedforward capacitor for this example design was increased to 100 pF to improve the transient response.

$$C_{FF} = \frac{1}{\pi \times R_{FBT} \times \frac{f_{SW}}{2}} \quad (26)$$

Using larger feedforward capacitors to further improve the transient response is possible, but take care to ensure there is a minimum of –9-dB gain margin in all operating conditions. The feedforward capacitor injects noise on the output into the FB pin. This added noise can result in increased on-time jitter at the switching node. Too little gain margin can cause a repeated wide and narrow pulse behavior. Adding a 100-Ω resistor in series with the feedforward capacitor can help reduce the impact of noise on the FB pin in case of non-ideal PCB layout. The value of this resistor must be kept small as larger values bring the feedforward pole and zero closer together degrading the phase boost the feedforward capacitor provides.

When using higher ESR output capacitors, such as polymer or tantalum, their ESR zero ( $f_{\text{ESR}}$ ) must be accounted for. The ESR zero can be calculated using [Equation 27](#). If the ESR zero frequency is less than the estimated bandwidth of 1/10th the  $f_{\text{SW}}$ , it can affect the gain margin and phase margin. A series R-C from the FB pin to ground can be used to add a pole into the control loop if necessary. All ceramic capacitors are used in this design so the effect of the ESR zero is ignored.

$$f_{\text{ESR}} = \frac{1}{2 \times \pi \times C_{\text{OUT}} \times R_{\text{ESR}}} \quad (27)$$

#### 8.2.1.2.13 MSEL Pin

The MSEL resistor is set to 4.87 kΩ to select the high current limit setting, 2.0-ms soft-start, and the 2-pF ramp. See [Table 7-5](#) for the full list of the MSEL pin settings.

### 8.2.1.3 Application Curves

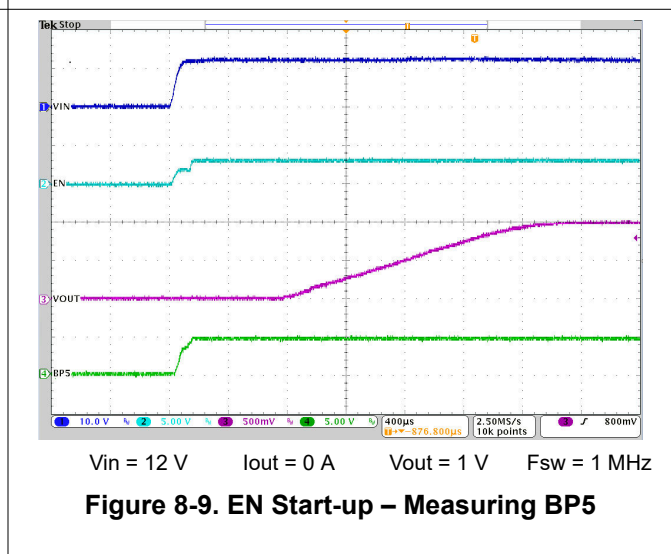
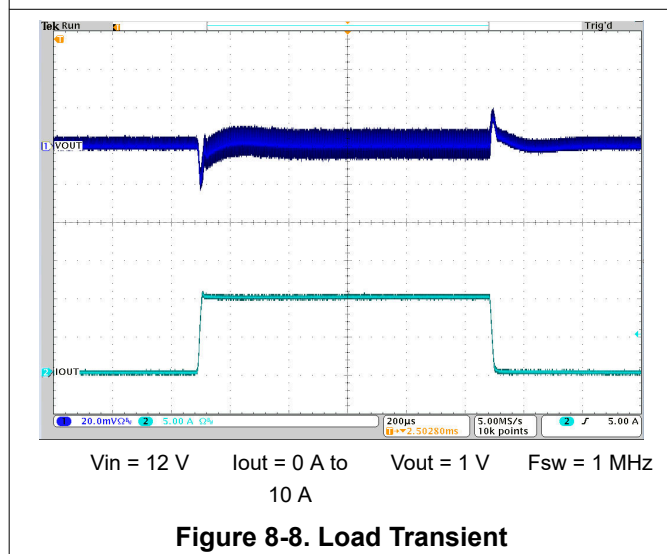
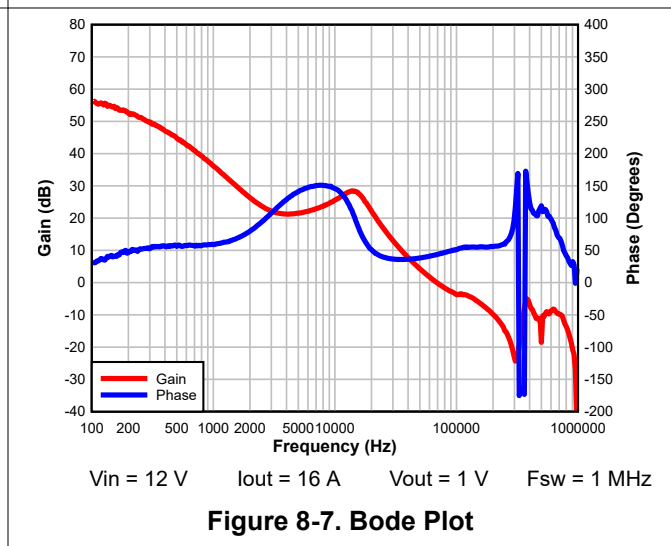
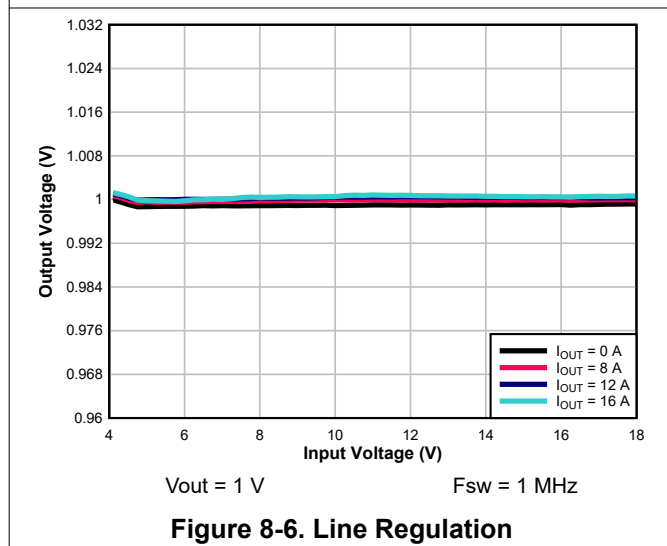
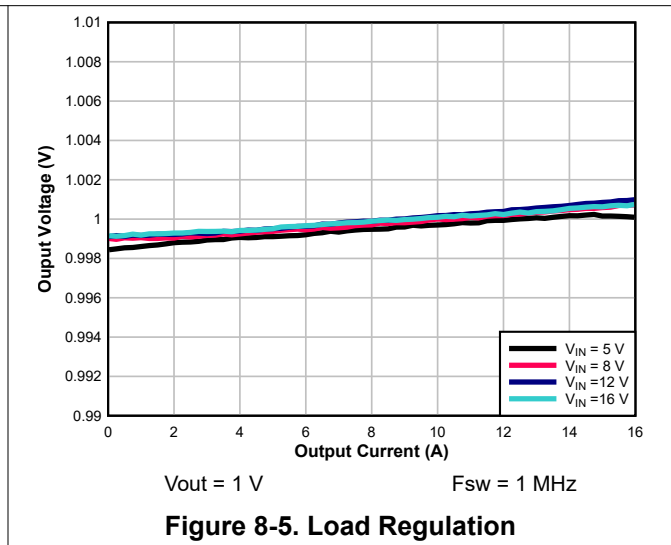
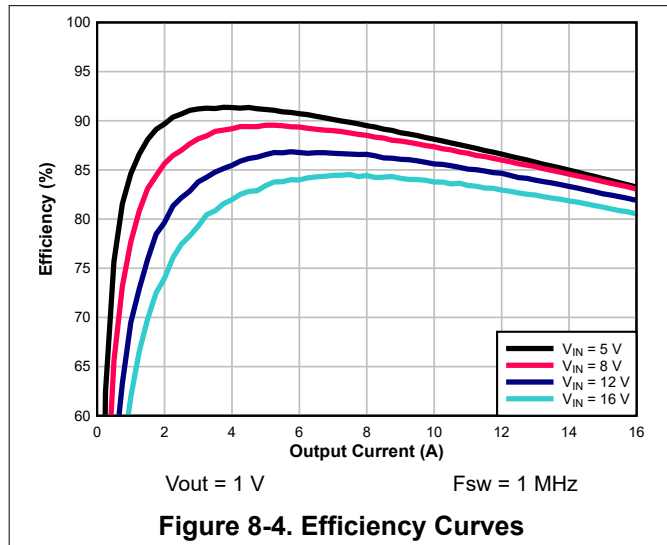

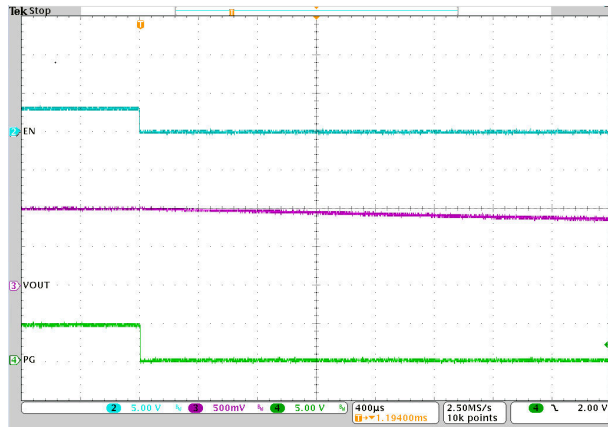

Vin = 12 V Iout = 0 A Vout = 1 V Fsw = 1 MHz

**Figure 8-10. EN Shutdown**

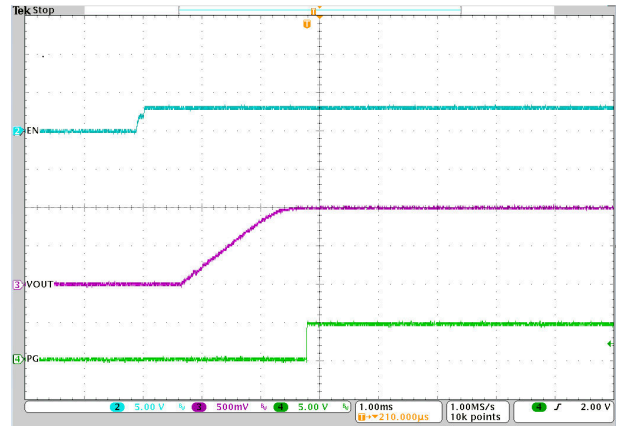

Vin = 12 V Iout = 8 A Vout = 1 V Fsw = 1 MHz

**Figure 8-11. EN Start-up – With Load**

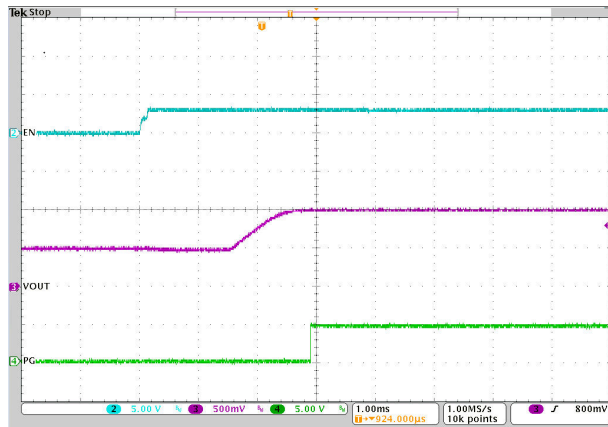

Vin = 12 V Iout = 0 A Vout = 1 V Fsw = 1 MHz

**Figure 8-12. EN Start-up – 0.5-V Prebias**

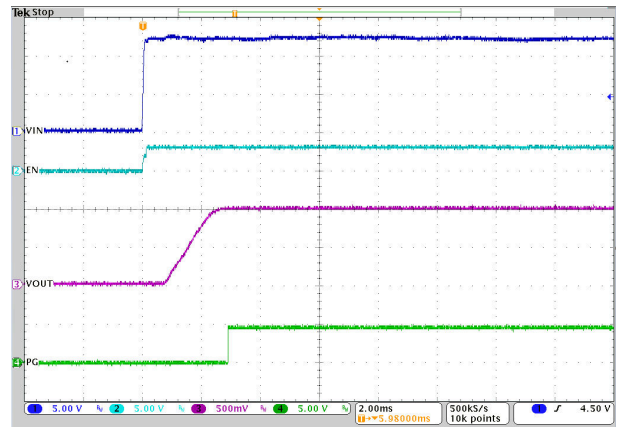

Vin = 12 V Iout = 0 A Vout = 1 V Fsw = 1 MHz

**Figure 8-13. VIN Start-Up**

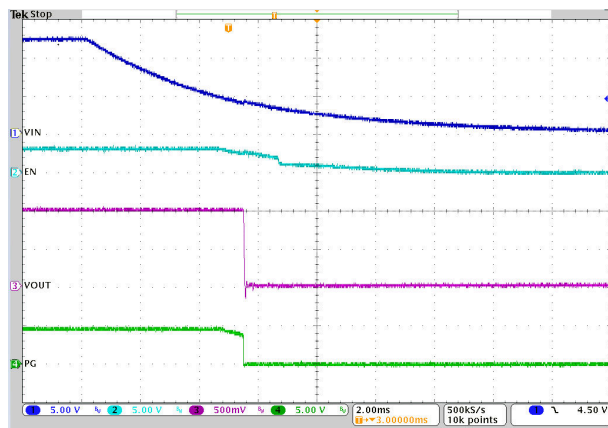

Vin = 12 V Iout = 8 A Vout = 1 V Fsw = 1 MHz

**Figure 8-14. VIN Shutdown**

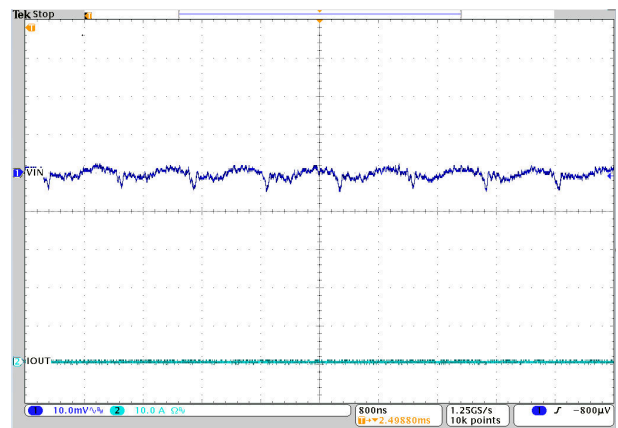

Vin = 12 V Iout = 0 A Vout = 1 V Fsw = 1 MHz

**Figure 8-15. Input Ripple – No Load**

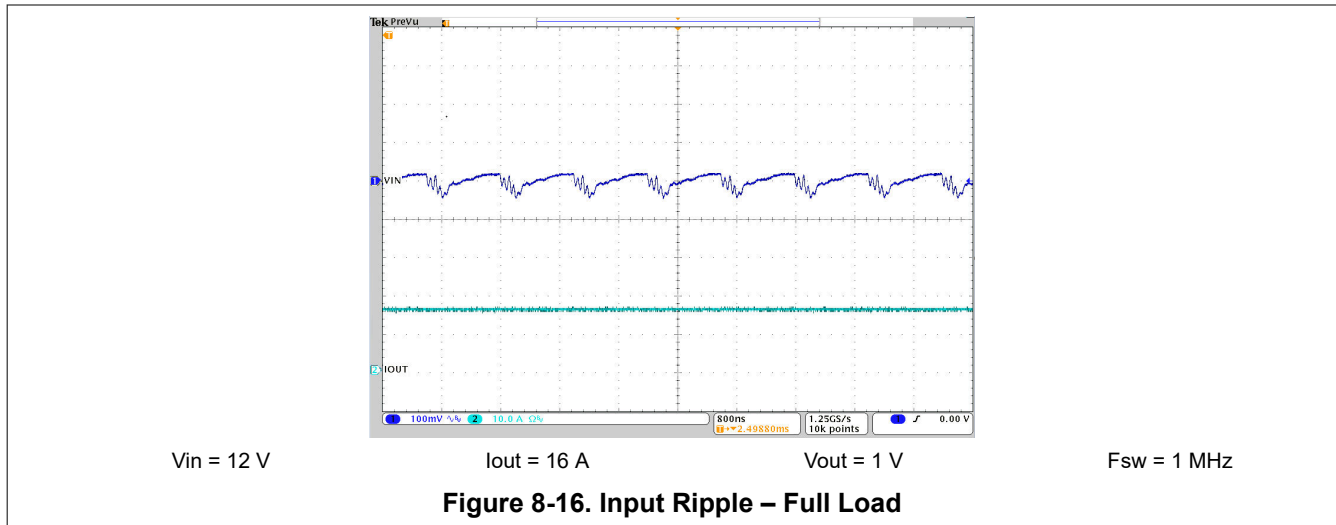

### 8.3 Power Supply Recommendations

The TPSM843A26 is designed to operate from an input voltage supply range between 4 V and 18 V. This supply voltage must be well regulated. Proper bypassing of the input supply is critical for proper electrical performance, as is the PCB layout and the grounding scheme. A minimum of 10- $\mu$ F (after derating) ceramic capacitance, type X5R or better, must be placed near the device. TI recommends splitting the ceramic input capacitance equally between the VIN and PGND pins on each side of the device resulting in at least 5  $\mu$ F of ceramic capacitance on each side of the device.

### 8.4 Layout

#### 8.4.1 Layout Guidelines

Layout is a critical portion of good power supply design. See [Figure 8-17](#) for a PCB layout example. Key guidelines to follow for the layout are:

- Make VIN, PGND, and SW traces as wide as possible to reduce trace impedance and improve heat dissipation. Use vias and traces on others layers to reduce VIN and PGND trace impedance.
- Use multiple vias near the PGND pins and use the layer directly below the device to connect them together, which helps to minimize noise and can help heat dissipation.
- Use vias near both VIN pins and provide a low impedance connection between them through an internal layer.
- Place a 1- $\mu$ F/25-V/X6R or better dielectric ceramic capacitors from each VIN to PGND pins and place them as close as possible to the device on the same side of the PCB. Place the remaining ceramic input capacitance next to these high frequency bypass capacitors. The remaining input capacitance can be placed on the other side of the board but use as many vias as possible to minimize impedance between the capacitors and the pins of the IC.
- Place the inductor as close as possible to the device to minimize the length of the SW node routing.
- Place the bottom resistor in the FB divider as close as possible to the FB and GOSNS pins of the IC. Also keep the upper feedback resistor and the feedforward capacitor near the IC. Connect the FB divider to the output voltage at the desired point of regulation.
- Use vias on the AGND islands on top layer to connect to AGND layer island on an internal layer. Connect the internal AGND island to PGND at one point.
- Return the FSEL and MSEL resistors to a quiet AGND island.

### 8.4.2 Layout Example

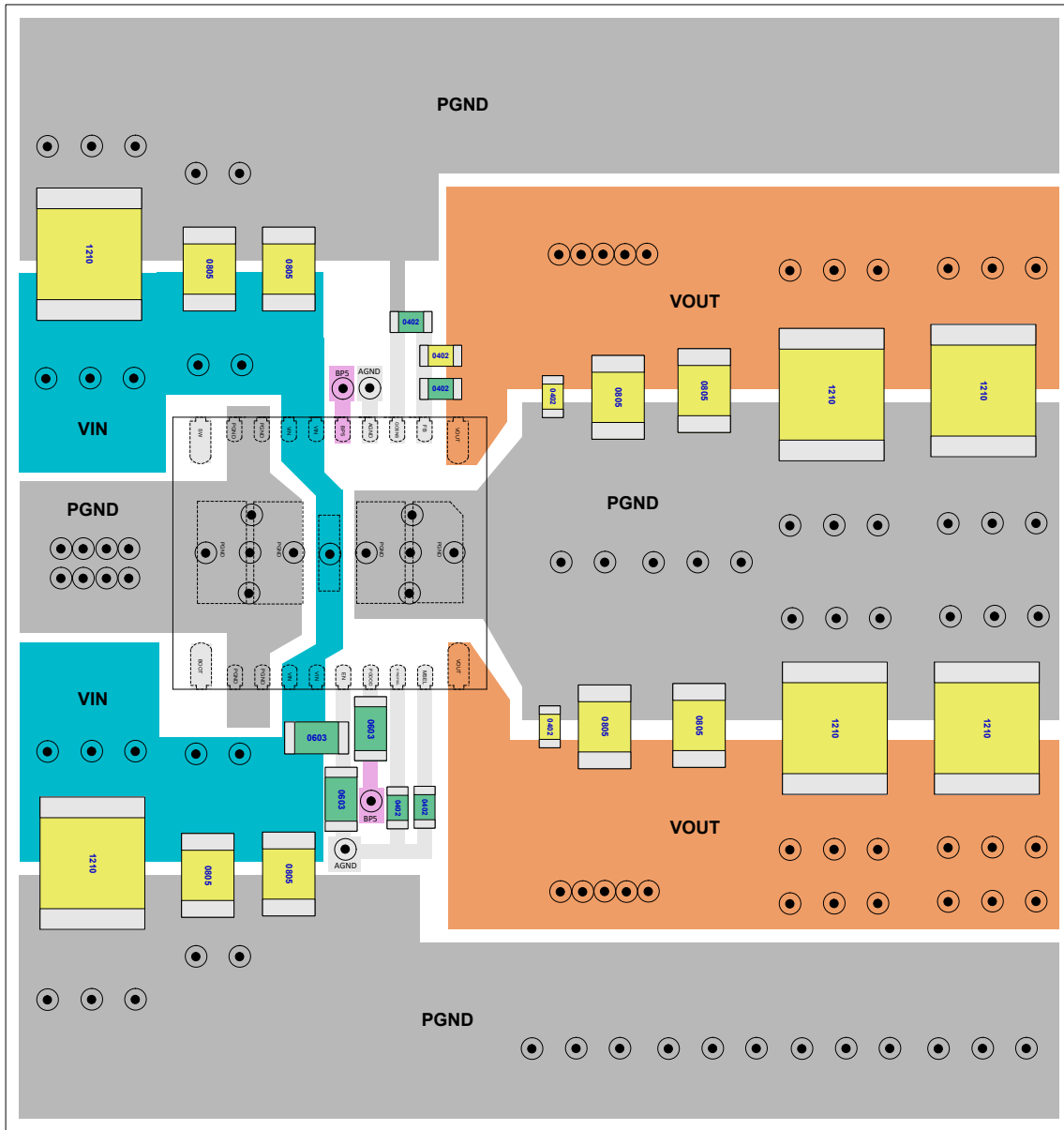

Figure 8-17. Example PCB Layout



### 8.4.3 Thermal Performance

Test conditions:  $f_{SW} = 1 \text{ MHz}$ ,  $V_{IN} = 12 \text{ V}$ ,  $V_{OUT} = 1 \text{ V}$ ,  $I_{OUT} = 16\text{A}$ , ambient temperature =  $25^\circ\text{C}$

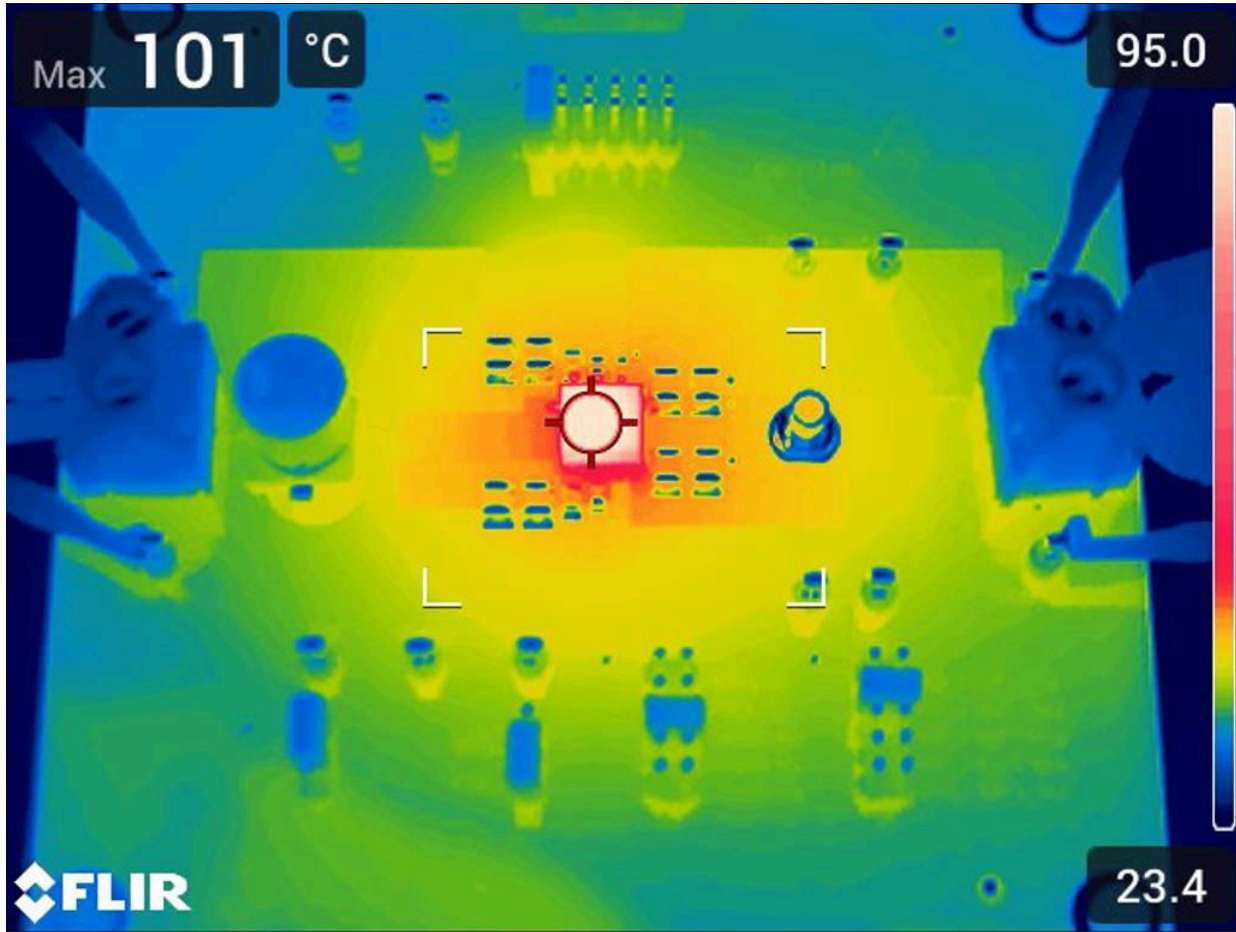

Figure 8-18. Thermal Image at  $25^\circ\text{C}$  Ambient



## 9 Device and Documentation Support

### 9.1 Receiving Notification of Documentation Updates

To receive notification of documentation updates, navigate to the device product folder on [ti.com](https://www.ti.com). Click on *Subscribe to updates* to register and receive a weekly digest of any product information that has changed. For change details, review the revision history included in any revised document.

### 9.2 Support Resources

[TI E2E™ support forums](#) are an engineer's go-to source for fast, verified answers and design help — straight from the experts. Search existing answers or ask your own question to get the quick design help you need.

Linked content is provided "AS IS" by the respective contributors. They do not constitute TI specifications and do not necessarily reflect TI's views; see TI's [Terms of Use](#).

### 9.3 Trademarks

TI E2E™ is a trademark of Texas Instruments.  
All trademarks are the property of their respective owners.

### 9.4 Electrostatic Discharge Caution



This integrated circuit can be damaged by ESD. Texas Instruments recommends that all integrated circuits be handled with appropriate precautions. Failure to observe proper handling and installation procedures can cause damage.

ESD damage can range from subtle performance degradation to complete device failure. Precision integrated circuits may be more susceptible to damage because very small parametric changes could cause the device not to meet its published specifications.

### 9.5 Glossary

[TI Glossary](#) This glossary lists and explains terms, acronyms, and definitions.

## 10 Mechanical, Packaging, and Orderable Information

The following pages include mechanical, packaging, and orderable information. This information is the most current data available for the designated devices. This data is subject to change without notice and revision of this document. For browser-based versions of this data sheet, refer to the left-hand navigation.

## PACKAGING INFORMATION

Orderable part number	Status (1)	Material type (2)	Package   Pins	Package qty   Carrier	RoHS (3)	Lead finish/ Ball material (4)	MSL rating/ Peak reflow (5)	Op temp (°C)	Part marking (6)
<a href="#">TPSM843A26RDGR</a>	Active	Production	B3QFN (RDG)   25	1000   LARGE T&R	Yes	NIPDAU	Level-3-250C-168 HR	-40 to 125	TPSM3A26
TPSM843A26RDGR.A	Active	Production	B3QFN (RDG)   25	1000   LARGE T&R	Yes	NIPDAU	Level-3-250C-168 HR	-40 to 125	TPSM3A26
TPSM843A26RDGR.B	Active	Production	B3QFN (RDG)   25	1000   LARGE T&R	-	Call TI	Call TI	-40 to 125	

(1) **Status:** For more details on status, see our [product life cycle](#).

(2) **Material type:** When designated, preproduction parts are prototypes/experimental devices, and are not yet approved or released for full production. Testing and final process, including without limitation quality assurance, reliability performance testing, and/or process qualification, may not yet be complete, and this item is subject to further changes or possible discontinuation. If available for ordering, purchases will be subject to an additional waiver at checkout, and are intended for early internal evaluation purposes only. These items are sold without warranties of any kind.

(3) **RoHS values:** Yes, No, RoHS Exempt. See the [TI RoHS Statement](#) for additional information and value definition.

(4) **Lead finish/Ball material:** Parts may have multiple material finish options. Finish options are separated by a vertical ruled line. Lead finish/Ball material values may wrap to two lines if the finish value exceeds the maximum column width.

(5) **MSL rating/Peak reflow:** The moisture sensitivity level ratings and peak solder (reflow) temperatures. In the event that a part has multiple moisture sensitivity ratings, only the lowest level per JEDEC standards is shown. Refer to the shipping label for the actual reflow temperature that will be used to mount the part to the printed circuit board.

(6) **Part marking:** There may be an additional marking, which relates to the logo, the lot trace code information, or the environmental category of the part.

Multiple part markings will be inside parentheses. Only one part marking contained in parentheses and separated by a "-" will appear on a part. If a line is indented then it is a continuation of the previous line and the two combined represent the entire part marking for that device.

**Important Information and Disclaimer:** The information provided on this page represents TI's knowledge and belief as of the date that it is provided. TI bases its knowledge and belief on information provided by third parties, and makes no representation or warranty as to the accuracy of such information. Efforts are underway to better integrate information from third parties. TI has taken and continues to take reasonable steps to provide representative and accurate information but may not have conducted destructive testing or chemical analysis on incoming materials and chemicals. TI and TI suppliers consider certain information to be proprietary, and thus CAS numbers and other limited information may not be available for release.

In no event shall TI's liability arising out of such information exceed the total purchase price of the TI part(s) at issue in this document sold by TI to Customer on an annual basis.

**TAPE AND REEL INFORMATION**

**QUADRANT ASSIGNMENTS FOR PIN 1 ORIENTATION IN TAPE**



\*All dimensions are nominal

Device	Package Type	Package Drawing	Pins	SPQ	Reel Diameter (mm)	Reel Width W1 (mm)	A0 (mm)	B0 (mm)	K0 (mm)	P1 (mm)	W (mm)	Pin1 Quadrant
TPSM843A26RDGR	B3QFN	RDG	25	1000	330.0	16.4	6.9	7.9	4.3	12.0	16.0	Q1

**TAPE AND REEL BOX DIMENSIONS**

\*All dimensions are nominal

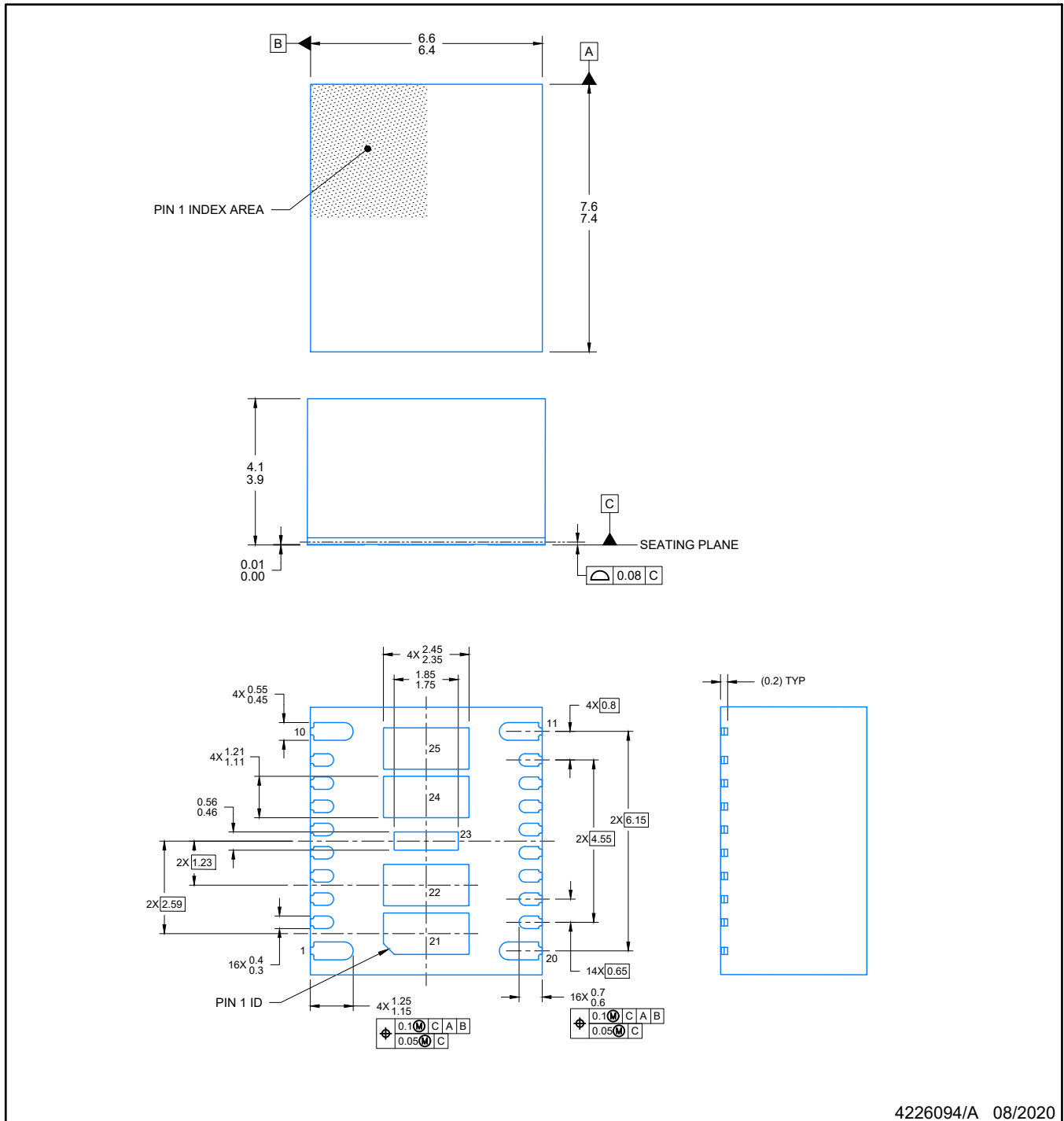
Device	Package Type	Package Drawing	Pins	SPQ	Length (mm)	Width (mm)	Height (mm)
TPSM843A26RDGR	B3QFN	RDG	25	1000	336.0	336.0	48.0



4226094/A 08/2020

**NOTES:**

1. All linear dimensions are in millimeters. Any dimensions in parenthesis are for reference only. Dimensioning and tolerancing per ASME Y14.5M.
2. This drawing is subject to change without notice.
3. The package thermal pad must be soldered to the printed circuit board for optimal thermal and mechanical performance.

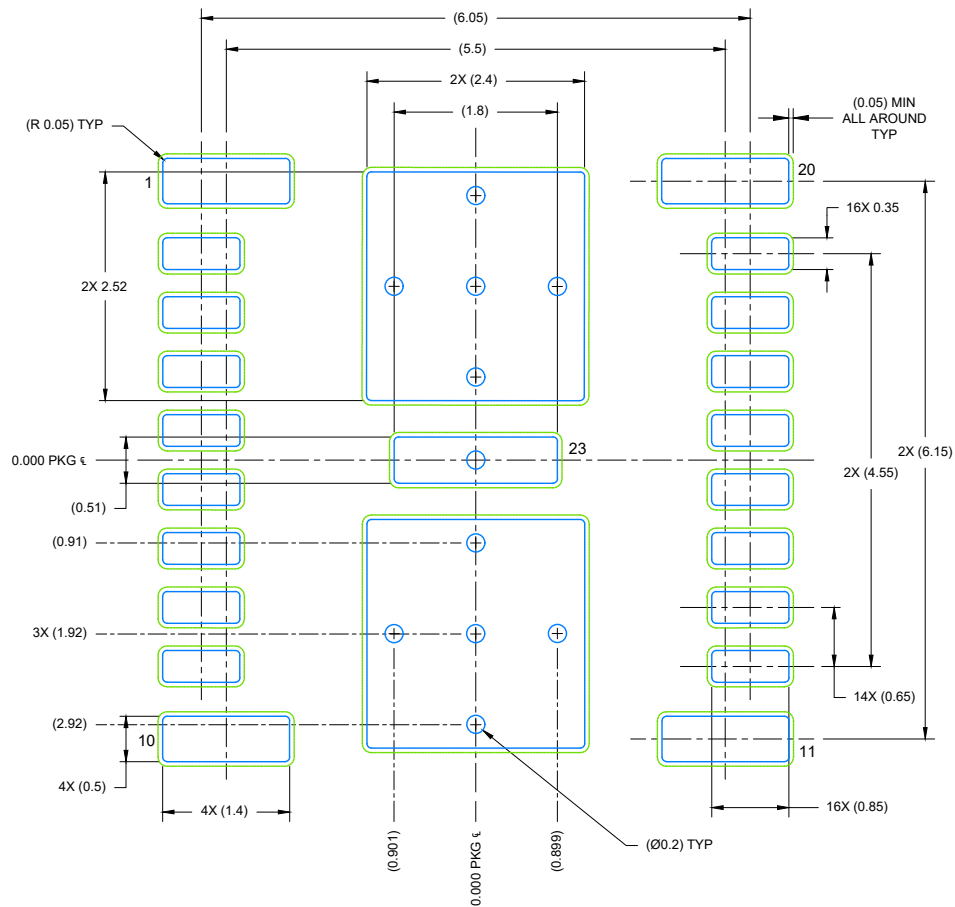

LAND PATTERN EXAMPLE  
EXPOSED METAL SHOWN  
SCALE: 12X

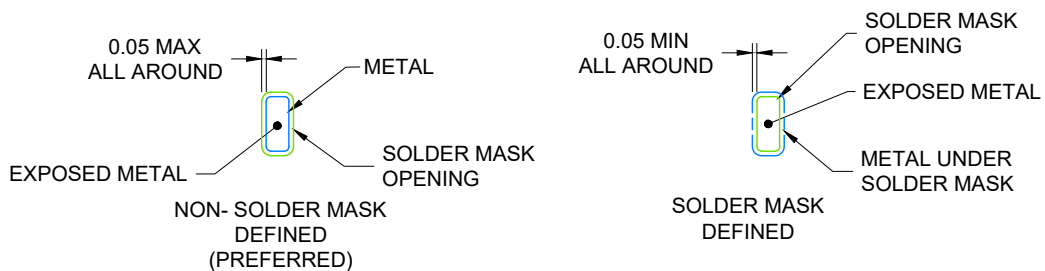

SOLDER MASK DETAILS

4226094/A 08/2020

NOTES: (continued)

- This package is designed to be soldered to a thermal pad on the board. For more information, see Texas Instruments literature number SLUA271 ([www.ti.com/lit/slua271](http://www.ti.com/lit/slua271)).
- Vias are optional depending on application, refer to device data sheet. If any vias are implemented, refer to their locations shown on this view. It is recommended that vias under paste be filled, plugged or tented.

# EXAMPLE STENCIL DESIGN

RDG0025A

B3QFN - 4.1 mm max height

PLASTIC QUAD FLAT PACK- NO LEAD

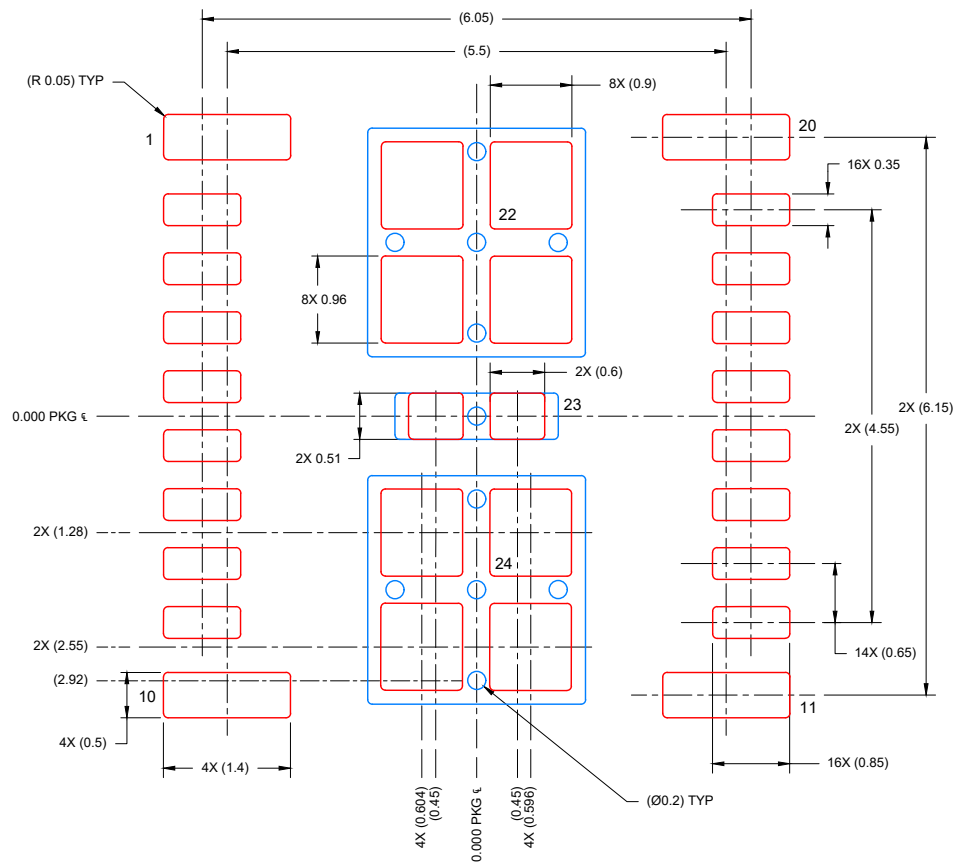

**SOLDER PASTE EXAMPLE**  
BASED ON 0.1 mm THICK STENCIL

**SOLDER COVERAGE:**

PIN 21 & 22 : 57%  
PIN 23 : 67%  
PIN 24 & 25 : 57%

SCALE: 15X

4226094/A 08/2020

NOTES: (continued)

6. Laser cutting apertures with trapezoidal walls and rounded corners may offer better paste release. IPC-7525 may have alternate design recommendations.

## IMPORTANT NOTICE AND DISCLAIMER

TI PROVIDES TECHNICAL AND RELIABILITY DATA (INCLUDING DATASHEETS), DESIGN RESOURCES (INCLUDING REFERENCE DESIGNS), APPLICATION OR OTHER DESIGN ADVICE, WEB TOOLS, SAFETY INFORMATION, AND OTHER RESOURCES "AS IS" AND WITH ALL FAULTS, AND DISCLAIMS ALL WARRANTIES, EXPRESS AND IMPLIED, INCLUDING WITHOUT LIMITATION ANY IMPLIED WARRANTIES OF MERCHANTABILITY, FITNESS FOR A PARTICULAR PURPOSE OR NON-INFRINGEMENT OF THIRD PARTY INTELLECTUAL PROPERTY RIGHTS.

These resources are intended for skilled developers designing with TI products. You are solely responsible for (1) selecting the appropriate TI products for your application, (2) designing, validating and testing your application, and (3) ensuring your application meets applicable standards, and any other safety, security, regulatory or other requirements.

These resources are subject to change without notice. TI grants you permission to use these resources only for development of an application that uses the TI products described in the resource. Other reproduction and display of these resources is prohibited. No license is granted to any other TI intellectual property right or to any third party intellectual property right. TI disclaims responsibility for, and you fully indemnify TI and its representatives against any claims, damages, costs, losses, and liabilities arising out of your use of these resources.

TI's products are provided subject to [TI's Terms of Sale](#), [TI's General Quality Guidelines](#), or other applicable terms available either on [ti.com](#) or provided in conjunction with such TI products. TI's provision of these resources does not expand or otherwise alter TI's applicable warranties or warranty disclaimers for TI products. Unless TI explicitly designates a product as custom or customer-specified, TI products are standard, catalog, general purpose devices.

TI objects to and rejects any additional or different terms you may propose.

Copyright © 2025, Texas Instruments Incorporated

Last updated 10/2025