

TPSM8282x, TPSM8282xA 1-A, 2-A, and 3-A High Efficiency Step-Down Converter MicroSiP™ Power Module with Integrated Inductor

1 Features

- 1.1-mm profile MicroSiP™ power module
- CISPR 11 class B compliant
- Up to 95% efficiency
- 2.4-V to 5.5-V input voltage range
- 0.6-V to 4-V adjustable output voltage
- Fixed output voltages available: 1.2-V, 1.8-V, 2.5-V and 3.3-V
- 4- μ A operating quiescent current
- DCS-control topology
- Power save mode option available for light load efficiency
- Forced-PWM option available for CCM operation
- 100% duty cycle for lowest dropout
- Hiccup short circuit protection
- Output discharge
- Power good output with window comparator
- Integrated soft start-up
- Overtemperature protection
- PSPICE models available for: [TPSM82821](#), [TPSM82822](#) and [TPSM82823](#)
- 2.0-mm \times 2.5-mm \times 1.1-mm 10-pin μ SiL package
- 12 mm² total solution size (for the fixed output voltage versions)

2 Applications

- [Optical modules](#)
- [Machine vision](#)
- [Industrial PCs](#)
- [PLCs](#)
- [Wired Networking](#)

3 Description

The TPSM8282x device family consists of a 1-A, 2-A, and 3-A step-down converter MicroSiP™ power modules optimized for small solution size and high efficiency.

The power modules integrate a synchronous step-down converter and an inductor to simplify design, reduce external components and save PCB area. The TPSM8282x is available in two flavors. The first includes an automatically entered power save mode to maintain high efficiency down to very light loads for extending the system battery run-time. The second version, the TPSM8282xA, runs in forced-PWM maintaining a continuous conduction mode at all currents to minimize the output ripple. In PWM mode the converter operates with a nominal switching frequency of 4MHz.

In power save mode, the device operates with typically 4- μ A quiescent current. Using the DCS-Control topology, the device achieves excellent load transient performance and accurate output voltage regulation. The EN and PG pins, which support sequencing configurations, bring a flexible system design. An integrated soft start-up reduces the inrush current required from the input supply. Overtemperature protection and hiccup short circuit protection deliver a robust and reliable solution.

Device Information

PART NUMBER ⁽¹⁾	PACKAGE	BODY SIZE (NOM)
TPSM82821xSILR	μ SiL (10)	2.0 mm \times 2.5 mm
TPSM82822xSILR		
TPSM82823xSILR		

- (1) For all available packages, see the orderable addendum at the end of the data sheet.

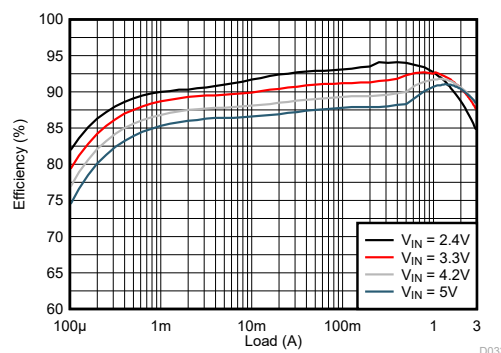
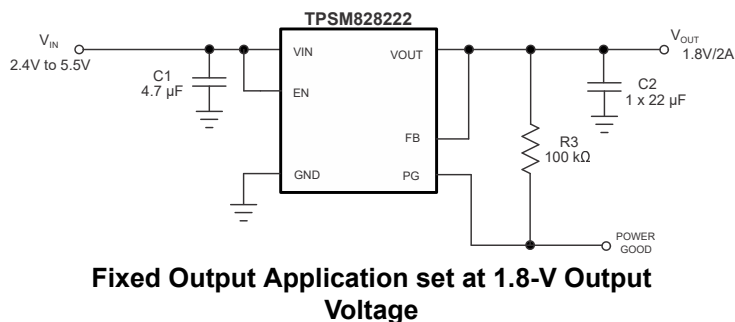

Table of Contents

1 Features	1	8.3 Feature Description.....	7
2 Applications	1	8.4 Device Functional Modes.....	10
3 Description	1	9 Application and Implementation	11
4 Revision History	2	9.1 Application Information.....	11
5 Device Comparison Table	3	9.2 Typical Applications.....	11
6 Pin Configuration and Functions	3	10 Power Supply Recommendations	42
7 Specifications	4	11 Layout	42
7.1 Absolute Maximum Ratings.....	4	11.1 Layout Guidelines.....	42
7.2 ESD Ratings.....	4	11.2 Layout Example.....	42
7.3 Recommended Operating Conditions.....	4	12 Device and Documentation Support	44
7.4 Thermal Information.....	4	12.1 Device Support.....	44
7.5 Electrical Characteristics.....	5	12.2 Documentation Support.....	44
7.6 Typical Characteristics.....	6	12.3 Receiving Notification of Documentation Updates.....	44
8 Detailed Description	7	12.4 Trademarks.....	44
8.1 Overview.....	7	12.5 Electrostatic Discharge Caution.....	44
8.2 Functional Block Diagram.....	7	12.6 Glossary.....	44

4 Revision History

NOTE: Page numbers for previous revisions may differ from page numbers in the current version.

Changes from Revision E (May 2021) to Revision F (November 2021)	Page
• Updated description on first page to include the FPWM device.....	1
• Added FPWM devices.....	3
• Updated Section 8.3.1 to clarify the addition of the FPWM devices.....	7
• Added application curves for all new FPWM devices.....	14
• Added tape and reel information for FPWM devices.....	45

Changes from Revision D (March 2021) to Revision E (May 2021)	Page
• Released TPSM82823.....	1
• Updated the first bullet in the <i>Features</i>	1
• Added PSPICE bullet to the <i>Features</i>	1
• Updated <i>Applications</i>	1
• Changed name of the first column of the <i>Device Comparison Table</i> to "Orderable Part Number".....	3
• Fixed slight error in the <i>Functional Block Diagram</i>	7
• Added Equation 2	7
• Updated Figure 9-1 to have an output capacitor option of $1 \times 22 \mu\text{F}$	11
• Expanded Table 9-1 with more choices of capacitors.....	12
• Added EMI measurement plots to show CISPR compliance.....	14
• Added SOA curves for the TPSM82823.....	33
• Added Section 12.1.2.1	44

5 Device Comparison Table

ORDERABLE PART NUMBER	OUTPUT VOLTAGE	MODE OF OPERATION	OUTPUT CURRENT
TPSM82821SILR	adjustable	Power save mode	1 A
TPSM828211SILR	1.2 V		
TPSM828212SILR	1.8 V		
TPSM828213SILR	2.5 V		
TPSM828214SILR	3.3 V		
TPSM82821ASILR	adjustable	Forced PWM	2 A
TPSM82822SILR	adjustable	Power save mode	
TPSM828221SILR	1.2 V		
TPSM828222SILR	1.8 V		
TPSM828223SILR	2.5 V		
TPSM828224SILR	3.3 V	Forced PWM	
TPSM82822ASILR	adjustable		
TPSM82823SILR	adjustable		Power save mode
TPSM82823ASILR	adjustable	Forced PWM	

6 Pin Configuration and Functions

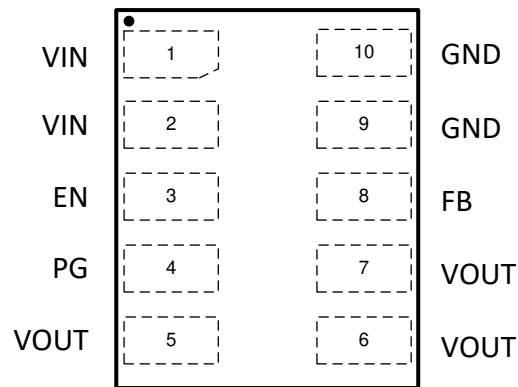

Figure 6-1. μSiL Package (Top View)

Table 6-1. Pin Functions

PIN		I/O	DESCRIPTION
NAME	NO.		
EN	3	I	Device enable pin. To enable the device, this pin needs to be pulled high. Pulling this pin low disables the device. Do not leave floating.
FB	8	I	Feedback pin. This pin must be connected to the center of the output voltage resistor divider. For the fixed output voltage devices, connect this pin directly to the output voltage.
GND	9, 10	PWR	Ground pin
PG	4	O	Power-good open-drain output pin with window comparator. The pullup resistor can be connected to voltages up to 5.5 V. If unused, leave it floating.
VIN	1, 2	PWR	Input voltage pin
VOUT	5, 6, 7	PWR	Output voltage pin

7 Specifications

7.1 Absolute Maximum Ratings

Over operating junction temperature range (unless otherwise noted) ⁽¹⁾

		MIN	MAX	UNIT
Pin voltage	VIN, VOUT, FB, EN, PG ⁽²⁾	-0.3	6	V
ISINK_PG	Sink current at PG pin		1	mA
TJ	Operating junction temperature	-40	125	°C
Tstg	Storage temperature	-55	125	°C

- (1) Stresses beyond those listed under *Absolute Maximum Ratings* may cause permanent damage to the device. These are stress ratings only, which do not imply functional operation of the device at these or any other conditions beyond those indicated under *Recommended Operating Conditions*. Exposure to absolute-maximum-rated conditions for extended periods may affect device reliability.
- (2) All voltage values are with respect to the network ground terminal.

7.2 ESD Ratings

			VALUE	UNIT
V(ESD)	Electrostatic discharge	Human body model (HBM), per ANSI/ESDA/JEDEC JS-001, all pins ⁽¹⁾	±2000	V
		Charged device model (CDM), per JEDEC specification JESD22-C101, all pins ⁽²⁾	±1000	

- (1) JEDEC document JEP155 states that 500-V HBM allows safe manufacturing with a standard ESD control process.
- (2) JEDEC document JEP157 states that 250-V CDM allows safe manufacturing with a standard ESD control process.

7.3 Recommended Operating Conditions

		MIN	MAX	UNIT
VIN	Input voltage	2.4	5.5	V
VOUT	Output voltage range	0.6	4	V
VPG	Pullup resistor voltage		5.5	V
IOUT	Output current range, TPSM82821, TPSM82821A ⁽¹⁾	0	1	A
	Output current range, TPSM82822, TPSM82822A ⁽¹⁾	0	2	
	Output current range, TPSM82823, TPSM82823A ⁽¹⁾	0	3	
TJ	Junction temperature ⁽¹⁾	-40	125	°C

- (1) In applications where high power dissipation and high ambient temperatures are present, the maximum output current must be derated to operate the module within its operating temperature range. See [Section 11.2.1](#).

7.4 Thermal Information

THERMAL METRIC ⁽¹⁾		TPSM8282x		UNIT
		µSiL (JEDEC 51-7)	TPSM8282xEVM-080 TPSM8282xAEVM-127	
		10-PINS		
RθJA	Junction-to-ambient thermal resistance	92.6	64.3	°C/W
RθJC(top)	Junction-to-case (top) thermal resistance	49.6	n/a ⁽²⁾	°C/W
RθJB	Junction-to-board thermal resistance	27.7	n/a ⁽²⁾	°C/W
ψJT	Junction-to-top characterization parameter	5.8	4.3	°C/W
ψJB	Junction-to-board characterization parameter	26.9	22.4	°C/W

- (1) For more information about traditional and new thermal metrics, see the [Semiconductor and IC Package Thermal Metrics](#) application report.
- (2) Not applicable to an EVM.

7.5 Electrical Characteristics

$T_J = -40^{\circ}\text{C}$ to 125°C and $V_{IN} = 2.4\text{ V}$ to 5.5 V . Typical values are at $T_J = 25^{\circ}\text{C}$ and $V_{IN} = 5\text{ V}$, unless otherwise noted.

PARAMETER		TEST CONDITIONS	MIN	TYP	MAX	UNIT
SUPPLY						
I_Q	Quiescent current into the VIN	EN = High, no load, device not switching		4	10	μA
I_{SD}	Shutdown current into the VIN	EN = Low, $T_J = -40^{\circ}\text{C}$ to 85°C		0.05	0.5	μA
I_Q	Quiescent current	EN = High, no load, device switching, FPWM devices		8		mA
V_{UVLO}	Undervoltage lockout threshold	V_{IN} falling	2.1	2.2	2.3	V
	Undervoltage lockout hysteresis	V_{IN} rising		160		mV
T_{JSD}	Thermal shutdown threshold	T_J rising		150		$^{\circ}\text{C}$
	Thermal shutdown hysteresis	T_J falling		20		$^{\circ}\text{C}$
LOGIC INTERFACE EN						
V_{IH}	High-level input voltage		1.0			V
V_{IL}	Low-level input voltage				0.4	V
$I_{kg(EN)}$	Input leakage current into EN pin	EN = High		0.01	0.1	μA
SOFT START, POWER GOOD						
t_{SS}	Soft-start time	Time from EN high to 95% of V_{OUT} nominal		1.25		ms
V_{PGTH}	Power-good lower threshold	V_{PG} rising, V_{FB} referenced to V_{FB} nominal	94%	96%	98%	
		V_{PG} falling, V_{FB} referenced to V_{FB} nominal	90%	92%	94%	
	Power-good upper threshold	V_{PG} falling, V_{FB} referenced to V_{FB} nominal	103%	105%	107%	
		V_{PG} rising, V_{FB} referenced to V_{FB} nominal	108%	110%	112%	
$V_{PG,OL}$	Low-level output voltage	$I_{sink} = 1\text{ mA}$			0.4	V
$I_{kg(PG)}$	Input leakage current into PG pin	$V_{PG} = 5\text{ V}$		0.01	0.1	μA
OUTPUT						
V_{OUT}	Output voltage accuracy	TPSM828211, TPSM828221, PWM mode	1.188	1.2	1.212	V
		TPSM828212, TPSM828222, PWM mode	1.782	1.8	1.818	
		TPSM828213, TPSM828223, PWM mode	2.475	2.5	2.525	
		TPSM828214, TPSM828224, PWM mode	3.267	3.3	3.333	
V_{FB}	Feedback regulation voltage	PWM mode	594	600	606	mV
$I_{kg(FB)}$	Feedback input leakage current	$V_{FB} = 0.6\text{ V}$		0.01	0.05	μA
I_{DIS}	Output discharge current	EN = Low, $V_{SW} = 0.4\text{ V}$	75	400		mA
POWER SWITCH						
$R_{DS(on)}$	High-side FET on-resistance			26		$\text{m}\Omega$
	Low-side FET on-resistance			26		$\text{m}\Omega$
R_{DP}	Dropout resistance	TPSM82821, TPSM82821A, 100% mode. $V_{IN} = 2.7\text{ V}$, $T_J = 25^{\circ}\text{C}$		115	145	$\text{m}\Omega$
		TPSM82822, TPSM82822A, 100% mode. $V_{IN} = 2.7\text{ V}$, $T_J = 25^{\circ}\text{C}$		90	120	
		TPSM82823, TPSM82823A, 100% mode. $V_{IN} = 2.7\text{ V}$, $T_J = 25^{\circ}\text{C}$		70	95	
I_{LIMF}	High-side FET switch current limit	TPSM82821A	1.7	2.1	2.4	A
I_{LIMF}	High-side FET switch current limit	TPSM82821	1.75	2.2	2.75	A
		TPSM82822, TPSM82822A	2.7	3.3	3.9	
		TPSM82823, TPSM82823A	3.7	4.3	5.0	
I_{LIM}	Low-side FET negative current limit, DC	TPSM82821A/TPSM82822A/TPSM82823A		-1.6		A
f_{SW}	PWM switching frequency	$I_{OUT} = 1\text{ A}$		4		MHz

7.6 Typical Characteristics

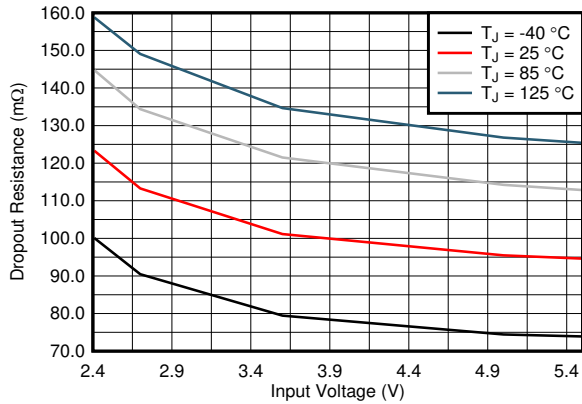

Figure 7-1. TPSM82821/TPSM82821A Dropout Resistance

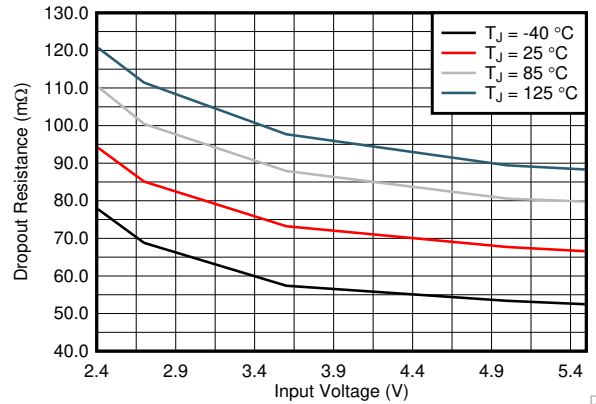

Figure 7-2. TPSM82822/TPSM82822A Dropout Resistance

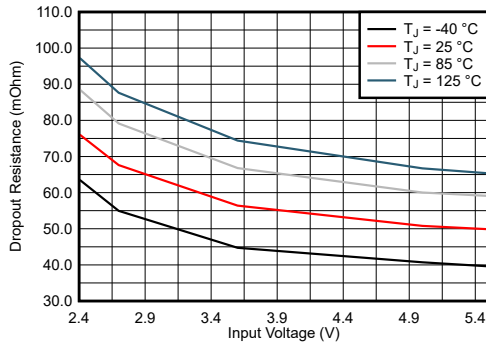

Figure 7-3. TPSM82823/TPSM82823A Dropout Resistance

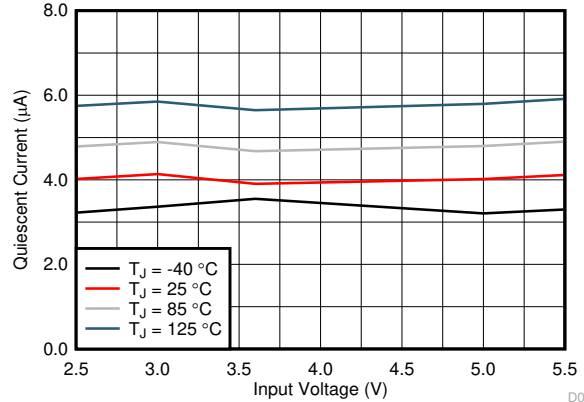

Figure 7-4. Quiescent Current

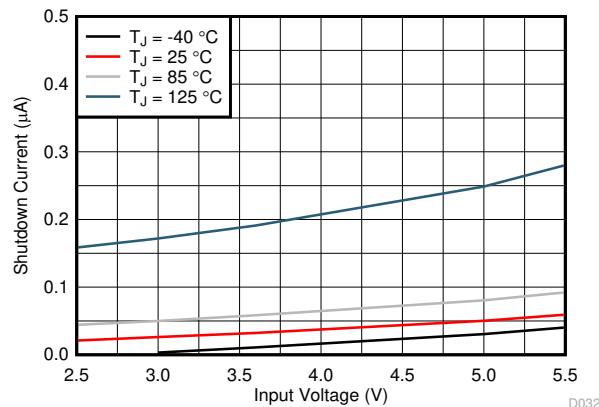

Figure 7-5. Shutdown Current

8 Detailed Description

8.1 Overview

The TPSM8282x synchronous step-down converter power module is based on DCS-Control (Direct Control with Seamless transition into power save mode). This is an advanced regulation topology that combines the advantages of hysteretic, voltage, and current mode control.

The DCS-Control topology operates in PWM (pulse width modulation) mode for medium to heavy load conditions and in PSM (power save mode) at light load currents. In PWM, the converter operates with its nominal switching frequency of 4 MHz, having a controlled frequency variation over the input voltage range. As the load current decreases, the converter enters power save mode, reducing the switching frequency and minimizing the quiescent current of the IC to achieve high efficiency over the entire load current range. DCS-Control supports both operation modes using a single building block and, therefore, has a seamless transition from PWM to PSM without effects on the output voltage.

The forced PWM versions of this device, the TPSM8282xA, does not enter PSM (power save mode) at light load currents and stays in CCM (continuous conduction mode) regardless of the output current in order to minimize the output ripple.

The TPSM8282x offers excellent DC voltage regulation and load transient regulation, combined with low output voltage ripple, minimizing interference with RF circuits.

8.2 Functional Block Diagram

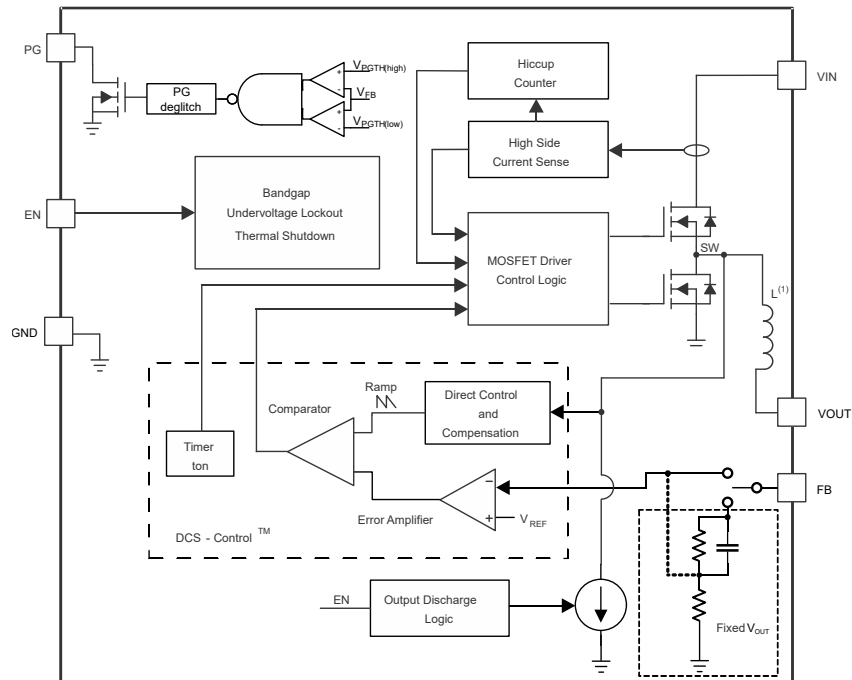

(1) Inductance value is 0.47 μH in TPSM82821/TPSM82821A, 0.24 μH in TPSM82822/TPSM82822A and 0.24 μH in TPSM82823/TPSM82823A.

8.3 Feature Description

8.3.1 PWM and PSM Operation

The TPSM8282x includes a fixed on-time (t_{ON}) circuitry. This t_{ON} , in steady-state operation in PWM and PSM modes, is estimated as:

$$t_{ON} = 250\text{ns} \times \frac{V_{OUT}}{V_{IN}} \quad (1)$$

In PWM mode, the TPSM8282x operates with pulse width modulation in continuous conduction mode (CCM) with a t_{ON} shown in Equation 1 at medium and heavy load currents. A PWM switching frequency of typically 4 MHz is achieved by this t_{ON} circuitry.

To maintain high efficiency at light loads, the device enters power save mode seamlessly when the load current decreases. This happens when the load current becomes smaller than half the ripple current of the inductor. The output current at which this occurs can be approximated with the following equation:

$$I_{OUT(\text{PSM-entry})} = \frac{V_{IN} \times t_{ON}}{2} \times \frac{1 - \frac{V_{OUT}}{V_{IN}}}{L} \quad (2)$$

In PSM, the converter operates with a reduced switching frequency and with a minimum quiescent current to maintain high efficiency. The on time in PSM is also based on the same t_{ON} circuitry. The switching frequency in PSM is estimated as:

$$f_{\text{PSM}} = \frac{2 \times I_{OUT}}{t_{ON}^2 \times \frac{V_{IN}}{V_{OUT}} \times \frac{V_{IN} - V_{OUT}}{L}} \quad (3)$$

In PSM, the output voltage rises slightly above the nominal output voltage in PWM mode. This effect is reduced by increasing the output capacitance.

The forced PWM version of this device, the TPSM8282xA, does not enter PSM (power save mode) at light load currents and stays in CCM (continuous conduction mode) regardless of the output current in order to minimize the output ripple.

8.3.2 Low Dropout Operation (100% Duty Cycle)

The device offers a low input-to-output voltage differential by entering 100% duty cycle mode. In this mode, the high-side MOSFET switch is constantly turned on. This is particularly useful in battery-powered applications to achieve longest operation time by taking full advantage of the whole battery voltage range. The minimum input voltage to maintain a minimum output voltage is given by:

$$V_{IN(\text{min})} = V_{OUT(\text{min})} + I_{OUT} \times R_{DP} \quad (4)$$

where

- R_{DP} = Resistance from V_{IN} to V_{OUT} , which includes the high-side MOSFET on-resistance and DC resistance of the inductor
- $V_{OUT(\text{min})}$ = Minimum output voltage the load can accept

8.3.3 Soft Start-up

After enabling the device, there is a 250- μ s delay before switching starts. Then, an internal soft start-up circuitry ramps up the output voltage which reaches nominal output voltage during the start-up time of 1 ms. This avoids excessive inrush current and creates a smooth output voltage rise slope. It also prevents excessive voltage drops of primary cells and rechargeable batteries with high internal impedance.

The device is able to start into a pre-biased output capacitor. It starts with the applied bias voltage and ramps the output voltage to its nominal value.

8.3.4 Switch Current Limit and Hiccup Short Circuit Protection

The switch current limit prevents the device from high inductor current and from drawing excessive current from the battery or input voltage rail. Excessive current can occur with a shorted or saturated inductor or a heavy load or shorted output circuit condition. If the inductor current reaches the threshold of I_{LIMF} , the high-side MOSFET is turned off and the low-side MOSFET remains off while the inductor current flows through its body diode and quickly ramps down.

When this switch current limit is triggered 32 times, the device stops switching. The device then automatically starts a new start-up after a typical delay time of 128 μ s has passed. This is named HICCUP short-circuit protection. The device repeats this mode until the high load condition disappears.

8.3.5 Undervoltage Lockout

To avoid mis-operation of the device at low input voltages, undervoltage lockout is implemented that shuts down the device at voltages lower than V_{UVLO} .

8.3.6 Thermal Shutdown

The device goes into thermal shutdown and stops the power stage switching when the junction temperature exceeds T_{JSD} . When the device temperature falls below the threshold by 20°C, the device returns to normal operation automatically by switching the power stage again.

8.4 Device Functional Modes

8.4.1 Enable and Disable

The device is enabled by setting the EN pin to a logic high. Accordingly, shutdown mode is forced if the EN pin is pulled low with a shutdown current of typically 50 nA. In shutdown mode, the internal power switches and the entire control circuitry are turned off. An internal switch smoothly discharges the output through the VOUT pin in shutdown mode. Do not leave the EN pin floating.

The typical threshold value of the EN pin is 0.89 V for rising input signal, and 0.62 V for falling input signal.

8.4.2 Output Discharge

The purpose of the output discharge function is to ensure a defined down-ramp of the output voltage when the device is disabled and to keep the output voltage close to 0 V. The output discharge is active when the EN pin is set to a logic low and during thermal shutdown. The discharge is not active in UVLO.

8.4.3 Power Good Output

The device has a power good output. The PG pin goes high impedance once the FB pin voltage is above 96% and less than 105% of the nominal voltage, and is driven low once the voltage falls below typically 92% or higher than 110% of the nominal voltage. Table 8-1 shows the typical PG pin logic. The PG pin is an open-drain output and is specified to sink up to 1 mA. The power good output requires a pullup resistor connecting to any voltage rail less than 5.5 V. The PG signal can be used for sequencing of multiple rails by connecting to the EN pin of other converters. If not used, the PG pin can be left floating or connected to GND.

Table 8-1. Power Good Pin Logic

DEVICE STATE		PG LOGIC STATUS	
		HIGH IMPEDANCE	LOW
Enabled (EN = High)	$0.576 \text{ V} \leq V_{\text{FB}} \leq 0.63 \text{ V}$	√	
	$V_{\text{FB}} < 0.552 \text{ V}$ or $V_{\text{FB}} > 0.66 \text{ V}$		√
Shutdown (EN = Low)			√
UVLO	$0.7 \text{ V} \leq V_{\text{IN}} < V_{\text{UVLO}}$		√
Thermal Shutdown	$T_{\text{J}} > T_{\text{JSD}}$		√
Power Supply Removal	$V_{\text{IN}} < 0.7 \text{ V}$	√	

The PG pin has a 20-μs de-glitch time on the falling edge and a 100-μs delay before PG goes high. See Figure 8-1.

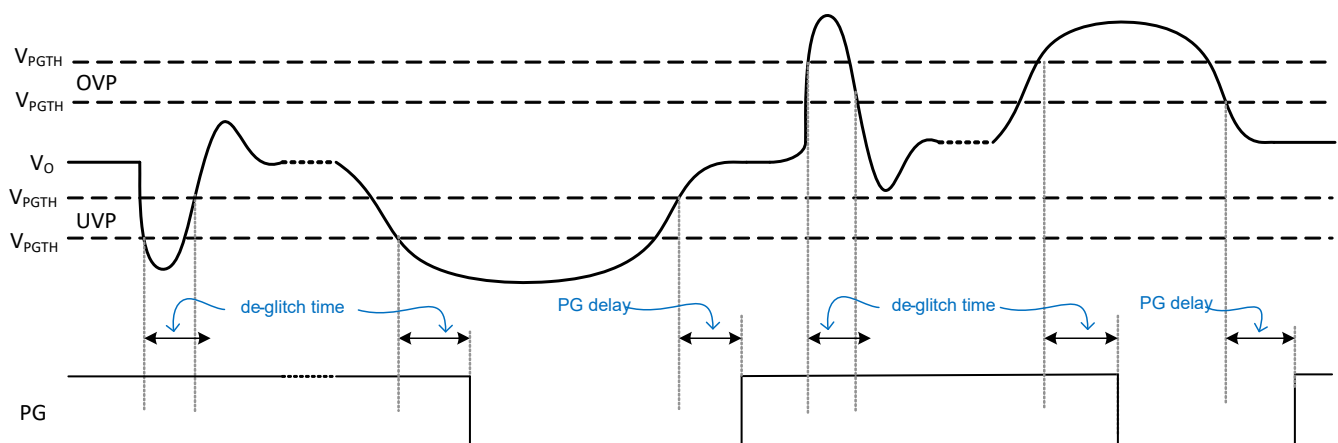

Figure 8-1. Power Good Transient and De-glitch Behavior

9 Application and Implementation

Note

Information in the following applications sections is not part of the TI component specification, and TI does not warrant its accuracy or completeness. TI's customers are responsible for determining suitability of components for their purposes, as well as validating and testing their design implementation to confirm system functionality.

9.1 Application Information

The TPSM8282x is a synchronous step-down converter power module. The required power inductor is integrated inside the TPSM8282x. The inductance value is 0.47 μH for the TPSM82821 and TPS82821A, 0.24 μH for the TPSM82822, TPSM82822A, TPSM82823 and TPSM82823A with a $\pm 20\%$ tolerance. The TPSM82821/TPSM82821A, TPSM82822/TPSM82822A and TPSM82823/TPSM82823A are pin-to-pin and BOM-to-BOM compatible with each other.

9.2 Typical Applications

9.2.1 1.8-V Output Application

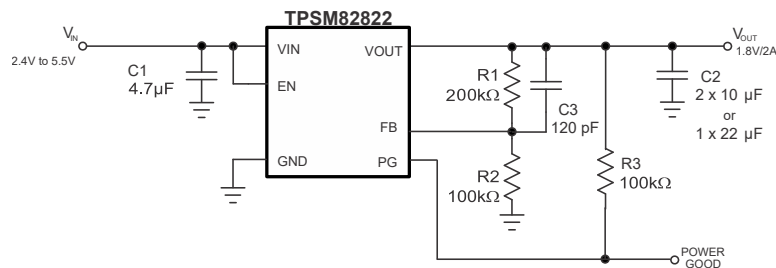

Figure 9-1. Adjustable Output Application Set at 1.8-V Output Voltage

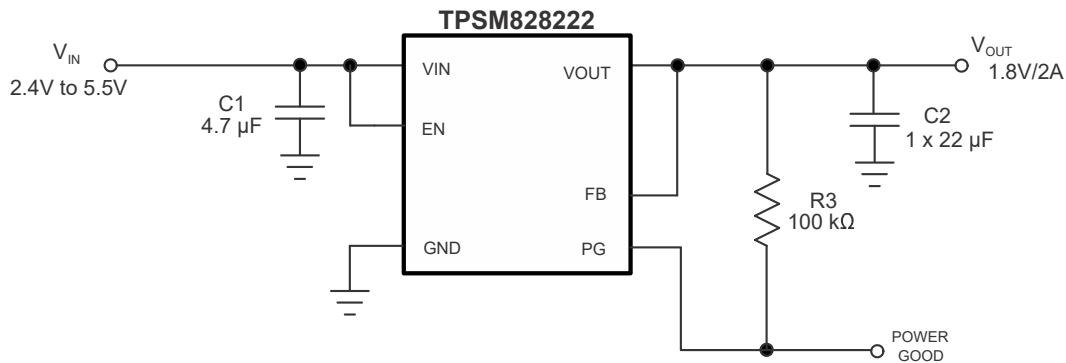

Figure 9-2. Fixed Output Application Set at 1.8-V Output Voltage

9.2.1.1 Design Requirements

The design guidelines provide a component selection to operate the device within the recommended operating conditions.

Table 9-1 lists the components used for Figure 9-1. Table 9-2 lists the components used for Figure 9-2.

Table 9-1. List of Components

REFERENCE	DESCRIPTION	MANUFACTURER
C1	Ceramic capacitor, 4.7 μ F, 6.3 V, X7R, size (0603), JMK107BB7475MA	Taiyo Yuden
C2	Ceramic capacitor, 2 \times 10 μ F, 10 V, X7R, size (0603), GRM188Z71A106MA73D	muRata
	Ceramic capacitor, 1 \times 22 μ F, 6.3 V, X6S, size (0603), JMK107BC6226MA-T	Taiyo Yuden
C3	Ceramic capacitor, 120 pF, 50 V, size (0603), 06035A121JAT2A	AVX
R1	Resistor, 200 k Ω , 1% accuracy	std
R2	Resistor, 100 k Ω , 1% accuracy	std
R3	Resistor, 100 k Ω , 1% accuracy	std

Table 9-2. List of Components

REFERENCE	DESCRIPTION	MANUFACTURER
C1	Ceramic capacitor, 4.7 μ F, 6.3 V, X7R, size (0603), JMK107BB7475MA	Taiyo Yuden
C2	Ceramic capacitor, 22 μ F, 4 V, X5R, size (0402), AMK105EBJ226MV-F	Taiyo Yuden
R3	Resistor, 100 k Ω , 1% accuracy	std

9.2.1.2 Detailed Design Procedure

9.2.1.2.1 Setting the Output Voltage

Choose resistors R1 and R2 to set the output voltage within a range of 0.6 V to 4 V according to Equation 5. To keep the feedback (FB) net robust from noise, set R2 equal to or lower than 100 k Ω to have at least 6 μ A of current in the voltage divider. Lower values of FB resistors achieve better noise immunity, and lower light load efficiency, as explained in the [Design Considerations for a Resistive Feedback Divider in a DC/DC Converter Technical Brief](#).

$$R1 = R2 \times \left(\frac{V_{OUT}}{V_{FB}} - 1 \right) = R2 \times \left(\frac{V_{OUT}}{0.6V} - 1 \right) \quad (5)$$

For devices with a fixed output voltage, the FB pin must be connected to VOUT. R1, R2 and C3 are not needed. The fixed output voltage devices have an internal feed forward capacitor.

9.2.1.2.2 Feedforward capacitor

A feedforward capacitor (C3) is required in parallel with R1. Equation 6 calculates the C3 value. For the recommended 100-k Ω value for R2, a 120-pF feedforward capacitor is used.

$$C3 = \frac{12\mu s}{R2} \quad (6)$$

9.2.1.2.3 Input and Output Capacitor Selection

For the best output and input voltage filtering, ceramic capacitors are required. The input capacitor minimizes input voltage ripple, suppresses input voltage spikes, and provides a stable system rail for the device. A 4.7- μ F or larger input capacitor is required. The output capacitor value can range from 10 μ F up to 47 μ F. The recommended typical output capacitor value is 2 \times 10- μ F or 1 \times 22- μ F with an X5R or X7R dielectric. Values over 47 μ F can degrade the loop stability of the converter. A feedforward capacitor is required for best transient performance.

Ceramic capacitors have a DC-Bias effect, which has a strong influence on the final effective capacitance. Choose the right capacitor carefully in combination with considering its package size and voltage rating. Ensure that the effective input capacitance is at least 3 μF and the effective output capacitance is at least 5 μF .

9.2.1.3 Application Performance Curves

$T_A = 25^\circ\text{C}$, $V_{IN} = 5\text{ V}$, $V_{OUT} = 1.8\text{ V}$, BOM = [Table 9-1](#) unless otherwise noted.

9.2.1.3.1 TPSM82821 Performance Curves

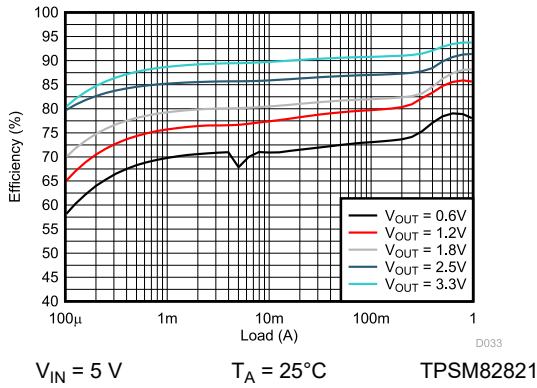

Figure 9-3. Efficiency

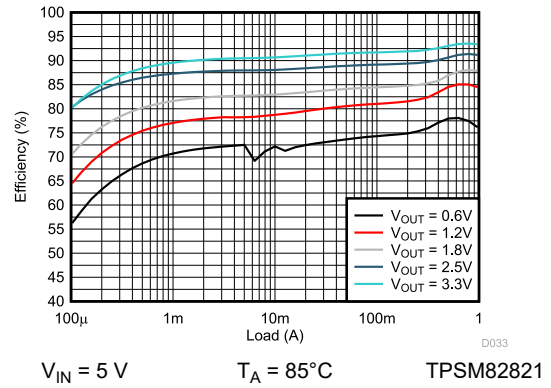

Figure 9-4. Efficiency

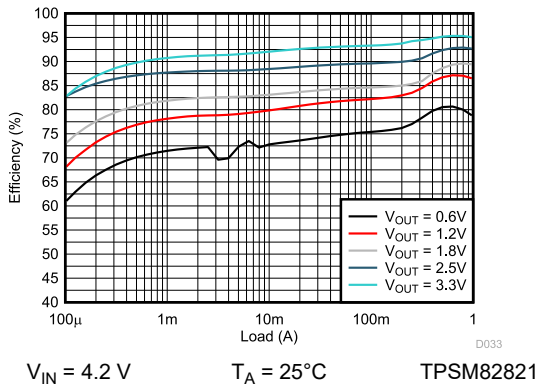

Figure 9-5. Efficiency

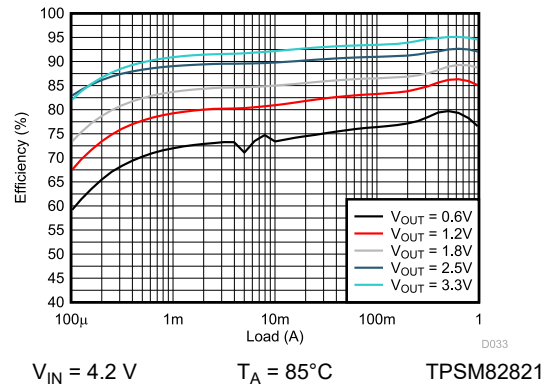

Figure 9-6. Efficiency

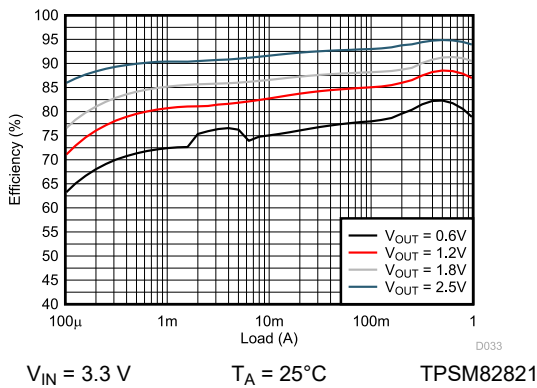

Figure 9-7. Efficiency

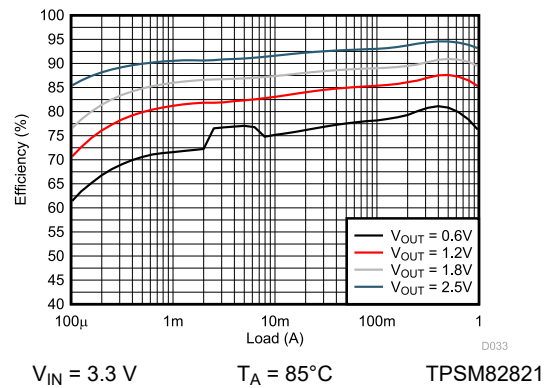

Figure 9-8. Efficiency

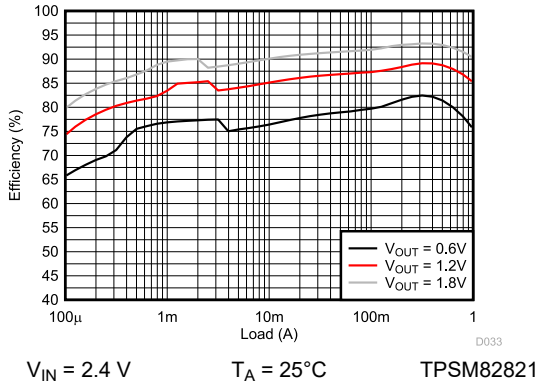

Figure 9-9. Efficiency

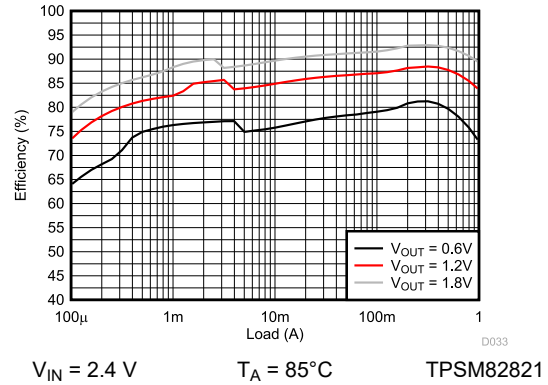

Figure 9-10. Efficiency

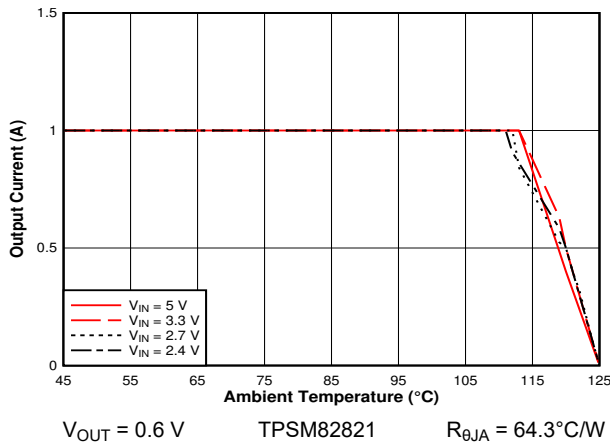

Figure 9-11. Safe Operating Area

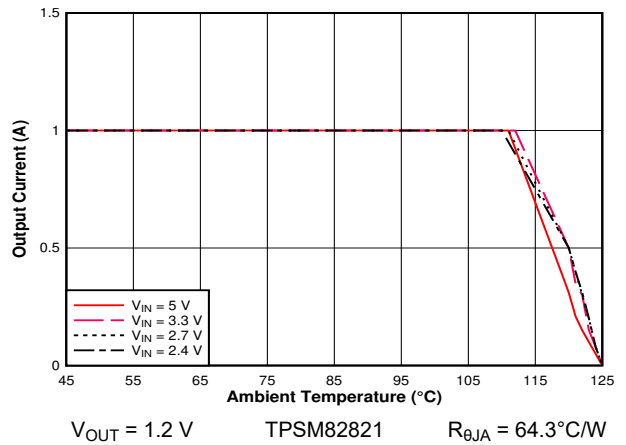

Figure 9-12. Safe Operating Area

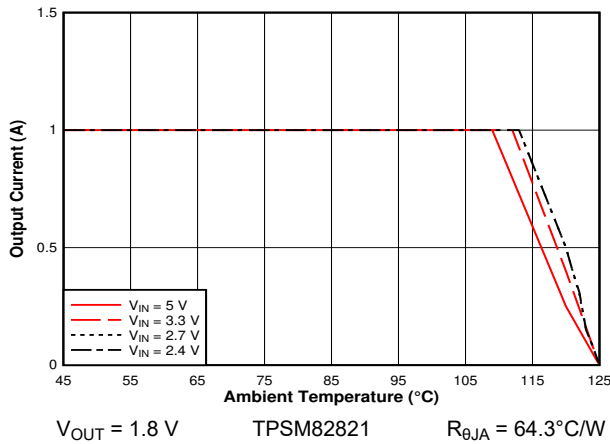

Figure 9-13. Safe Operating Area

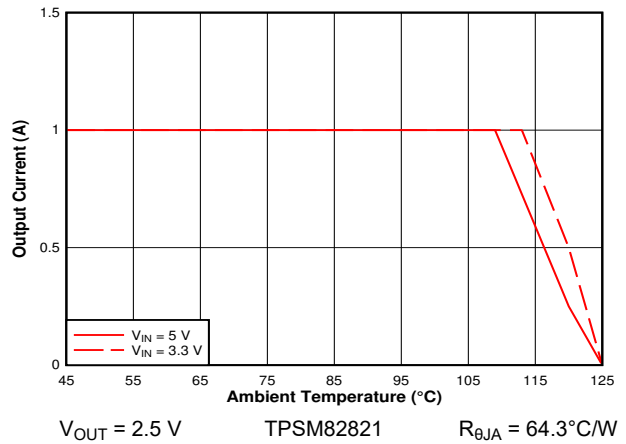
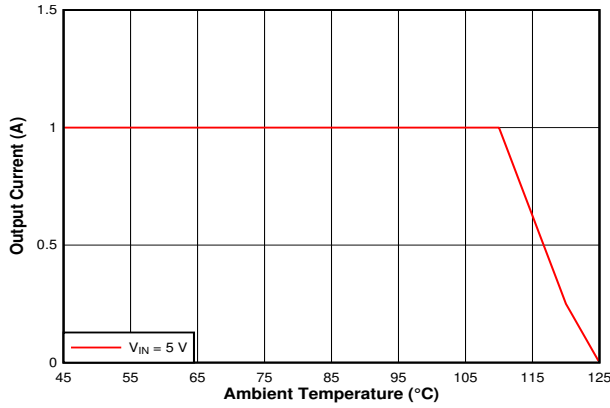
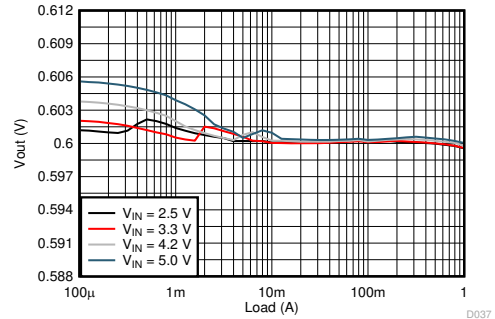

Figure 9-14. Safe Operating Area



$V_{OUT} = 3.3\text{ V}$ TPSM82821 $R_{\theta JA} = 64.3^{\circ}\text{C/W}$

Figure 9-15. Safe Operating Area



$V_{OUT} = 0.6\text{ V}$ TPSM82821

Figure 9-16. Load Regulation

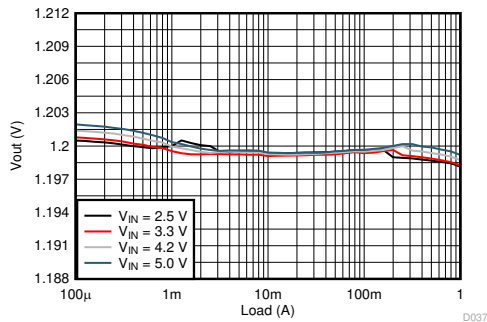

$V_{OUT} = 1.2\text{ V}$ TPSM82821

Figure 9-17. Load Regulation

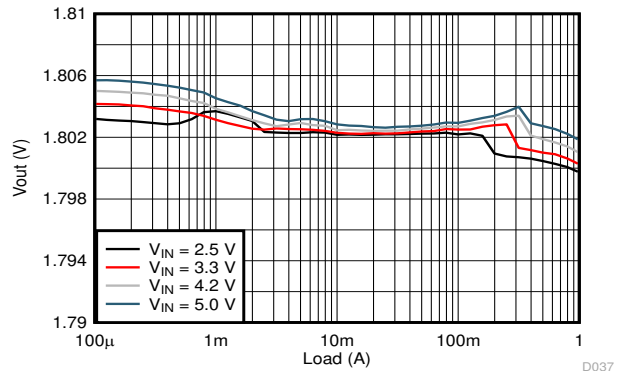

$V_{OUT} = 1.8\text{ V}$ TPSM82821

Figure 9-18. Load Regulation

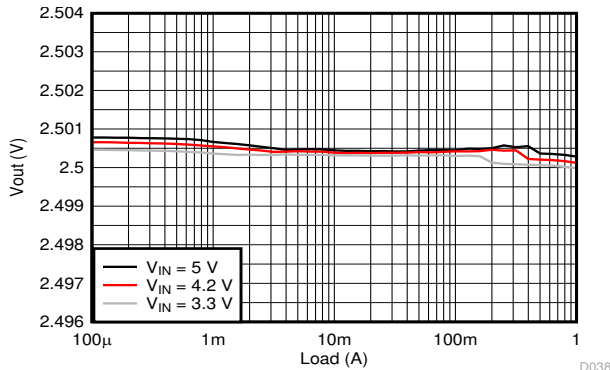

$V_{OUT} = 2.5\text{ V}$ TPSM82821

Figure 9-19. Load Regulation

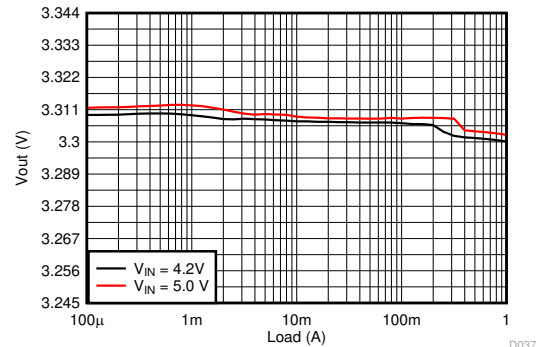

$V_{OUT} = 3.3\text{ V}$ TPSM82821

Figure 9-20. Load Regulation

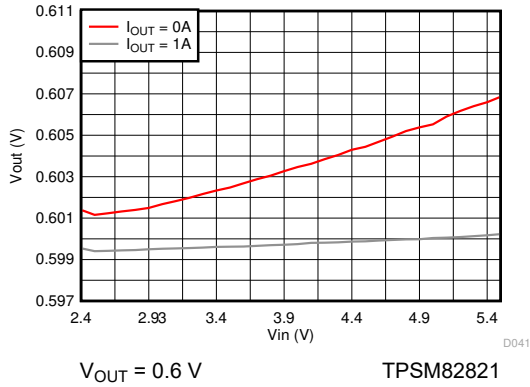

Figure 9-21. Line Regulation

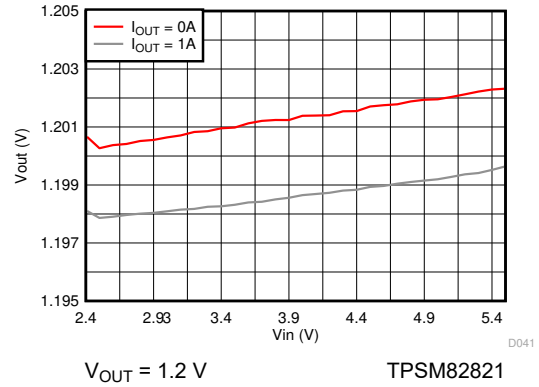

Figure 9-22. Line Regulation

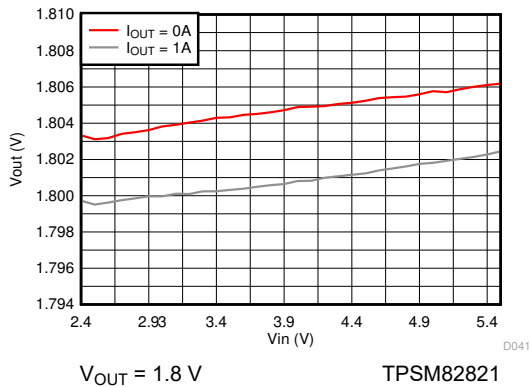

Figure 9-23. Line Regulation

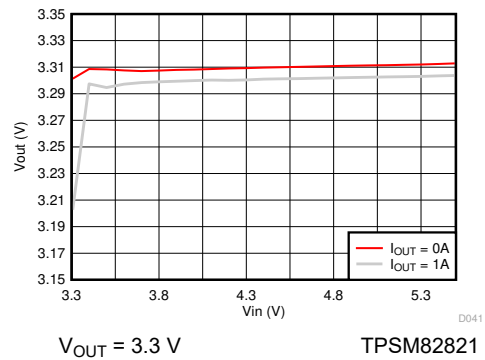

Figure 9-24. Line Regulation

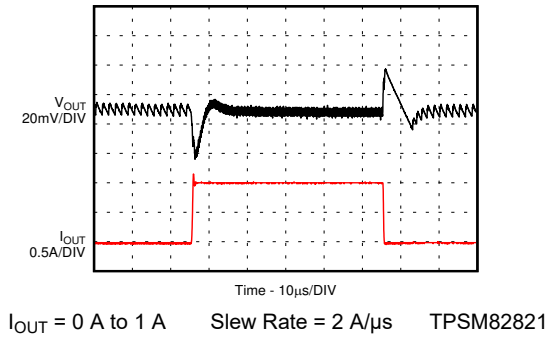

Figure 9-25. Load Transient

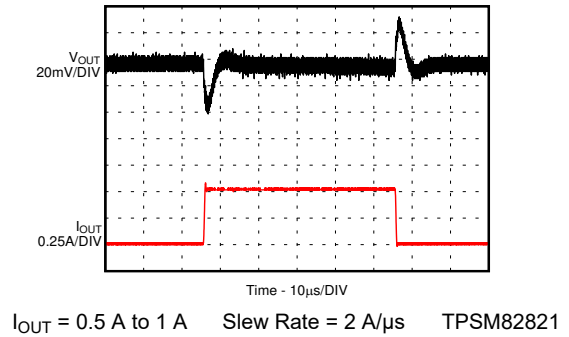
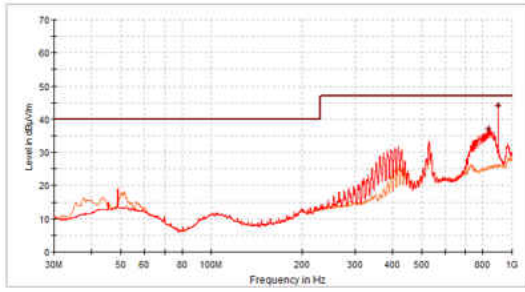

Figure 9-26. Load Transient



Horizontal - QPK
 Vertical - QPK
 CISPR 11 Group 1 Class B 3m Limit

$R_{LOAD} = 2.2 \Omega$, $V_{IN} = 5.5 \text{ V}$ (battery supply), $V_{OUT} = 1.8 \text{ V}$,
 tested on TPSM82821EVM-080

Figure 9-27. TPSM82821 Radiated Emissions

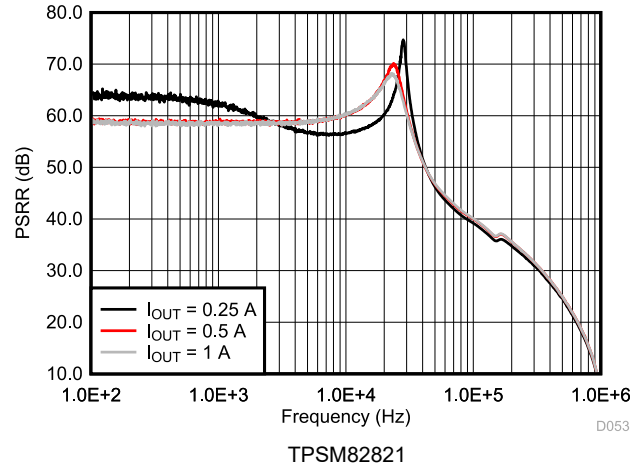

Figure 9-28. Power Supply Rejection Ratio (PSRR)

9.2.1.3.2 TPSM82821A Performance Curves

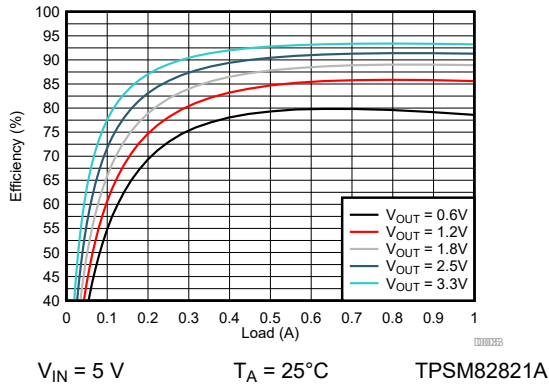

Figure 9-29. Efficiency

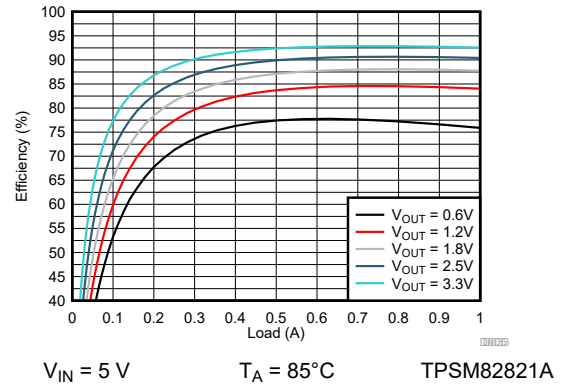

Figure 9-30. Efficiency

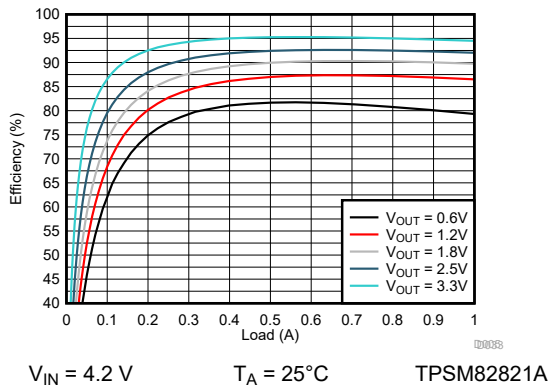

Figure 9-31. Efficiency

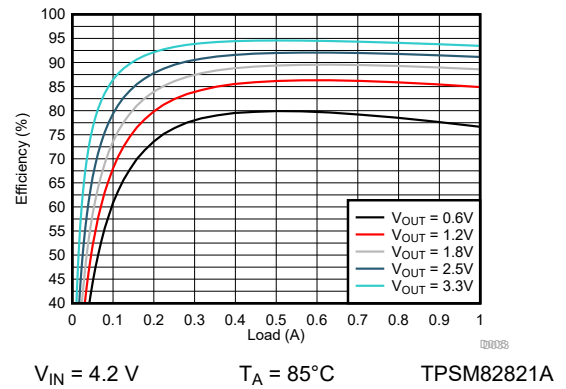

Figure 9-32. Efficiency

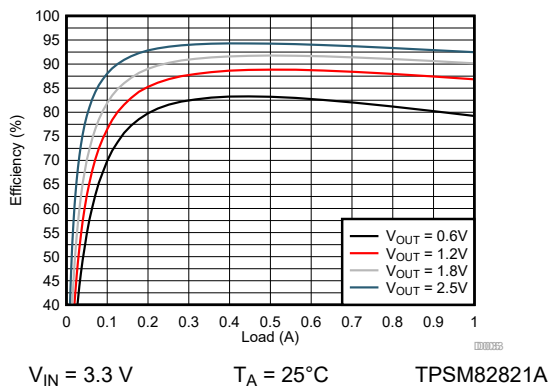

Figure 9-33. Efficiency

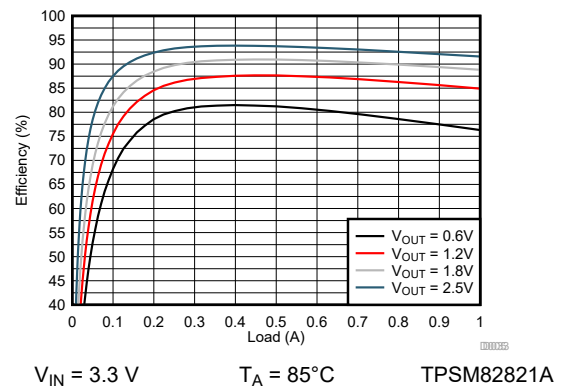
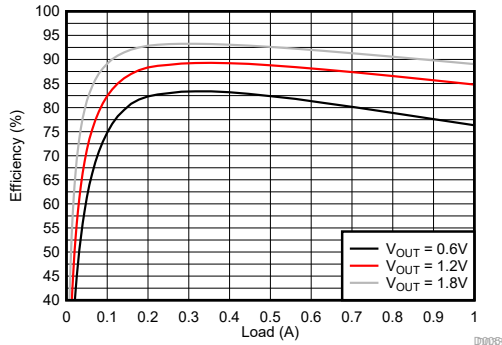
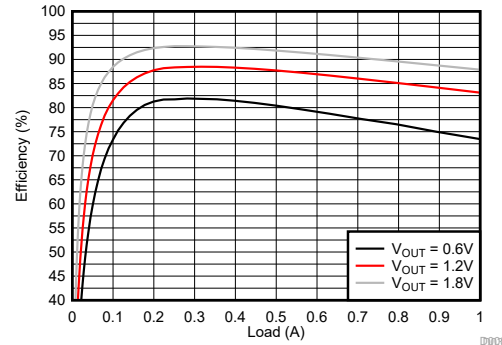

Figure 9-34. Efficiency



$V_{IN} = 2.4\text{ V}$ $T_A = 25^\circ\text{C}$ TPSM82821A

Figure 9-35. Efficiency



$V_{IN} = 2.4\text{ V}$ $T_A = 85^\circ\text{C}$ TPSM82821A

Figure 9-36. Efficiency

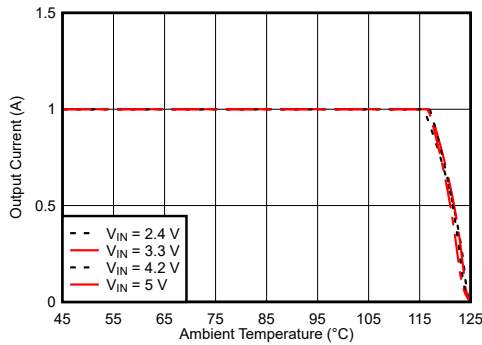

$V_{OUT} = 0.6\text{ V}$ TPSM82821A $R_{\theta JA} = 64.3^\circ\text{C/W}$

Figure 9-37. Safe Operating Area

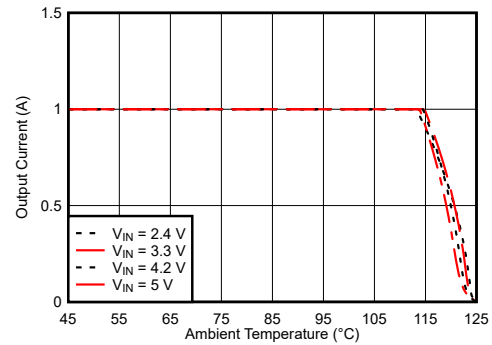

$V_{OUT} = 1.2\text{ V}$ TPSM82821A $R_{\theta JA} = 64.3^\circ\text{C/W}$

Figure 9-38. Safe Operating Area

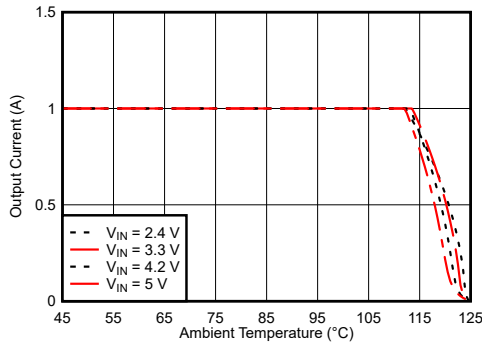

$V_{OUT} = 1.8\text{ V}$ TPSM82821A $R_{\theta JA} = 64.3^\circ\text{C/W}$

Figure 9-39. Safe Operating Area

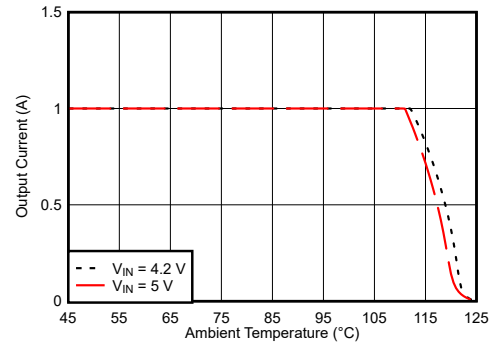

$V_{OUT} = 2.5\text{ V}$ TPSM82821A $R_{\theta JA} = 64.3^\circ\text{C/W}$

Figure 9-40. Safe Operating Area

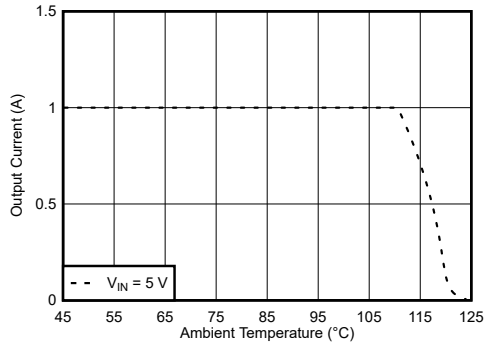

$V_{OUT} = 3.3\text{ V}$ **TPSM82821A** $R_{\theta JA} = 64.3^{\circ}\text{C/W}$

Figure 9-41. Safe Operating Area

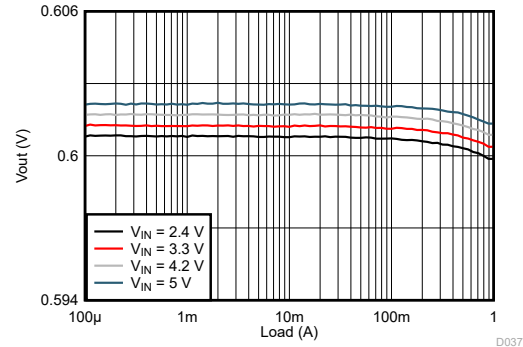

$V_{OUT} = 0.6\text{ V}$ **TPSM82821A**

Figure 9-42. Load Regulation

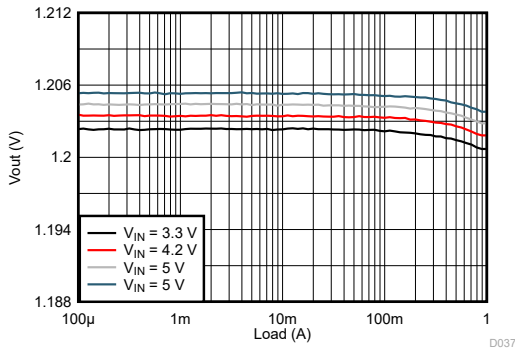

$V_{OUT} = 1.2\text{ V}$ **TPSM82821A**

Figure 9-43. Load Regulation

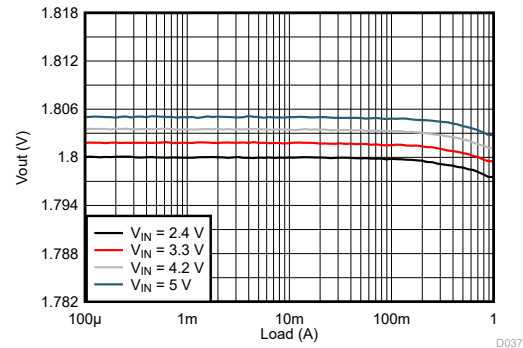

$V_{OUT} = 1.8\text{ V}$ **TPSM82821A**

Figure 9-44. Load Regulation

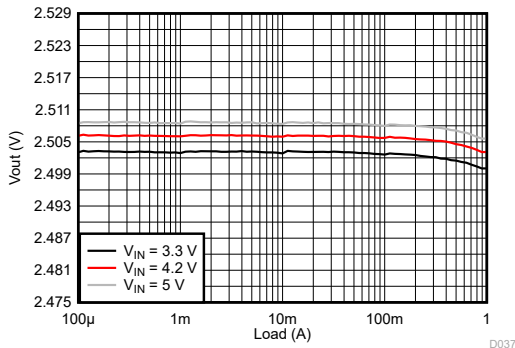

$V_{OUT} = 2.5\text{ V}$ **TPSM82821A**

Figure 9-45. Load Regulation

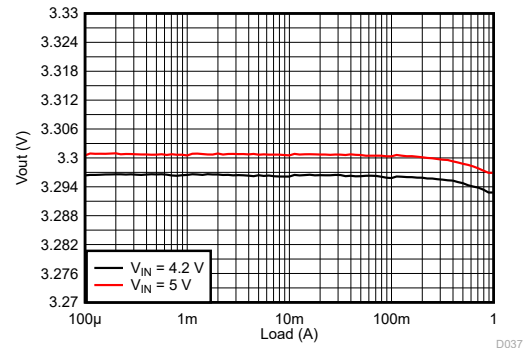

$V_{OUT} = 3.3\text{ V}$ **TPSM82821A**

Figure 9-46. Load Regulation

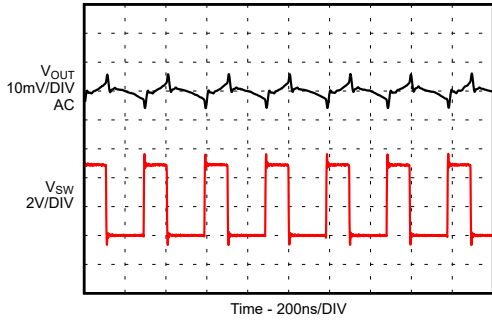

$I_{OUT} = 1\text{ A}$ TPSM82821A

Figure 9-47. Output Ripple in PWM Mode

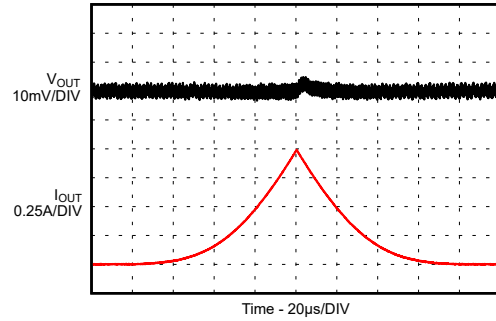

$I_{OUT} = 0\text{ mA to }1\text{ A}$ TPSM82821A

Figure 9-48. Load Sweep

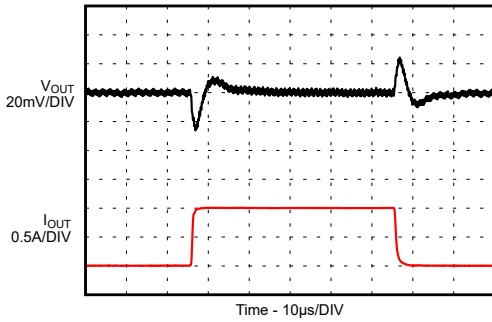

$I_{OUT} = 0\text{ A to }1\text{ A}$ Slew Rate = $2\text{ A}/\mu\text{s}$ TPSM82821A

Figure 9-49. Load Transient

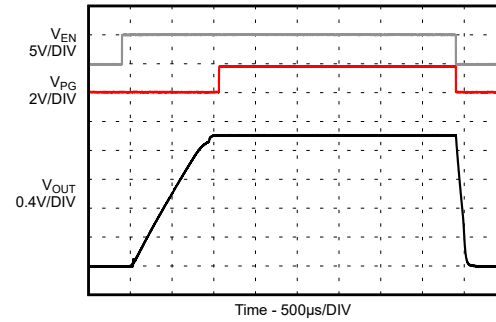

$I_{OUT} = \text{no load}$ TPSM82821A

Figure 9-50. Start-up / Shutdown without Load

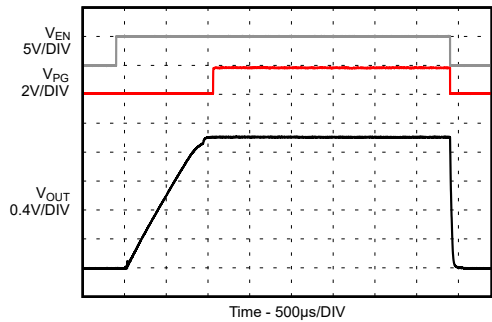

$I_{OUT} = 1\text{ A}$ TPSM82821A

Figure 9-51. Start-up / Shutdown with Resistive Load

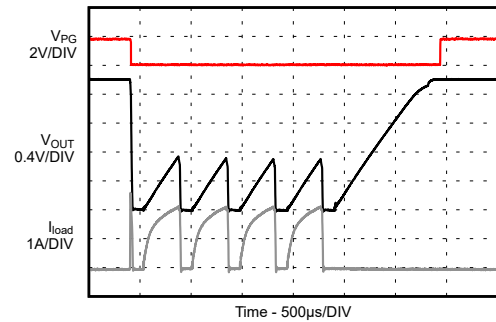

TPSM82821A

Figure 9-52. Short Circuit, HICCU Protection Entry / Exit

9.2.1.3.3 TPSM82822 Performance Curves

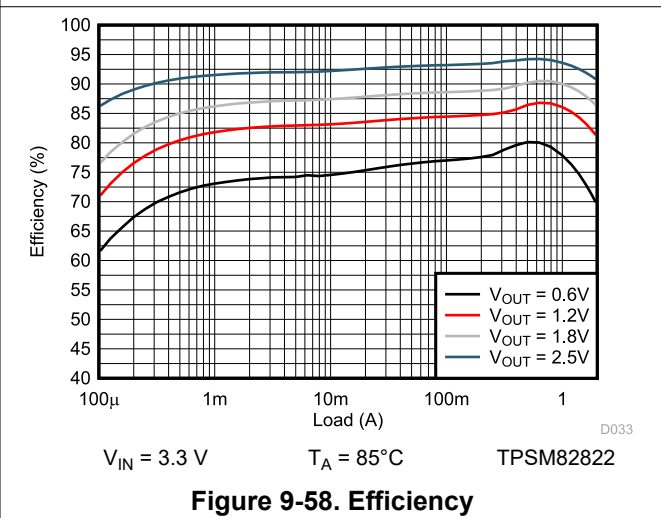
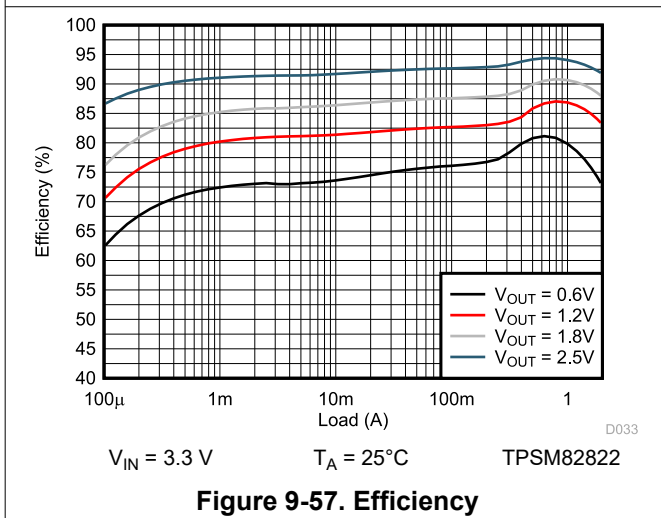
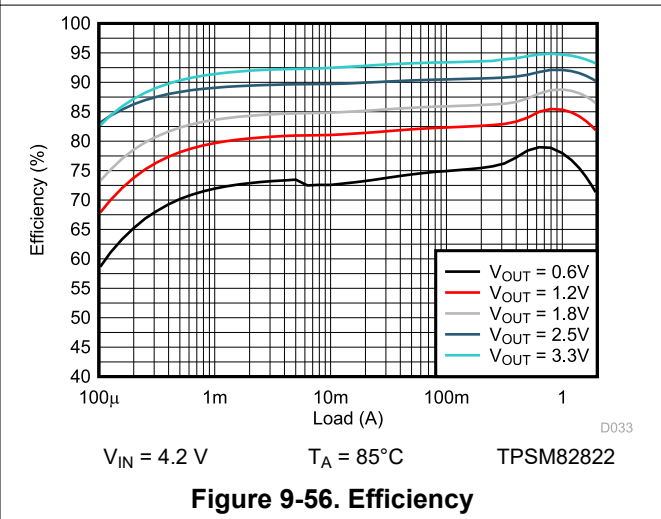
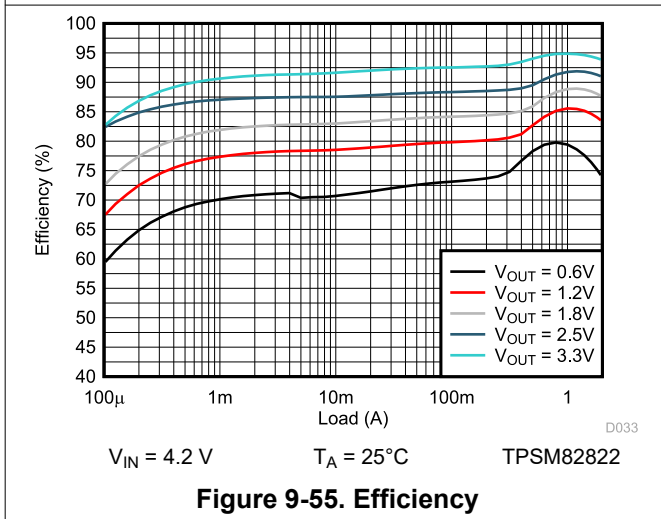
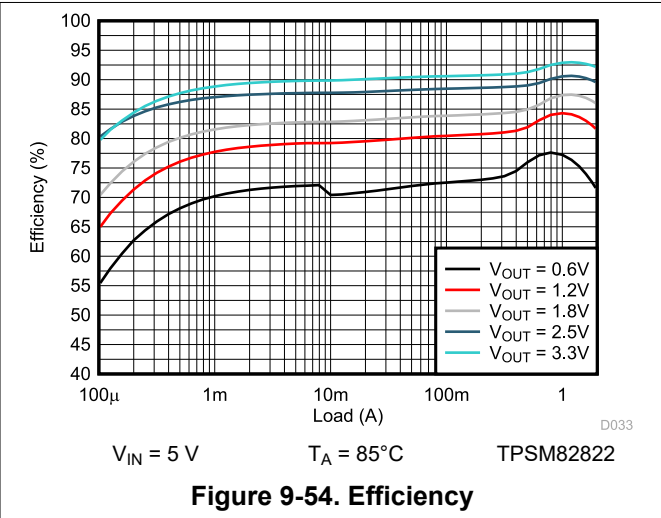
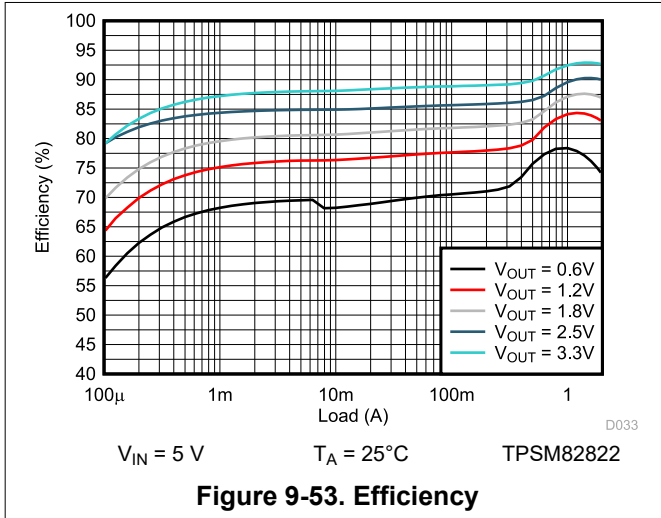

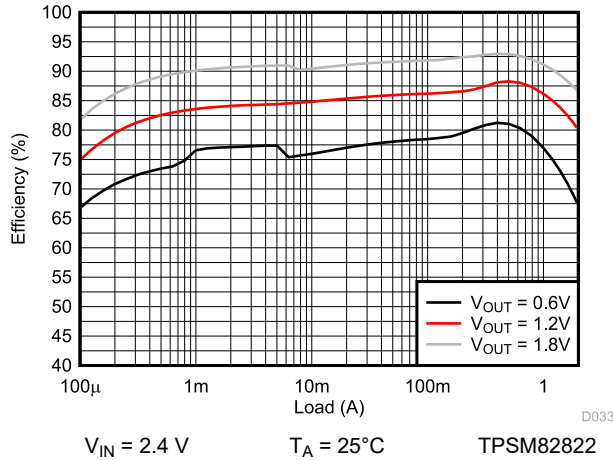

Figure 9-59. Efficiency

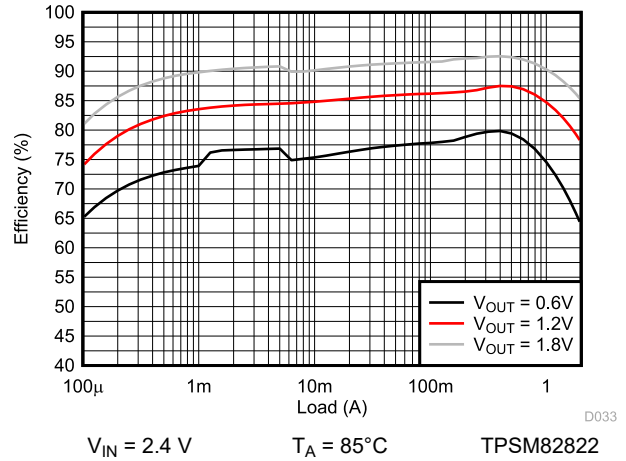

Figure 9-60. Efficiency

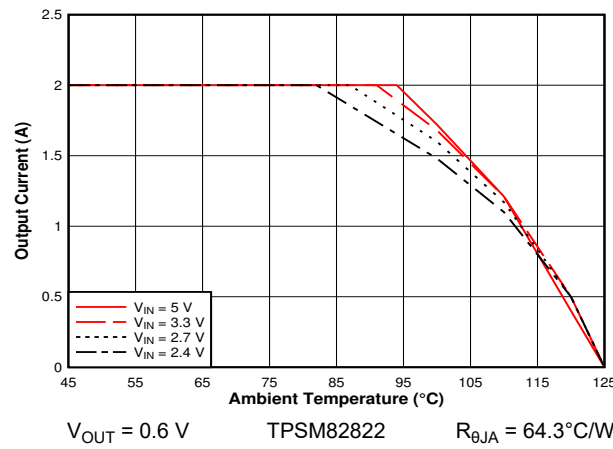

Figure 9-61. Safe Operating Area

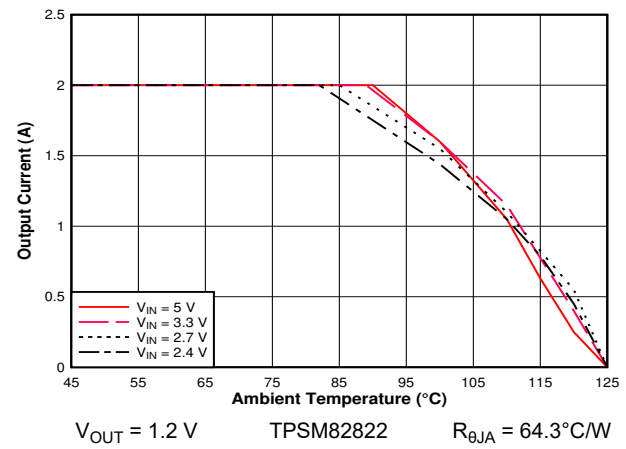

Figure 9-62. Safe Operating Area

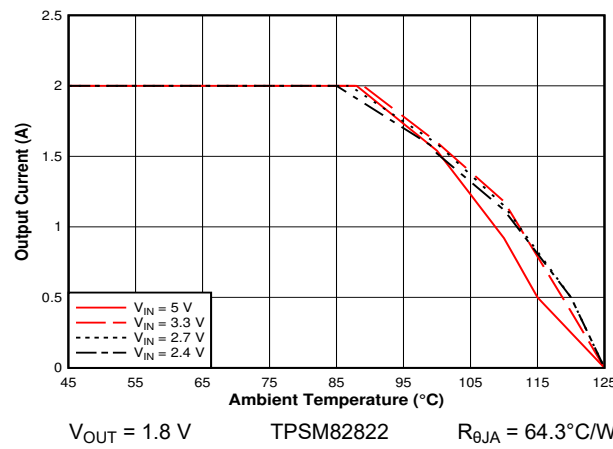

Figure 9-63. Safe Operating Area

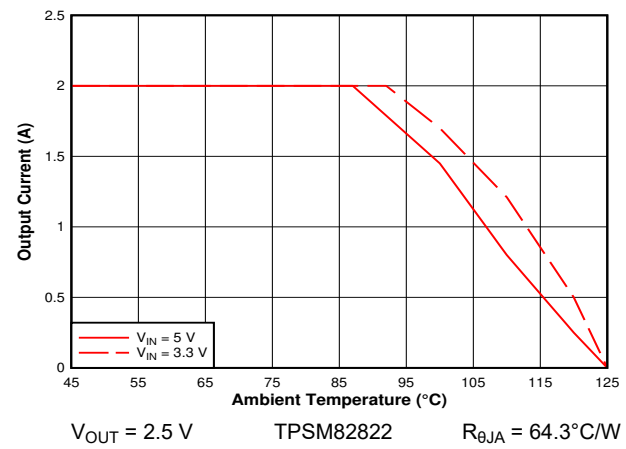
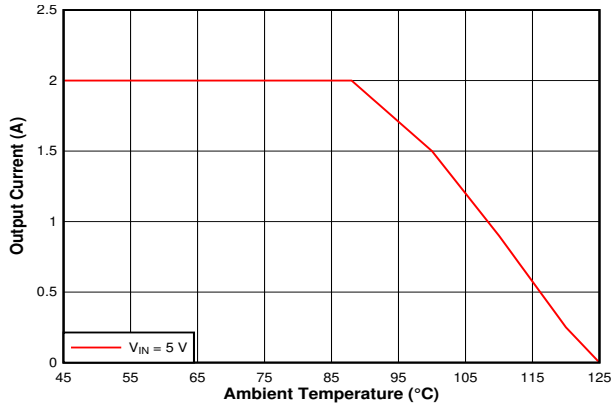
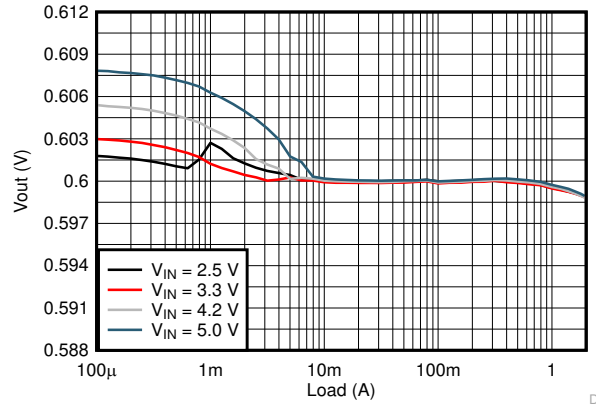

Figure 9-64. Safe Operating Area



$V_{OUT} = 3.3\text{ V}$ TPSM82822 $R_{\theta JA} = 64.3^\circ\text{C/W}$

Figure 9-65. Safe Operating Area



$V_{OUT} = 0.6\text{ V}$ TPSM82822

Figure 9-66. Load Regulation

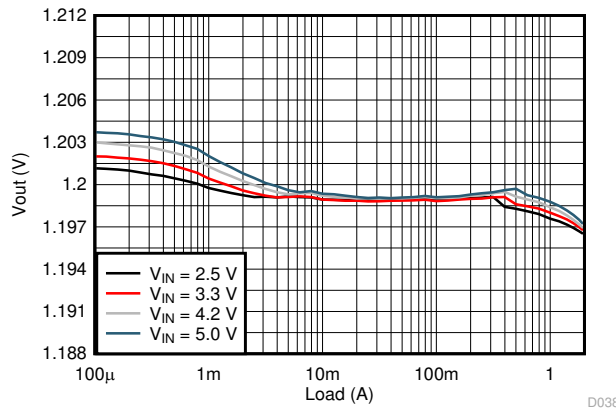

$V_{OUT} = 1.2\text{ V}$ TPSM82822

Figure 9-67. Load Regulation

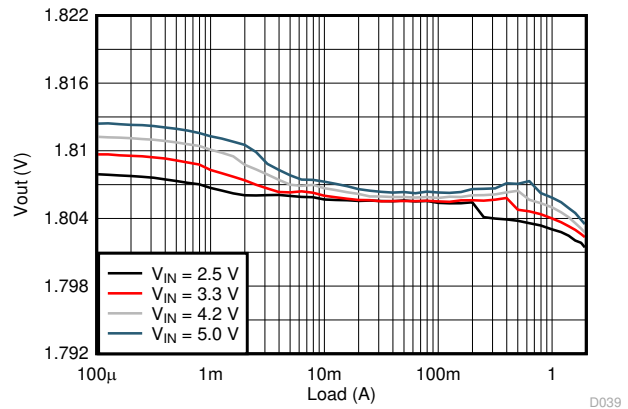

$V_{OUT} = 1.8\text{ V}$ TPSM82822

Figure 9-68. Load Regulation

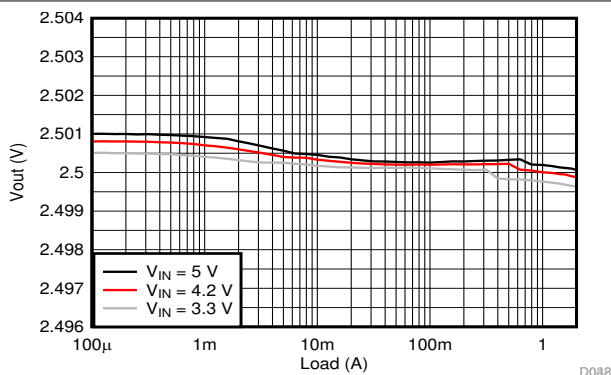

$V_{OUT} = 2.5\text{ V}$ TPSM82822

Figure 9-69. Load Regulation

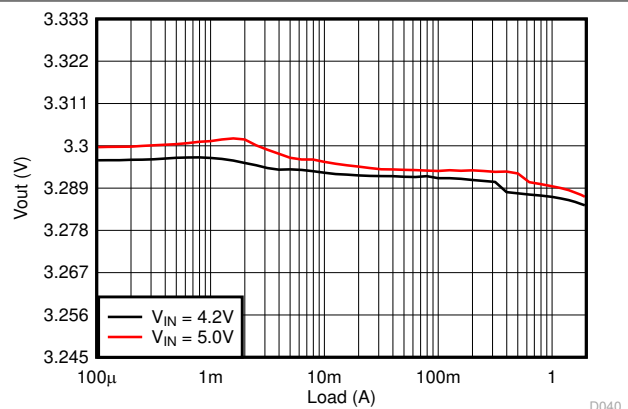

$V_{OUT} = 3.3\text{ V}$ TPSM82822

Figure 9-70. Load Regulation

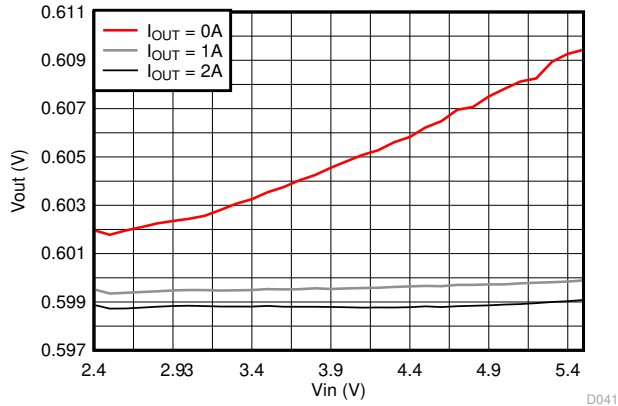

$V_{OUT} = 0.6\text{ V}$ TPSM82822

Figure 9-71. Line Regulation

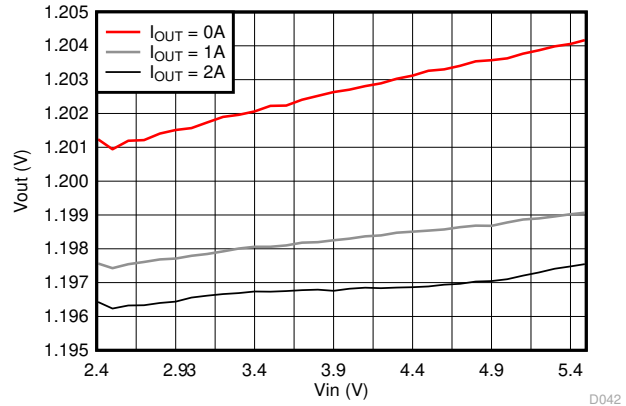

$V_{OUT} = 1.2\text{ V}$ TPSM82822

Figure 9-72. Line Regulation

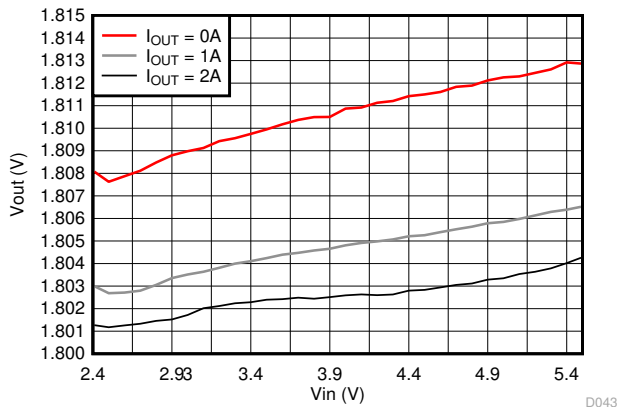

$V_{OUT} = 1.8\text{ V}$ TPSM82822

Figure 9-73. Line Regulation

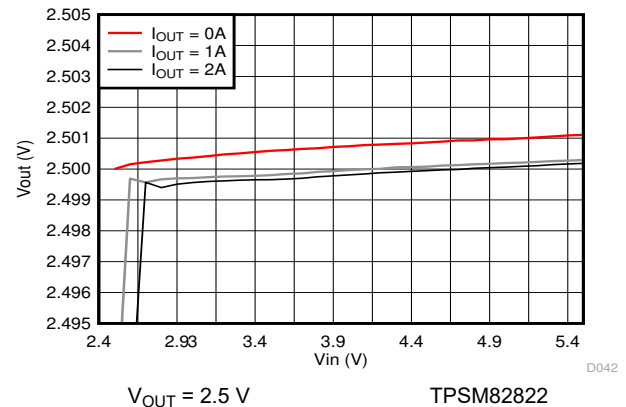

$V_{OUT} = 2.5\text{ V}$ TPSM82822

Figure 9-74. Line Regulation

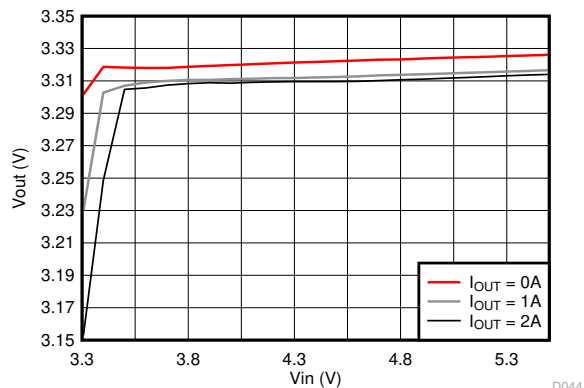

$V_{OUT} = 3.3\text{ V}$ TPSM82822

Figure 9-75. Line Regulation

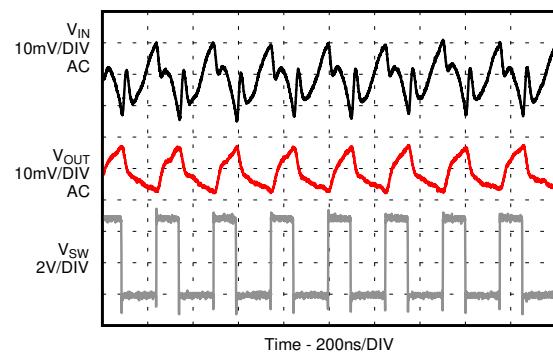

$I_{OUT} = 2\text{ A}$

TPSM82822

Figure 9-76. Input and Output Ripple in PWM Mode

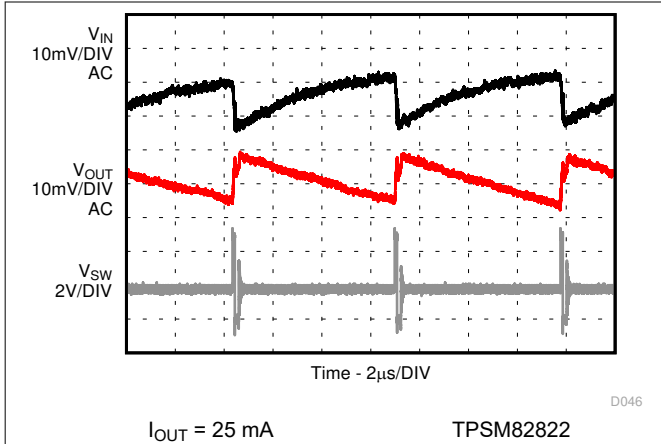

Figure 9-77. Input and Output Ripple in PSM Mode

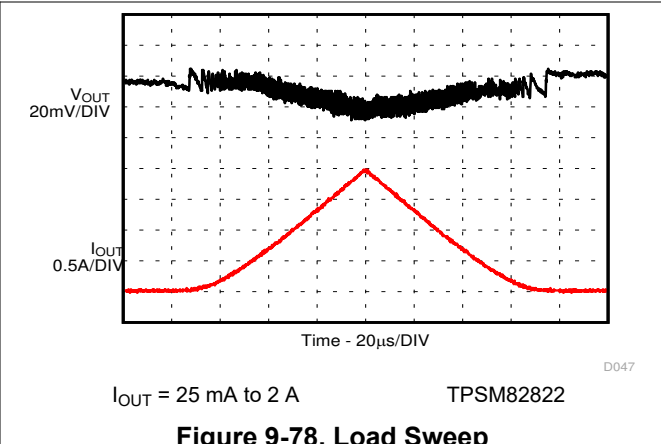

Figure 9-78. Load Sweep

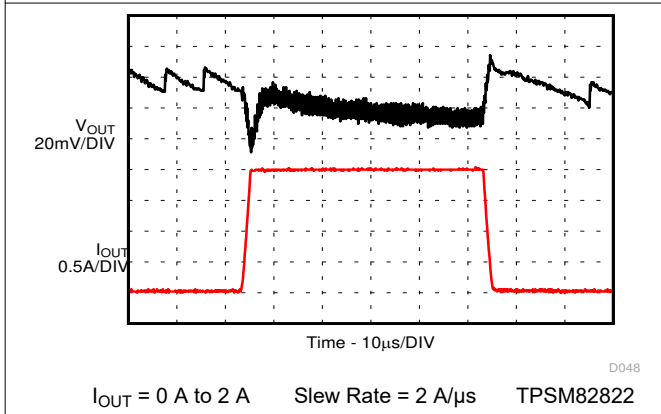

Figure 9-79. Load Transient

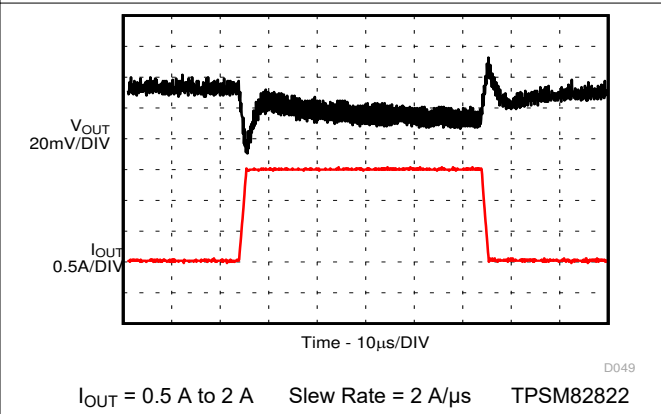

Figure 9-80. Load Transient

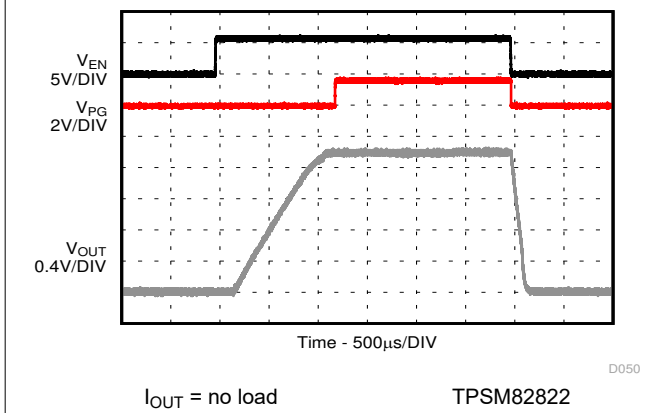

Figure 9-81. Start-up / Shutdown without Load

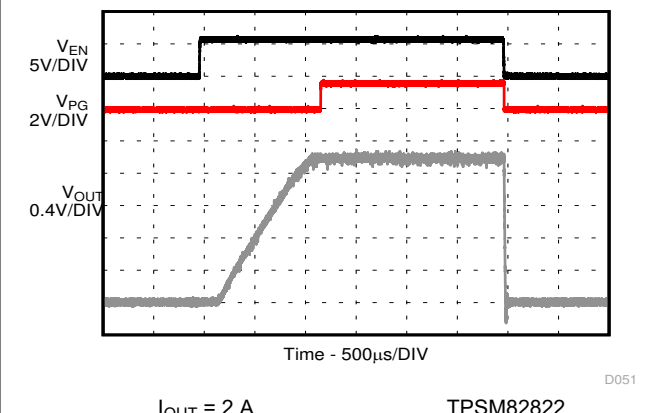
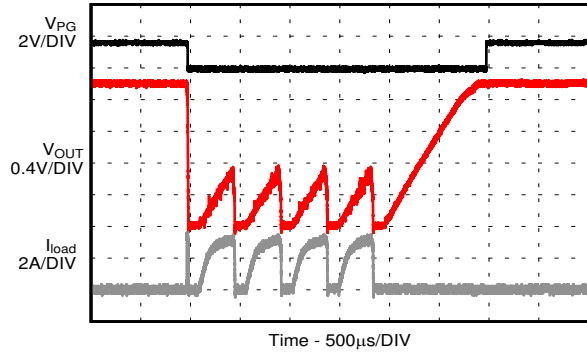

Figure 9-82. Start-up / Shutdown with Resistive Load



Time - 500µs/DIV

D052

TPSM82822

Figure 9-83. Short Circuit, HICCUP Protection Entry / Exit

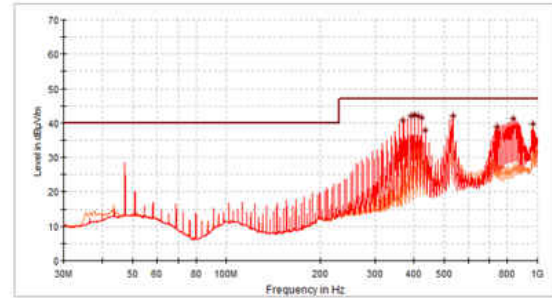

Horizontal - QPK
 Vertical - QPK
 CISPR 11 Group 1 Class B 3m Limit

$R_{LOAD} = 1 \Omega$, $V_{IN} = 5.5 \text{ V}$ (battery supply), $V_{OUT} = 1.8 \text{ V}$, tested on TPSM82822EVM-080

Figure 9-84. TPSM82822 Radiated Emissions

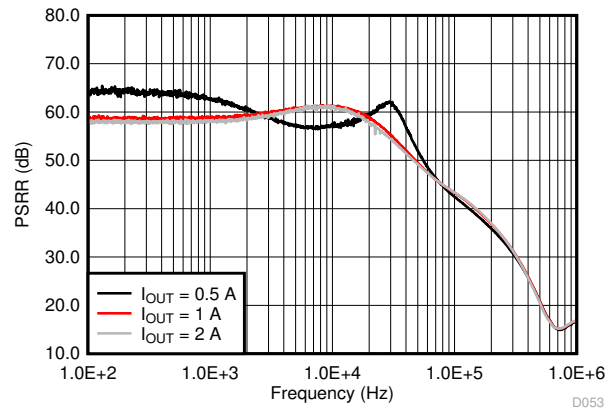

Frequency (Hz)

D053

TPSM82822

Figure 9-85. Power Supply Rejection Ratio (PSRR)

9.2.1.3.4 TPSM82822A Performance Curves

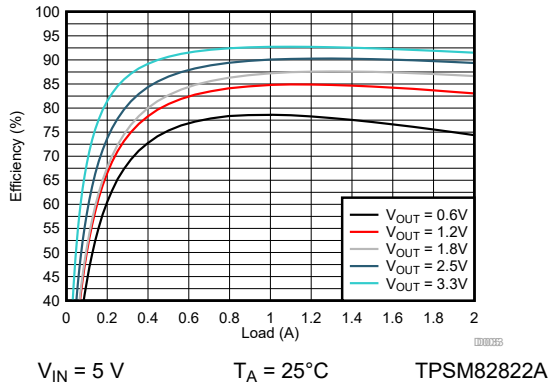

Figure 9-86. Efficiency

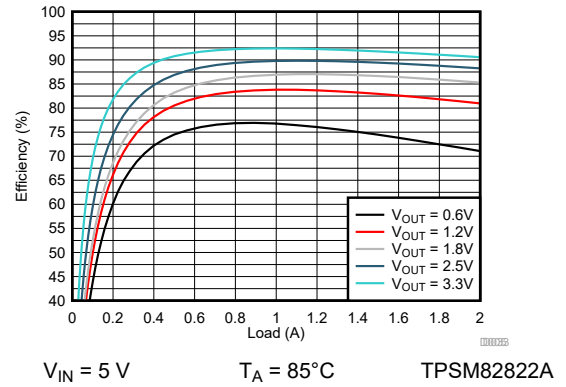

Figure 9-87. Efficiency

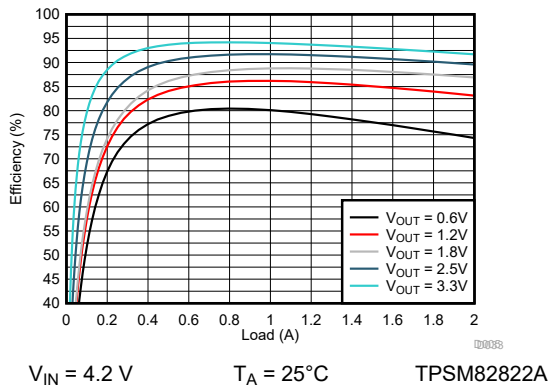

Figure 9-88. Efficiency

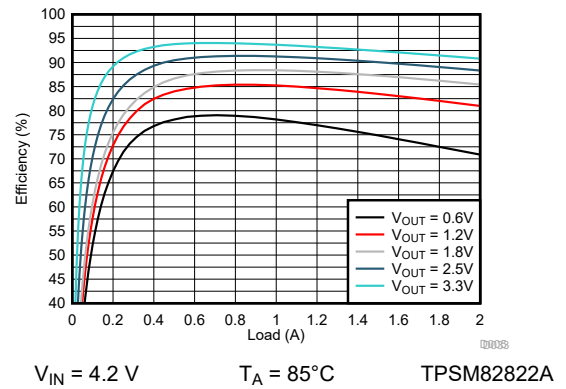

Figure 9-89. Efficiency

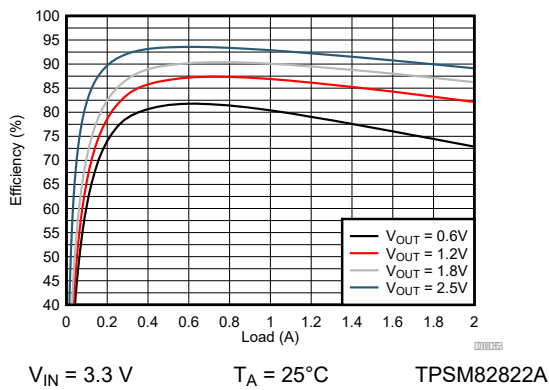

Figure 9-90. Efficiency

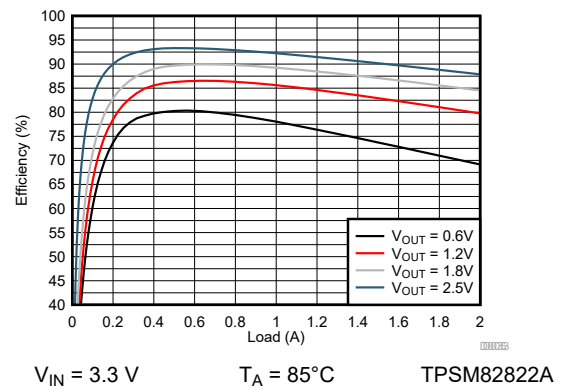

Figure 9-91. Efficiency

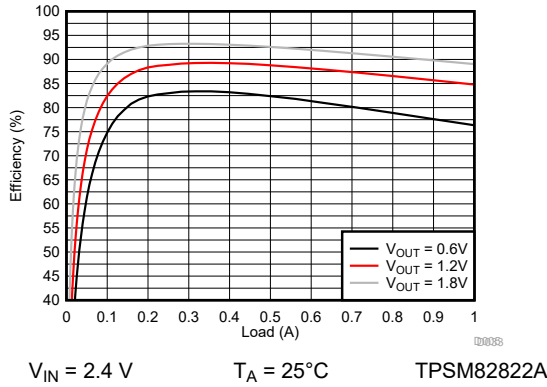

Figure 9-92. Efficiency

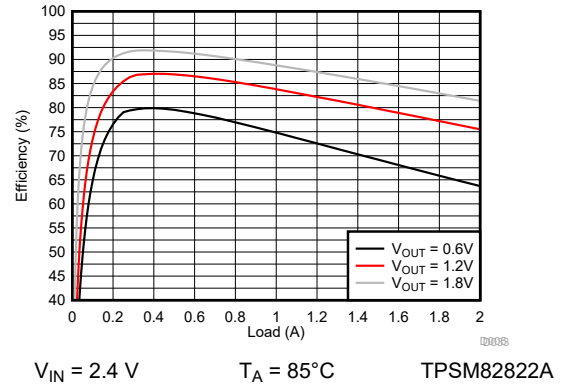

Figure 9-93. Efficiency

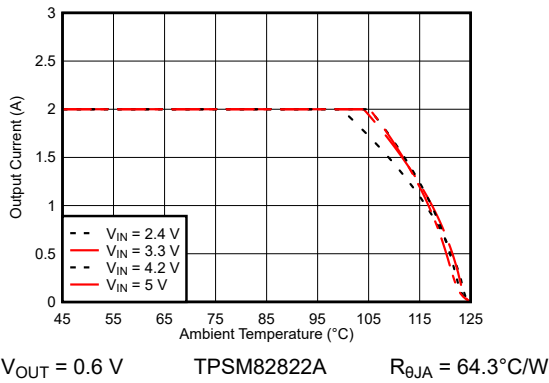

Figure 9-94. Safe Operating Area

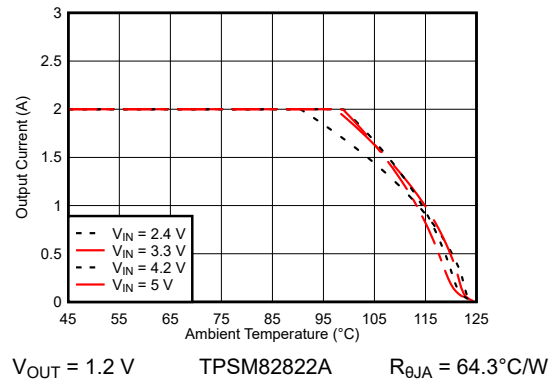

Figure 9-95. Safe Operating Area

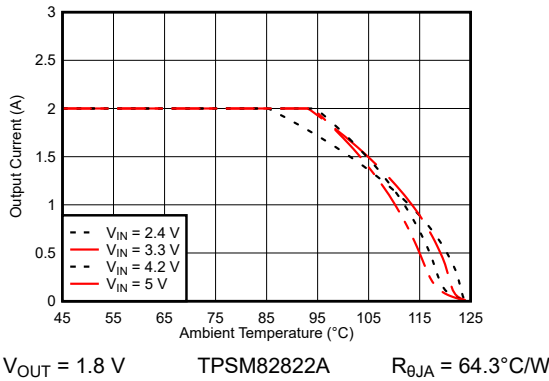

Figure 9-96. Safe Operating Area

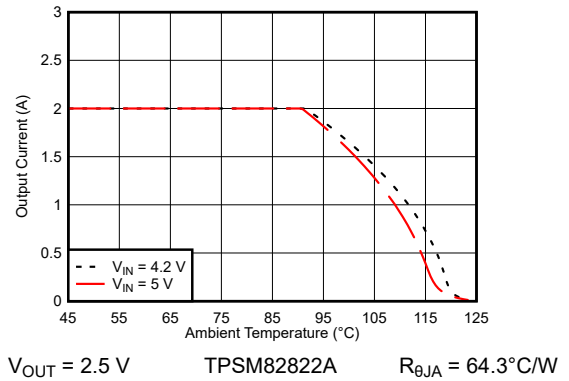
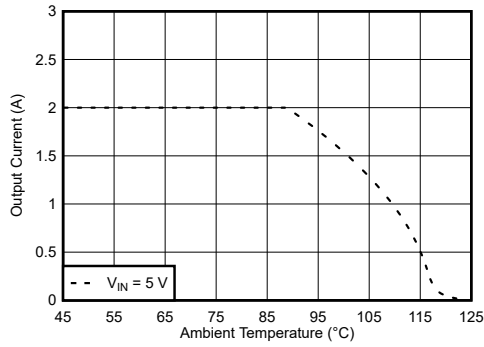
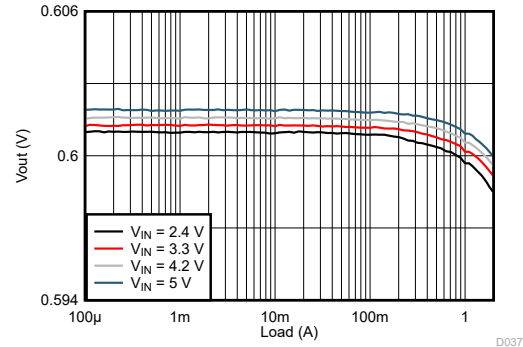

Figure 9-97. Safe Operating Area



$V_{OUT} = 3.3\text{ V}$ TPSM82822A $R_{\theta JA} = 64.3^{\circ}\text{C/W}$

Figure 9-98. Safe Operating Area



$V_{OUT} = 0.6\text{ V}$ TPSM82822A

Figure 9-99. Load Regulation

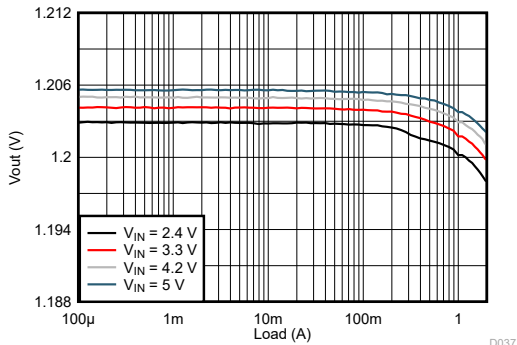

$V_{OUT} = 1.2\text{ V}$ TPSM82822A

Figure 9-100. Load Regulation

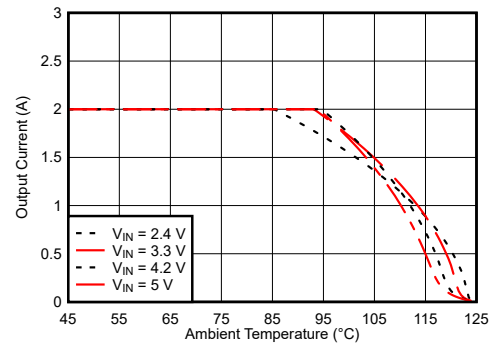

$V_{OUT} = 1.8\text{ V}$ TPSM82822A

Figure 9-101. Load Regulation

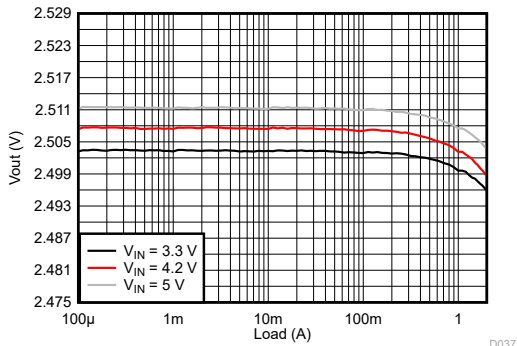

$V_{OUT} = 2.5\text{ V}$ TPSM82822A

Figure 9-102. Load Regulation

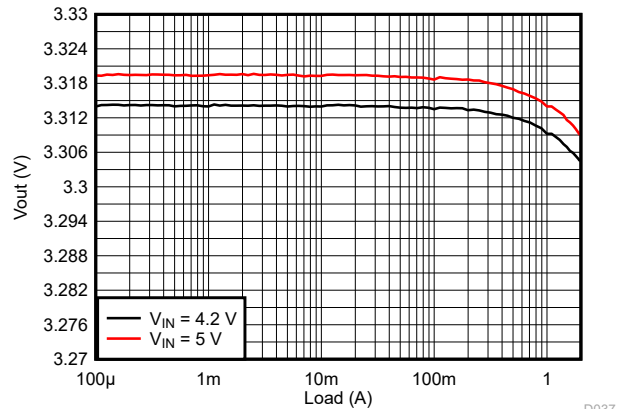

$V_{OUT} = 3.3\text{ V}$ TPSM82822A

Figure 9-103. Load Regulation

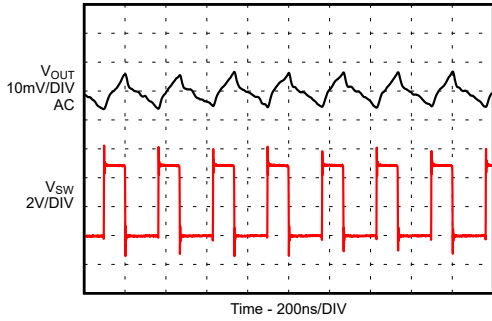

$I_{OUT} = 2\text{ A}$ TPSM82822A

Figure 9-104. Output Ripple in PWM Mode

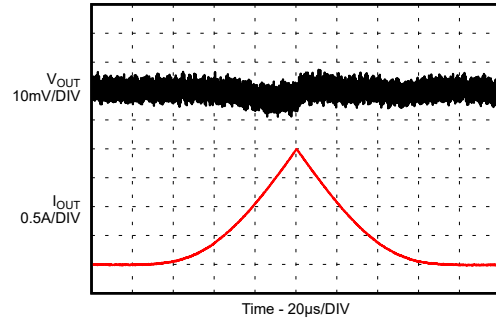

$I_{OUT} = 0\text{ mA to }2\text{ A}$ TPSM82822A

Figure 9-105. Load Sweep

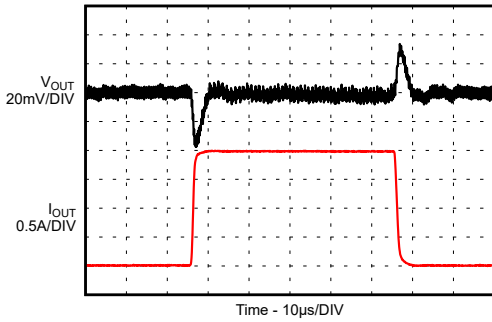

$I_{OUT} = 0\text{ A to }2\text{ A}$ Slew Rate = $2\text{ A}/\mu\text{s}$ TPSM82822A

Figure 9-106. Load Transient

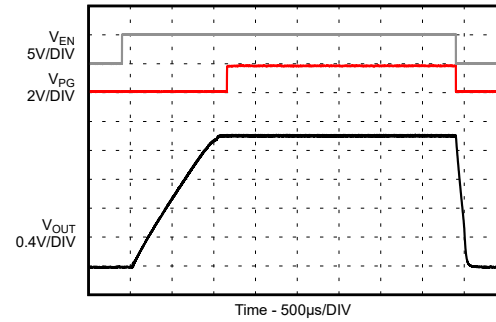

$I_{OUT} = \text{no load}$ TPSM82822A

Figure 9-107. Start-up / Shutdown without Load

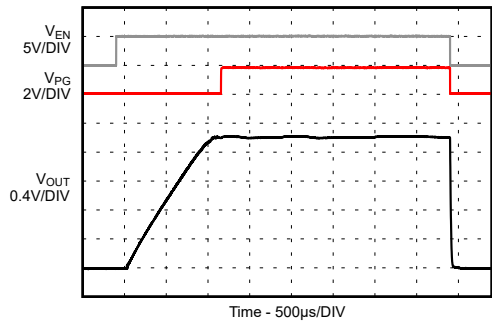

$I_{OUT} = 2\text{ A}$ TPSM82822A

Figure 9-108. Start-up / Shutdown with Resistive Load

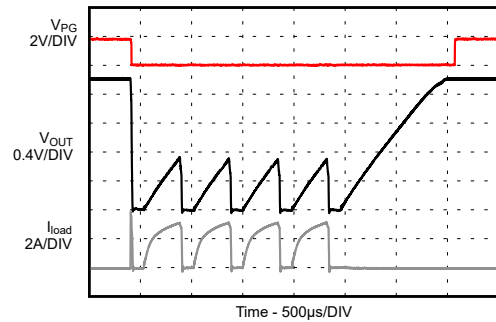

TPSM82822A

Figure 9-109. Short Circuit, HICCU Protection Entry / Exit

9.2.1.3.5 TPSM82823 Performance Curves

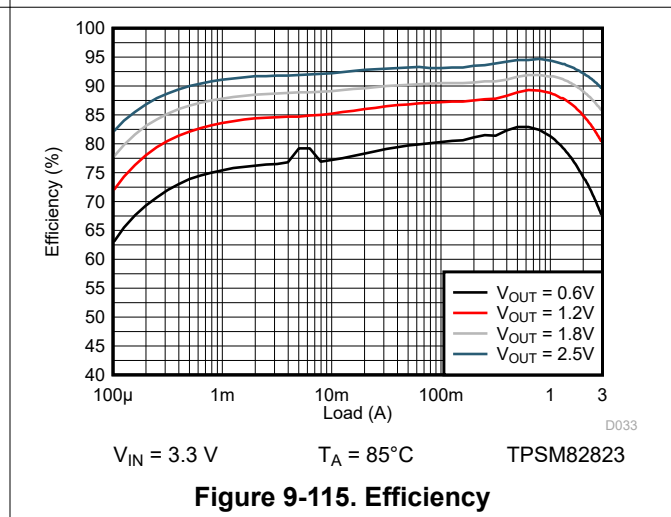
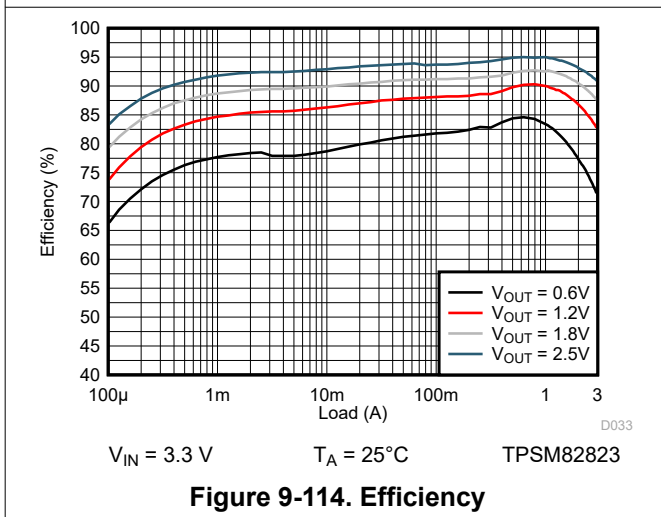
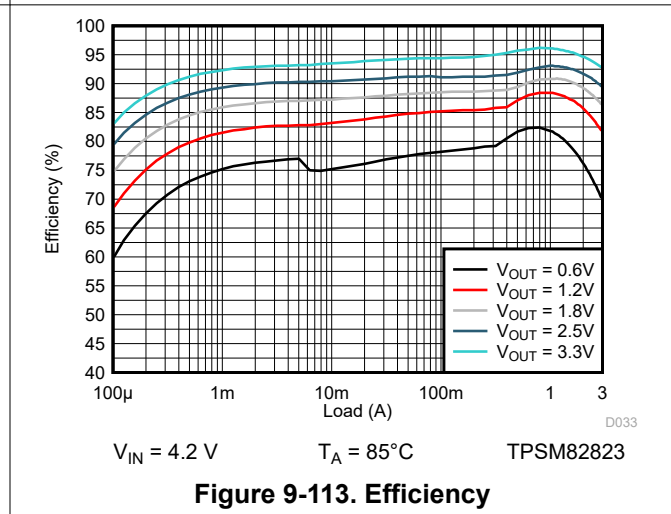
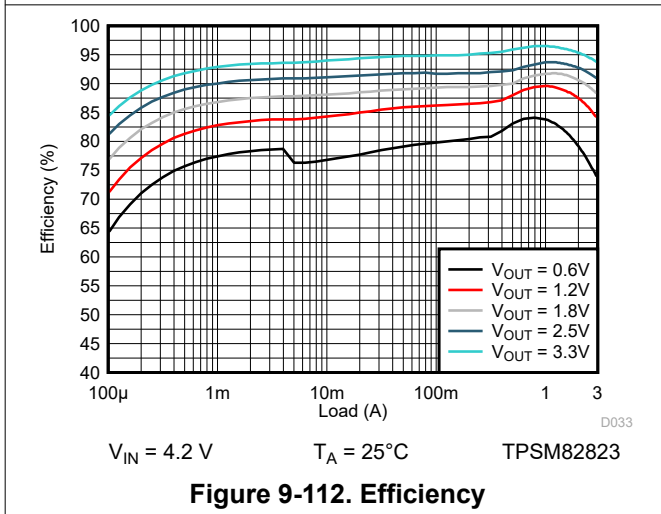
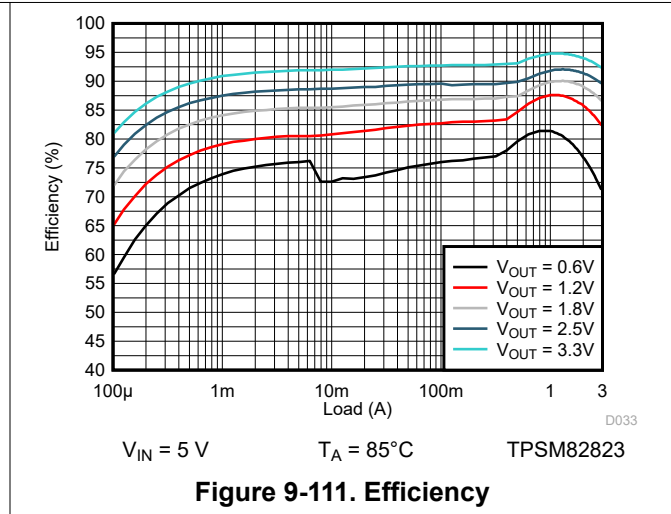
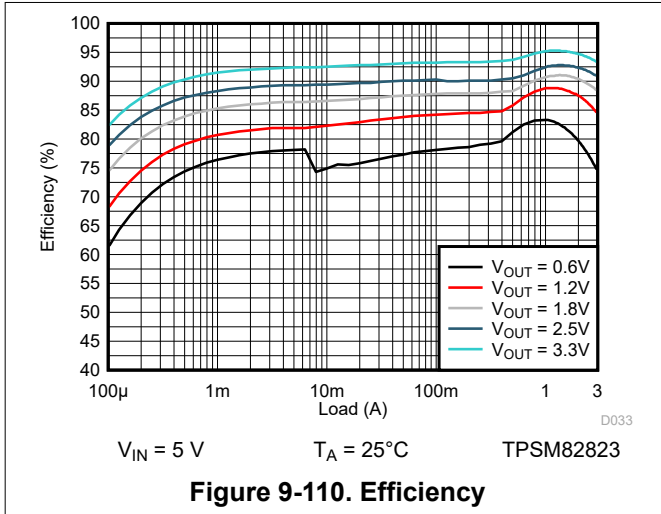

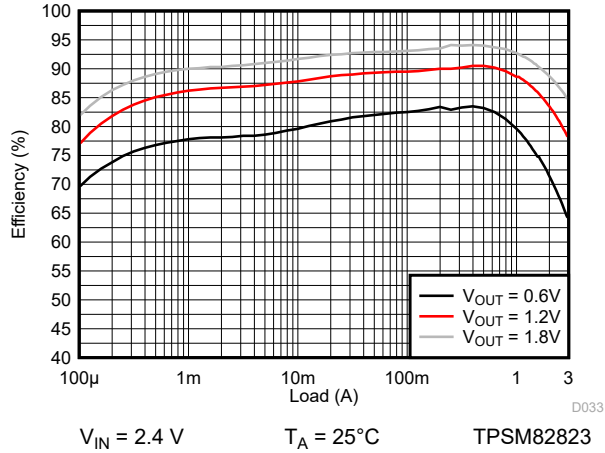

Figure 9-116. Efficiency

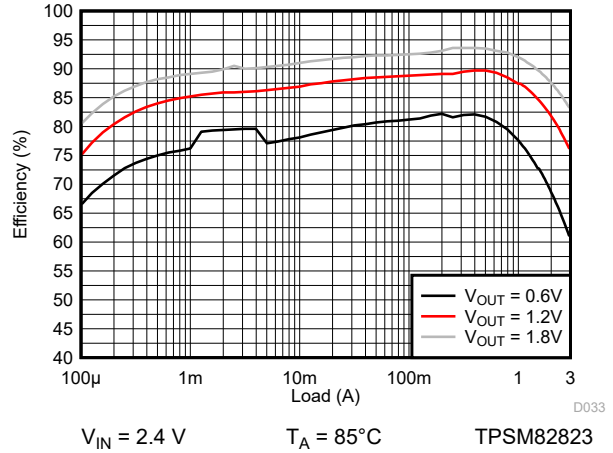

Figure 9-117. Efficiency

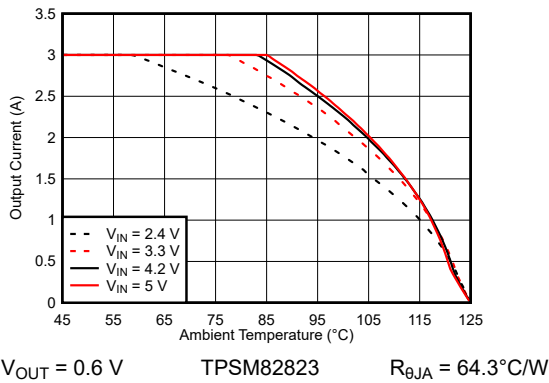

Figure 9-118. Safe Operating Area

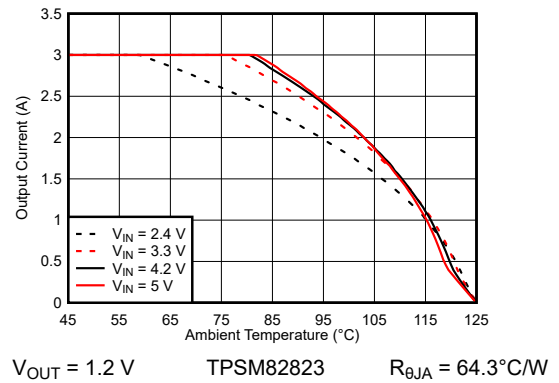

Figure 9-119. Safe Operating Area

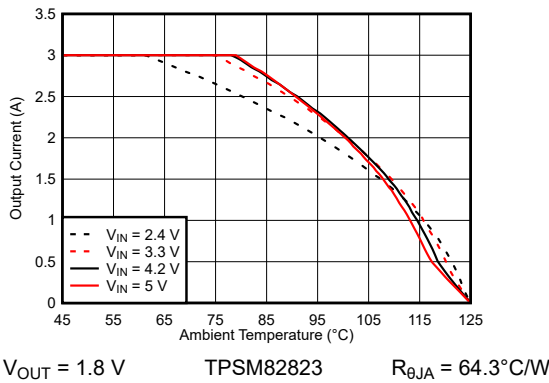

Figure 9-120. Safe Operating Area

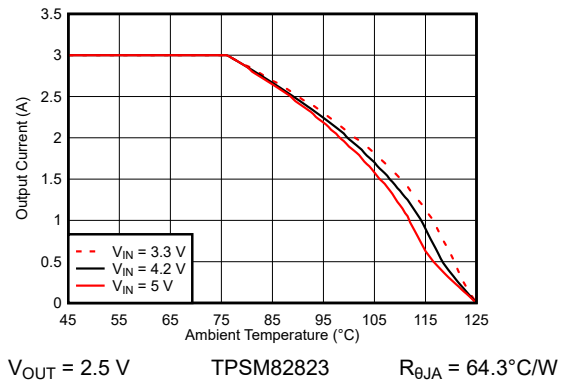

Figure 9-121. Safe Operating Area

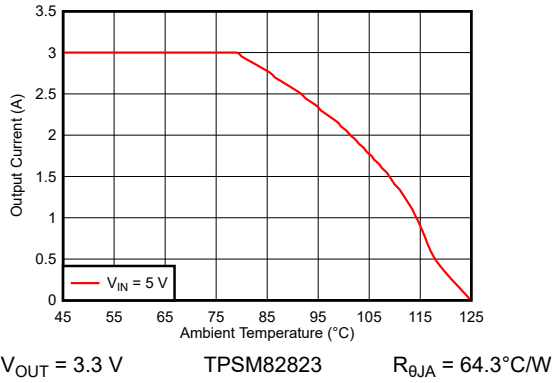

Figure 9-122. Safe Operating Area

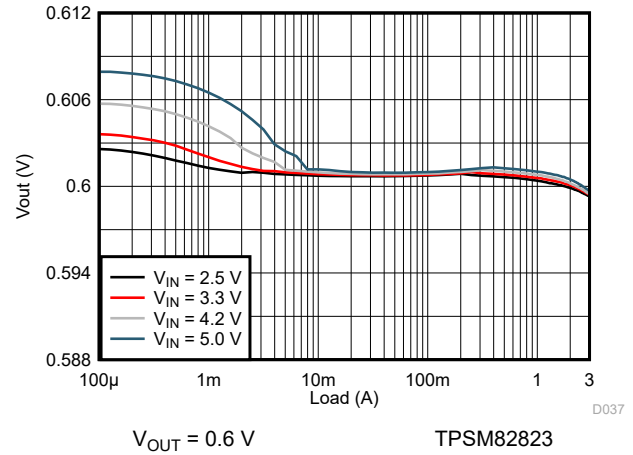

Figure 9-123. Load Regulation

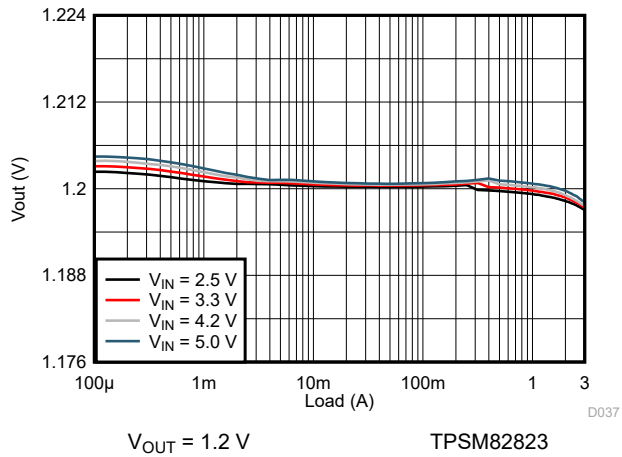

Figure 9-124. Load Regulation

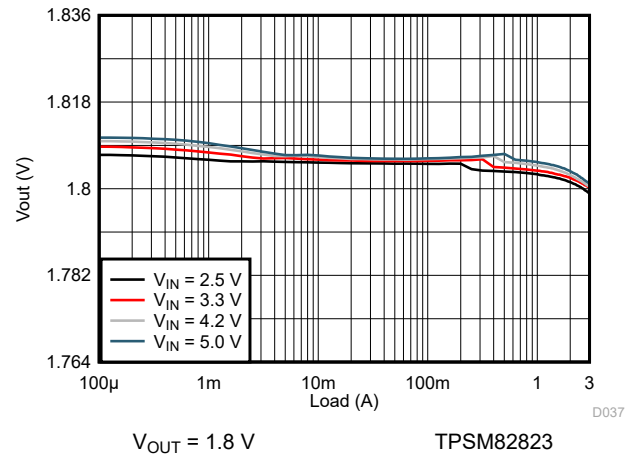

Figure 9-125. Load Regulation

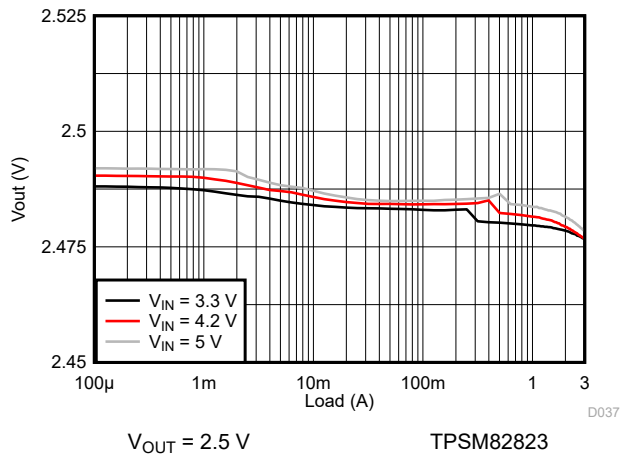

Figure 9-126. Load Regulation

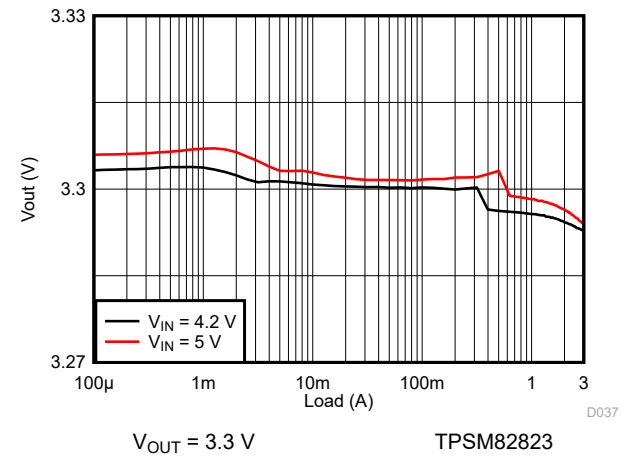
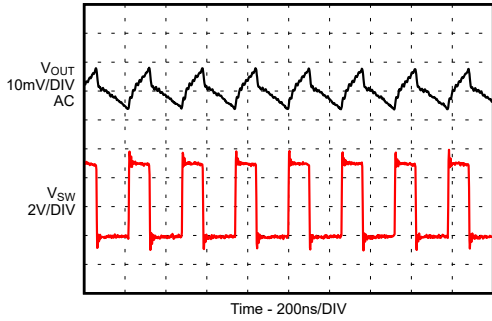
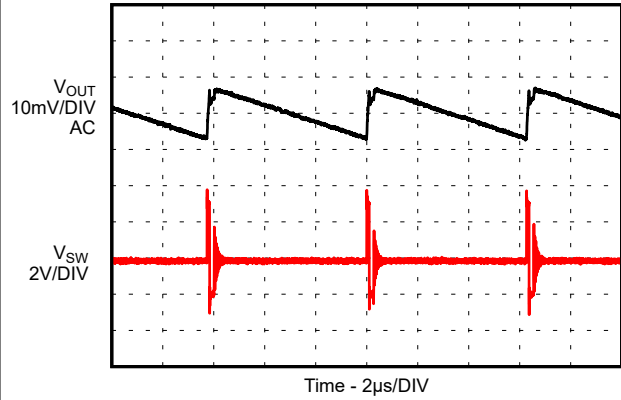

Figure 9-127. Load Regulation



$I_{OUT} = 3\text{ A}$ TPSM82823

Figure 9-128. Output Ripple in PWM Mode



$I_{OUT} = 25\text{ mA}$ TPSM82823

Figure 9-129. Output Ripple in PSM Mode

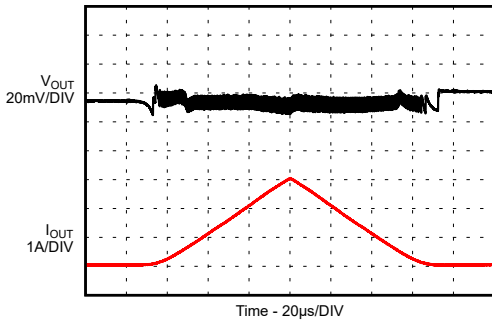

$I_{OUT} = 25\text{ mA to } 3\text{ A}$ TPSM82823

Figure 9-130. Load Sweep

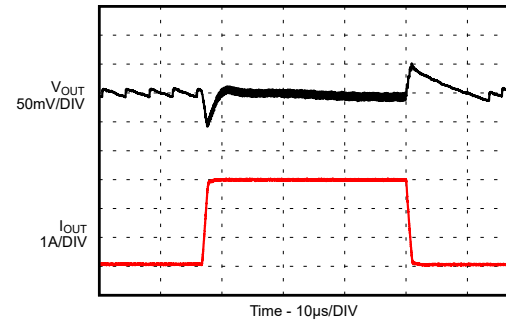

$I_{OUT} = 0\text{ A to } 3\text{ A}$ Slew Rate = $2\text{ A}/\mu\text{s}$ TPSM82823

Figure 9-131. Load Transient

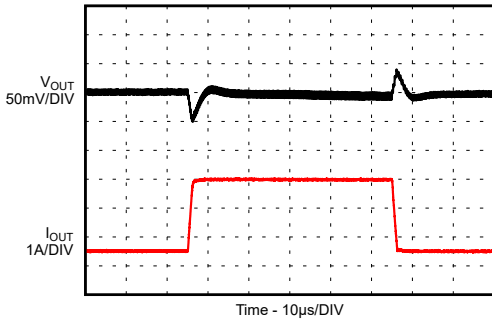

$I_{OUT} = 0.5\text{ A to } 3\text{ A}$ Slew Rate = $2\text{ A}/\mu\text{s}$ TPSM82823

Figure 9-132. Load Transient

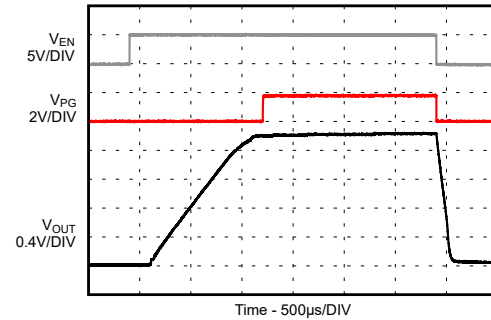

$I_{OUT} = \text{no load}$ TPSM82823

Figure 9-133. Start-up / Shutdown without Load

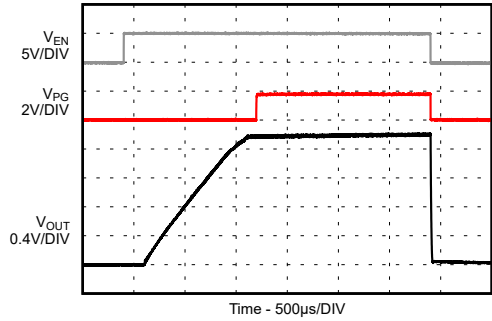

$I_{OUT} = 3\text{ A}$

TPSM82823

Figure 9-134. Start-up / Shutdown with Resistive Load

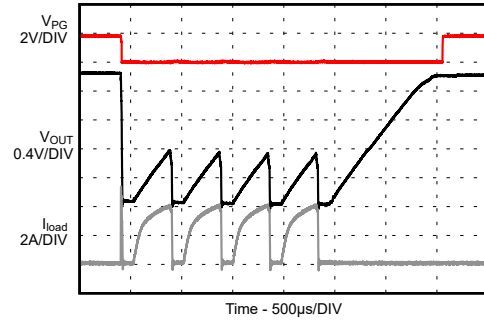

TPSM82823

Figure 9-135. Short Circuit, HICCUP Protection Entry / Exit

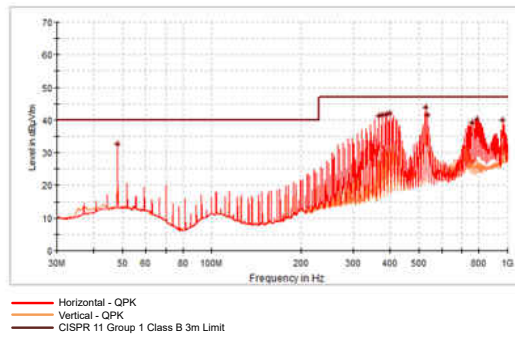

$R_{LOAD} = 0.68\ \Omega$, $V_{IN} = 5.5\text{ V}$ (battery supply), $V_{OUT} = 1.8\text{ V}$, tested on TPSM82823EVM-080

Figure 9-136. TPSM82823 Radiated Emissions

9.2.1.3.6 TPSM82823A Performance Curves

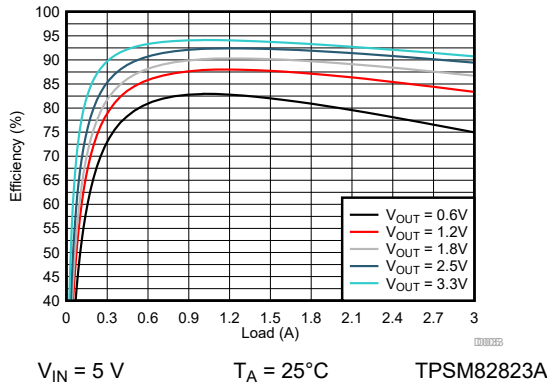

Figure 9-137. Efficiency

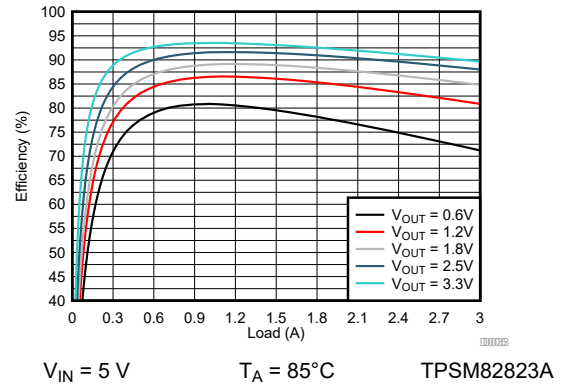

Figure 9-138. Efficiency

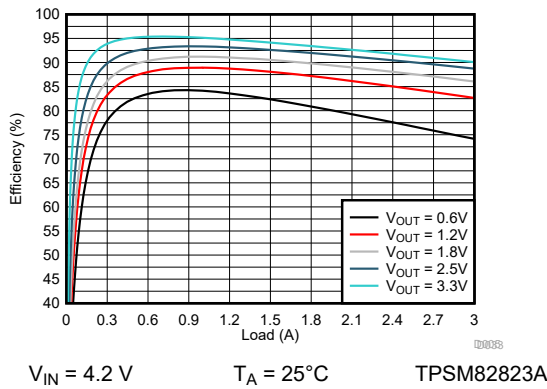

Figure 9-139. Efficiency

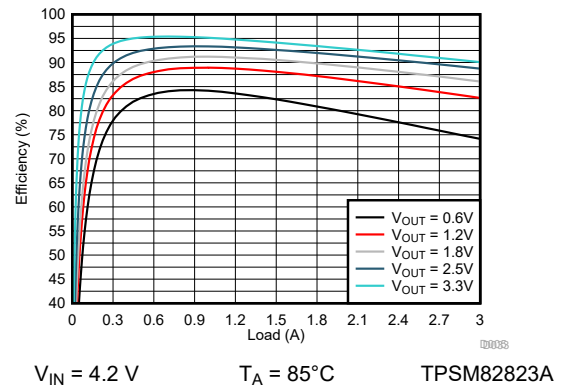

Figure 9-140. Efficiency

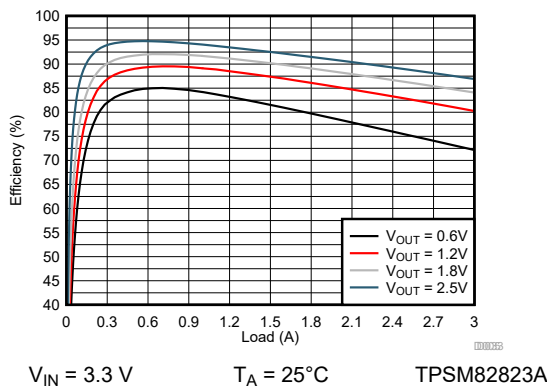

Figure 9-141. Efficiency

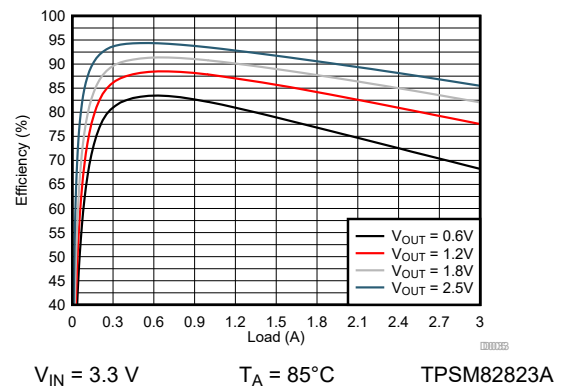
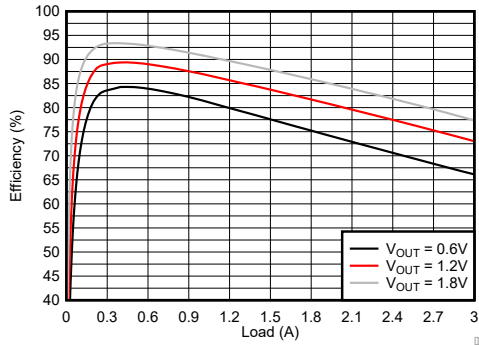
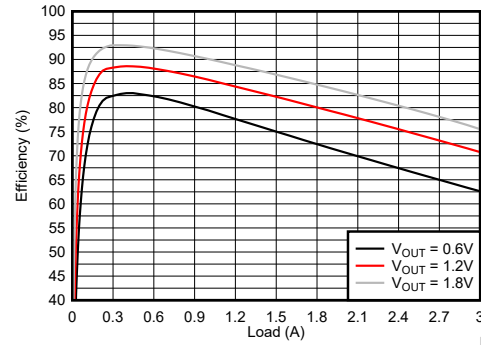

Figure 9-142. Efficiency



$V_{IN} = 2.4\text{ V}$ $T_A = 25^\circ\text{C}$ TPSM82823A

Figure 9-143. Efficiency



$V_{IN} = 2.4\text{ V}$ $T_A = 85^\circ\text{C}$ TPSM82823A

Figure 9-144. Efficiency

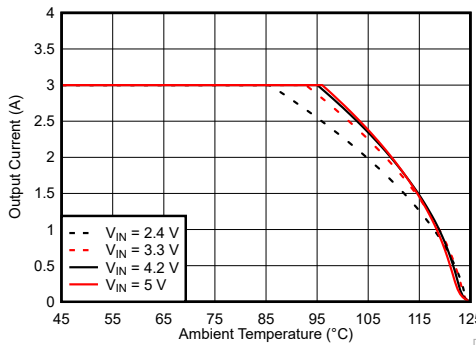

$V_{OUT} = 0.6\text{ V}$ TPSM82823A $R_{\theta JA} = 64.3\text{ }^\circ\text{C/W}$

Figure 9-145. Safe Operating Area

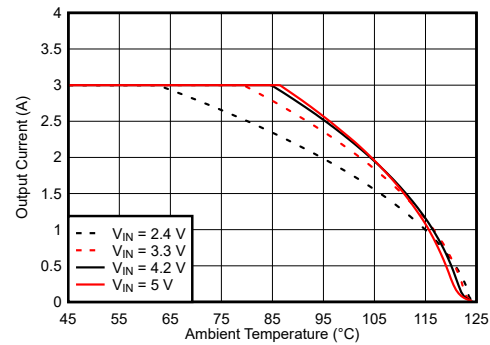

$V_{OUT} = 1.2\text{ V}$ TPSM82823A $R_{\theta JA} = 64.3\text{ }^\circ\text{C/W}$

Figure 9-146. Safe Operating Area

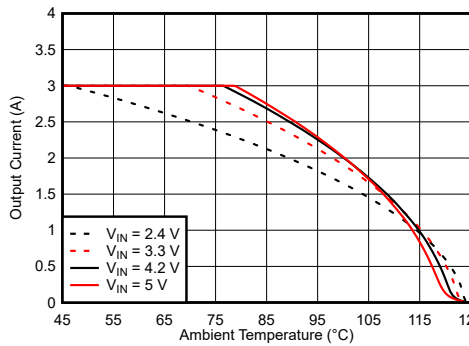

$V_{OUT} = 1.8\text{ V}$ TPSM82823A $R_{\theta JA} = 64.3\text{ }^\circ\text{C/W}$

Figure 9-147. Safe Operating Area

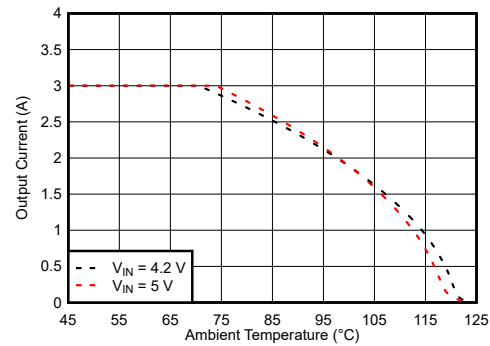

$V_{OUT} = 2.5\text{ V}$ TPSM82823A $R_{\theta JA} = 64.3\text{ }^\circ\text{C/W}$

Figure 9-148. Safe Operating Area

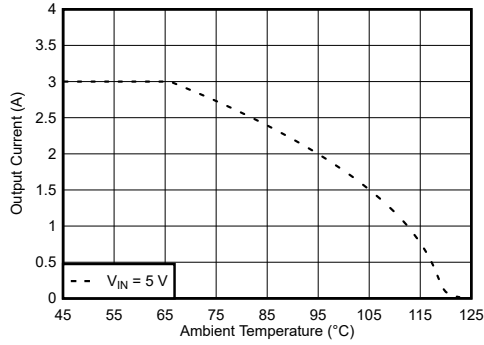

$V_{OUT} = 3.3\text{ V}$ **TPSM82823A** $R_{\theta JA} = 64.3\text{ }^{\circ}\text{C/W}$

Figure 9-149. Safe Operating Area

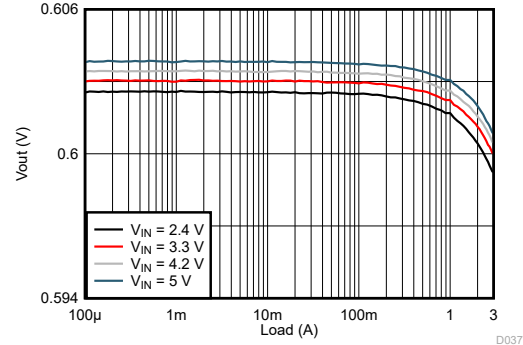

$V_{OUT} = 0.6\text{ V}$ **TPSM82823A**

Figure 9-150. Load Regulation

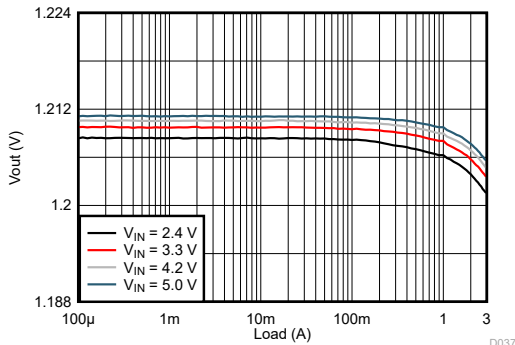

$V_{OUT} = 1.2\text{ V}$ **TPSM82823A**

Figure 9-151. Load Regulation

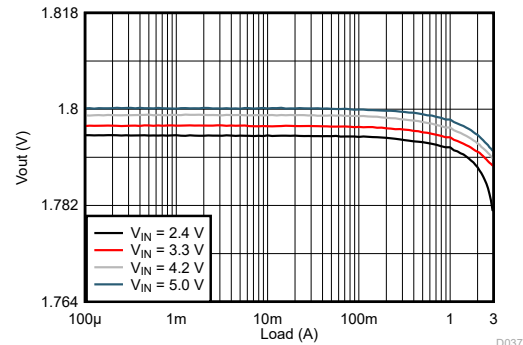

$V_{OUT} = 1.8\text{ V}$ **TPSM82823A**

Figure 9-152. Load Regulation

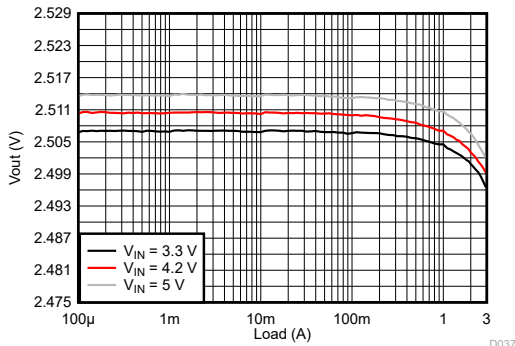

$V_{OUT} = 2.5\text{ V}$ **TPSM82823A**

Figure 9-153. Load Regulation

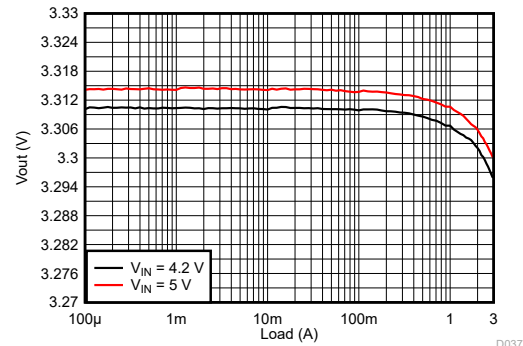

$V_{OUT} = 3.3\text{ V}$ **TPSM82823A**

Figure 9-154. Load Regulation

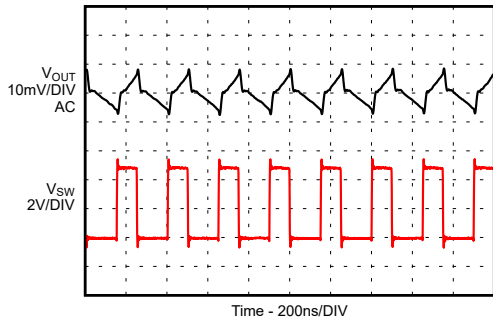

$I_{OUT} = 3\text{ A}$ TPSM82823A

Figure 9-155. Output Ripple in PWM Mode

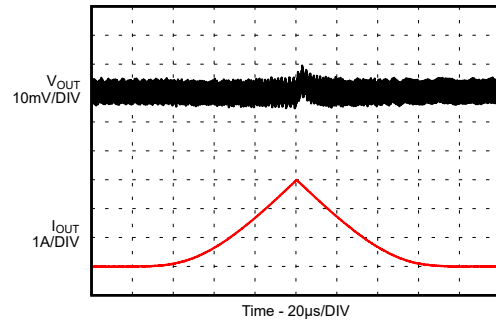

$I_{OUT} = 0\text{ mA to }3\text{ A}$ TPSM82823A

Figure 9-156. Load Sweep

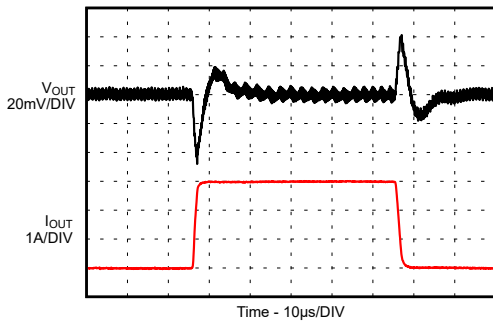

$I_{OUT} = 0\text{ A to }3\text{ A}$ Slew Rate = $2\text{ A}/\mu\text{s}$ TPSM82823A

Figure 9-157. Load Transient

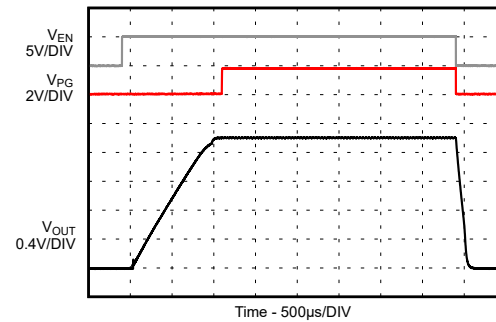

$I_{OUT} = \text{no load}$ TPSM82823A

Figure 9-158. Start-up / Shutdown without Load

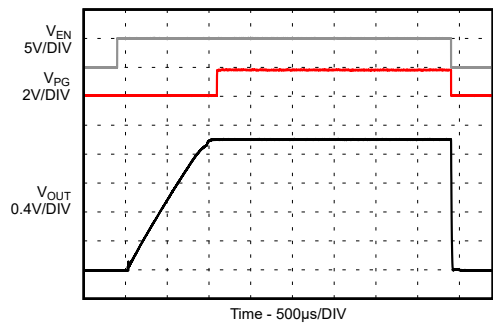

$I_{OUT} = 3\text{ A}$ TPSM82823A

Figure 9-159. Start-up / Shutdown with Resistive Load

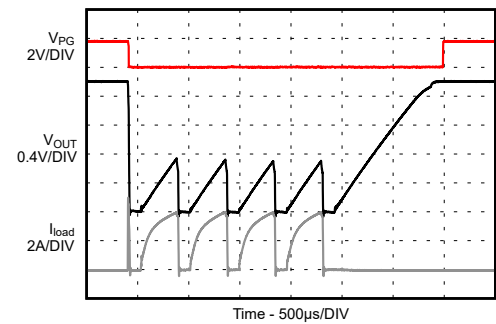

TPSM82823A

Figure 9-160. Short Circuit, HICCU Protection Entry / Exit

10 Power Supply Recommendations

The devices are designed to operate from an input supply voltage range between 2.4 V and 5.5 V. The average input current of the TPSM8282x/TPSM8282xA is calculated as:

$$I_{IN} = \frac{1}{\eta} \times \frac{V_{OUT} \times I_{OUT}}{V_{IN}} \quad (7)$$

Ensure that the power supply has a sufficient current rating for the application.

11 Layout

11.1 Layout Guidelines

A proper layout is critical for the operation of any switched mode power supply, especially at high switching frequencies. Therefore, the PCB layout of the TPSM8282x/TPSM8282xA demands careful attention to ensure best performance. A poor layout can lead to issues like bad line and load regulation, instability, increased EMI radiation, and noise sensitivity. Refer to the [Five Steps to a Great PCB Layout for a Step-Down Converter Technical Brief](#) for a detailed discussion of general best practices. Specific recommendations for the device are listed below.

- The input capacitor should be placed as close as possible to the VIN and GND pins of the device. This is the most critical component placement. Route the input capacitor directly to the VIN and GND pins avoiding vias.
- Place the output capacitor ground close to the VOUT and GND pins and route it directly avoiding vias.
- Place the FB resistors, R1 and R2, and the feedforward capacitor C_{FF} close to the FB pin to minimize noise pickup.
- The recommended layout is implemented on the EVM and shown in its [TPSM8282xEVM-080 Evaluation Module User's Guide](#)
- The recommended land pattern for the TPSM8282x/TPSM8282xA is shown at the end of this data sheet. For best manufacturing results, it is important to create the pads as solder mask defined (SMD), when some pins (such as VIN, VOUT, and GND) are connected to large copper planes. Using SMD pads keeps each pad the same size and avoids solder pulling the device during reflow.

11.2 Layout Example

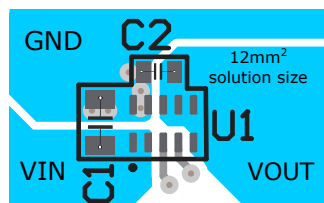

Figure 11-1. TPSM8282xx PCB Layout for the Fixed Output Voltage Devices (BOM from Table 9-2)

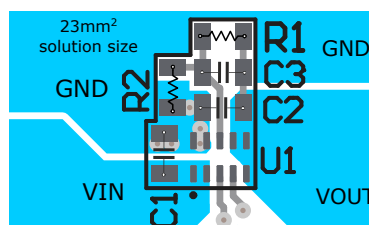

Figure 11-2. TPSM8282x/TPSM8282xA PCB Layout for the Adjustable Devices (BOM from Table 9-1 with 1 x 22-µF for C2)

11.2.1 Thermal Consideration

The TPSM8282x/TPSM8282xA module temperature must be kept less than the maximum rating of 125°C. The following are three basic approaches for enhancing thermal performance:

- Improve the power dissipation capability of the PCB design.
- Improve the thermal coupling of the component to the PCB.
- Introduce airflow into the system.

To estimate the approximate module temperature of the TPSM8282x/TPSM8282xA, apply the typical efficiency stated in this data sheet to the desired application condition to compute the power dissipation of the module. Then, calculate the module temperature rise by multiplying the power dissipation by its thermal resistance. Using this method to compute the maximum device temperature, the Safe Operating Area (SOA) graphs demonstrate the required derating in maximum output current at high ambient temperatures. For more details on how to use the thermal parameters in real applications, see the application notes: [Thermal Characteristics of Linear and Logic Packages Using JEDEC PCB Designs](#) and [Semiconductor and IC Package Thermal Metrics](#).

12 Device and Documentation Support

12.1 Device Support

12.1.1 Third-Party Products Disclaimer

TI'S PUBLICATION OF INFORMATION REGARDING THIRD-PARTY PRODUCTS OR SERVICES DOES NOT CONSTITUTE AN ENDORSEMENT REGARDING THE SUITABILITY OF SUCH PRODUCTS OR SERVICES OR A WARRANTY, REPRESENTATION OR ENDORSEMENT OF SUCH PRODUCTS OR SERVICES, EITHER ALONE OR IN COMBINATION WITH ANY TI PRODUCT OR SERVICE.

12.1.2 Development Support

12.1.2.1 Models and Simulators

PSpice® for TI is a design and simulation environment that helps evaluate performance of analog circuits. Create subsystem designs and prototype solutions before committing to layout and fabrication, reducing development cost and time to market.

12.2 Documentation Support

12.2.1 Related Documentation

For related documentation see the following:

Texas Instruments, [TPSM82822EVM-080 Evaluation Module, SLVUBR5](#)

12.3 Receiving Notification of Documentation Updates

To receive notification of documentation updates, navigate to the device product folder on [ti.com](#). Click on *Subscribe to updates* to register and receive a weekly digest of any product information that has changed. For change details, review the revision history included in any revised document.

12.4 Trademarks

MicroSiP™ are trademarks of TI.

All trademarks are the property of their respective owners.

12.5 Electrostatic Discharge Caution



This integrated circuit can be damaged by ESD. Texas Instruments recommends that all integrated circuits be handled with appropriate precautions. Failure to observe proper handling and installation procedures can cause damage.

ESD damage can range from subtle performance degradation to complete device failure. Precision integrated circuits may be more susceptible to damage because very small parametric changes could cause the device not to meet its published specifications.

12.6 Glossary

[TI Glossary](#) This glossary lists and explains terms, acronyms, and definitions.

Mechanical, Packaging, and Orderable Information

The following pages include mechanical, packaging, and orderable information. This information is the most current data available for the designated devices. This data is subject to change without notice and revision of this document. For browser-based versions of this data sheet, refer to the left-hand navigation.

13.1 Tape and Reel Information

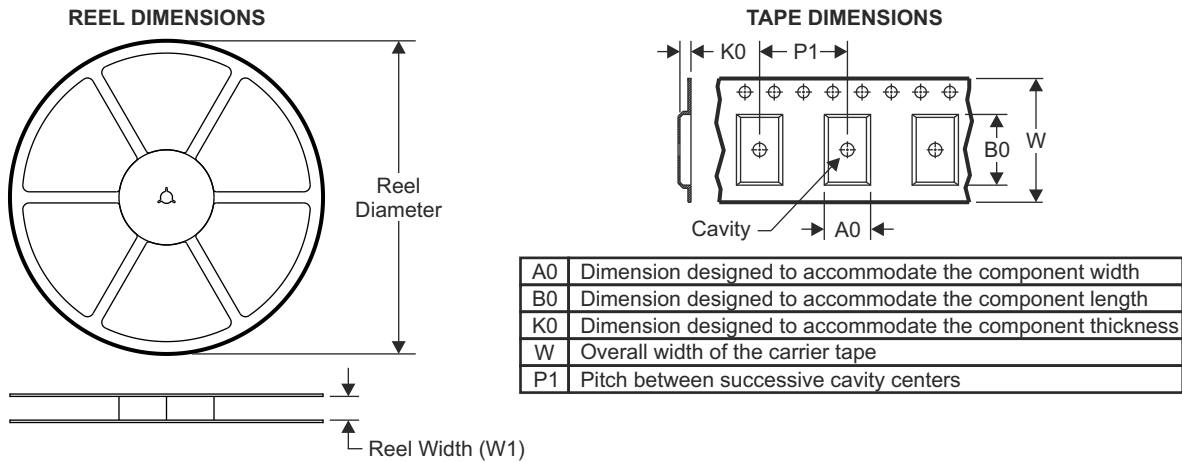

QUADRANT ASSIGNMENTS FOR PIN 1 ORIENTATION IN TAPE

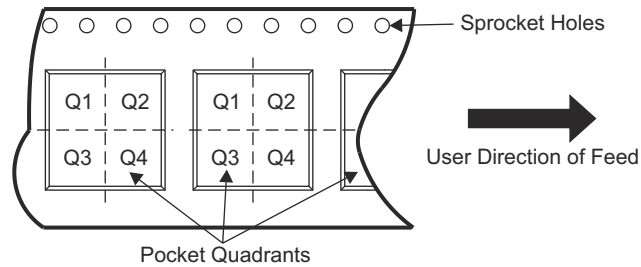

Device	Package Type	Package Drawing	Pins	SPQ	Reel Diameter (mm)	Reel Width W1 (mm)	A0 (mm)	B0 (mm)	K0 (mm)	P1 (mm)	W (mm)	Pin1 Quadrant
TPSM82821SILR	uSiP	SIL	10	3000	330.0	8.4	2.25	2.75	1.25	4.0	8.0	Q1
TPSM82821ASILR	uSiP	SIL	10	3000	330.0	8.4	2.25	2.75	1.25	4.0	8.0	Q1
TPSM828211SILR	uSiP	SIL	10	3000	330.0	8.4	2.25	2.75	1.25	4.0	8.0	Q1
TPSM828212SILR	uSiP	SIL	10	3000	330.0	8.4	2.25	2.75	1.25	4.0	8.0	Q1
TPSM828213SILR	uSiP	SIL	10	3000	330.0	8.4	2.25	2.75	1.25	4.0	8.0	Q1
TPSM828214SILR	uSiP	SIL	10	3000	330.0	8.4	2.25	2.75	1.25	4.0	8.0	Q1
TPSM82822SILR	uSiP	SIL	10	3000	330.0	8.4	2.25	2.75	1.25	4.0	8.0	Q1
TPSM82822ASILR	uSiP	SIL	10	3000	330.0	8.4	2.25	2.75	1.25	4.0	8.0	Q1
TPSM828221SILR	uSiP	SIL	10	3000	330.0	8.4	2.25	2.75	1.25	4.0	8.0	Q1
TPSM828222SILR	uSiP	SIL	10	3000	330.0	8.4	2.25	2.75	1.25	4.0	8.0	Q1
TPSM828223SILR	uSiP	SIL	10	3000	330.0	8.4	2.25	2.75	1.25	4.0	8.0	Q1
TPSM828224SILR	uSiP	SIL	10	3000	330.0	8.4	2.25	2.75	1.25	4.0	8.0	Q1
TPSM82823SILR	uSiP	SIL	10	3000	330.0	8.4	2.25	2.75	1.25	4.0	8.0	Q1
TPSM82823ASILR	uSiP	SIL	10	3000	330.0	8.4	2.25	2.75	1.25	4.0	8.0	Q1

TAPE AND REEL BOX DIMENSIONS

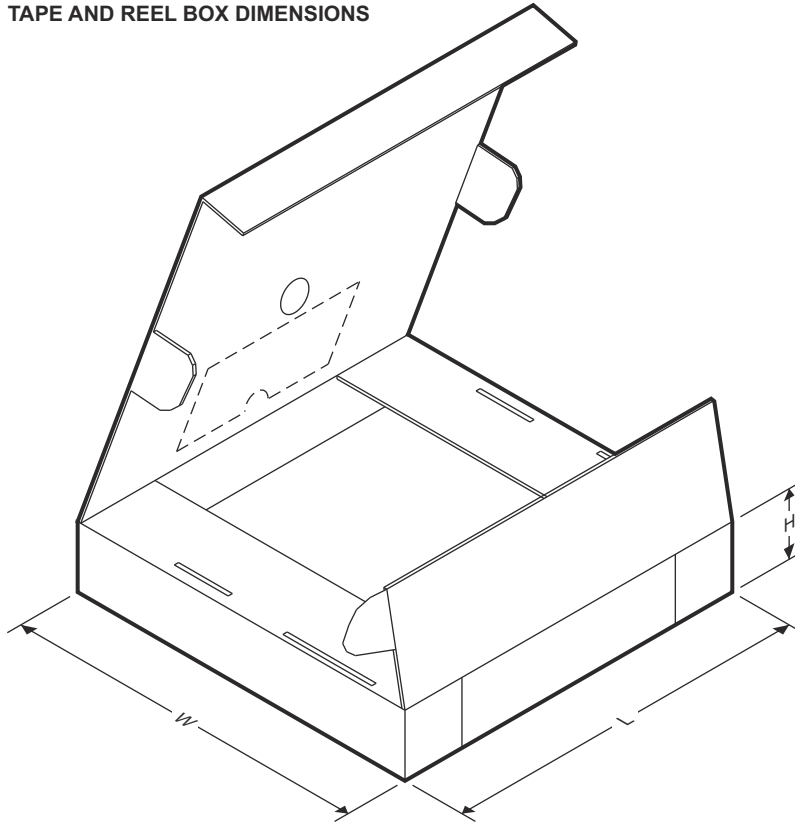

Device	Package Type	Package Drawing	Pins	SPQ	Length (mm)	Width (mm)	Height (mm)
TPSM82821SILR	uSiP	SIL	10	3000	383.0	353.0	58.0
TPSM82821ASILR	uSiP	SIL	10	3000	383.0	353.0	58.0
TPSM828211SILR	uSiP	SIL	10	3000	383.0	353.0	58.0
TPSM828212SILR	uSiP	SIL	10	3000	383.0	353.0	58.0
TPSM828213SILR	uSiP	SIL	10	3000	383.0	353.0	58.0
TPSM828214SILR	uSiP	SIL	10	3000	383.0	353.0	58.0
TPSM82822SILR	uSiP	SIL	10	3000	383.0	353.0	58.0
TPSM82822ASILR	uSiP	SIL	10	3000	383.0	353.0	58.0
TPSM828221SILR	uSiP	SIL	10	3000	383.0	353.0	58.0
TPSM828222SILR	uSiP	SIL	10	3000	383.0	353.0	58.0
TPSM828223SILR	uSiP	SIL	10	3000	383.0	353.0	58.0
TPSM828224SILR	uSiP	SIL	10	3000	383.0	353.0	58.0
TPSM82823SILR	uSiP	SIL	10	3000	383.0	353.0	58.0
TPSM82823ASILR	uSiP	SIL	10	3000	383.0	353.0	58.0

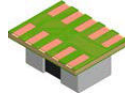

PACKAGE OUTLINE

SIL0010D

uSIP™ - 1.1 mm max height

MICRO SYSTEM IN PACKAGE

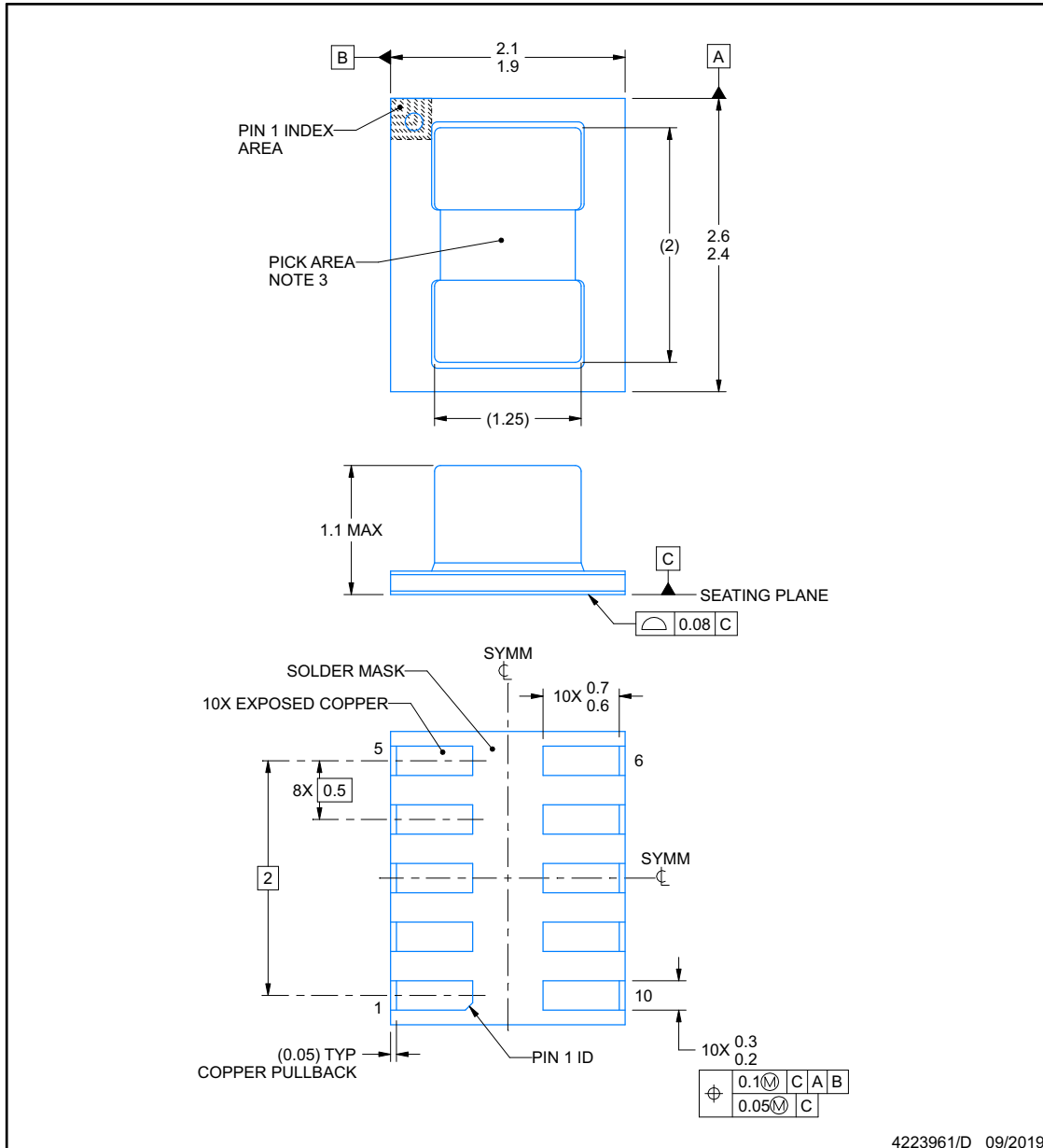

4223961/D 09/2019

MicroSiP is a trademark of Texas Instruments

NOTES:

1. All linear dimensions are in millimeters. Any dimensions in parenthesis are for reference only. Dimensioning and tolerancing per ASME Y14.5M.
2. This drawing is subject to change without notice.
3. Pick and place nozzle \varnothing 0.33 mm or smaller recommended.

EXAMPLE BOARD LAYOUT

SIL0010D

uSIP™ - 1.1 mm max height

MICRO SYSTEM IN PACKAGE

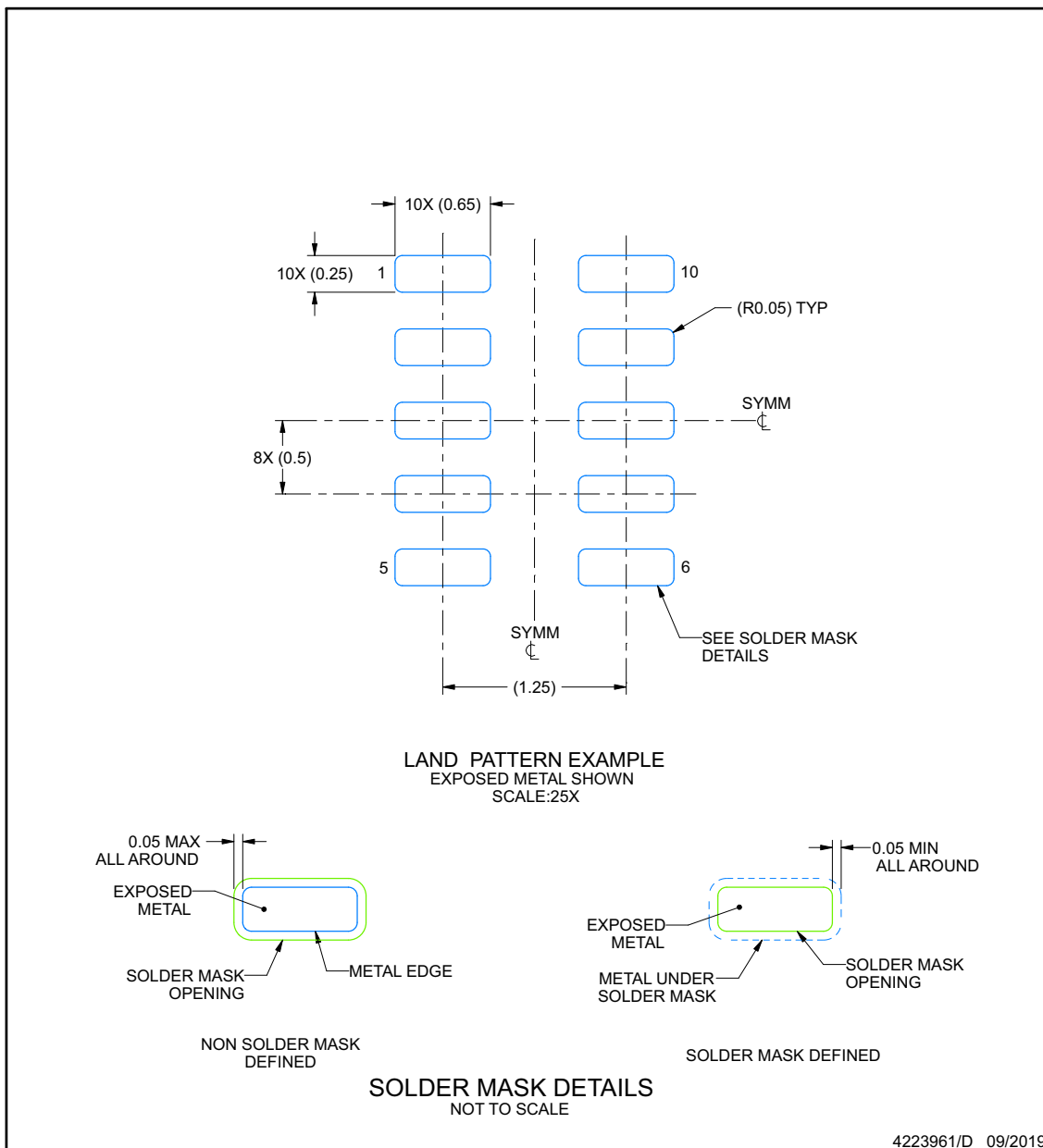

NOTES: (continued)

4. For more information, see Texas Instruments literature number SLUA271 (www.ti.com/lit/slua271).

EXAMPLE STENCIL DESIGN

SIL0010D

uSIP™ - 1.1 mm max height

MICRO SYSTEM IN PACKAGE

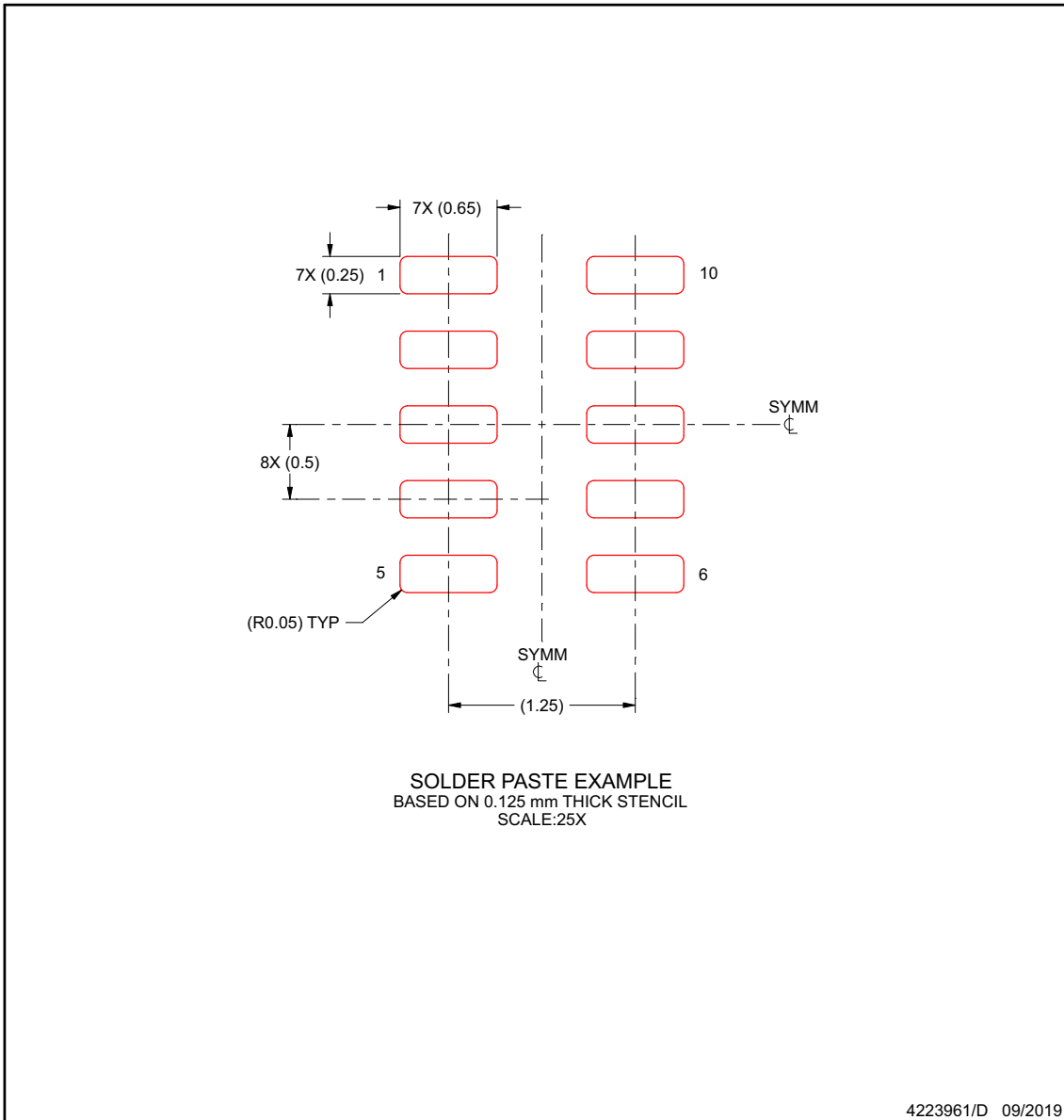

NOTES: (continued)

5. Laser cutting apertures with trapezoidal walls and rounded corners may offer better paste release. IPC-7525 may have alternate design recommendations.

PACKAGING INFORMATION

Orderable part number	Status (1)	Material type (2)	Package Pins	Package qty Carrier	RoHS (3)	Lead finish/ Ball material (4)	MSL rating/ Peak reflow (5)	Op temp (°C)	Part marking (6)
TPSM828211SILR	Active	Production	uSiP (SIL) 10	3000 LARGE T&R	Yes	ENEPIG	Level-2-260C-1 YEAR	-40 to 125	GA1
TPSM828211SILR.A	Active	Production	uSiP (SIL) 10	3000 LARGE T&R	Yes	ENEPIG	Level-2-260C-1 YEAR	-40 to 125	GA1
TPSM828211SILR.B	Active	Production	uSiP (SIL) 10	3000 LARGE T&R	-	Call TI	Call TI	-40 to 125	
TPSM828212SILR	Active	Production	uSiP (SIL) 10	3000 LARGE T&R	Yes	ENEPIG	Level-2-260C-1 YEAR	-40 to 125	GA2
TPSM828212SILR.A	Active	Production	uSiP (SIL) 10	3000 LARGE T&R	Yes	ENEPIG	Level-2-260C-1 YEAR	-40 to 125	GA2
TPSM828212SILR.B	Active	Production	uSiP (SIL) 10	3000 LARGE T&R	-	Call TI	Call TI	-40 to 125	
TPSM828213SILR	Active	Production	uSiP (SIL) 10	3000 LARGE T&R	Yes	ENEPIG	Level-2-260C-1 YEAR	-40 to 125	GA3
TPSM828213SILR.A	Active	Production	uSiP (SIL) 10	3000 LARGE T&R	Yes	ENEPIG	Level-2-260C-1 YEAR	-40 to 125	GA3
TPSM828213SILR.B	Active	Production	uSiP (SIL) 10	3000 LARGE T&R	-	Call TI	Call TI	-40 to 125	
TPSM828214SILR	Active	Production	uSiP (SIL) 10	3000 LARGE T&R	Yes	ENEPIG	Level-2-260C-1 YEAR	-40 to 125	GA4
TPSM828214SILR.A	Active	Production	uSiP (SIL) 10	3000 LARGE T&R	Yes	ENEPIG	Level-2-260C-1 YEAR	-40 to 125	GA4
TPSM828214SILR.B	Active	Production	uSiP (SIL) 10	3000 LARGE T&R	-	Call TI	Call TI	-40 to 125	
TPSM82821ASILR	Active	Production	uSiP (SIL) 10	3000 LARGE T&R	Yes	NIPDAU	Level-2-260C-1 YEAR	-40 to 125	L5
TPSM82821ASILR.A	Active	Production	uSiP (SIL) 10	3000 LARGE T&R	Yes	NIPDAU	Level-2-260C-1 YEAR	-40 to 125	L5
TPSM82821ASILR.B	Active	Production	uSiP (SIL) 10	3000 LARGE T&R	-	Call TI	Call TI	-40 to 125	
TPSM82821SILR	Active	Production	uSiP (SIL) 10	3000 LARGE T&R	Yes	ENEPIG	Level-2-260C-1 YEAR	-40 to 125	GA
TPSM82821SILR.A	Active	Production	uSiP (SIL) 10	3000 LARGE T&R	Yes	ENEPIG	Level-2-260C-1 YEAR	-40 to 125	GA
TPSM82821SILR.B	Active	Production	uSiP (SIL) 10	3000 LARGE T&R	-	Call TI	Call TI	-40 to 125	
TPSM828221SILR	Active	Production	uSiP (SIL) 10	3000 LARGE T&R	Yes	ENEPIG	Level-2-260C-1 YEAR	-40 to 125	G91
TPSM828221SILR.A	Active	Production	uSiP (SIL) 10	3000 LARGE T&R	Yes	ENEPIG	Level-2-260C-1 YEAR	-40 to 125	G91
TPSM828221SILR.B	Active	Production	uSiP (SIL) 10	3000 LARGE T&R	-	Call TI	Call TI	-40 to 125	
TPSM828222SILR	Active	Production	uSiP (SIL) 10	3000 LARGE T&R	Yes	ENEPIG	Level-2-260C-1 YEAR	-40 to 125	G92
TPSM828222SILR.A	Active	Production	uSiP (SIL) 10	3000 LARGE T&R	Yes	ENEPIG	Level-2-260C-1 YEAR	-40 to 125	G92
TPSM828222SILR.B	Active	Production	uSiP (SIL) 10	3000 LARGE T&R	-	Call TI	Call TI	-40 to 125	
TPSM828223SILR	Active	Production	uSiP (SIL) 10	3000 LARGE T&R	Yes	ENEPIG	Level-2-260C-1 YEAR	-40 to 125	G93
TPSM828223SILR.A	Active	Production	uSiP (SIL) 10	3000 LARGE T&R	Yes	ENEPIG	Level-2-260C-1 YEAR	-40 to 125	G93
TPSM828223SILR.B	Active	Production	uSiP (SIL) 10	3000 LARGE T&R	-	Call TI	Call TI	-40 to 125	
TPSM828224SILR	Active	Production	uSiP (SIL) 10	3000 LARGE T&R	Yes	ENEPIG	Level-2-260C-1 YEAR	-40 to 125	G94
TPSM828224SILR.A	Active	Production	uSiP (SIL) 10	3000 LARGE T&R	Yes	ENEPIG	Level-2-260C-1 YEAR	-40 to 125	G94

Orderable part number	Status (1)	Material type (2)	Package Pins	Package qty Carrier	RoHS (3)	Lead finish/ Ball material (4)	MSL rating/ Peak reflow (5)	Op temp (°C)	Part marking (6)
TPSM828224SILR.B	Active	Production	uSiP (SIL) 10	3000 LARGE T&R	-	Call TI	Call TI	-40 to 125	
TPSM82822ASILR	Active	Production	uSiP (SIL) 10	3000 LARGE T&R	Yes	NIPDAU	Level-2-260C-1 YEAR	-40 to 125	L6
TPSM82822ASILR.A	Active	Production	uSiP (SIL) 10	3000 LARGE T&R	Yes	NIPDAU	Level-2-260C-1 YEAR	-40 to 125	L6
TPSM82822ASILR.B	Active	Production	uSiP (SIL) 10	3000 LARGE T&R	-	Call TI	Call TI	-40 to 125	
TPSM82822SILR	Active	Production	uSiP (SIL) 10	3000 LARGE T&R	Yes	ENEPIG	Level-2-260C-1 YEAR	-40 to 125	G9
TPSM82822SILR.A	Active	Production	uSiP (SIL) 10	3000 LARGE T&R	Yes	ENEPIG	Level-2-260C-1 YEAR	-40 to 125	G9
TPSM82822SILR.B	Active	Production	uSiP (SIL) 10	3000 LARGE T&R	-	Call TI	Call TI	-40 to 125	
TPSM82823ASILR	Active	Production	uSiP (SIL) 10	3000 LARGE T&R	Yes	NIPDAU	Level-2-260C-1 YEAR	-40 to 125	L7
TPSM82823ASILR.A	Active	Production	uSiP (SIL) 10	3000 LARGE T&R	Yes	NIPDAU	Level-2-260C-1 YEAR	-40 to 125	L7
TPSM82823ASILR.B	Active	Production	uSiP (SIL) 10	3000 LARGE T&R	-	Call TI	Call TI	-40 to 125	
TPSM82823SILR	Active	Production	uSiP (SIL) 10	3000 LARGE T&R	Yes	ENEPIG	Level-2-260C-1 YEAR	-40 to 125	KM
TPSM82823SILR.A	Active	Production	uSiP (SIL) 10	3000 LARGE T&R	Yes	ENEPIG	Level-2-260C-1 YEAR	-40 to 125	KM
TPSM82823SILR.B	Active	Production	uSiP (SIL) 10	3000 LARGE T&R	-	Call TI	Call TI	-40 to 125	

(1) **Status:** For more details on status, see our [product life cycle](#).

(2) **Material type:** When designated, preproduction parts are prototypes/experimental devices, and are not yet approved or released for full production. Testing and final process, including without limitation quality assurance, reliability performance testing, and/or process qualification, may not yet be complete, and this item is subject to further changes or possible discontinuation. If available for ordering, purchases will be subject to an additional waiver at checkout, and are intended for early internal evaluation purposes only. These items are sold without warranties of any kind.

(3) **RoHS values:** Yes, No, RoHS Exempt. See the [TI RoHS Statement](#) for additional information and value definition.

(4) **Lead finish/Ball material:** Parts may have multiple material finish options. Finish options are separated by a vertical ruled line. Lead finish/Ball material values may wrap to two lines if the finish value exceeds the maximum column width.

(5) **MSL rating/Peak reflow:** The moisture sensitivity level ratings and peak solder (reflow) temperatures. In the event that a part has multiple moisture sensitivity ratings, only the lowest level per JEDEC standards is shown. Refer to the shipping label for the actual reflow temperature that will be used to mount the part to the printed circuit board.

(6) **Part marking:** There may be an additional marking, which relates to the logo, the lot trace code information, or the environmental category of the part.

Multiple part markings will be inside parentheses. Only one part marking contained in parentheses and separated by a "-" will appear on a part. If a line is indented then it is a continuation of the previous line and the two combined represent the entire part marking for that device.

Important Information and Disclaimer: The information provided on this page represents TI's knowledge and belief as of the date that it is provided. TI bases its knowledge and belief on information provided by third parties, and makes no representation or warranty as to the accuracy of such information. Efforts are underway to better integrate information from third parties. TI has taken and continues to take reasonable steps to provide representative and accurate information but may not have conducted destructive testing or chemical analysis on incoming materials and chemicals. TI and TI suppliers consider certain information to be proprietary, and thus CAS numbers and other limited information may not be available for release.

In no event shall TI's liability arising out of such information exceed the total purchase price of the TI part(s) at issue in this document sold by TI to Customer on an annual basis.

TAPE AND REEL INFORMATION

QUADRANT ASSIGNMENTS FOR PIN 1 ORIENTATION IN TAPE

*All dimensions are nominal

Device	Package Type	Package Drawing	Pins	SPQ	Reel Diameter (mm)	Reel Width W1 (mm)	A0 (mm)	B0 (mm)	K0 (mm)	P1 (mm)	W (mm)	Pin1 Quadrant
TPSM828211SILR	uSiP	SIL	10	3000	330.0	8.4	2.25	2.75	1.25	4.0	8.0	Q1
TPSM828212SILR	uSiP	SIL	10	3000	330.0	8.4	2.25	2.75	1.25	4.0	8.0	Q1
TPSM828213SILR	uSiP	SIL	10	3000	330.0	8.4	2.25	2.75	1.25	4.0	8.0	Q1
TPSM828214SILR	uSiP	SIL	10	3000	330.0	8.4	2.25	2.75	1.25	4.0	8.0	Q1
TPSM82821ASILR	uSiP	SIL	10	3000	330.0	8.4	2.25	2.75	1.25	4.0	8.0	Q1
TPSM82821SILR	uSiP	SIL	10	3000	330.0	8.4	2.25	2.75	1.25	4.0	8.0	Q1
TPSM828221SILR	uSiP	SIL	10	3000	330.0	8.4	2.25	2.75	1.25	4.0	8.0	Q1
TPSM828222SILR	uSiP	SIL	10	3000	330.0	8.4	2.25	2.75	1.25	4.0	8.0	Q1
TPSM828223SILR	uSiP	SIL	10	3000	330.0	8.4	2.25	2.75	1.25	4.0	8.0	Q1
TPSM828224SILR	uSiP	SIL	10	3000	330.0	8.4	2.25	2.75	1.25	4.0	8.0	Q1
TPSM82822ASILR	uSiP	SIL	10	3000	330.0	8.4	2.25	2.75	1.25	4.0	8.0	Q1
TPSM82822SILR	uSiP	SIL	10	3000	330.0	8.4	2.25	2.75	1.25	4.0	8.0	Q1
TPSM82823ASILR	uSiP	SIL	10	3000	330.0	8.4	2.25	2.75	1.25	4.0	8.0	Q1
TPSM82823SILR	uSiP	SIL	10	3000	330.0	8.4	2.25	2.75	1.25	4.0	8.0	Q1

TAPE AND REEL BOX DIMENSIONS

*All dimensions are nominal

Device	Package Type	Package Drawing	Pins	SPQ	Length (mm)	Width (mm)	Height (mm)
TPSM828211SILR	uSiP	SIL	10	3000	383.0	353.0	58.0
TPSM828212SILR	uSiP	SIL	10	3000	383.0	353.0	58.0
TPSM828213SILR	uSiP	SIL	10	3000	383.0	353.0	58.0
TPSM828214SILR	uSiP	SIL	10	3000	383.0	353.0	58.0
TPSM82821ASILR	uSiP	SIL	10	3000	383.0	353.0	58.0
TPSM82821SILR	uSiP	SIL	10	3000	383.0	353.0	58.0
TPSM828221SILR	uSiP	SIL	10	3000	383.0	353.0	58.0
TPSM828222SILR	uSiP	SIL	10	3000	383.0	353.0	58.0
TPSM828223SILR	uSiP	SIL	10	3000	383.0	353.0	58.0
TPSM828224SILR	uSiP	SIL	10	3000	383.0	353.0	58.0
TPSM82822ASILR	uSiP	SIL	10	3000	383.0	353.0	58.0
TPSM82822SILR	uSiP	SIL	10	3000	383.0	353.0	58.0
TPSM82823ASILR	uSiP	SIL	10	3000	383.0	353.0	58.0
TPSM82823SILR	uSiP	SIL	10	3000	383.0	353.0	58.0

IMPORTANT NOTICE AND DISCLAIMER

TI PROVIDES TECHNICAL AND RELIABILITY DATA (INCLUDING DATA SHEETS), DESIGN RESOURCES (INCLUDING REFERENCE DESIGNS), APPLICATION OR OTHER DESIGN ADVICE, WEB TOOLS, SAFETY INFORMATION, AND OTHER RESOURCES "AS IS" AND WITH ALL FAULTS, AND DISCLAIMS ALL WARRANTIES, EXPRESS AND IMPLIED, INCLUDING WITHOUT LIMITATION ANY IMPLIED WARRANTIES OF MERCHANTABILITY, FITNESS FOR A PARTICULAR PURPOSE OR NON-INFRINGEMENT OF THIRD PARTY INTELLECTUAL PROPERTY RIGHTS.

These resources are intended for skilled developers designing with TI products. You are solely responsible for (1) selecting the appropriate TI products for your application, (2) designing, validating and testing your application, and (3) ensuring your application meets applicable standards, and any other safety, security, regulatory or other requirements.

These resources are subject to change without notice. TI grants you permission to use these resources only for development of an application that uses the TI products described in the resource. Other reproduction and display of these resources is prohibited. No license is granted to any other TI intellectual property right or to any third party intellectual property right. TI disclaims responsibility for, and you will fully indemnify TI and its representatives against, any claims, damages, costs, losses, and liabilities arising out of your use of these resources.

TI's products are provided subject to [TI's Terms of Sale](#) or other applicable terms available either on [ti.com](https://www.ti.com) or provided in conjunction with such TI products. TI's provision of these resources does not expand or otherwise alter TI's applicable warranties or warranty disclaimers for TI products.

TI objects to and rejects any additional or different terms you may have proposed.

Mailing Address: Texas Instruments, Post Office Box 655303, Dallas, Texas 75265

Copyright © 2025, Texas Instruments Incorporated