

TPS7A20 300mA, Ultra-Low-Noise, Low-I_Q, High PSRR LDO

1 Features

- Low output voltage noise: $7\mu\text{V}_{\text{RMS}}$
 - No noise-bypass capacitor required
- High PSRR: 95dB at 1kHz
- Very low I_Q: 6.5μA
- Input voltage range: 1.6V to 6.0V
- Output voltage range: 0.8V to 5.5V
- Output voltage tolerance: ±1.5% (max)
- Very low dropout:
 - 140mV (max) at 300mA (V_{OUT} = 3.3V)
 - 145mV (max) at 300mA (V_{OUT} = 3.3V, DBV)
- Low inrush current
- Smart enable pulldown
- Stable with 1μF minimum ceramic output capacitor
- Packages:
 - 1mm × 1mm X2SON (DQN)
 - 0.616mm × 0.616mm DSBGA (YCK)
 - 0.612mm × 0.612mm DSBGA (YCJ)
 - 2.9mm × 2.8mm SOT23-5 (DBV)

2 Applications

- [Smartphones](#) and [tablets](#)
- [IP network cameras](#)
- [Portable medical equipment](#)
- [Smart meters](#) and [field transmitters](#)
- [Motor drives](#)
- [Wearables](#)



Application Schematic

3 Description

The TPS7A20 is an ultra-small, low-dropout (LDO) linear regulator that can source 300mA of output current. The TPS7A20 is designed to provide low noise, high PSRR, and excellent load and line transient performance that can meet the requirements of RF and other sensitive analog circuits. Using innovative design techniques, the TPS7A20 offers an ultra-low noise performance without the addition of a noise bypass capacitor. The TPS7A20 also provides the advantage of low quiescent current, which can be ideal for battery-powered applications. With an input voltage range of 1.6V to 6.0V and an output range of 0.8V to 5.5V, the TPS7A20 can be used for a wide variety of applications. The device uses a precision reference circuit to provide a maximum accuracy of 1.5% over load, line, and temperature variations.

The TPS7A20 features an internal soft-start to lower the inrush current, thus minimizing the input voltage drop during start up. The device is stable with small ceramic capacitors, allowing for a small overall solution size.

The TPS7A20 has a smart enable input circuit with an internally controlled pulldown resistor that keeps the LDO disabled even when the EN pin is left floating and helps eliminate the external components used to pulldown the EN pin.

Package Information

PART NUMBER	PACKAGE ⁽¹⁾	PACKAGE SIZE ⁽²⁾
TPS7A20	DQN (X2SON, 4)	1mm × 1mm
	YCJ (DSBGA, 4)	0.612mm × 0.612mm
	YCK (DSBGA, 4)	0.616mm × 0.616mm
	DBV (SOT-23, 5)	2.9mm × 2.8mm

- (1) For more information, see the [Mechanical, Packaging, and Orderable Information](#).
- (2) The package size (length × width) is a nominal value and includes pins, where applicable.



Table of Contents

1 Features	1	7 Application and Implementation	27
2 Applications	1	7.1 Application Information.....	27
3 Description	1	7.2 Typical Application.....	30
4 Pin Configuration and Functions	3	7.3 Power Supply Recommendations.....	31
5 Specifications	5	7.4 Layout.....	31
5.1 Absolute Maximum Ratings.....	5	8 Device and Documentation Support	33
5.2 ESD Ratings.....	5	8.1 Device Support.....	33
5.3 Recommended Operating Conditions.....	5	8.2 Receiving Notification of Documentation Updates...33	
5.4 Thermal Information.....	6	8.3 Support Resources.....	33
5.5 Electrical Characteristics.....	6	8.4 Trademarks.....	33
5.6 Switching Characteristics.....	7	8.5 Electrostatic Discharge Caution.....	33
5.7 Typical Characteristics.....	8	8.6 Glossary.....	33
6 Detailed Description	23	9 Revision History	34
6.1 Overview.....	23	10 Mechanical, Packaging, and Orderable	
6.2 Functional Block Diagram.....	23	Information	34
6.3 Feature Description.....	24	10.1 Mechanical Data.....	35
6.4 Device Functional Modes.....	26		

4 Pin Configuration and Functions

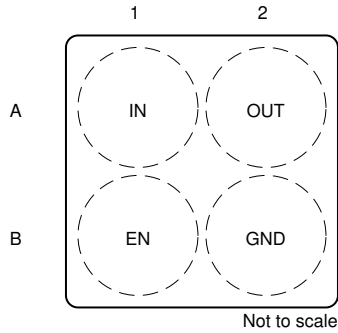

Figure 4-1. YCJ and YCK Packages, 4-Pin DSBGA (Top View)

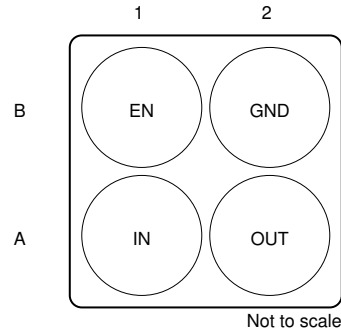

Figure 4-2. YCJ and YCK Packages, 4-Pin DSBGA (Bottom View)

Pin Functions: DSBGA

PIN		I/O	DESCRIPTION
NO.	NAME		
A1	IN	I	Input voltage supply. For best transient response and to minimize input impedance, use the nominal value or larger capacitor from IN to ground as listed in the <i>Recommended Operating Conditions</i> table. Place the input capacitor as close to the IN and GND pins of the device as possible.
A2	OUT	O	Regulated output voltage. A low equivalent series resistance (ESR) capacitor is required from OUT to ground for stability. For best transient response, use the nominal recommended value or larger capacitor listed in the <i>Recommended Operating Conditions</i> table. Place the output capacitor as close to the OUT and GND pins of the device as possible.
B1	EN	I	Enable input. A low voltage ($< V_{EN(LOW)}$) on this input turns the regulator off and discharges the output pin to GND. A high voltage ($> V_{EN(HI)}$) on this pin enables the regulator output. This pin has an internal 500k Ω pulldown resistor to hold the regulator off by default. When $V_{EN} > V_{EN(HI)}$, the 500k Ω pulldown is disconnected to reduce input current.
B2	GND	—	Common ground.

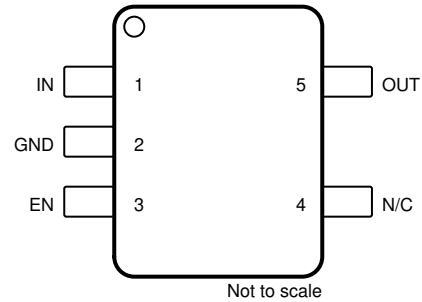
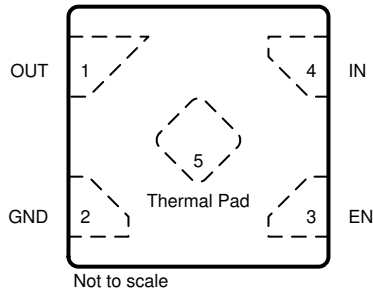

Figure 4-3. DQN Package, 4-Pin X2SON (Top View)

Figure 4-4. DBV Package, 5-Pin SOT-23 (Top View)

Pin Functions: X2SON, SOT-23

NAME	PIN		I/O	DESCRIPTION
	X2SON	SOT-23		
IN	4	1	I	Input voltage supply. For best transient response and to minimize input impedance, use the nominal value or larger capacitor from IN to ground as listed in the <i>Recommended Operating Conditions</i> table. Place the input capacitor as close to the IN and GND pins of the device as possible.
OUT	1	5	O	Regulated output voltage. A low equivalent series resistance (ESR) capacitor is required from OUT to ground for stability. For best transient response, use the nominal recommended value or larger capacitor listed in the <i>Recommended Operating Conditions</i> table. Place the output capacitor as close to the OUT and GND pins of the device as possible. An internal 150Ω (typical) pulldown resistor prevents a charge from remaining on V_{OUT} when the regulator is in shutdown mode ($V_{EN} < V_{EN(Low)}$).
EN	3	3	I	Enable input. A low voltage ($< V_{EN(Low)}$) on this pin turns the regulator off and discharges the output pin to GND. A high voltage ($> V_{EN(Hi)}$) on this pin enables the regulator output. This pin has an internal 500kΩ pulldown resistor to hold the regulator off by default. When $V_{EN} > V_{EN(Hi)}$, the 500kΩ pulldown is disconnected to reduce input current.
GND	2	2	—	Common ground.
N/C	—	4	—	No internal electrical connection.
Thermal Pad	5	—	—	Thermal pad for the X2SON package. Connect this pad to GND or leave floating. Do not connect to any potential other than GND. Connect the thermal pad to a large-area ground plane for best thermal performance.

5 Specifications

5.1 Absolute Maximum Ratings

over operating free-air temperature range (unless otherwise noted)^{(1) (3)}

		MIN	MAX	UNIT
Voltage	V _{IN}	-0.3	6.5	V
	V _{OUT}	-0.3	6.5 or V _{IN} + 0.3 ⁽²⁾	
	V _{EN}	-0.3	6.5	
Current	Maximum output ⁽⁴⁾	Internally limited		A
Temperature	Operating junction, T _J	-40	150	°C
	Storage, T _{stg}	-65	150	°C

- (1) Stresses beyond those listed under *Absolute Maximum Ratings* may cause permanent damage to the device. These are stress ratings only, and functional operation of the device at these or any other conditions beyond those indicated under Recommended Operating Conditions is not implied. Exposure to absolute-maximum-rated conditions for extended periods may affect device reliability.
- (2) The maximum value of V_{OUT} is the lesser of 6.5 V or (V_{IN} + 0.3 V).
- (3) All voltages are with respect to the GND pin.
- (4) Internal thermal shutdown circuitry protects the device from permanent damage.

5.2 ESD Ratings

			VALUE	UNIT
V _(ESD)	Electrostatic discharge	Human-body model (HBM), per ANSI/ESDA/JEDEC JS-001 ⁽¹⁾	±2000	V
		Charged-device model (CDM), per JEDEC specification JESD22-C101 ⁽²⁾	±750	

- (1) JEDEC document JEP155 states that 500-V HBM allows safemanufacturing with a standard ESD control process.
- (2) JEDEC document JEP157 states that 250-V CDM allows safemanufacturing with a standard ESD control process.

5.3 Recommended Operating Conditions

over operating free-air temperature range (unless otherwise noted)⁽¹⁾

		MIN	NOM	MAX	UNIT
V _{IN}	Input supply voltage	1.6		6.0	V
V _{EN}	Enable input voltage	0		6.0	V
V _{OUT}	Nominal output voltage range	0.8		5.5	V
I _{OUT}	Output current	0		300	mA
C _{IN}	Input capacitor ⁽²⁾		1		μF
C _{OUT}	Output capacitor ⁽³⁾	1		200	μF
ESR	Output capacitor effective series resistance			100	mΩ
T _J	Operating junction temperature	-40		125	°C

- (1) All voltages are with respect to GND.
- (2) An input capacitor is not required for LDO stability. However, an input capacitor with an effective value of 0.47 μF minimum is recommended to counteract the effect of source resistance and inductance, which may in some cases cause symptoms of system-level instability such as ringing or oscillation, especially in the presence of load transients.
- (3) Effective output capacitance of 0.47 μF minimum and 200 μF maximum is required for stability.

5.4 Thermal Information

THERMAL METRIC ⁽¹⁾		TPS7A20				UNIT
		DBV (SOT-23)	DQN (X2SON)	YCJ (DSBGA)	YCK (DSBGA)	
		5 PINS	4 PINS	4 PINS	4 PINS	
R _{θJA}	Junction-to-ambient thermal resistance	187.1	166.1	199.6	201.4	°C/W
R _{θJC(top)}	Junction-to-case (top) thermal resistance	85.5	103.6	2.8	2.8	°C/W
R _{θJB}	Junction-to-board thermal resistance	54.4	110.6	67.5	69.3	°C/W
ψ _{JT}	Junction-to-top characterization parameter	27.1	3.0	1.4	1.4	°C/W
ψ _{JB}	Junction-to-board characterization parameter	54.1	103.3	67.4	69.2	°C/W
R _{θJC(bot)}	Junction-to-case (bottom) thermal resistance	N/A	98.8	N/A	N/A	°C/W

(1) For more information about traditional and new thermal metrics, see the [Semiconductor and IC Package Thermal Metrics](#) application report.

5.5 Electrical Characteristics

at operating temperature range ($T_J = -40^{\circ}\text{C}$ to $+125^{\circ}\text{C}$), $V_{IN} = V_{OUT(NOM)} + 0.3\text{ V}$ or 1.6 V , whichever is greater, $V_{EN} = 1.0\text{ V}$, $I_{OUT} = 1\text{ mA}$, $C_{IN} = 1\text{ }\mu\text{F}$, $C_{OUT} = 1\text{ }\mu\text{F}$ (unless otherwise noted); all typical values are at $T_J = 25^{\circ}\text{C}$

PARAMETER		TEST CONDITIONS	MIN	TYP	MAX	UNIT
ΔV _{OUT}	Output voltage tolerance	$V_{IN} = (V_{OUT(NOM)} + 0.3\text{ V})$ to 6.0 V , $I_{OUT} = 1\text{ mA}$ to 300 mA , $V_{OUT} \geq 1.85\text{ V}$ (DQN, YCJ, YCK packages)	-1.5		1.5	%
		$V_{IN} = (V_{OUT(NOM)} + 0.3\text{ V})$ to 6.0 V , $I_{OUT} = 1\text{ mA}$ to 300 mA , $V_{OUT} \geq 2.8\text{ V}$ (DBV package)	-1.5		1.5	
		$V_{IN} = (V_{OUT(NOM)} + 0.5\text{ V})$ to 6.0 V , $I_{OUT} = 1\text{ mA}$ to 300 mA , $V_{OUT} < 1.85\text{ V}$ (DQN, YCJ, YCK packages)	-30		30	mV
		$V_{IN} = (V_{OUT(NOM)} + 0.3\text{ V})$ to 6.0 V , $I_{OUT} = 1\text{ mA}$ to 300 mA , $V_{OUT} < 2.8\text{ V}$ (DBV package)	-40		40	
ΔV _{OUT}	Line regulation	$V_{IN} = (V_{OUT(NOM)} + 0.3\text{ V})$ to 6.0 V , $I_{OUT} = 1\text{ mA}$		0.03		%/V
ΔV _{OUT}	Load regulation	$I_{OUT} = 1\text{ mA}$ to 300 mA (DQN, YCJ, YCK packages)		13		mV
		$I_{OUT} = 1\text{ mA}$ to 300 mA (DBV package)		19		
I _{GND}	Quiescent ground current	$V_{EN} = V_{IN} = 6\text{ V}$, $I_{OUT} = 0\text{ mA}$	$T_J = 25^{\circ}\text{C}$	6.5	8.5	μA
			$T_J = -40^{\circ}\text{C}$ to 85°C		10	
			$T_J = -40^{\circ}\text{C}$ to 125°C		15	
		$V_{EN} = V_{IN} = 6\text{ V}$, $I_{OUT} = 300\text{ mA}$		2000		
I _{SHDN}	Shutdown ground current	$V_{EN} = 0\text{ V}$ (disabled), $V_{IN} = 6.0\text{ V}$, $T_J = 25^{\circ}\text{C}$		0.07	0.2	μA
I _{GND(DO)}	I _{GND} in dropout	$V_{IN} \leq V_{OUT(NOM)}$, $I_{OUT} = 0\text{ mA}$, $V_{EN} = V_{IN}$		6.5	15	μA
V _{DO}	Dropout voltage	$I_{OUT} = 300\text{ mA}$, $V_{OUT} = 95\% \times V_{OUT(NOM)}$, (DQN, YCJ, YCK packages unless otherwise noted)	$0.8\text{ V} \leq V_{OUT} < 1.0\text{ V}^{(1)}$		690	mV
			$1.0\text{ V} \leq V_{OUT} < 1.2\text{ V}^{(1)}$		490	
			$1.2\text{ V} \leq V_{OUT} < 1.5\text{ V}^{(1)}$		355	
			$1.5\text{ V} \leq V_{OUT} < 2.5\text{ V}$		200	
			$1.5\text{ V} \leq V_{OUT} < 2.5\text{ V}$ (DBV)		205	
			$2.5\text{ V} \leq V_{OUT} < 5.5\text{ V}$		140	
			$2.5\text{ V} \leq V_{OUT} < 5.5\text{ V}$ (DBV)		145	

5.5 Electrical Characteristics (continued)

at operating temperature range ($T_J = -40^\circ\text{C}$ to $+125^\circ\text{C}$), $V_{IN} = V_{OUT(NOM)} + 0.3\text{ V}$ or 1.6 V , whichever is greater, $V_{EN} = 1.0\text{ V}$, $I_{OUT} = 1\text{ mA}$, $C_{IN} = 1\text{ }\mu\text{F}$, $C_{OUT} = 1\text{ }\mu\text{F}$ (unless otherwise noted); all typical values are at $T_J = 25^\circ\text{C}$

PARAMETER		TEST CONDITIONS		MIN	TYP	MAX	UNIT
I_{CL}	Output current limit	$V_{OUT} = 0.9 \times V_{OUT(NOM)}$, $V_{IN} = V_{OUT(NOM)} + 0.5\text{ V}$	$V_{OUT} < 1.5\text{ V}$ (YCK, YCK packages)	360	520	770	mA
		$V_{OUT} = 0.9 \times V_{OUT(NOM)}$, $V_{IN} = V_{OUT(NOM)} + 0.5\text{ V}$	$V_{OUT} < 1.5\text{ V}$ (DQN package)	360	520	730	
		$V_{OUT} = V_{OUT(NOM)} - 150\text{ mV}$, $V_{IN} = V_{OUT(NOM)} + 0.5\text{ V}$	$V_{OUT} < 1.5\text{ V}$ (DBV package)	360	520	730	
		$V_{OUT} = 0.9 \times V_{OUT(NOM)}$, $V_{IN} = V_{OUT(NOM)} + 0.3\text{ V}$	$V_{OUT} \geq 1.5\text{ V}$ (YCK, YCK packages)	360	520	770	
		$V_{OUT} = 0.9 \times V_{OUT(NOM)}$, $V_{IN} = V_{OUT(NOM)} + 0.3\text{ V}$	$V_{OUT} \geq 1.5\text{ V}$ (DQN package)	360	520	730	
I_{SC}	Short-circuit current limit	$V_{OUT} = 0\text{ V}$			160		mA
$PSRR$	Power-supply rejection ratio	$I_{OUT} = 20\text{ mA}$, $V_{IN} = V_{OUT} + 1.0\text{ V}$	$f = 100\text{ Hz}$		95		dB
			$f = 1\text{ kHz}$		95		
			$f = 10\text{ kHz}$		75		
			$f = 100\text{ kHz}$		75		
			$f = 1\text{ MHz}$		45		
		$I_{OUT} = 300\text{ mA}$, $V_{IN} = V_{OUT} + 1.0\text{ V}$	$f = 100\text{ Hz}$		65		
			$f = 1\text{ kHz}$		92		
			$f = 10\text{ kHz}$		75		
			$f = 100\text{ kHz}$		60		
			$f = 1\text{ MHz}$		40		
V_N	Output noise voltage	BW = 10 Hz to 100 kHz, $V_{OUT} = 2.8\text{ V}$	$I_{OUT} = 300\text{ mA}$		7		μV_{RMS}
			$I_{OUT} = 1\text{ mA}$		10		
$R_{PULLDOWN}$	Output automatic discharge pulldown resistance	$V_{EN} < V_{EN(LOW)}$ (output disabled), $V_{IN} = 3.1\text{ V}$			150		Ω
T_{SD}	Thermal shutdown	T_J rising			165		$^\circ\text{C}$
		T_J falling			140		
$V_{EN(LOW)}$	Low input threshold	$V_{IN} = 1.6\text{ V}$ to 6.0 V , V_{EN} falling until the output is disabled				0.3	V
$V_{EN(HI)}$	High input threshold	$V_{IN} = 1.6\text{ V}$ to 6.0 V , V_{EN} rising until the output is enabled		0.9			V
V_{UVLO}	UVLO threshold	V_{IN} rising (YCK and YCK packages)		1.11	1.35	1.59	V
		V_{IN} rising (DBV and DQN packages)		1.17	1.35	1.59	
		V_{IN} falling (YCK and YCK packages)		1.05	1.3	1.55	
		V_{IN} falling (DBV and DQN packages)		1.11	1.3	1.55	
$V_{UVLO(HYST)}$	UVLO hysteresis				50		mV
I_{EN}	EN input leakage current	$V_{EN} = 6.0\text{ V}$ and $V_{IN} = 6.0\text{ V}$			90	250	nA
$R_{EN(PULL-DOWN)}$	Smart enable pulldown resistor	$V_{EN} = 0.25\text{ V}$			500		K Ω

(1) Design simulation data only

5.6 Switching Characteristics

at operating temperature range ($T_J = -40^\circ\text{C}$ to $+125^\circ\text{C}$), $V_{IN} = V_{OUT(NOM)} + 0.3\text{ V}$ or 1.6 V , whichever is greater, $V_{EN} = 1.0\text{ V}$, $I_{OUT} = 1\text{ mA}$, $C_{IN} = 1\text{ }\mu\text{F}$, $C_{OUT} = 1\text{ }\mu\text{F}$ (unless otherwise noted); all typical values are at $T_J = 25^\circ\text{C}$

PARAMETER		TEST CONDITIONS		MIN	TYP	MAX	UNIT
t_{STR}	Start-up time	From $V_{EN} > V_{EN(HI)}$ to $V_{OUT} = 95\%$ of $V_{OUT(NOM)}$			750	1150	μs

5.7 Typical Characteristics

$V_{IN} = V_{OUT(NOM)} + 0.3\text{ V}$ or 1.6 V (whichever is greater), $V_{OUT} = 2.8\text{ V}$, $I_{OUT} = 1\text{ mA}$, $C_{IN} = 1\text{ }\mu\text{F}$, $C_{OUT} = 1\text{ }\mu\text{F}$, and $T_A = 25^\circ\text{C}$ (unless otherwise noted)

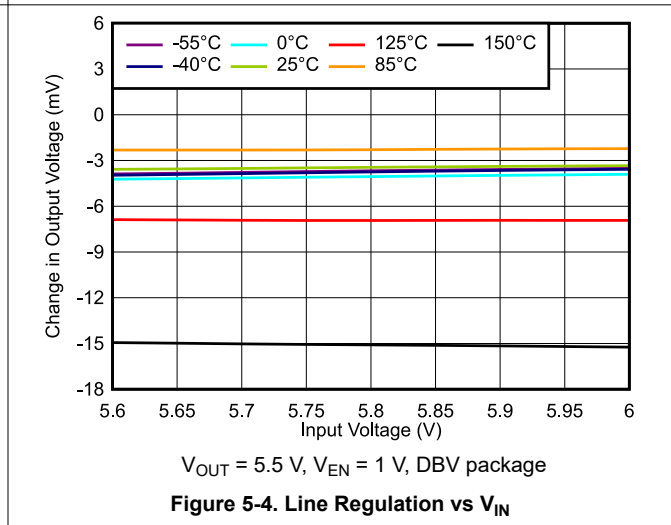
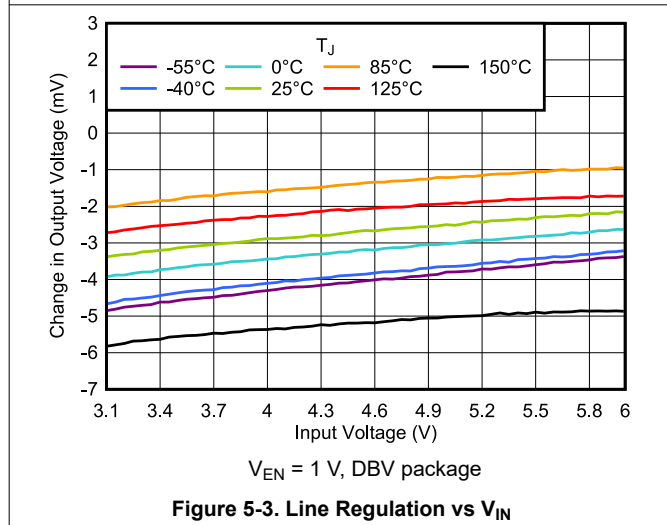
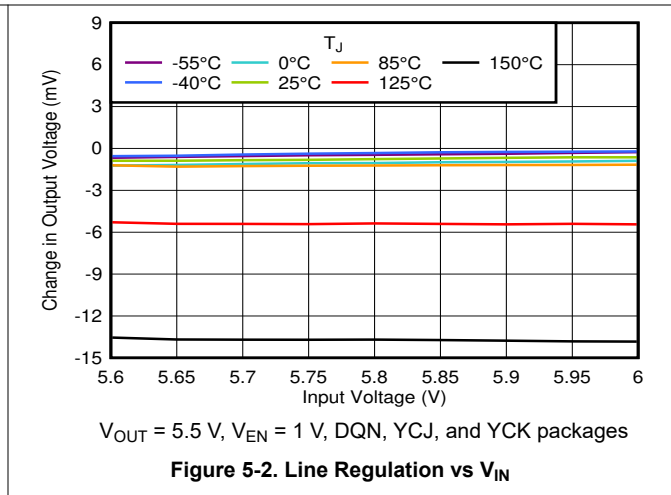
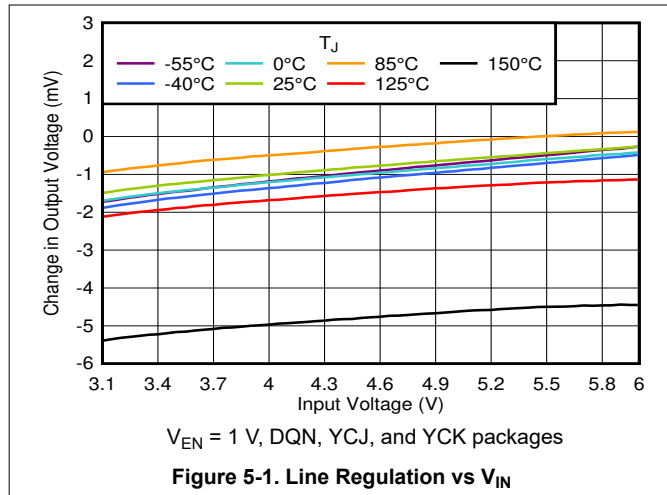

5.7 Typical Characteristics (continued)

$V_{IN} = V_{OUT(NOM)} + 0.3\text{ V}$ or 1.6 V (whichever is greater), $V_{OUT} = 2.8\text{ V}$, $I_{OUT} = 1\text{ mA}$, $C_{IN} = 1\text{ }\mu\text{F}$, $C_{OUT} = 1\text{ }\mu\text{F}$, and $T_A = 25^\circ\text{C}$ (unless otherwise noted)



5.7 Typical Characteristics (continued)

$V_{IN} = V_{OUT(NOM)} + 0.3\text{ V}$ or 1.6 V (whichever is greater), $V_{OUT} = 2.8\text{ V}$, $I_{OUT} = 1\text{ mA}$, $C_{IN} = 1\text{ }\mu\text{F}$, $C_{OUT} = 1\text{ }\mu\text{F}$, and $T_A = 25^\circ\text{C}$ (unless otherwise noted)



$V_{EN} = 1\text{ V}$, DQN, YCJ, and YCK packages

Figure 5-13. Output Voltage Accuracy vs I_{OUT}



$V_{EN} = 1\text{ V}$, DQN, YCJ, and YCK packages

Figure 5-14. Output Voltage Accuracy vs I_{OUT}

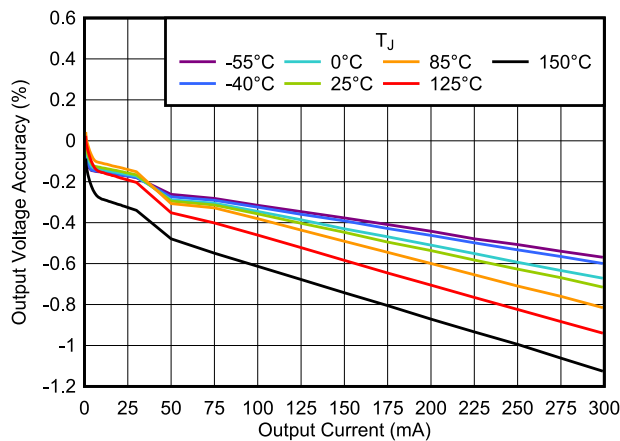

$V_{EN} = 1\text{ V}$, DBV package

Figure 5-15. Output Voltage Accuracy vs I_{OUT}

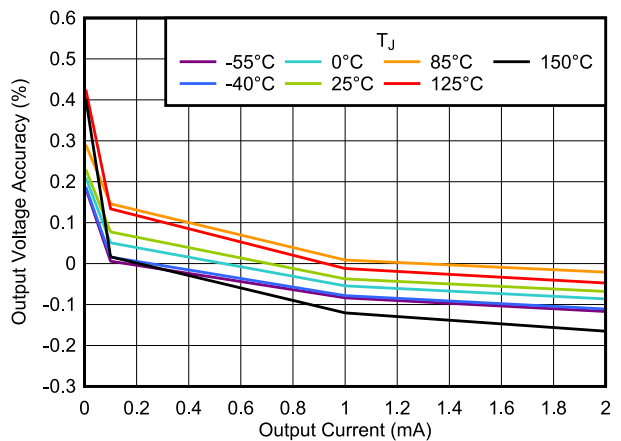

$V_{EN} = 1\text{ V}$, DBV package

Figure 5-16. Output Voltage Accuracy vs I_{OUT}



$V_{OUT} = 5.5\text{ V}$, $V_{EN} = 1\text{ V}$, DQN, YCJ, and YCK packages

Figure 5-17. Output Voltage Accuracy vs I_{OUT}



$V_{OUT} = 5.5\text{ V}$, $V_{EN} = 1\text{ V}$, DQN, YCJ, and YCK packages

Figure 5-18. Output Voltage Accuracy vs I_{OUT}

5.7 Typical Characteristics (continued)

$V_{IN} = V_{OUT(NOM)} + 0.3\text{ V}$ or 1.6 V (whichever is greater), $V_{OUT} = 2.8\text{ V}$, $I_{OUT} = 1\text{ mA}$, $C_{IN} = 1\text{ }\mu\text{F}$, $C_{OUT} = 1\text{ }\mu\text{F}$, and $T_A = 25^\circ\text{C}$ (unless otherwise noted)



5.7 Typical Characteristics (continued)

$V_{IN} = V_{OUT(NOM)} + 0.3\text{ V}$ or 1.6 V (whichever is greater), $V_{OUT} = 2.8\text{ V}$, $I_{OUT} = 1\text{ mA}$, $C_{IN} = 1\text{ }\mu\text{F}$, $C_{OUT} = 1\text{ }\mu\text{F}$, and $T_A = 25^\circ\text{C}$ (unless otherwise noted)

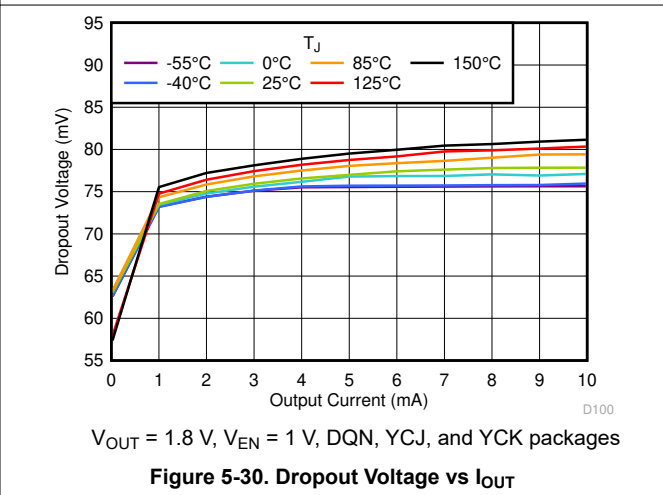
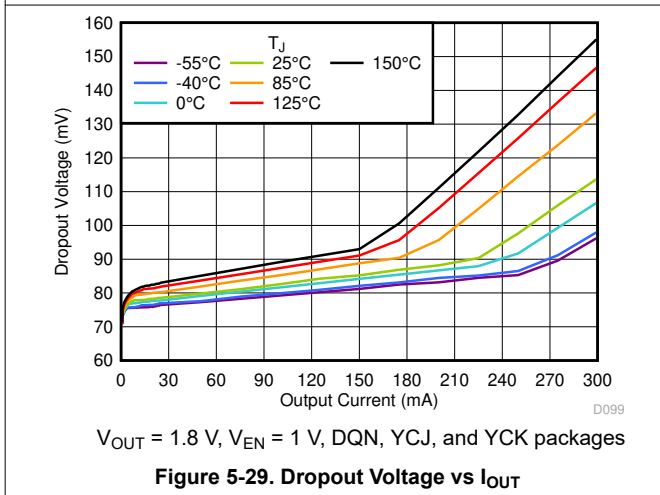
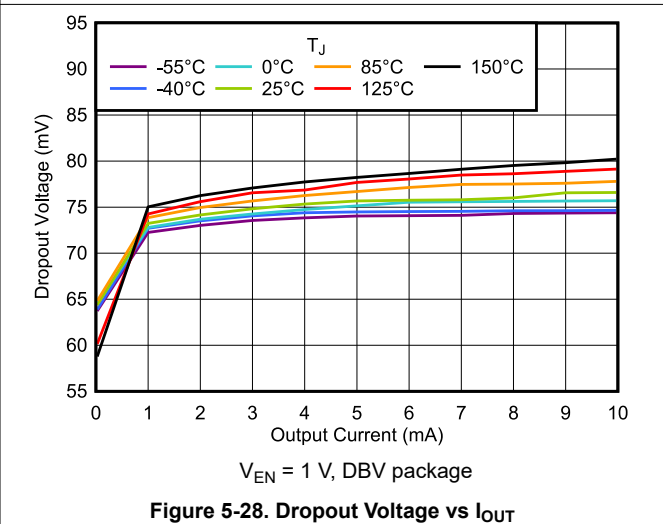
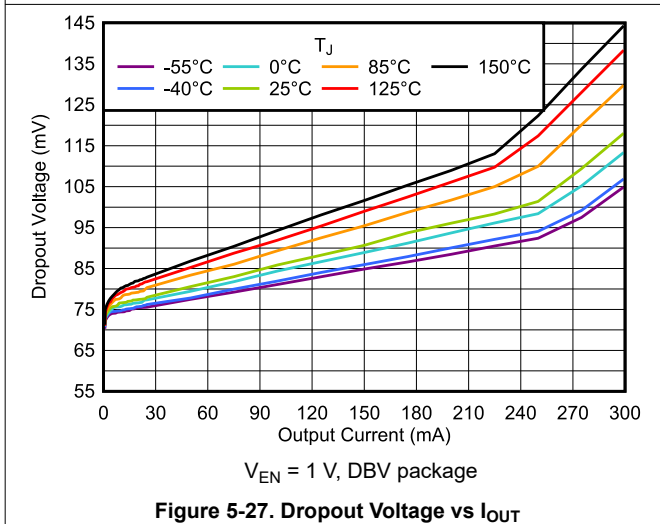
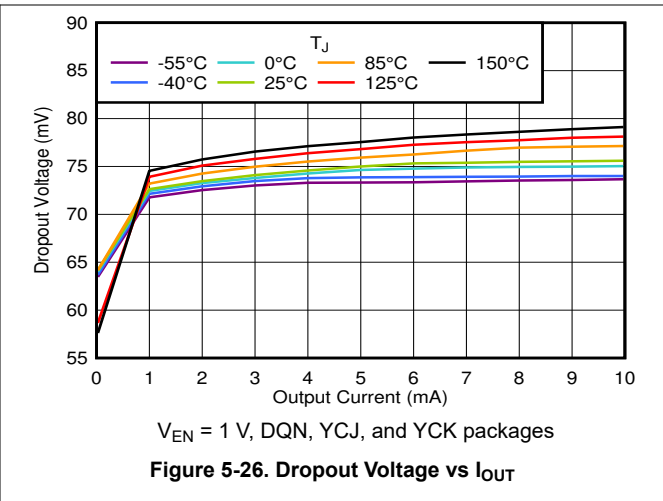
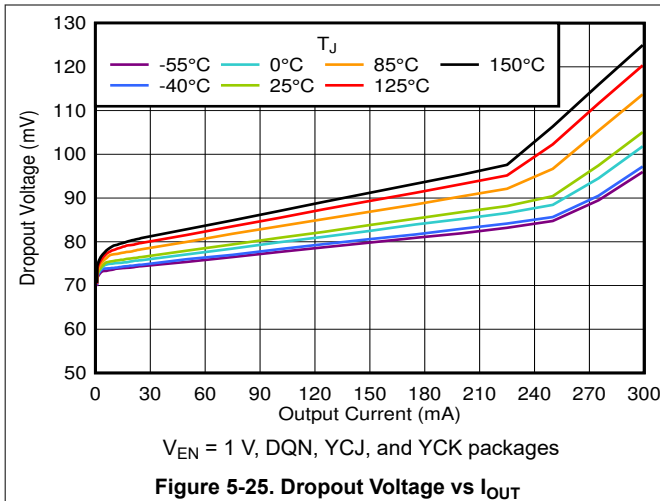

5.7 Typical Characteristics (continued)

$V_{IN} = V_{OUT(NOM)} + 0.3\text{ V}$ or 1.6 V (whichever is greater), $V_{OUT} = 2.8\text{ V}$, $I_{OUT} = 1\text{ mA}$, $C_{IN} = 1\text{ }\mu\text{F}$, $C_{OUT} = 1\text{ }\mu\text{F}$, and $T_A = 25^\circ\text{C}$ (unless otherwise noted)

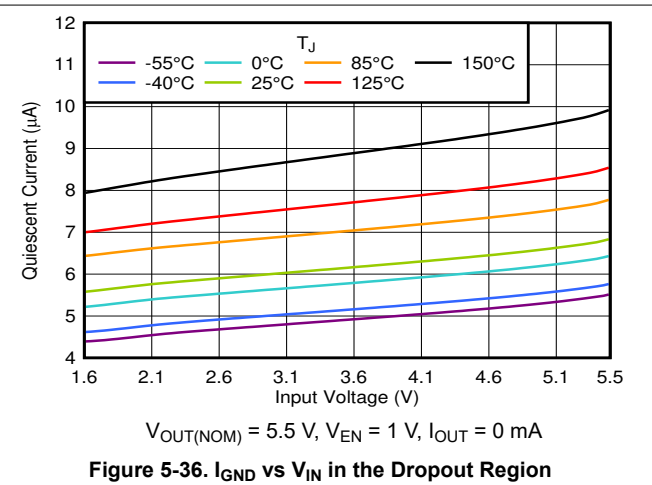
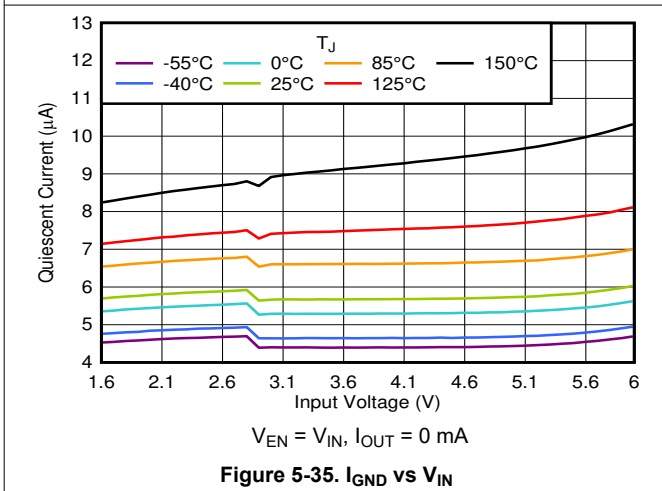

5.7 Typical Characteristics (continued)

$V_{IN} = V_{OUT(NOM)} + 0.3\text{ V}$ or 1.6 V (whichever is greater), $V_{OUT} = 2.8\text{ V}$, $I_{OUT} = 1\text{ mA}$, $C_{IN} = 1\text{ }\mu\text{F}$, $C_{OUT} = 1\text{ }\mu\text{F}$, and $T_A = 25^\circ\text{C}$ (unless otherwise noted)

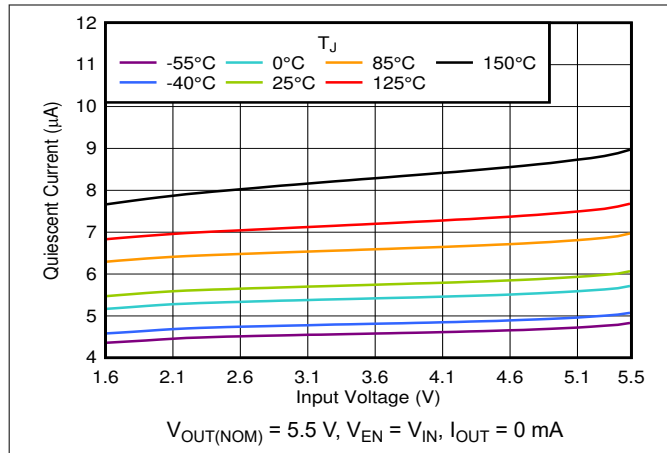

Figure 5-37. I_{GND} vs V_{IN} in the Dropout Region

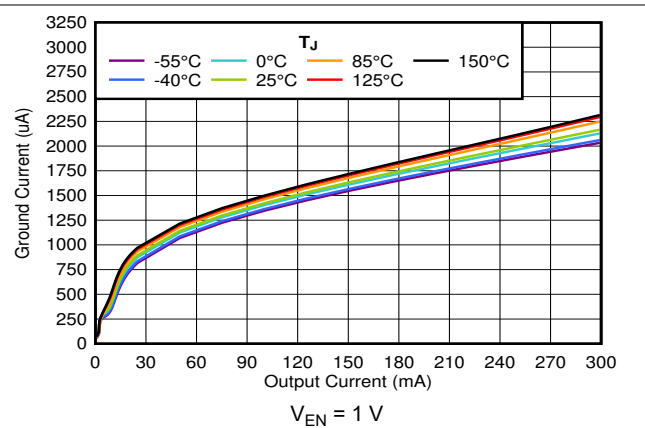

Figure 5-38. I_{GND} vs I_{OUT}

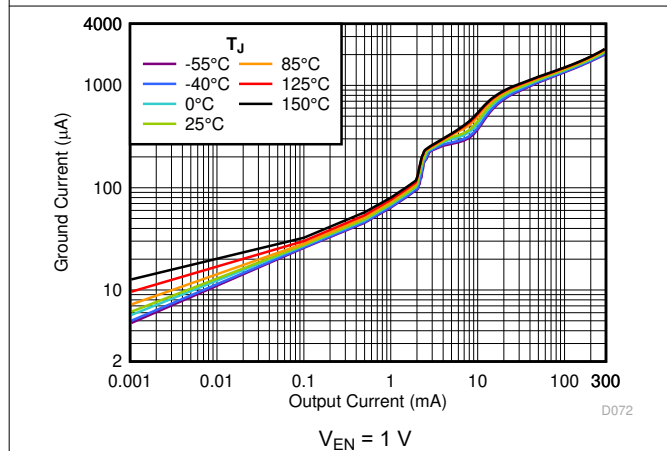

Figure 5-39. I_{GND} vs I_{OUT}

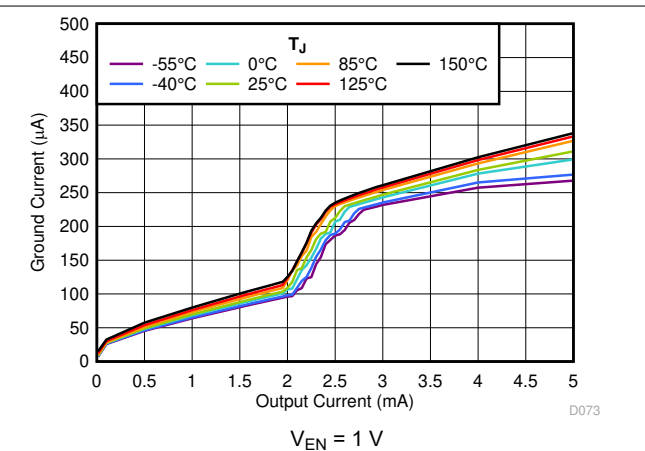

Figure 5-40. I_{GND} vs I_{OUT}

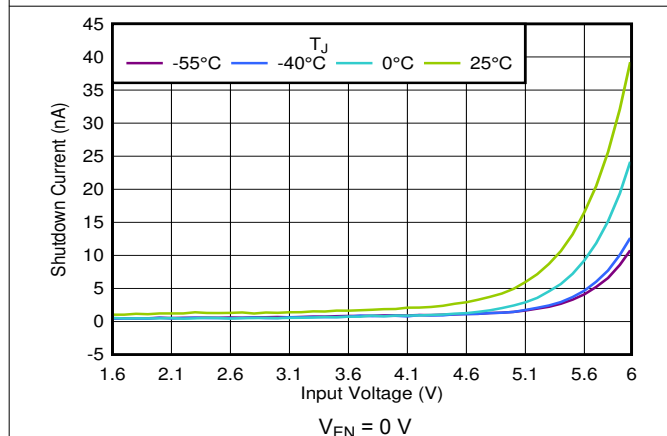

Figure 5-41. Shutdown Current vs V_{IN}

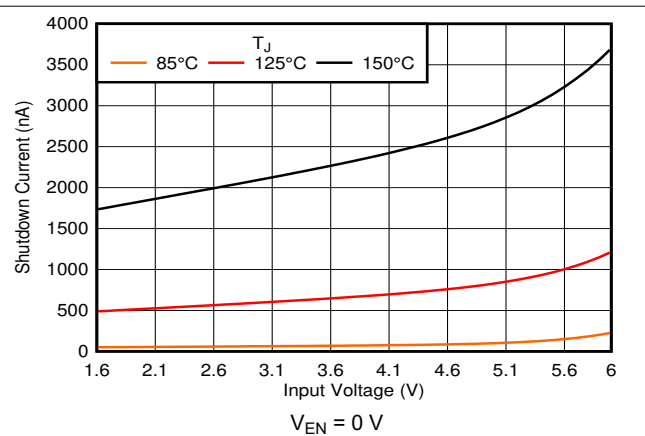

Figure 5-42. Shutdown Current vs V_{IN}

5.7 Typical Characteristics (continued)

$V_{IN} = V_{OUT(NOM)} + 0.3\text{ V}$ or 1.6 V (whichever is greater), $V_{OUT} = 2.8\text{ V}$, $I_{OUT} = 1\text{ mA}$, $C_{IN} = 1\text{ }\mu\text{F}$, $C_{OUT} = 1\text{ }\mu\text{F}$, and $T_A = 25^\circ\text{C}$ (unless otherwise noted)



5.7 Typical Characteristics (continued)

$V_{IN} = V_{OUT(NOM)} + 0.3\text{ V}$ or 1.6 V (whichever is greater), $V_{OUT} = 2.8\text{ V}$, $I_{OUT} = 1\text{ mA}$, $C_{IN} = 1\text{ }\mu\text{F}$, $C_{OUT} = 1\text{ }\mu\text{F}$, and $T_A = 25^\circ\text{C}$ (unless otherwise noted)

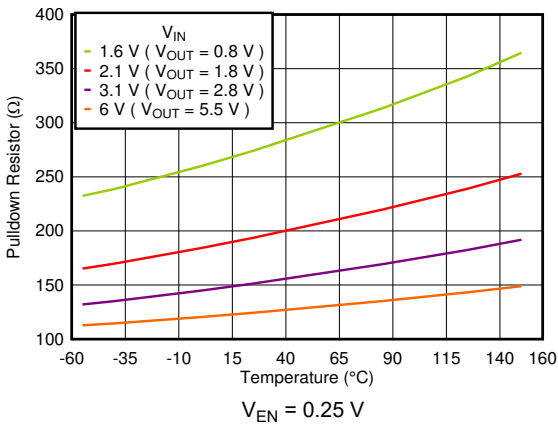

Figure 5-49. Output Pulldown Resistor vs Temperature

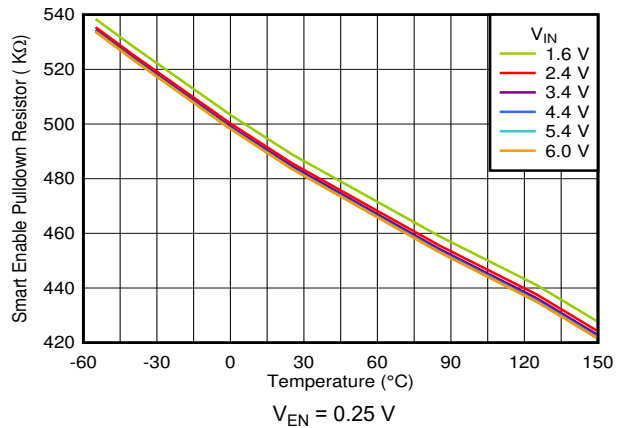
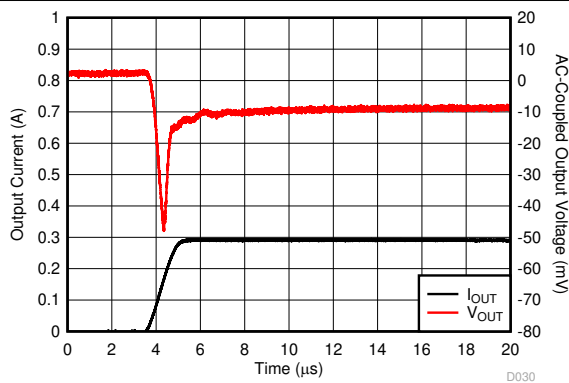

Figure 5-50. Smart Enable Pulldown Resistor vs Temperature and V_{IN}



$I_{OUT} = 1\text{ mA to }300\text{ mA}$, $t_{RISING} = 1\text{ }\mu\text{s}$

Figure 5-51. Load Transient



$I_{OUT} = 300\text{ mA to }1\text{ mA}$, $t_{FALLING} = 1\text{ }\mu\text{s}$

Figure 5-52. Load Transient

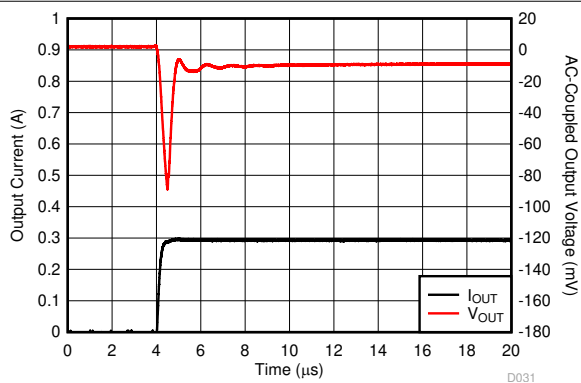

$I_{OUT} = 1\text{ mA to }300\text{ mA}$, $t_{RISING} = 200\text{ ns}$

Figure 5-53. Load Transient



$I_{OUT} = 300\text{ mA to }1\text{ mA}$, $t_{FALLING} = 200\text{ ns}$

Figure 5-54. Load Transient

5.7 Typical Characteristics (continued)

$V_{IN} = V_{OUT(NOM)} + 0.3\text{ V}$ or 1.6 V (whichever is greater), $V_{OUT} = 2.8\text{ V}$, $I_{OUT} = 1\text{ mA}$, $C_{IN} = 1\text{ }\mu\text{F}$, $C_{OUT} = 1\text{ }\mu\text{F}$, and $T_A = 25^\circ\text{C}$ (unless otherwise noted)



$I_{OUT} = 0\text{ mA to } 300\text{ mA}$, $t_{RISING} = 1\text{ }\mu\text{s}$

Figure 5-55. Load Transient



$I_{OUT} = 300\text{ mA to } 0\text{ mA}$, $t_{FALLING} = 1\text{ }\mu\text{s}$

Figure 5-56. Load Transient



$I_{OUT} = 0\text{ mA to } 300\text{ mA}$, $t_{RISING} = 200\text{ ns}$

Figure 5-57. Load Transient



$I_{OUT} = 300\text{ mA to } 0\text{ mA}$, $t_{FALLING} = 200\text{ ns}$

Figure 5-58. Load Transient



$V_{IN} = 3.1\text{ V} \rightarrow 4.1\text{ V} \rightarrow 3.1\text{ V}$, $V_{IN} t_{RISING} = 5\text{ }\mu\text{s}$, $I_{OUT} = 1\text{ mA}$

Figure 5-59. Line Transient



$V_{IN} = 3.1\text{ V} \rightarrow 4.1\text{ V} \rightarrow 3.1\text{ V}$, $V_{IN} t_{RISING} = 5\text{ }\mu\text{s}$, $I_{OUT} = 300\text{ mA}$

Figure 5-60. Line Transient

5.7 Typical Characteristics (continued)

$V_{IN} = V_{OUT(NOM)} + 0.3\text{ V}$ or 1.6 V (whichever is greater), $V_{OUT} = 2.8\text{ V}$, $I_{OUT} = 1\text{ mA}$, $C_{IN} = 1\text{ }\mu\text{F}$, $C_{OUT} = 1\text{ }\mu\text{F}$, and $T_A = 25^\circ\text{C}$ (unless otherwise noted)



$I_{OUT} = 20\text{ mA}$
Figure 5-61. PSRR vs V_{IN} vs Frequency and V_{IN}



$I_{OUT} = 300\text{ mA}$
Figure 5-62. PSRR vs Frequency and V_{IN}



Figure 5-63. PSRR vs Frequency and I_{OUT}



$I_{OUT} = 20\text{ mA}$
Figure 5-64. PSRR vs Frequency and C_{OUT}

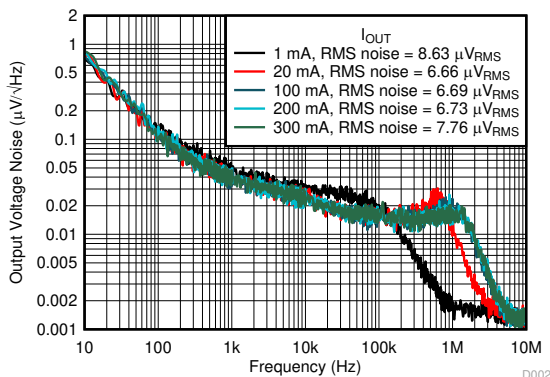

$V_{RMS}\text{ BW} = 10\text{ Hz to }100\text{ kHz}$
Figure 5-65. Noise vs Frequency and I_{OUT}

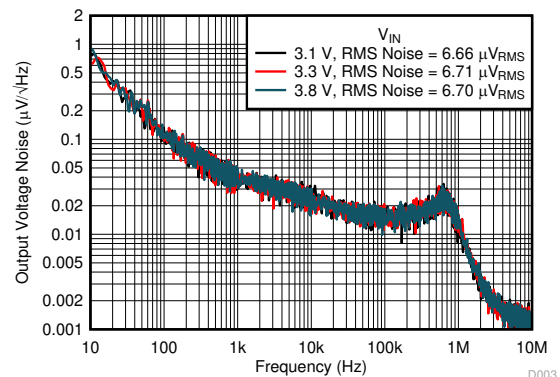

$I_{OUT} = 20\text{ mA}, V_{RMS}\text{ BW} = 10\text{ Hz to }100\text{ kHz}$
Figure 5-66. Noise vs Frequency and V_{IN}

5.7 Typical Characteristics (continued)

$V_{IN} = V_{OUT(NOM)} + 0.3\text{ V}$ or 1.6 V (whichever is greater), $V_{OUT} = 2.8\text{ V}$, $I_{OUT} = 1\text{ mA}$, $C_{IN} = 1\text{ }\mu\text{F}$, $C_{OUT} = 1\text{ }\mu\text{F}$, and $T_A = 25^\circ\text{C}$ (unless otherwise noted)



$I_{OUT} = 300\text{ mA}$, $V_{RMS}\text{ BW} = 10\text{ Hz to }100\text{ kHz}$

Figure 5-67. Noise vs Frequency and V_{IN}



$V_{IN} = 3.8\text{ V}$, $I_{OUT} = 20\text{ mA}$, $V_{RMS}\text{ BW} = 10\text{ Hz to }100\text{ kHz}$

Figure 5-68. Noise vs Frequency and C_{OUT}



$V_{IN} = 3.8\text{ V}$, $I_{OUT} = 300\text{ mA}$, $V_{RMS}\text{ BW} = 10\text{ Hz to }100\text{ kHz}$

Figure 5-69. Noise vs Frequency and C_{OUT}



$V_{OUT} = 0.8\text{ V}$, $V_{RMS}\text{ BW} = 10\text{ Hz to }100\text{ kHz}$

Figure 5-70. Noise vs Frequency and I_{OUT}



$V_{OUT} = 0.8\text{ V}$, $V_{IN} = 1.8\text{ V}$, $V_{RMS}\text{ BW} = 10\text{ Hz to }100\text{ kHz}$

Figure 5-71. Noise vs Frequency and I_{OUT}



$V_{OUT} = 5.5\text{ V}$, $V_{IN} = 6\text{ V}$, $V_{RMS}\text{ BW} = 10\text{ Hz to }100\text{ kHz}$

Figure 5-72. Noise vs Frequency and I_{OUT}

5.7 Typical Characteristics (continued)

$V_{IN} = V_{OUT(NOM)} + 0.3\text{ V}$ or 1.6 V (whichever is greater), $V_{OUT} = 2.8\text{ V}$, $I_{OUT} = 1\text{ mA}$, $C_{IN} = 1\text{ }\mu\text{F}$, $C_{OUT} = 1\text{ }\mu\text{F}$, and $T_A = 25^\circ\text{C}$ (unless otherwise noted)

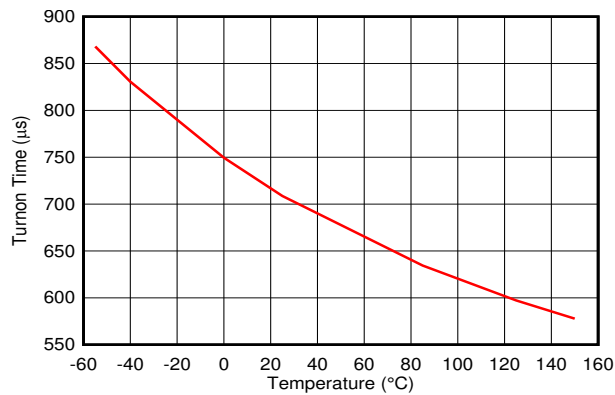

From $V_{EN} = V_{EN(HI)}$ to $V_{OUT} = 95\%$ of $V_{OUT(NOM)}$, $I_{OUT} = 0\text{ mA}$

Figure 5-73. Start-Up Turn-On Time

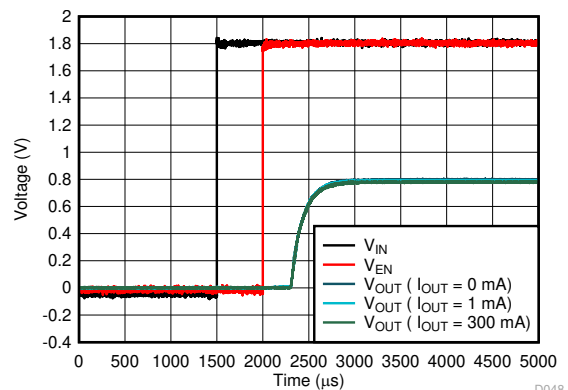

$V_{OUT} = 0.8\text{ V}$, $V_{IN} = 0\text{ V}$ to 1.8 V , $V_{EN} = 0\text{ V}$ to 1.8 V , V_{EN} rises $500\text{ }\mu\text{s}$ behind V_{IN} , V_{IN} and V_{EN} slew rate = $1\text{ V}/\mu\text{s}$

Figure 5-74. Start-Up

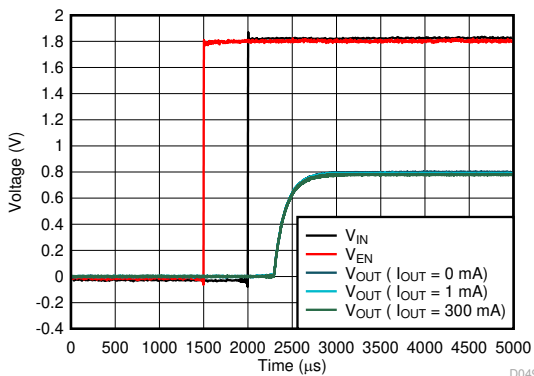

$V_{OUT} = 0.8\text{ V}$, $V_{IN} = 0\text{ V}$ to 1.8 V , $V_{EN} = 0\text{ V}$ to 1.8 V , V_{EN} rises $500\text{ }\mu\text{s}$ ahead of V_{IN} , V_{IN} and V_{EN} slew rate = $1\text{ V}/\mu\text{s}$

Figure 5-75. Start-Up

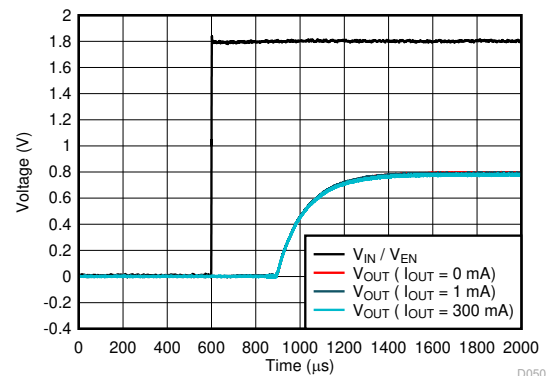

$V_{OUT} = 0.8\text{ V}$, $V_{IN} = 0\text{ V}$ to 1.8 V , $V_{EN} = V_{IN}$, V_{IN} slew rate = $1\text{ V}/\mu\text{s}$

Figure 5-76. Start-Up

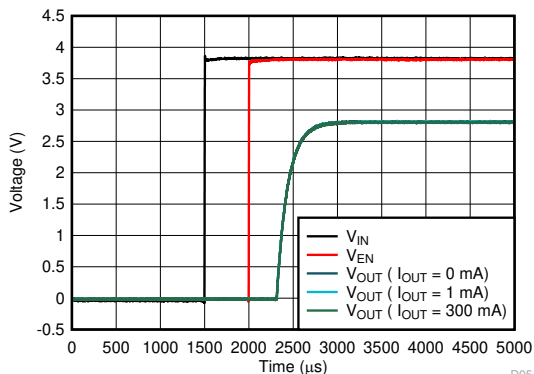

$V_{IN} = 0\text{ V}$ to 3.8 V , $V_{EN} = 0\text{ V}$ to 3.8 V , V_{EN} rises $500\text{ }\mu\text{s}$ behind V_{IN} , V_{IN} and V_{EN} slew rate = $1\text{ V}/\mu\text{s}$

Figure 5-77. Start-Up

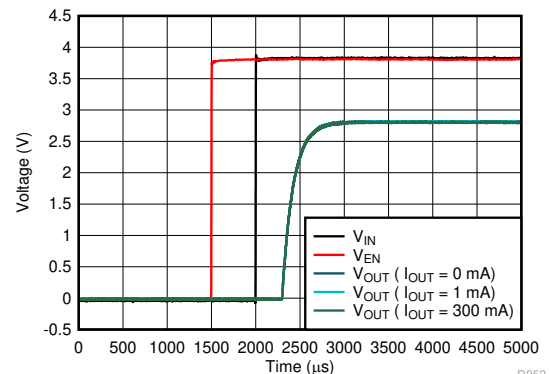

$V_{IN} = 0\text{ V}$ to 3.8 V , $V_{EN} = 0\text{ V}$ to 3.8 V , V_{EN} rises $500\text{ }\mu\text{s}$ ahead of V_{IN} , V_{IN} and V_{EN} slew rate = $1\text{ V}/\mu\text{s}$

Figure 5-78. Start-Up

5.7 Typical Characteristics (continued)

$V_{IN} = V_{OUT(NOM)} + 0.3\text{ V}$ or 1.6 V (whichever is greater), $V_{OUT} = 2.8\text{ V}$, $I_{OUT} = 1\text{ mA}$, $C_{IN} = 1\text{ }\mu\text{F}$, $C_{OUT} = 1\text{ }\mu\text{F}$, and $T_A = 25^\circ\text{C}$ (unless otherwise noted)



$V_{IN} = 0\text{ V}$ to 3.8 V , $V_{EN} = 0\text{ V}$ to 3.8 V , $V_{EN} = V_{IN}$, V_{IN} and slew rate = $1\text{ V}/\mu\text{s}$

Figure 5-79. Start-Up

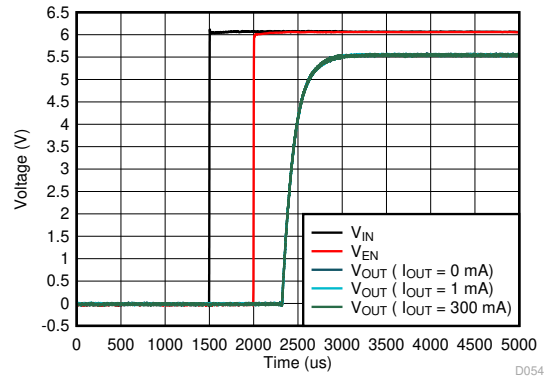

$V_{OUT} = 5.5\text{ V}$, $V_{IN} = 0\text{ V}$ to 6.0 V , $V_{EN} = 0\text{ V}$ to 6.0 V , V_{EN} rises $500\text{ }\mu\text{s}$ behind V_{IN} , V_{IN} and V_{EN} slew rate = $1\text{ V}/\mu\text{s}$

Figure 5-80. Start-Up



$V_{OUT} = 5.5\text{ V}$, $V_{IN} = 0\text{ V}$ to 6.0 V , $V_{EN} = 0\text{ V}$ to 6.0 V , V_{EN} rises $500\text{ }\mu\text{s}$ ahead of V_{IN} , V_{IN} and V_{EN} slew rate = $1\text{ V}/\mu\text{s}$

Figure 5-81. Start-Up

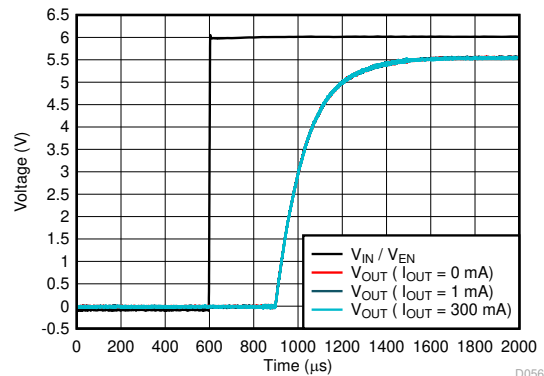

$V_{OUT} = 5.5\text{ V}$, $V_{IN} = 0\text{ V}$ to 6 V , $V_{EN} = V_{IN}$, V_{IN} slew rate = $1\text{ V}/\mu\text{s}$

Figure 5-82. Start-Up

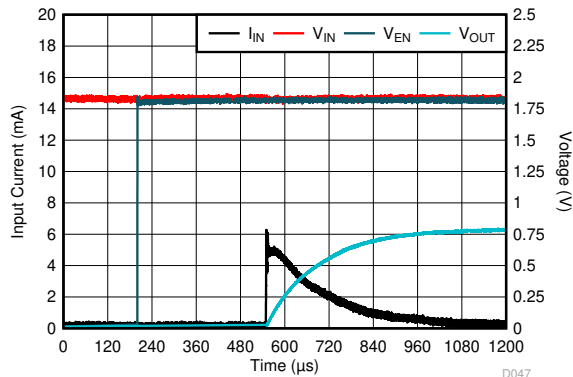

$V_{OUT} = 0.8\text{ V}$, $V_{IN} = 1.8\text{ V}$, $V_{EN} = 0\text{ V}$ to 1.8 V , V_{EN} slew rate = $1\text{ V}/\mu\text{s}$, $C_{OUT} = 10\text{ }\mu\text{F}$

Figure 5-83. Inrush Current



$V_{IN} = 3.8\text{ V}$, $V_{EN} = 0\text{ V}$ to 3.8 V , V_{EN} slew rate = $1\text{ V}/\mu\text{s}$, $C_{OUT} = 10\text{ }\mu\text{F}$

Figure 5-84. Inrush Current

5.7 Typical Characteristics (continued)

$V_{IN} = V_{OUT(NOM)} + 0.3\text{ V}$ or 1.6 V (whichever is greater), $V_{OUT} = 2.8\text{ V}$, $I_{OUT} = 1\text{ mA}$, $C_{IN} = 1\text{ }\mu\text{F}$, $C_{OUT} = 1\text{ }\mu\text{F}$, and $T_A = 25^\circ\text{C}$ (unless otherwise noted)



$V_{OUT} = 5.5\text{ V}$, $V_{IN} = 6.0\text{ V}$, $V_{EN} = 0\text{ V to } 6.0\text{ V}$,
 V_{EN} slew rate = $1\text{ V}/\mu\text{s}$, $C_{OUT} = 10\text{ }\mu\text{F}$

Figure 5-85. Inrush Current

6 Detailed Description

6.1 Overview

Designed to meet the needs of sensitive RF and analog circuits, the TPS7A20 provides low noise, high PSRR, low quiescent current, as well as low line and load transient response figures. Using innovative design techniques, the TPS7A20 offers class-leading noise performance without the need for a separate noise filter capacitor.

The TPS7A20 is designed to operate with a single 1- μF input capacitor and a single 1- μF ceramic output capacitor.

6.2 Functional Block Diagram

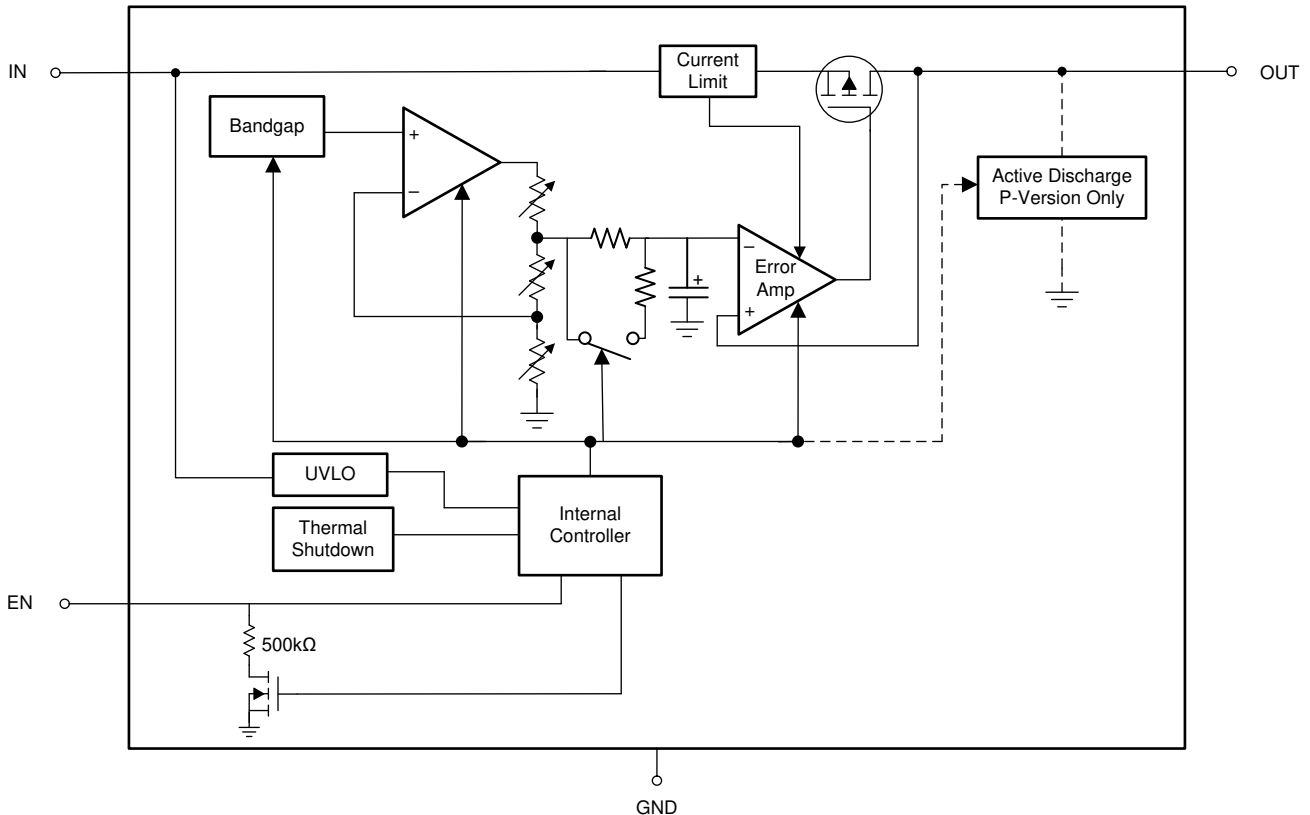

6.3 Feature Description

6.3.1 Low Output Noise

Any internal noise at the TPS7A20 reference voltage is reduced by a first-order, low-pass RC filter before being passed to the output buffer stage. The low-pass RC filter has a -3dB cut-off frequency of approximately 0.1Hz .

During start-up, the filter resistor is bypassed to reduce output rise time; the filter begins normal operation after the output voltage reaches the correct value.

6.3.2 Smart Enable

The enable (EN) input polarity is active high. The output voltage is enabled when the voltage of the enable input is greater than $V_{\text{EN(HI)}}$ and disabled when the enable input voltage is less than $V_{\text{EN(LOW)}}$. If independent control of the output voltage is not needed, connect EN to IN.

This device has a smart enable circuit to reduce quiescent current. When the voltage on the enable pin is driven above $V_{\text{EN(HI)}}$, as listed in the *Electrical Characteristics* table, the device is enabled and the smart enable internal pulldown resistor ($R_{\text{EN(PULLDOWN)}}$) is disconnected. When the enable pin is floating, the $R_{\text{EN(PULLDOWN)}}$ is connected and pulls the enable pin low to disable the device. The $R_{\text{EN(PULLDOWN)}}$ value is listed in the *Electrical Characteristics* table.

6.3.3 Dropout Voltage

Dropout voltage (V_{DO}) is defined as the input voltage minus the output voltage ($V_{\text{IN}} - V_{\text{OUT}}$) at the rated output current (I_{RATED}), where the pass transistor is fully on. I_{RATED} is the maximum I_{OUT} listed in the *Recommended Operating Conditions* table. The pass transistor is in the ohmic or triode region of operation, and acts as a switch. The dropout voltage indirectly specifies a minimum input voltage greater than the nominal programmed output voltage at which the output voltage is expected to stay in regulation. If the input voltage falls to less than the value required to maintain output regulation, then the output voltage falls as well.

For a CMOS regulator, the dropout voltage is determined by the drain-source on-state resistance ($R_{\text{DS(ON)}}$) of the pass transistor. Therefore, if the linear regulator operates at less than the rated current, the dropout voltage for that current scales accordingly. The following equation calculates the $R_{\text{DS(ON)}}$ of the device.

$$R_{\text{DS(ON)}} = \frac{V_{\text{DO}}}{I_{\text{RATED}}} \quad (1)$$

6.3.4 Foldback Current Limit

The device has an internal current limit circuit that protects the regulator during transient high-load current faults or shorting events. The current limit is a hybrid brick-wall-foldback scheme. The current limit transitions from a brick-wall scheme to a foldback scheme at the foldback voltage (V_{FOLDBACK}). In a high-load current fault with the output voltage above V_{FOLDBACK} , the brick-wall scheme limits the output current to the current limit (I_{CL}). When the voltage drops below V_{FOLDBACK} , a foldback current limit activates that scales back the current as the output voltage approaches GND. When the output is shorted, the device supplies a typical current called the short-circuit current limit (I_{SC}). I_{CL} and I_{SC} are listed in the *Electrical Characteristics* table.

The output voltage is not regulated when the device is in current limit. When a current limit event occurs, the device begins to heat up because of the increase in power dissipation. When the device is in brick-wall current limit, the pass transistor dissipates power $[(V_{\text{IN}} - V_{\text{OUT}}) \times I_{\text{CL}}]$. When the device output is shorted and the output is below V_{FOLDBACK} , the pass transistor dissipates power $[(V_{\text{IN}} - V_{\text{OUT}}) \times I_{\text{SC}}]$. If thermal shutdown is triggered, the device turns off. After the device cools down, the internal thermal shutdown circuit turns the device back on. If the output current fault condition continues, the device cycles between current limit and thermal shutdown. For more information on current limits, see the [Know Your Limits application note](#).

Figure 6-1 shows a diagram of the foldback current limit.



Figure 6-1. Foldback Current Limit

6.3.5 Undervoltage Lockout (UVLO)

The device has an independent undervoltage lockout (UVLO) circuit that monitors the input voltage, allowing a controlled and consistent turn on and off of the output voltage. To prevent the device from turning off if the input drops during turn on, the UVLO has hysteresis as specified in the *Electrical Characteristics* table.

6.3.6 Thermal Shutdown

A thermal shutdown protection circuit disables the LDO when the junction temperature (T_J) of the pass transistor rises to $T_{SD(shutdown)}$ (typical). Thermal shutdown hysteresis assures that the device resets (turns on) when the temperature falls to $T_{SD(reset)}$ (typical).

The thermal time-constant of the semiconductor die is fairly short, thus the device may cycle on and off when thermal shutdown is reached until power dissipation is reduced. Power dissipation during startup can be high from large $V_{IN} - V_{OUT}$ voltage drops across the device or from high inrush currents charging large output capacitors. Under some conditions, the thermal shutdown protection disables the device before startup completes.

For reliable operation, limit the junction temperature to the maximum listed in the *Recommended Operating Conditions* table. Operation above this maximum temperature causes the device to exceed its operational specifications. Although the internal protection circuitry of the device is designed to protect against thermal overload conditions, this circuitry is not intended to replace proper heat sinking. Continuously running the device into thermal shutdown or above the maximum recommended junction temperature reduces long-term reliability.

6.3.7 Active Discharge (P Version Only)

An internal pulldown MOSFET connects a resistor from OUT to ground when the device is disabled to actively discharge the output capacitance. The active discharge circuit is activated by driving EN low or by the voltage on IN falling below the undervoltage lockout (UVLO) threshold.

Do not rely on the active discharge circuit for discharging a large amount of output capacitance after the input supply has collapsed because reverse current can possibly flow from the output to the input. This reverse current flow can cause damage to the device. Limit reverse current to no more than 5% of the device rated current for a short period of time.

6.4 Device Functional Modes

6.4.1 Device Functional Mode Comparison

Table 6-1 shows the conditions that lead to the different modes of operation. See the *Electrical Characteristics* table for parameter values.

Table 6-1. Device Functional Mode Comparison

OPERATING MODE	PARAMETER			
	V_{IN}	V_{EN}	I_{OUT}	T_J
Normal operation	$V_{IN} > V_{OUT(nom)} + V_{DO}$ and $V_{IN} > V_{IN(min)}$	$V_{EN} > V_{EN(HI)}$	$I_{OUT} < I_{OUT(max)}$	$T_J < T_{SD(shutdown)}$
Dropout operation	$V_{IN(min)} < V_{IN} < V_{OUT(nom)} + V_{DO}$	$V_{EN} > V_{EN(HI)}$	$I_{OUT} < I_{OUT(max)}$	$T_J < T_{SD(shutdown)}$
Disabled (any true condition disables the device)	$V_{IN} < V_{UVLO}$	$V_{EN} < V_{EN(LOW)}$	Not applicable	$T_J > T_{SD(shutdown)}$

6.4.2 Normal Operation

The device regulates to the nominal output voltage when the following conditions are met:

- The input voltage is greater than the nominal output voltage plus the dropout voltage ($V_{OUT(nom)} + V_{DO}$)
- The output current is less than the current limit ($I_{OUT} < I_{CL}$)
- The device junction temperature is less than the thermal shutdown temperature ($T_J < T_{SD}$)
- The enable voltage has previously exceeded the enable rising threshold voltage and has not yet decreased to less than the enable falling threshold

6.4.3 Dropout Operation

If the input voltage is lower than the nominal output voltage plus the specified dropout voltage, but all other conditions are met for normal operation, the device operates in dropout mode. In this mode, the output voltage tracks the input voltage. During this mode, the transient performance of the device becomes significantly degraded because the pass transistor is in the ohmic or triode region, and acts as a switch. Line or load transients in dropout can result in large output-voltage deviations.

When the device is in a steady dropout state (defined as when the device is in dropout, $V_{IN} < V_{OUT(NOM)} + V_{DO}$, directly after being in a normal regulation state, but *not* during startup), the pass transistor is driven into the ohmic or triode region. When the input voltage returns to a value greater than or equal to the nominal output voltage plus the dropout voltage ($V_{OUT(NOM)} + V_{DO}$), the output voltage can overshoot for a short period of time while the device pulls the pass transistor back into the linear region.

6.4.4 Disabled

The output of the LDO can be shut down by driving EN to less than $V_{EN(LOW)}$ (see the *Electrical Characteristics* table). When disabled, the pass transistor is turned off, internal circuits are shut down, and the output voltage is actively discharged to ground by an internal discharge circuit between OUT and ground.

7 Application and Implementation

Note

Information in the following applications sections is not part of the TI component specification, and TI does not warrant its accuracy or completeness. TI's customers are responsible for determining suitability of components for their purposes, as well as validating and testing their design implementation to confirm system functionality.

7.1 Application Information

7.1.1 Recommended Capacitor Types

The device is designed to be stable using low equivalent series resistance (ESR) ceramic capacitors at the input and output. Multilayer ceramic capacitors have become the industry standard for these types of applications and are recommended, but must be used with good judgment. Ceramic capacitors that employ X7R-, X5R-, and COG-rated dielectric materials provide relatively good capacitive stability across temperature, whereas the use of Y5V-rated capacitors is discouraged because of large variations in capacitance.

Regardless of the ceramic capacitor type selected, the effective capacitance varies with operating voltage and temperature. As a rule of thumb, expect the effective capacitance to decrease by as much as 50%. The input and output capacitors recommended in the *Recommended Operating Conditions* table account for an effective capacitance of approximately 50% of the nominal value.

7.1.2 Input and Output Capacitor Requirements

Although the LDO itself is stable without an input capacitor, good analog design practice is to connect a capacitor from IN to GND, with a value at least equal to the nominal value specified in the *Recommended Operating Conditions* table. The input capacitor counteracts reactive input sources and improves transient response, input ripple, and PSRR, and is recommended if the source impedance is greater than 0.5 Ω . When the source resistance and inductance are sufficiently high, especially in the presence of load transients, the overall system may be susceptible to instability (including ringing and sustained oscillation) and other performance degradation if there is insufficient capacitance between IN and GND. A capacitor with a value greater than the minimum may be necessary if large, fast-rise-time load or line transients are anticipated or if the device is located more than a few centimeters from the input power source.

An output capacitor of an appropriate value helps ensure stability and improve dynamic performance. Use an output capacitor within the range specified in the *Recommended Operating Conditions* table.

7.1.3 Load Transient Response

The load-step transient response is the output voltage response by the LDO to a step in load current, whereby output voltage regulation is maintained. There are two key transitions during a load transient response: the transition from a light to a heavy load and the transition from a heavy to a light load. The regions shown in [Figure 7-1](#) are broken down as follows. Regions A, E, and H are where the output voltage is in steady-state.

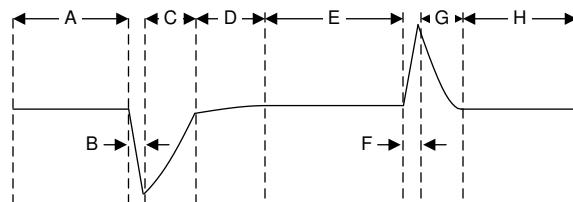

Figure 7-1. Load Transient Waveform

During transitions from a light load to a heavy load, the:

- Initial voltage dip is a result of the depletion of the output capacitor charge and parasitic impedance to the output capacitor (region B)

- Recovery from the dip results from the LDO increasing its sourcing current, and leads to output voltage regulation (region C)

During transitions from a heavy load to a light load, the:

- Initial voltage rise results from the LDO sourcing a large current, and leads to the output capacitor charge to increase (region F)
- Recovery from the rise results from the LDO decreasing its sourcing current in combination with the load discharging the output capacitor (region G)

A larger output capacitance reduces the peaks during a load transient but slows down the response time of the device. A larger DC load also reduces the peaks because the amplitude of the transition is lowered and a higher current discharge path is provided for the output capacitor.

7.1.4 Undervoltage Lockout (UVLO) Operation

The UVLO circuit ensures that the device stays disabled before its input supply reaches the minimum operational voltage range, and ensures that the device shuts down when the input supply collapses. [Figure 7-2](#) shows the UVLO circuit response to various input voltage events. The diagram can be separated into the following parts:

- Region A: The device does not start until the input reaches the UVLO rising threshold.
- Region B: Normal operation, regulating device.
- Region C: Brownout event above the UVLO falling threshold (UVLO rising threshold – UVLO hysteresis). The output may fall out of regulation but the device remains enabled.
- Region D: Normal operation, regulating device.
- Region E: Brownout event below the UVLO falling threshold. The device is disabled in most cases and the output falls because of the load and active discharge circuit. The device is re-enabled when the UVLO rising threshold is reached by the input voltage and a normal start-up follows.
- Region F: Normal operation followed by the input falling to the UVLO falling threshold.
- Region G: The device is disabled when the input voltage falls below the UVLO falling threshold to 0 V. The output falls because of the load and active discharge circuit.

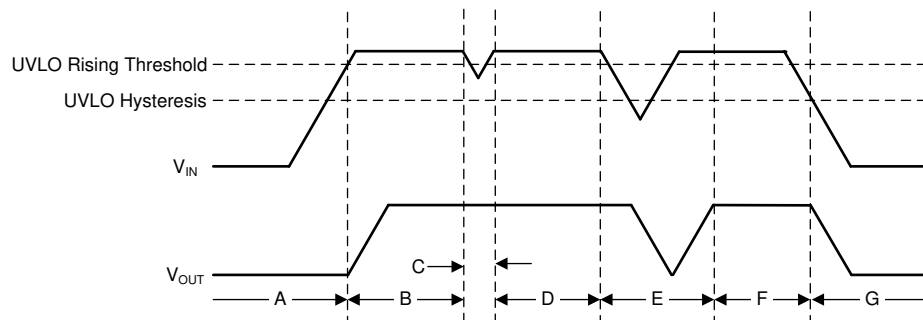

Figure 7-2. Typical UVLO Operation

7.1.5 Power Dissipation (P_D)

Circuit reliability demands that proper consideration be given to device power dissipation, location of the circuit on the printed circuit board (PCB), and correct sizing of the thermal plane. The PCB area around the regulator must be as free as possible of other heat-generating devices that cause added thermal stresses.

As a first-order approximation, power dissipation in the regulator depends on the input-to-output voltage difference and load conditions. Use [Equation 2](#) to approximate P_D :

$$P_D = (V_{IN} - V_{OUT}) \times I_{OUT} \quad (2)$$

Power dissipation can be minimized, and thus greater efficiency achieved, by proper selection of the system voltage rails. Proper selection allows the minimum input-to-output voltage differential to be obtained. The low dropout of the TPS7A20 allows for maximum efficiency across a wide range of output voltages.

The main heat conduction path for the device is through the thermal pad on the package. As such, the thermal pad must be soldered to a copper pad area under the device. This pad area contains an array of plated vias that conduct heat to any inner plane areas or to a bottom-side copper plane.

The maximum power dissipation determines the maximum allowable junction temperature (T_J) for the device. According to [Equation 3](#), power dissipation and junction temperature are most often related by the junction-to-ambient thermal resistance ($R_{\theta JA}$) of the combined PCB and device package and the temperature of the ambient air (T_A). [Equation 4](#) rearranges [Equation 3](#) for output current.

$$T_J = T_A + (R_{\theta JA} \times P_D) \quad (3)$$

$$I_{OUT} = (T_J - T_A) / [R_{\theta JA} \times (V_{IN} - V_{OUT})] \quad (4)$$

Unfortunately, this thermal resistance ($R_{\theta JA}$) is highly dependent on the heat-spreading capability built into the particular PCB design, and therefore varies according to the total copper area, copper weight, and location of the planes. The $R_{\theta JA}$ recorded in the *Thermal Information* table is determined by the JEDEC standard, PCB, and copper-spreading area, and is only used as a relative measure of package thermal performance. For a well-designed thermal layout, $R_{\theta JA}$ is actually the sum of the X2SON package junction-to-case (bottom) thermal resistance ($R_{\theta JC(bot)}$) plus the thermal resistance contribution by the PCB copper.

7.1.5.1 Estimating Junction Temperature

The JEDEC standard now recommends the use of psi (Ψ) thermal metrics to estimate the junction temperatures of the LDO when in-circuit on a typical PCB board application. These metrics are not strictly speaking thermal resistances, but rather offer practical and relative means of estimating junction temperatures. These psi metrics are determined to be significantly independent of the copper-spreading area. The key thermal metrics (Ψ_{JT} and Ψ_{JB}) are used in accordance with [Equation 5](#) and are given in the *Thermal Information* table.

$$\Psi_{JT} : T_J = T_T + \Psi_{JT} \times P_D \text{ and } \Psi_{JB} : T_J = T_B + \Psi_{JB} \times P_D \quad (5)$$

where:

- P_D is the power dissipated as explained in [Equation 2](#)
- T_T is the temperature at the center-top of the device package
- T_B is the PCB surface temperature measured 1 mm from the device package and centered on the package edge

7.1.5.2 Recommended Area for Continuous Operation

The operational area of an LDO is limited by the dropout voltage, output current, junction temperature, and input voltage. The recommended area for continuous operation for a linear regulator is given in [Figure 7-3](#) and can be separated into the following parts:

- Dropout voltage limits the minimum differential voltage between the input and the output ($V_{IN} - V_{OUT}$) at a given output current level. See the [Dropout Operation](#) section for more details.
- The rated output currents limits the maximum recommended output current level. Exceeding this rating causes the device to fall out of specification.
- The rated junction temperature limits the maximum junction temperature of the device. Exceeding this rating causes the device to fall out of specification and reduces long-term reliability.
 - The shape of the slope is given by [Equation 4](#). The slope is nonlinear because the maximum-rated junction temperature of the LDO is controlled by the power dissipation across the LDO; thus when $V_{IN} - V_{OUT}$ increases the output current must decrease.
- The rated input voltage range governs both the minimum and maximum of $V_{IN} - V_{OUT}$.

Figure 7-3 shows the recommended area of operation for this device on a JEDEC-standard high-K board with a $R_{\theta JA}$ as given in the *Thermal Information* table.



Figure 7-3. Region Description of Continuous Operation Regime

7.2 Typical Application

Figure 7-4 shows the typical application circuit for the TPS7A20. Input and output capacitances may need to be increased above the 1 μF minimum for some applications.



SVA-30180501

Figure 7-4. TPS7A20 Typical Application

7.2.1 Design Requirements

Table 7-1 summarizes the design requirements for Figure 7-4.

Table 7-1. Design Parameters

DESIGN PARAMETER	EXAMPLE VALUE
Input voltage range	3.1 V to 3.6 V
Output voltage	2.8 V
Output current	200 mA
Maximum ambient temperature	85°C

7.2.2 Detailed Design Procedure

For this design example, the 2.8V output version (TPS7A2028) is selected. A nominal 3.3V input supply is assumed. A minimum 1.0µF input capacitor is recommended to minimize the effect of resistance and inductance between the 3.3V source and the LDO input. A minimum 1.0µF output capacitor is also recommended for stability and good load transient response. The dropout voltage (V_{DO}) is less than 140mV maximum at a 2.8V output voltage and 300mA output current, so there are no dropout issues with a minimum input voltage of 3.0V and a maximum output current of 200mA.

7.2.3 Application Curves

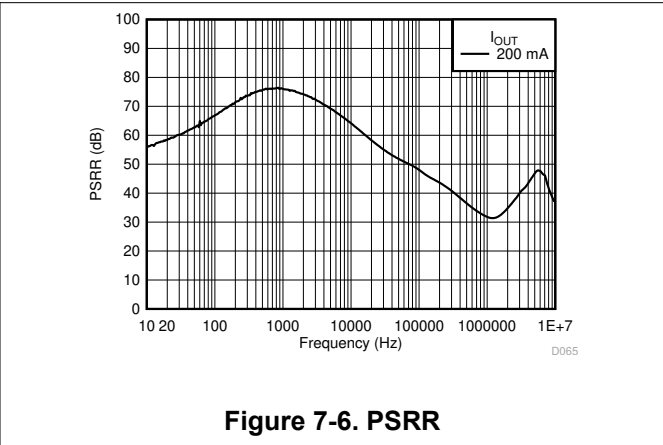
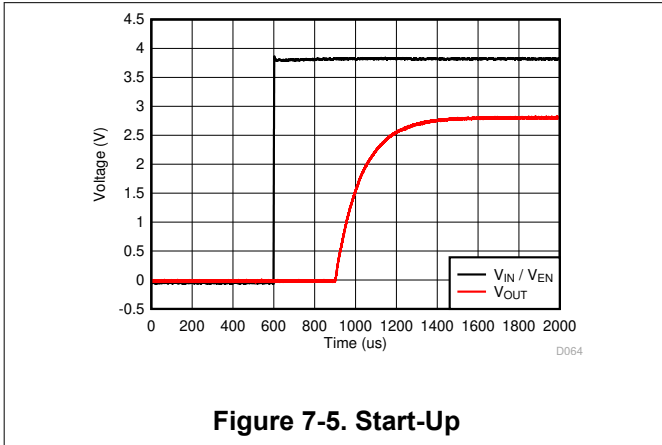

7.3 Power Supply Recommendations

This device is designed to operate from an input supply voltage range of 1.6V to 6.0V. The input supply must be well regulated and free of spurious noise. To ensure that the output voltage is well regulated and dynamic performance is optimum, the input supply must be at least $V_{OUT(nom)} + 0.3V$ or 1.6V, whichever is greater. TI highly recommends using a 1µF or greater input capacitor to reduce the impedance of the input supply, especially during transients.

7.4 Layout

7.4.1 Layout Guidelines

- Place input and output capacitors as close to the device as possible.
- Use copper planes for device connections to optimize thermal performance.
- Place thermal vias around the device to distribute the heat.
- Do not place a thermal via directly beneath the thermal pad of the DQN package. A via can wick solder or solder paste away from the thermal pad joint during the soldering process, leading to a compromised solder joint on the thermal pad.

7.4.2 Layout Examples

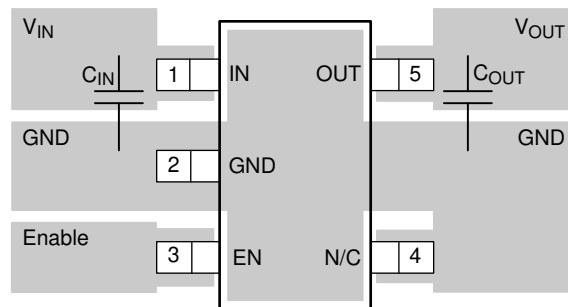

Figure 7-7. DBV Package (SOT-23) Typical Layout



Figure 7-8. DQN Package (X2SON) Typical Layout



Figure 7-9. YCJ and YCK Package (DSBGA) Typical Layout

8 Device and Documentation Support

8.1 Device Support

8.1.1 Device Nomenclature

Table 8-1. Device Nomenclature

PRODUCT ⁽¹⁾ ⁽²⁾	V _{OUT}
TPS7A20xx(x)Pyyyz	<p>xx(x) is the nominal output voltage. For output voltages with a resolution of 100 mV, two digits are used in the ordering number; otherwise, three digits are used (for example, 28 = 2.8V; 125 = 1.25V).</p> <p>P indicates an active output discharge feature.</p> <p>yyy is the package designator.</p> <p>z is the package quantity. R is for reel (3000 pieces for DQN and DBV; 12000 pieces for YCJ and YCK).</p>

- (1) For the most current package and ordering information see the Package Option Addendum at the end of this document, or visit the device product folder on www.ti.com.
- (2) Output voltages from 0.8V to 5.5V in 25mV increments are available. Contact the factory for details and availability.

8.2 Receiving Notification of Documentation Updates

To receive notification of documentation updates, navigate to the device product folder on ti.com. Click on *Notifications* to register and receive a weekly digest of any product information that has changed. For change details, review the revision history included in any revised document.

8.3 Support Resources

[TI E2E™ support forums](#) are an engineer's go-to source for fast, verified answers and design help — straight from the experts. Search existing answers or ask your own question to get the quick design help you need.

Linked content is provided "AS IS" by the respective contributors. They do not constitute TI specifications and do not necessarily reflect TI's views; see TI's [Terms of Use](#).

8.4 Trademarks

TI E2E™ is a trademark of Texas Instruments.
All trademarks are the property of their respective owners.

8.5 Electrostatic Discharge Caution



This integrated circuit can be damaged by ESD. Texas Instruments recommends that all integrated circuits be handled with appropriate precautions. Failure to observe proper handling and installation procedures can cause damage.

ESD damage can range from subtle performance degradation to complete device failure. Precision integrated circuits may be more susceptible to damage because very small parametric changes could cause the device not to meet its published specifications.

8.6 Glossary

[TI Glossary](#) This glossary lists and explains terms, acronyms, and definitions.

9 Revision History

NOTE: Page numbers for previous revisions may differ from page numbers in the current version.

Changes from Revision G (May 2022) to Revision H (July 2024)	Page
• Changed <i>Packages</i> bullet in <i>Features</i> for clarification.....	1
• Changed title of <i>Application Schematic</i> figure.....	1
• Deleted discussion of pulldown resistor from OUT pin description in YCJ and YCK package <i>Pin Functions</i> table.....	3
• Added clarification to <i>Active Discharge (P Version Only)</i> section that this feature only applies to the P device version.....	26
• Changed active output discharge feature discussion in <i>Device Nomenclature</i> table.....	33

Changes from Revision F (April 2022) to Revision G (May 2022)	Page
• Changed UVLO condition from rising to falling for YCJ and YCK packages.....	6

10 Mechanical, Packaging, and Orderable Information

The following pages include mechanical, packaging, and orderable information. This information is the most current data available for the designated devices. This data is subject to change without notice and revision of this document. For browser-based versions of this data sheet, refer to the left-hand navigation.

10.1 Mechanical Data



PACKAGE OUTLINE

YCJ0004-C02

DSBGA - 0.35 mm max height

DIE SIZE BALL GRID ARRAY



NOTES:

1. All linear dimensions are in millimeters. Any dimensions in parenthesis are for reference only. Dimensioning and tolerancing per ASME Y14.5M.
2. This drawing is subject to change without notice.

EXAMPLE BOARD LAYOUT

YCJ0004-C02

DSBGA - 0.35 mm max height

DIE SIZE BALL GRID ARRAY



NOTES: (continued)

- Final dimensions may vary due to manufacturing tolerance considerations and also routing constraints. See Texas Instruments Literature No. SNVA009 (www.ti.com/lit/snva009).

EXAMPLE STENCIL DESIGN

YCJ0004-C02

DSBGA - 0.35 mm max height

DIE SIZE BALL GRID ARRAY

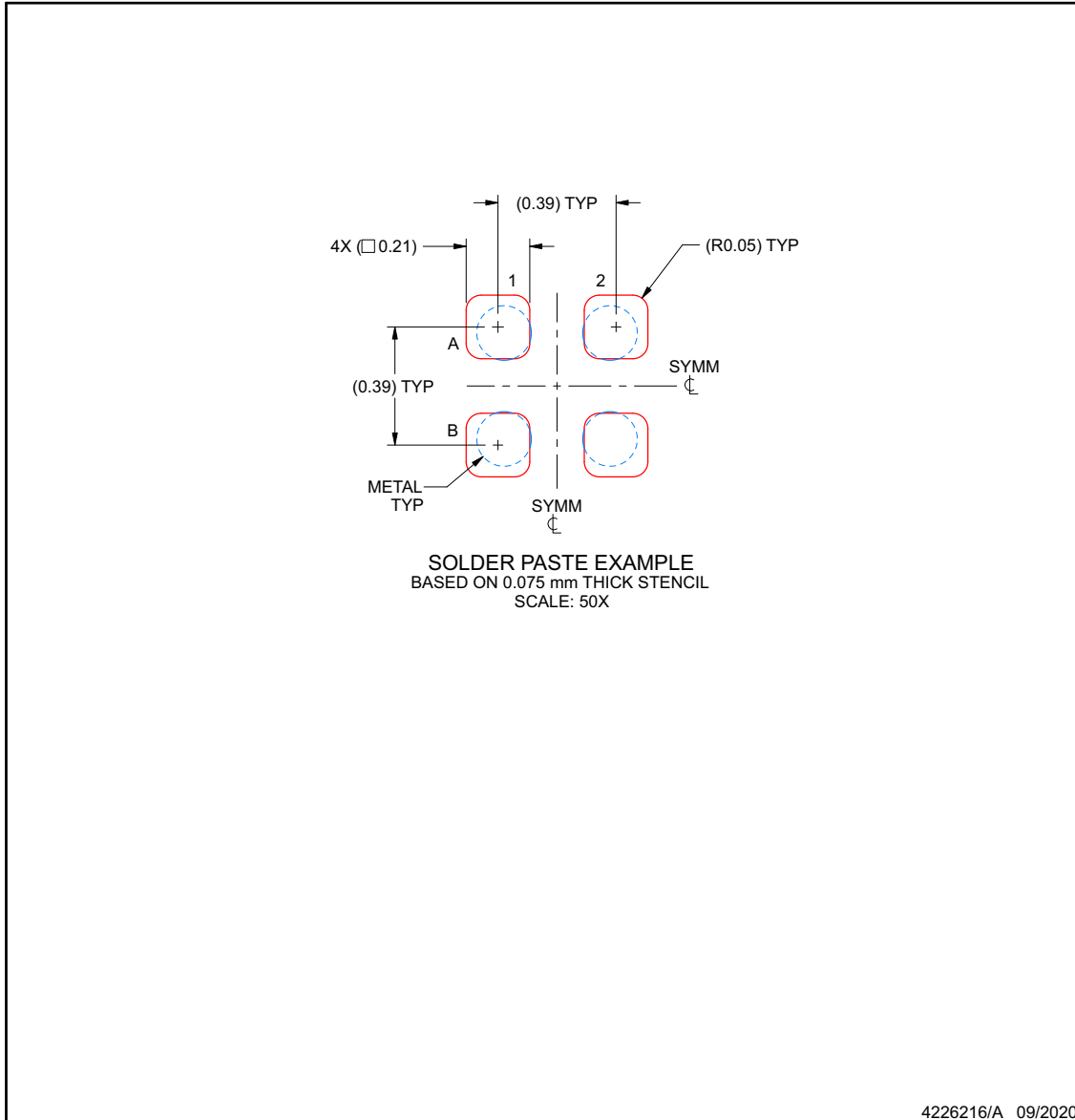

NOTES: (continued)

4. Laser cutting apertures with trapezoidal walls and rounded corners may offer better paste release.



PACKAGE OUTLINE

YCK0004-C01

DSBGA - 0.33mm MAX HEIGHT

DIE SIZE BALL GRID ARRAY



NOTES:

1. All linear dimensions are in millimeters. Dimensions in parenthesis are for reference only. Dimensioning and tolerancing per ASME Y14.5M.
2. This drawing is subject to change without notice.

EXAMPLE BOARD LAYOUT

YCK0004-C01

DSBGA - 0.33mm MAX HEIGHT

DIE SIZE BALL GRID ARRAY



NOTES: (continued)

- Final dimensions may vary due to manufacturing tolerance considerations and also routing constraints. Refer to Texas Instruments Literature No. SNVA009 (www.ti.com/lit/snva009).

EXAMPLE STENCIL DESIGN

YCK0004-C01

DSBGA - 0.33mm MAX HEIGHT

DIE SIZE BALL GRID ARRAY



SOLDERPASTE EXAMPLE
BASED ON 0.075 mm THICK STENCIL
SCALE:80X

4228575/A 03/2022

NOTES: (continued)

- 4. Laser cutting apertures with trapezoidal walls and rounded corners may offer better paste release.

PACKAGING INFORMATION

Orderable part number	Status (1)	Material type (2)	Package Pins	Package qty Carrier	RoHS (3)	Lead finish/ Ball material (4)	MSL rating/ Peak reflow (5)	Op temp (°C)	Part marking (6)
PTPS7A2025PDQNR	Active	Preproduction	X2SON (DQN) 4	3000 LARGE T&R	-	Call TI	Call TI	-40 to 125	
PTPS7A2025PDQNR.A	Active	Preproduction	X2SON (DQN) 4	3000 LARGE T&R	-	Call TI	Call TI	-40 to 125	
PTPS7A2045PDQNR	Active	Preproduction	X2SON (DQN) 4	3000 LARGE T&R	-	Call TI	Call TI	-40 to 125	
PTPS7A2045PDQNR.A	Active	Preproduction	X2SON (DQN) 4	3000 LARGE T&R	-	Call TI	Call TI	-40 to 125	
TPS7A2008DQNR	Active	Production	X2SON (DQN) 4	3000 LARGE T&R	Yes	NIPDAU	Level-1-260C-UNLIM	-40 to 125	QH
TPS7A2008DQNR.A	Active	Production	X2SON (DQN) 4	3000 LARGE T&R	Yes	NIPDAU	Level-1-260C-UNLIM	-40 to 125	QH
TPS7A2009PDBVR	Active	Production	SOT-23 (DBV) 5	3000 LARGE T&R	Yes	NIPDAU SN	Level-1-260C-UNLIM	-40 to 125	2GBF
TPS7A2009PDBVR.A	Active	Production	SOT-23 (DBV) 5	3000 LARGE T&R	Yes	SN	Level-1-260C-UNLIM	-40 to 125	2GBF
TPS7A2009PDQNR	Active	Production	X2SON (DQN) 4	3000 LARGE T&R	Yes	NIPDAU	Level-1-260C-UNLIM	-40 to 125	KT
TPS7A2009PDQNR.A	Active	Production	X2SON (DQN) 4	3000 LARGE T&R	Yes	NIPDAU	Level-1-260C-UNLIM	-40 to 125	KT
TPS7A20105PDQNR	Active	Production	X2SON (DQN) 4	3000 LARGE T&R	Yes	NIPDAU	Level-1-260C-UNLIM	-40 to 125	KS
TPS7A20105PDQNR.A	Active	Production	X2SON (DQN) 4	3000 LARGE T&R	Yes	NIPDAU	Level-1-260C-UNLIM	-40 to 125	KS
TPS7A20115PDQNR	Active	Production	X2SON (DQN) 4	3000 LARGE T&R	Yes	NIPDAU	Level-1-260C-UNLIM	-40 to 125	QE
TPS7A20115PDQNR.A	Active	Production	X2SON (DQN) 4	3000 LARGE T&R	Yes	NIPDAU	Level-1-260C-UNLIM	-40 to 125	QE
TPS7A2011PYCKR	Active	Production	DSBGA (YCK) 4	12000 LARGE T&R	Yes	SNAGCU	Level-1-260C-UNLIM	-40 to 125	Q
TPS7A2011PYCKR.A	Active	Production	DSBGA (YCK) 4	12000 LARGE T&R	Yes	SNAGCU	Level-1-260C-UNLIM	-40 to 125	Q
TPS7A2012DQNR	Active	Production	X2SON (DQN) 4	3000 LARGE T&R	Yes	NIPDAU	Level-1-260C-UNLIM	-40 to 125	QI
TPS7A2012DQNR.A	Active	Production	X2SON (DQN) 4	3000 LARGE T&R	Yes	NIPDAU	Level-1-260C-UNLIM	-40 to 125	QI
TPS7A2012PDBVR	Active	Production	SOT-23 (DBV) 5	3000 LARGE T&R	Yes	NIPDAU SN	Level-1-260C-UNLIM	-40 to 125	2ATF
TPS7A2012PDBVR.A	Active	Production	SOT-23 (DBV) 5	3000 LARGE T&R	Yes	NIPDAU	Level-1-260C-UNLIM	-40 to 125	2ATF
TPS7A2012PDBVRG4	Active	Production	SOT-23 (DBV) 5	3000 LARGE T&R	Yes	NIPDAU	Level-1-260C-UNLIM	-40 to 125	2ATF
TPS7A2012PDBVRG4.A	Active	Production	SOT-23 (DBV) 5	3000 LARGE T&R	Yes	NIPDAU	Level-1-260C-UNLIM	-40 to 125	2ATF
TPS7A2012PDQNR	Active	Production	X2SON (DQN) 4	3000 LARGE T&R	Yes	NIPDAU	Level-1-260C-UNLIM	-40 to 125	JC
TPS7A2012PDQNR.A	Active	Production	X2SON (DQN) 4	3000 LARGE T&R	Yes	NIPDAU	Level-1-260C-UNLIM	-40 to 125	JC
TPS7A2012PYCJR	Active	Production	DSBGA (YCJ) 4	12000 LARGE T&R	Yes	SNAGCU	Level-1-260C-UNLIM	-40 to 125	M
TPS7A2012PYCJR.A	Active	Production	DSBGA (YCJ) 4	12000 LARGE T&R	Yes	SNAGCU	Level-1-260C-UNLIM	-40 to 125	M
TPS7A20135PDQNR	Active	Production	X2SON (DQN) 4	3000 LARGE T&R	Yes	NIPDAU	Level-1-260C-UNLIM	-40 to 125	MM
TPS7A20135PDQNR.A	Active	Production	X2SON (DQN) 4	3000 LARGE T&R	Yes	NIPDAU	Level-1-260C-UNLIM	-40 to 125	MM
TPS7A2013DQNR	Active	Production	X2SON (DQN) 4	3000 LARGE T&R	Yes	NIPDAU	Level-1-260C-UNLIM	-40 to 125	QJ

Orderable part number	Status (1)	Material type (2)	Package Pins	Package qty Carrier	RoHS (3)	Lead finish/ Ball material (4)	MSL rating/ Peak reflow (5)	Op temp (°C)	Part marking (6)
TPS7A2013DQNR.A	Active	Production	X2SON (DQN) 4	3000 LARGE T&R	Yes	NIPDAU	Level-1-260C-UNLIM	-40 to 125	QJ
TPS7A2015PDBVR	Active	Production	SOT-23 (DBV) 5	3000 LARGE T&R	Yes	NIPDAU SN	Level-1-260C-UNLIM	-40 to 125	2DTF
TPS7A2015PDBVR.A	Active	Production	SOT-23 (DBV) 5	3000 LARGE T&R	Yes	NIPDAU	Level-1-260C-UNLIM	-40 to 125	2DTF
TPS7A2015PDQNR	Active	Production	X2SON (DQN) 4	3000 LARGE T&R	Yes	NIPDAU NIPDAUAG	Level-1-260C-UNLIM	-40 to 125	JD
TPS7A2015PDQNR.A	Active	Production	X2SON (DQN) 4	3000 LARGE T&R	Yes	NIPDAU	Level-1-260C-UNLIM	-40 to 125	JD
TPS7A2016YCKR	Active	Production	DSBGA (YCK) 4	12000 LARGE T&R	Yes	SNAGCU	Level-1-260C-UNLIM	-40 to 125	Z
TPS7A2016YCKR.A	Active	Production	DSBGA (YCK) 4	12000 LARGE T&R	Yes	SNAGCU	Level-1-260C-UNLIM	-40 to 125	Z
TPS7A201825PDQNR	Active	Production	X2SON (DQN) 4	3000 LARGE T&R	Yes	NIPDAU NIPDAUAG	Level-1-260C-UNLIM	-40 to 125	IQ
TPS7A201825PDQNR.A	Active	Production	X2SON (DQN) 4	3000 LARGE T&R	Yes	NIPDAU	Level-1-260C-UNLIM	-40 to 125	IQ
TPS7A201825PDQNRM3	Active	Production	X2SON (DQN) 4	3000 LARGE T&R	Yes	NIPDAU	Level-1-260C-UNLIM	-40 to 125	IQ
TPS7A201825PDQNRM3.A	Active	Production	X2SON (DQN) 4	3000 LARGE T&R	Yes	NIPDAU	Level-1-260C-UNLIM	-40 to 125	IQ
TPS7A20185PDBVR	Active	Production	SOT-23 (DBV) 5	3000 LARGE T&R	Yes	NIPDAU SN	Level-1-260C-UNLIM	-40 to 125	2CBF
TPS7A20185PDBVR.A	Active	Production	SOT-23 (DBV) 5	3000 LARGE T&R	Yes	SN	Level-1-260C-UNLIM	-40 to 125	2CBF
TPS7A20185PDBVRG4	Active	Production	SOT-23 (DBV) 5	3000 LARGE T&R	Yes	NIPDAU	Level-1-260C-UNLIM	-40 to 125	2CBF
TPS7A20185PDBVRG4.A	Active	Production	SOT-23 (DBV) 5	3000 LARGE T&R	Yes	NIPDAU	Level-1-260C-UNLIM	-40 to 125	2CBF
TPS7A20185PDQNR	Active	Production	X2SON (DQN) 4	3000 LARGE T&R	Yes	NIPDAU NIPDAUAG	Level-1-260C-UNLIM	-40 to 125	JE
TPS7A20185PDQNR.A	Active	Production	X2SON (DQN) 4	3000 LARGE T&R	Yes	NIPDAU	Level-1-260C-UNLIM	-40 to 125	JE
TPS7A20185PDQNRM3	Active	Production	X2SON (DQN) 4	3000 LARGE T&R	Yes	NIPDAU	Level-1-260C-UNLIM	-40 to 125	JE
TPS7A20185PDQNRM3.A	Active	Production	X2SON (DQN) 4	3000 LARGE T&R	Yes	NIPDAU	Level-1-260C-UNLIM	-40 to 125	JE
TPS7A20185PYCKR	Active	Production	DSBGA (YCK) 4	12000 LARGE T&R	Yes	SNAGCU	Level-1-260C-UNLIM	-40 to 125	T
TPS7A20185PYCKR.A	Active	Production	DSBGA (YCK) 4	12000 LARGE T&R	Yes	SNAGCU	Level-1-260C-UNLIM	-40 to 125	T
TPS7A2018DQNR	Active	Production	X2SON (DQN) 4	3000 LARGE T&R	Yes	NIPDAU	Level-1-260C-UNLIM	-40 to 125	QK
TPS7A2018DQNR.A	Active	Production	X2SON (DQN) 4	3000 LARGE T&R	Yes	NIPDAU	Level-1-260C-UNLIM	-40 to 125	QK
TPS7A2018PDBVR	Active	Production	SOT-23 (DBV) 5	3000 LARGE T&R	Yes	NIPDAU SN	Level-1-260C-UNLIM	-40 to 125	2AUF
TPS7A2018PDBVR.A	Active	Production	SOT-23 (DBV) 5	3000 LARGE T&R	Yes	NIPDAU	Level-1-260C-UNLIM	-40 to 125	2AUF
TPS7A2018PDBVRG4	Active	Production	SOT-23 (DBV) 5	3000 LARGE T&R	Yes	NIPDAU	Level-1-260C-UNLIM	-40 to 125	2AUF
TPS7A2018PDBVRG4.A	Active	Production	SOT-23 (DBV) 5	3000 LARGE T&R	Yes	NIPDAU	Level-1-260C-UNLIM	-40 to 125	2AUF
TPS7A2018PDQNR	Active	Production	X2SON (DQN) 4	3000 LARGE T&R	Yes	NIPDAU NIPDAUAG	Level-1-260C-UNLIM	-40 to 125	JF
TPS7A2018PDQNR.A	Active	Production	X2SON (DQN) 4	3000 LARGE T&R	Yes	NIPDAU	Level-1-260C-UNLIM	-40 to 125	JF
TPS7A2018PDQNRM3	Active	Production	X2SON (DQN) 4	3000 LARGE T&R	Yes	NIPDAU	Level-1-260C-UNLIM	-40 to 125	JF
TPS7A2018PDQNRM3.A	Active	Production	X2SON (DQN) 4	3000 LARGE T&R	Yes	NIPDAU	Level-1-260C-UNLIM	-40 to 125	JF

Orderable part number	Status (1)	Material type (2)	Package Pins	Package qty Carrier	RoHS (3)	Lead finish/ Ball material (4)	MSL rating/ Peak reflow (5)	Op temp (°C)	Part marking (6)
TPS7A2018PYCKR	Active	Production	DSBGA (YCK) 4	12000 LARGE T&R	Yes	SNAGCU	Level-1-260C-UNLIM	-40 to 125	D
TPS7A2018PYCKR.A	Active	Production	DSBGA (YCK) 4	12000 LARGE T&R	Yes	SNAGCU	Level-1-260C-UNLIM	-40 to 125	D
TPS7A2018PYCKRM3	Active	Production	DSBGA (YCK) 4	12000 LARGE T&R	Yes	SNAGCU	Level-1-260C-UNLIM	-40 to 125	D
TPS7A2018YCKR	Active	Production	DSBGA (YCK) 4	12000 LARGE T&R	Yes	SNAGCU	Level-1-260C-UNLIM	-40 to 125	Y
TPS7A2018YCKR.A	Active	Production	DSBGA (YCK) 4	12000 LARGE T&R	Yes	SNAGCU	Level-1-260C-UNLIM	-40 to 125	Y
TPS7A2020PYCKR	Active	Production	DSBGA (YCK) 4	12000 LARGE T&R	Yes	SNAGCU	Level-1-260C-UNLIM	-40 to 125	S
TPS7A2020PYCKR.A	Active	Production	DSBGA (YCK) 4	12000 LARGE T&R	Yes	SNAGCU	Level-1-260C-UNLIM	-40 to 125	S
TPS7A20225PDQNR	Active	Production	X2SON (DQN) 4	3000 LARGE T&R	Yes	NIPDAU	Level-1-260C-UNLIM	-40 to 125	PX
TPS7A20225PDQNR.A	Active	Production	X2SON (DQN) 4	3000 LARGE T&R	Yes	NIPDAU	Level-1-260C-UNLIM	-40 to 125	PX
TPS7A202275PYCKR	Active	Production	DSBGA (YCK) 4	12000 LARGE T&R	Yes	SNAGCU	Level-1-260C-UNLIM	-40 to 125	B
TPS7A202275PYCKR.A	Active	Production	DSBGA (YCK) 4	12000 LARGE T&R	Yes	SNAGCU	Level-1-260C-UNLIM	-40 to 125	B
TPS7A2022PYCKR	Active	Production	DSBGA (YCK) 4	12000 LARGE T&R	Yes	SNAGCU	Level-1-260C-UNLIM	-40 to 125	K
TPS7A2022PYCKR.A	Active	Production	DSBGA (YCK) 4	12000 LARGE T&R	Yes	SNAGCU	Level-1-260C-UNLIM	-40 to 125	K
TPS7A2024PDBVR	Active	Production	SOT-23 (DBV) 5	3000 LARGE T&R	Yes	NIPDAU SN	Level-1-260C-UNLIM	-40 to 125	2CCF
TPS7A2024PDBVR.A	Active	Production	SOT-23 (DBV) 5	3000 LARGE T&R	Yes	SN	Level-1-260C-UNLIM	-40 to 125	2CCF
TPS7A2025DQNR	Active	Production	X2SON (DQN) 4	3000 LARGE T&R	Yes	NIPDAU	Level-1-260C-UNLIM	-40 to 125	QL
TPS7A2025DQNR.A	Active	Production	X2SON (DQN) 4	3000 LARGE T&R	Yes	NIPDAU	Level-1-260C-UNLIM	-40 to 125	QL
TPS7A2025PDBVR	Active	Production	SOT-23 (DBV) 5	3000 LARGE T&R	Yes	NIPDAU SN	Level-1-260C-UNLIM	-40 to 125	2AVF
TPS7A2025PDBVR.A	Active	Production	SOT-23 (DBV) 5	3000 LARGE T&R	Yes	NIPDAU	Level-1-260C-UNLIM	-40 to 125	2AVF
TPS7A2025PDBVRG4	Active	Production	SOT-23 (DBV) 5	3000 LARGE T&R	Yes	NIPDAU	Level-1-260C-UNLIM	-40 to 125	2AVF
TPS7A2025PDBVRG4.A	Active	Production	SOT-23 (DBV) 5	3000 LARGE T&R	Yes	NIPDAU	Level-1-260C-UNLIM	-40 to 125	2AVF
TPS7A2025PDQNR	Active	Production	X2SON (DQN) 4	3000 LARGE T&R	Yes	NIPDAU	Level-1-260C-UNLIM	-40 to 125	JG
TPS7A2025PDQNR.A	Active	Production	X2SON (DQN) 4	3000 LARGE T&R	Yes	NIPDAU	Level-1-260C-UNLIM	-40 to 125	JG
TPS7A2025PYCJR	Active	Production	DSBGA (YCJ) 4	12000 LARGE T&R	Yes	SNAGCU	Level-1-260C-UNLIM	-40 to 125	L
TPS7A2025PYCJR.A	Active	Production	DSBGA (YCJ) 4	12000 LARGE T&R	Yes	SNAGCU	Level-1-260C-UNLIM	-40 to 125	L
TPS7A2027PDQNR	Active	Production	X2SON (DQN) 4	3000 LARGE T&R	Yes	NIPDAU	Level-1-260C-UNLIM	-40 to 125	KO
TPS7A2027PDQNR.A	Active	Production	X2SON (DQN) 4	3000 LARGE T&R	Yes	NIPDAU	Level-1-260C-UNLIM	-40 to 125	KO
TPS7A2027PYCJR	Active	Production	DSBGA (YCJ) 4	12000 LARGE T&R	Yes	SNAGCU	Level-1-260C-UNLIM	-40 to 125	N
TPS7A2027PYCJR.A	Active	Production	DSBGA (YCJ) 4	12000 LARGE T&R	Yes	SNAGCU	Level-1-260C-UNLIM	-40 to 125	N
TPS7A20285PDBVR	Active	Production	SOT-23 (DBV) 5	3000 LARGE T&R	Yes	NIPDAU SN	Level-1-260C-UNLIM	-40 to 125	2GCF
TPS7A20285PDBVR.A	Active	Production	SOT-23 (DBV) 5	3000 LARGE T&R	Yes	NIPDAU	Level-1-260C-UNLIM	-40 to 125	2GCF

Orderable part number	Status (1)	Material type (2)	Package Pins	Package qty Carrier	RoHS (3)	Lead finish/ Ball material (4)	MSL rating/ Peak reflow (5)	Op temp (°C)	Part marking (6)
TPS7A20285PDQNR	Active	Production	X2SON (DQN) 4	3000 LARGE T&R	Yes	NIPDAU	Level-1-260C-UNLIM	-40 to 125	KN
TPS7A20285PDQNR.A	Active	Production	X2SON (DQN) 4	3000 LARGE T&R	Yes	NIPDAU	Level-1-260C-UNLIM	-40 to 125	KN
TPS7A20285PYCKR	Active	Production	DSBGA (YCK) 4	12000 LARGE T&R	Yes	SNAGCU	Level-1-260C-UNLIM	-40 to 125	P
TPS7A20285PYCKR.A	Active	Production	DSBGA (YCK) 4	12000 LARGE T&R	Yes	SNAGCU	Level-1-260C-UNLIM	-40 to 125	P
TPS7A2028DQNR	Active	Production	X2SON (DQN) 4	3000 LARGE T&R	Yes	NIPDAU	Level-1-260C-UNLIM	-40 to 125	QM
TPS7A2028DQNR.A	Active	Production	X2SON (DQN) 4	3000 LARGE T&R	Yes	NIPDAU	Level-1-260C-UNLIM	-40 to 125	QM
TPS7A2028PDBVR	Active	Production	SOT-23 (DBV) 5	3000 LARGE T&R	Yes	NIPDAU SN	Level-1-260C-UNLIM	-40 to 125	2AWF
TPS7A2028PDBVR.A	Active	Production	SOT-23 (DBV) 5	3000 LARGE T&R	Yes	NIPDAU	Level-1-260C-UNLIM	-40 to 125	2AWF
TPS7A2028PDQNR	Active	Production	X2SON (DQN) 4	3000 LARGE T&R	Yes	NIPDAU NIPDAUAG	Level-1-260C-UNLIM	-40 to 125	JH
TPS7A2028PDQNR.A	Active	Production	X2SON (DQN) 4	3000 LARGE T&R	Yes	NIPDAU	Level-1-260C-UNLIM	-40 to 125	JH
TPS7A2028PDQNRM3	Active	Production	X2SON (DQN) 4	3000 LARGE T&R	Yes	NIPDAU	Level-1-260C-UNLIM	-40 to 125	JH
TPS7A2028PDQNRM3.A	Active	Production	X2SON (DQN) 4	3000 LARGE T&R	Yes	NIPDAU	Level-1-260C-UNLIM	-40 to 125	JH
TPS7A2028PYCJR	Active	Production	DSBGA (YCJ) 4	12000 LARGE T&R	Yes	SNAGCU	Level-1-260C-UNLIM	-40 to 125	E
TPS7A2028PYCJR.A	Active	Production	DSBGA (YCJ) 4	12000 LARGE T&R	Yes	SNAGCU	Level-1-260C-UNLIM	-40 to 125	E
TPS7A2028PYCKR	Active	Production	DSBGA (YCK) 4	12000 LARGE T&R	Yes	SNAGCU	Level-1-260C-UNLIM	-40 to 125	E
TPS7A2028PYCKR.A	Active	Production	DSBGA (YCK) 4	12000 LARGE T&R	Yes	SNAGCU	Level-1-260C-UNLIM	-40 to 125	E
TPS7A2029PDQNR	Active	Production	X2SON (DQN) 4	3000 LARGE T&R	Yes	NIPDAU	Level-1-260C-UNLIM	-40 to 125	JI
TPS7A2029PDQNR.A	Active	Production	X2SON (DQN) 4	3000 LARGE T&R	Yes	NIPDAU	Level-1-260C-UNLIM	-40 to 125	JI
TPS7A2030DQNR	Active	Production	X2SON (DQN) 4	3000 LARGE T&R	Yes	NIPDAU	Level-1-260C-UNLIM	-40 to 125	QN
TPS7A2030DQNR.A	Active	Production	X2SON (DQN) 4	3000 LARGE T&R	Yes	NIPDAU	Level-1-260C-UNLIM	-40 to 125	QN
TPS7A2030PDBVR	Active	Production	SOT-23 (DBV) 5	3000 LARGE T&R	Yes	NIPDAU SN	Level-1-260C-UNLIM	-40 to 125	2AXF
TPS7A2030PDBVR.A	Active	Production	SOT-23 (DBV) 5	3000 LARGE T&R	Yes	NIPDAU	Level-1-260C-UNLIM	-40 to 125	2AXF
TPS7A2030PDBVRG4	Active	Production	SOT-23 (DBV) 5	3000 LARGE T&R	Yes	NIPDAU	Level-1-260C-UNLIM	-40 to 125	2AXF
TPS7A2030PDBVRG4.A	Active	Production	SOT-23 (DBV) 5	3000 LARGE T&R	Yes	NIPDAU	Level-1-260C-UNLIM	-40 to 125	2AXF
TPS7A2030PDQNR	Active	Production	X2SON (DQN) 4	3000 LARGE T&R	Yes	NIPDAU	Level-1-260C-UNLIM	-40 to 125	JJ
TPS7A2030PDQNR.A	Active	Production	X2SON (DQN) 4	3000 LARGE T&R	Yes	NIPDAU	Level-1-260C-UNLIM	-40 to 125	JJ
TPS7A2030PDQNRG4	Active	Production	X2SON (DQN) 4	3000 LARGE T&R	Yes	NIPDAU	Level-1-260C-UNLIM	-40 to 125	JJ
TPS7A2030PDQNRG4.A	Active	Production	X2SON (DQN) 4	3000 LARGE T&R	Yes	NIPDAU	Level-1-260C-UNLIM	-40 to 125	JJ
TPS7A2030YCKR	Active	Production	DSBGA (YCK) 4	12000 LARGE T&R	Yes	SNAGCU	Level-1-260C-UNLIM	-40 to 125	X
TPS7A2030YCKR.A	Active	Production	DSBGA (YCK) 4	12000 LARGE T&R	Yes	SNAGCU	Level-1-260C-UNLIM	-40 to 125	X
TPS7A2031PDBVR	Active	Production	SOT-23 (DBV) 5	3000 LARGE T&R	Yes	NIPDAU SN	Level-1-260C-UNLIM	-40 to 125	2GDF

Orderable part number	Status (1)	Material type (2)	Package Pins	Package qty Carrier	RoHS (3)	Lead finish/ Ball material (4)	MSL rating/ Peak reflow (5)	Op temp (°C)	Part marking (6)
TPS7A2031PDBVR.A	Active	Production	SOT-23 (DBV) 5	3000 LARGE T&R	Yes	NIPDAU	Level-1-260C-UNLIM	-40 to 125	2GDF
TPS7A2031PDBVRG4	Active	Production	SOT-23 (DBV) 5	3000 LARGE T&R	Yes	NIPDAU	Level-1-260C-UNLIM	-40 to 125	2GDF
TPS7A2031PDBVRG4.A	Active	Production	SOT-23 (DBV) 5	3000 LARGE T&R	Yes	NIPDAU	Level-1-260C-UNLIM	-40 to 125	2GDF
TPS7A2032PDBVR	Active	Production	SOT-23 (DBV) 5	3000 LARGE T&R	Yes	NIPDAU SN	Level-1-260C-UNLIM	-40 to 125	2GEF
TPS7A2032PDBVR.A	Active	Production	SOT-23 (DBV) 5	3000 LARGE T&R	Yes	NIPDAU	Level-1-260C-UNLIM	-40 to 125	2GEF
TPS7A2033DQNR	Active	Production	X2SON (DQN) 4	3000 LARGE T&R	Yes	NIPDAU	Level-1-260C-UNLIM	-40 to 125	QO
TPS7A2033DQNR.A	Active	Production	X2SON (DQN) 4	3000 LARGE T&R	Yes	NIPDAU	Level-1-260C-UNLIM	-40 to 125	QO
TPS7A2033PDBVR	Active	Production	SOT-23 (DBV) 5	3000 LARGE T&R	Yes	NIPDAU SN	Level-1-260C-UNLIM	-40 to 125	2AZF
TPS7A2033PDBVR.A	Active	Production	SOT-23 (DBV) 5	3000 LARGE T&R	Yes	SN	Level-1-260C-UNLIM	-40 to 125	2AZF
TPS7A2033PDQNR	Active	Production	X2SON (DQN) 4	3000 LARGE T&R	Yes	NIPDAU NIPDAUAG	Level-1-260C-UNLIM	-40 to 125	JA
TPS7A2033PDQNR.A	Active	Production	X2SON (DQN) 4	3000 LARGE T&R	Yes	NIPDAU	Level-1-260C-UNLIM	-40 to 125	JA
TPS7A2033PDQNRM3	Active	Production	X2SON (DQN) 4	3000 LARGE T&R	Yes	NIPDAU	Level-1-260C-UNLIM	-40 to 125	JA
TPS7A2033PDQNRM3.A	Active	Production	X2SON (DQN) 4	3000 LARGE T&R	Yes	NIPDAU	Level-1-260C-UNLIM	-40 to 125	JA
TPS7A2033PYCJR	Active	Production	DSBGA (YCJ) 4	12000 LARGE T&R	Yes	SNAGCU	Level-1-260C-UNLIM	-40 to 125	O
TPS7A2033PYCJR.A	Active	Production	DSBGA (YCJ) 4	12000 LARGE T&R	Yes	SNAGCU	Level-1-260C-UNLIM	-40 to 125	O
TPS7A2033YCKR	Active	Production	DSBGA (YCK) 4	12000 LARGE T&R	Yes	SNAGCU	Level-1-260C-UNLIM	-40 to 125	V
TPS7A2033YCKR.A	Active	Production	DSBGA (YCK) 4	12000 LARGE T&R	Yes	SNAGCU	Level-1-260C-UNLIM	-40 to 125	V
TPS7A2036PDBVR	Active	Production	SOT-23 (DBV) 5	3000 LARGE T&R	Yes	NIPDAU SN	Level-1-260C-UNLIM	-40 to 125	2GIF
TPS7A2036PDBVR.A	Active	Production	SOT-23 (DBV) 5	3000 LARGE T&R	Yes	NIPDAU	Level-1-260C-UNLIM	-40 to 125	2GIF
TPS7A2036PDQNR	Active	Production	X2SON (DQN) 4	3000 LARGE T&R	Yes	NIPDAU	Level-1-260C-UNLIM	-40 to 125	KP
TPS7A2036PDQNR.A	Active	Production	X2SON (DQN) 4	3000 LARGE T&R	Yes	NIPDAU	Level-1-260C-UNLIM	-40 to 125	KP
TPS7A2040PDQNR	Active	Production	X2SON (DQN) 4	3000 LARGE T&R	Yes	NIPDAU	Level-1-260C-UNLIM	-40 to 125	KQ
TPS7A2040PDQNR.A	Active	Production	X2SON (DQN) 4	3000 LARGE T&R	Yes	NIPDAU	Level-1-260C-UNLIM	-40 to 125	KQ
TPS7A2040PDQNRG4	Active	Production	X2SON (DQN) 4	3000 LARGE T&R	Yes	NIPDAU	Level-1-260C-UNLIM	-40 to 125	KQ
TPS7A2040PDQNRG4.A	Active	Production	X2SON (DQN) 4	3000 LARGE T&R	Yes	NIPDAU	Level-1-260C-UNLIM	-40 to 125	KQ
TPS7A2042PDBVR	Active	Production	SOT-23 (DBV) 5	3000 LARGE T&R	Yes	NIPDAU SN	Level-1-260C-UNLIM	-40 to 125	2GFF
TPS7A2042PDBVR.A	Active	Production	SOT-23 (DBV) 5	3000 LARGE T&R	Yes	NIPDAU	Level-1-260C-UNLIM	-40 to 125	2GFF
TPS7A2042PDBVRG4	Active	Production	SOT-23 (DBV) 5	3000 LARGE T&R	Yes	NIPDAU	Level-1-260C-UNLIM	-40 to 125	2GFF
TPS7A2042PDBVRG4.A	Active	Production	SOT-23 (DBV) 5	3000 LARGE T&R	Yes	NIPDAU	Level-1-260C-UNLIM	-40 to 125	2GFF
TPS7A2042PDQNR	Active	Production	X2SON (DQN) 4	3000 LARGE T&R	Yes	NIPDAU	Level-1-260C-UNLIM	-40 to 125	KV
TPS7A2042PDQNR.A	Active	Production	X2SON (DQN) 4	3000 LARGE T&R	Yes	NIPDAU	Level-1-260C-UNLIM	-40 to 125	KV

Orderable part number	Status (1)	Material type (2)	Package Pins	Package qty Carrier	RoHS (3)	Lead finish/ Ball material (4)	MSL rating/ Peak reflow (5)	Op temp (°C)	Part marking (6)
TPS7A2045PDBVR	Active	Production	SOT-23 (DBV) 5	3000 LARGE T&R	Yes	NIPDAU SN	Level-1-260C-UNLIM	-40 to 125	2GGF
TPS7A2045PDBVR.A	Active	Production	SOT-23 (DBV) 5	3000 LARGE T&R	Yes	NIPDAU	Level-1-260C-UNLIM	-40 to 125	2GGF
TPS7A2045PDQNR	Active	Production	X2SON (DQN) 4	3000 LARGE T&R	Yes	NIPDAU	Level-1-260C-UNLIM	-40 to 125	JB
TPS7A2045PDQNR.A	Active	Production	X2SON (DQN) 4	3000 LARGE T&R	Yes	NIPDAU	Level-1-260C-UNLIM	-40 to 125	JB
TPS7A2050PDBVR	Active	Production	SOT-23 (DBV) 5	3000 LARGE T&R	Yes	NIPDAU SN	Level-1-260C-UNLIM	-40 to 125	2B1F
TPS7A2050PDBVR.A	Active	Production	SOT-23 (DBV) 5	3000 LARGE T&R	Yes	SN	Level-1-260C-UNLIM	-40 to 125	2B1F
TPS7A2050PDBVRG4	Active	Production	SOT-23 (DBV) 5	3000 LARGE T&R	Yes	NIPDAU	Level-1-260C-UNLIM	-40 to 125	2B1F
TPS7A2050PDBVRG4.A	Active	Production	SOT-23 (DBV) 5	3000 LARGE T&R	Yes	NIPDAU	Level-1-260C-UNLIM	-40 to 125	2B1F
TPS7A2050PDQNR	Active	Production	X2SON (DQN) 4	3000 LARGE T&R	Yes	NIPDAU	Level-1-260C-UNLIM	-40 to 125	KR
TPS7A2050PDQNR.A	Active	Production	X2SON (DQN) 4	3000 LARGE T&R	Yes	NIPDAU	Level-1-260C-UNLIM	-40 to 125	KR
TPS7A2050PDQNRG4	Active	Production	X2SON (DQN) 4	3000 LARGE T&R	Yes	NIPDAU	Level-1-260C-UNLIM	-40 to 125	KR
TPS7A2050PDQNRG4.A	Active	Production	X2SON (DQN) 4	3000 LARGE T&R	Yes	NIPDAU	Level-1-260C-UNLIM	-40 to 125	KR
TPS7A2050PDQNRM3	Active	Production	X2SON (DQN) 4	3000 LARGE T&R	Yes	NIPDAU	Level-1-260C-UNLIM	-40 to 125	KR
TPS7A2050PDQNRM3.A	Active	Production	X2SON (DQN) 4	3000 LARGE T&R	Yes	NIPDAU	Level-1-260C-UNLIM	-40 to 125	KR
TPS7A2050PYCKR	Active	Production	DSBGA (YCK) 4	12000 LARGE T&R	Yes	SNAGCU	Level-1-260C-UNLIM	-40 to 125	H
TPS7A2050PYCKR.A	Active	Production	DSBGA (YCK) 4	12000 LARGE T&R	Yes	SNAGCU	Level-1-260C-UNLIM	-40 to 125	H
TPS7A2055PDBVR	Active	Production	SOT-23 (DBV) 5	3000 LARGE T&R	Yes	NIPDAU SN	Level-1-260C-UNLIM	-40 to 125	2GHF
TPS7A2055PDBVR.A	Active	Production	SOT-23 (DBV) 5	3000 LARGE T&R	Yes	SN	Level-1-260C-UNLIM	-40 to 125	2GHF
TPS7A2055PDBVRG4	Active	Production	SOT-23 (DBV) 5	3000 LARGE T&R	Yes	NIPDAU	Level-1-260C-UNLIM	-40 to 125	2GHF
TPS7A2055PDBVRG4.A	Active	Production	SOT-23 (DBV) 5	3000 LARGE T&R	Yes	NIPDAU	Level-1-260C-UNLIM	-40 to 125	2GHF

(1) **Status:** For more details on status, see our [product life cycle](#).

(2) **Material type:** When designated, preproduction parts are prototypes/experimental devices, and are not yet approved or released for full production. Testing and final process, including without limitation quality assurance, reliability performance testing, and/or process qualification, may not yet be complete, and this item is subject to further changes or possible discontinuation. If available for ordering, purchases will be subject to an additional waiver at checkout, and are intended for early internal evaluation purposes only. These items are sold without warranties of any kind.

(3) **RoHS values:** Yes, No, RoHS Exempt. See the [TI RoHS Statement](#) for additional information and value definition.

(4) **Lead finish/Ball material:** Parts may have multiple material finish options. Finish options are separated by a vertical ruled line. Lead finish/Ball material values may wrap to two lines if the finish value exceeds the maximum column width.

(5) **MSL rating/Peak reflow:** The moisture sensitivity level ratings and peak solder (reflow) temperatures. In the event that a part has multiple moisture sensitivity ratings, only the lowest level per JEDEC standards is shown. Refer to the shipping label for the actual reflow temperature that will be used to mount the part to the printed circuit board.

(6) **Part marking:** There may be an additional marking, which relates to the logo, the lot trace code information, or the environmental category of the part.

Multiple part markings will be inside parentheses. Only one part marking contained in parentheses and separated by a "~" will appear on a part. If a line is indented then it is a continuation of the previous line and the two combined represent the entire part marking for that device.

Important Information and Disclaimer:The information provided on this page represents TI's knowledge and belief as of the date that it is provided. TI bases its knowledge and belief on information provided by third parties, and makes no representation or warranty as to the accuracy of such information. Efforts are underway to better integrate information from third parties. TI has taken and continues to take reasonable steps to provide representative and accurate information but may not have conducted destructive testing or chemical analysis on incoming materials and chemicals. TI and TI suppliers consider certain information to be proprietary, and thus CAS numbers and other limited information may not be available for release.

In no event shall TI's liability arising out of such information exceed the total purchase price of the TI part(s) at issue in this document sold by TI to Customer on an annual basis.

TAPE AND REEL INFORMATION

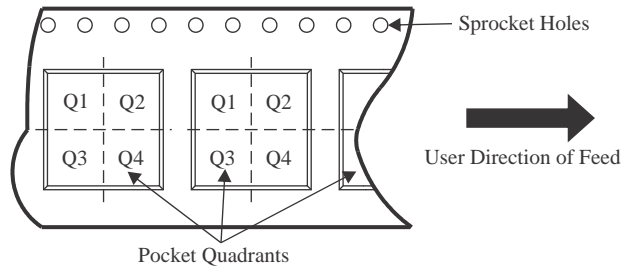
QUADRANT ASSIGNMENTS FOR PIN 1 ORIENTATION IN TAPE

*All dimensions are nominal

Device	Package Type	Package Drawing	Pins	SPQ	Reel Diameter (mm)	Reel Width W1 (mm)	A0 (mm)	B0 (mm)	K0 (mm)	P1 (mm)	W (mm)	Pin1 Quadrant
TPS7A2008DQNR	X2SON	DQN	4	3000	180.0	8.4	1.16	1.16	0.5	4.0	8.0	Q2
TPS7A2009PDBVR	SOT-23	DBV	5	3000	178.0	8.4	3.2	3.2	1.4	4.0	8.0	Q3
TPS7A2009PDQNR	X2SON	DQN	4	3000	180.0	8.4	1.16	1.16	0.5	4.0	8.0	Q2
TPS7A20105PDQNR	X2SON	DQN	4	3000	180.0	8.4	1.16	1.16	0.5	4.0	8.0	Q2
TPS7A20115PDQNR	X2SON	DQN	4	3000	180.0	8.4	1.16	1.16	0.5	4.0	8.0	Q2
TPS7A2011PYCKR	DSBGA	YCK	4	12000	180.0	8.4	0.71	0.71	0.42	2.0	8.0	Q1
TPS7A2011PYCKR	DSBGA	YCK	4	12000	180.0	8.4	0.71	0.71	0.42	2.0	8.0	Q1
TPS7A2012DQNR	X2SON	DQN	4	3000	180.0	8.4	1.16	1.16	0.5	4.0	8.0	Q2
TPS7A2012PDBVR	SOT-23	DBV	5	3000	178.0	8.4	3.2	3.2	1.4	4.0	8.0	Q3
TPS7A2012PDBVRG4	SOT-23	DBV	5	3000	180.0	8.4	3.2	3.2	1.4	4.0	8.0	Q3
TPS7A2012PDBVRG4	SOT-23	DBV	5	3000	180.0	8.4	3.2	3.2	1.4	4.0	8.0	Q3
TPS7A2012PDQNR	X2SON	DQN	4	3000	180.0	8.4	1.16	1.16	0.5	4.0	8.0	Q2
TPS7A2012PYCJR	DSBGA	YCJ	4	12000	180.0	8.4	0.71	0.71	0.42	2.0	8.0	Q1
TPS7A2012PYCJR	DSBGA	YCJ	4	12000	180.0	8.4	0.71	0.71	0.42	2.0	8.0	Q1
TPS7A20135PDQNR	X2SON	DQN	4	3000	180.0	8.4	1.16	1.16	0.5	4.0	8.0	Q2
TPS7A2013DQNR	X2SON	DQN	4	3000	180.0	8.4	1.16	1.16	0.5	4.0	8.0	Q2

Device	Package Type	Package Drawing	Pins	SPQ	Reel Diameter (mm)	Reel Width W1 (mm)	A0 (mm)	B0 (mm)	K0 (mm)	P1 (mm)	W (mm)	Pin1 Quadrant
TPS7A2015PDBVR	SOT-23	DBV	5	3000	178.0	8.4	3.2	3.2	1.4	4.0	8.0	Q3
TPS7A2015PDQNR	X2SON	DQN	4	3000	180.0	8.4	1.16	1.16	0.5	4.0	8.0	Q2
TPS7A2016YCKR	DSBGA	YCK	4	12000	180.0	8.4	0.71	0.71	0.42	2.0	8.0	Q1
TPS7A201825PDQNR	X2SON	DQN	4	3000	178.0	8.4	1.13	1.13	0.53	4.0	8.0	Q2
TPS7A201825PDQNRM3	X2SON	DQN	4	3000	180.0	8.4	1.16	1.16	0.5	4.0	8.0	Q2
TPS7A20185PDBVR	SOT-23	DBV	5	3000	180.0	8.4	3.2	3.2	1.4	4.0	8.0	Q3
TPS7A20185PDBVR	SOT-23	DBV	5	3000	180.0	8.4	3.2	3.2	1.4	4.0	8.0	Q3
TPS7A20185PDBVRG4	SOT-23	DBV	5	3000	180.0	8.4	3.2	3.2	1.4	4.0	8.0	Q3
TPS7A20185PDQNR	X2SON	DQN	4	3000	178.0	8.4	1.13	1.13	0.53	4.0	8.0	Q2
TPS7A20185PDQNRM3	X2SON	DQN	4	3000	180.0	8.4	1.16	1.16	0.5	4.0	8.0	Q2
TPS7A20185PYCKR	DSBGA	YCK	4	12000	180.0	8.4	0.71	0.71	0.42	2.0	8.0	Q1
TPS7A2018DQNR	X2SON	DQN	4	3000	180.0	8.4	1.16	1.16	0.5	4.0	8.0	Q2
TPS7A2018PDBVR	SOT-23	DBV	5	3000	178.0	9.0	3.3	3.2	1.4	4.0	8.0	Q3
TPS7A2018PDBVR	SOT-23	DBV	5	3000	178.0	8.4	3.2	3.2	1.4	4.0	8.0	Q3
TPS7A2018PDBVRG4	SOT-23	DBV	5	3000	180.0	8.4	3.2	3.2	1.4	4.0	8.0	Q3
TPS7A2018PDBVRG4	SOT-23	DBV	5	3000	180.0	8.4	3.2	3.2	1.4	4.0	8.0	Q3
TPS7A2018PDQNR	X2SON	DQN	4	3000	178.0	8.4	1.13	1.13	0.53	4.0	8.0	Q2
TPS7A2018PDQNRM3	X2SON	DQN	4	3000	180.0	8.4	1.16	1.16	0.5	4.0	8.0	Q2
TPS7A2018PYCKR	DSBGA	YCK	4	12000	180.0	8.4	0.71	0.71	0.42	2.0	8.0	Q1
TPS7A2018PYCKR	DSBGA	YCK	4	12000	180.0	8.4	0.71	0.71	0.42	2.0	8.0	Q1
TPS7A2018PYCKRM3	DSBGA	YCK	4	12000	180.0	8.4	0.71	0.71	0.42	2.0	8.0	Q1
TPS7A2018PYCKRM3	DSBGA	YCK	4	12000	180.0	8.4	0.71	0.71	0.42	2.0	8.0	Q1
TPS7A2018YCKR	DSBGA	YCK	4	12000	180.0	8.4	0.71	0.71	0.42	2.0	8.0	Q1
TPS7A2020PYCKR	DSBGA	YCK	4	12000	180.0	8.4	0.71	0.71	0.42	2.0	8.0	Q1
TPS7A2020PYCKR	DSBGA	YCK	4	12000	180.0	8.4	0.71	0.71	0.42	2.0	8.0	Q1
TPS7A20225PDQNR	X2SON	DQN	4	3000	180.0	8.4	1.16	1.16	0.5	4.0	8.0	Q2
TPS7A202275PYCKR	DSBGA	YCK	4	12000	180.0	8.4	0.71	0.71	0.42	2.0	8.0	Q1
TPS7A202275PYCKR	DSBGA	YCK	4	12000	180.0	8.4	0.71	0.71	0.42	2.0	8.0	Q1
TPS7A2022PYCKR	DSBGA	YCK	4	12000	180.0	8.4	0.71	0.71	0.42	2.0	8.0	Q1
TPS7A2022PYCKR	DSBGA	YCK	4	12000	180.0	8.4	0.71	0.71	0.42	2.0	8.0	Q1
TPS7A2024PDBVR	SOT-23	DBV	5	3000	180.0	8.4	3.2	3.2	1.4	4.0	8.0	Q3
TPS7A2024PDBVR	SOT-23	DBV	5	3000	180.0	8.4	3.2	3.2	1.4	4.0	8.0	Q3
TPS7A2024PDBVR	SOT-23	DBV	5	3000	180.0	8.4	3.2	3.2	1.4	4.0	8.0	Q3
TPS7A2025DQNR	X2SON	DQN	4	3000	180.0	8.4	1.16	1.16	0.5	4.0	8.0	Q2
TPS7A2025PDBVR	SOT-23	DBV	5	3000	180.0	8.4	3.2	3.2	1.4	4.0	8.0	Q3
TPS7A2025PDBVR	SOT-23	DBV	5	3000	180.0	8.4	3.2	3.2	1.4	4.0	8.0	Q3
TPS7A2025PDBVRG4	SOT-23	DBV	5	3000	180.0	8.4	3.2	3.2	1.4	4.0	8.0	Q3
TPS7A2025PDBVRG4	SOT-23	DBV	5	3000	180.0	8.4	3.2	3.2	1.4	4.0	8.0	Q3
TPS7A2025PDQNR	X2SON	DQN	4	3000	180.0	8.4	1.16	1.16	0.5	4.0	8.0	Q2
TPS7A2025PYCJR	DSBGA	YCJ	4	12000	180.0	8.4	0.71	0.71	0.42	2.0	8.0	Q1
TPS7A2025PYCJR	DSBGA	YCJ	4	12000	180.0	8.4	0.71	0.71	0.42	2.0	8.0	Q1

Device	Package Type	Package Drawing	Pins	SPQ	Reel Diameter (mm)	Reel Width W1 (mm)	A0 (mm)	B0 (mm)	K0 (mm)	P1 (mm)	W (mm)	Pin1 Quadrant
TPS7A2027PDQNR	X2SON	DQN	4	3000	180.0	8.4	1.16	1.16	0.5	4.0	8.0	Q2
TPS7A2027PYCJR	DSBGA	YCJ	4	12000	180.0	8.4	0.71	0.71	0.42	2.0	8.0	Q1
TPS7A2027PYCJR	DSBGA	YCJ	4	12000	180.0	8.4	0.71	0.71	0.42	2.0	8.0	Q1
TPS7A20285PDBVR	SOT-23	DBV	5	3000	178.0	8.4	3.2	3.2	1.4	4.0	8.0	Q3
TPS7A20285PDQNR	X2SON	DQN	4	3000	180.0	8.4	1.16	1.16	0.5	4.0	8.0	Q2
TPS7A20285PYCKR	DSBGA	YCK	4	12000	180.0	8.4	0.71	0.71	0.42	2.0	8.0	Q1
TPS7A2028DQNR	X2SON	DQN	4	3000	180.0	8.4	1.16	1.16	0.5	4.0	8.0	Q2
TPS7A2028PDBVR	SOT-23	DBV	5	3000	178.0	9.0	3.3	3.2	1.4	4.0	8.0	Q3
TPS7A2028PDBVR	SOT-23	DBV	5	3000	180.0	8.4	3.2	3.2	1.4	4.0	8.0	Q3
TPS7A2028PDBVR	SOT-23	DBV	5	3000	180.0	8.4	3.2	3.2	1.4	4.0	8.0	Q3
TPS7A2028PDQNR	X2SON	DQN	4	3000	180.0	8.4	1.16	1.16	0.5	4.0	8.0	Q2
TPS7A2028PDQNRM3	X2SON	DQN	4	3000	180.0	8.4	1.16	1.16	0.5	4.0	8.0	Q2
TPS7A2028PYCJR	DSBGA	YCJ	4	12000	180.0	8.4	0.71	0.71	0.42	2.0	8.0	Q1
TPS7A2028PYCJR	DSBGA	YCJ	4	12000	180.0	8.4	0.71	0.71	0.42	2.0	8.0	Q1
TPS7A2028PYCKR	DSBGA	YCK	4	12000	180.0	8.4	0.71	0.71	0.42	2.0	8.0	Q1
TPS7A2028PYCKR	DSBGA	YCK	4	12000	180.0	8.4	0.71	0.71	0.42	2.0	8.0	Q1
TPS7A2029PDQNR	X2SON	DQN	4	3000	180.0	8.4	1.16	1.16	0.5	4.0	8.0	Q2
TPS7A2030DQNR	X2SON	DQN	4	3000	180.0	8.4	1.16	1.16	0.5	4.0	8.0	Q2
TPS7A2030PDBVR	SOT-23	DBV	5	3000	178.0	8.4	3.2	3.2	1.4	4.0	8.0	Q3
TPS7A2030PDBVRG4	SOT-23	DBV	5	3000	180.0	8.4	3.2	3.2	1.4	4.0	8.0	Q3
TPS7A2030PDBVRG4	SOT-23	DBV	5	3000	180.0	8.4	3.2	3.2	1.4	4.0	8.0	Q3
TPS7A2030PDQNR	X2SON	DQN	4	3000	180.0	8.4	1.16	1.16	0.5	4.0	8.0	Q2
TPS7A2030PDQNRG4	X2SON	DQN	4	3000	180.0	8.4	1.16	1.16	0.5	4.0	8.0	Q2
TPS7A2030YCKR	DSBGA	YCK	4	12000	180.0	8.4	0.71	0.71	0.42	2.0	8.0	Q1
TPS7A2031PDBVR	SOT-23	DBV	5	3000	180.0	8.4	3.2	3.2	1.4	4.0	8.0	Q3
TPS7A2031PDBVRG4	SOT-23	DBV	5	3000	180.0	8.4	3.2	3.2	1.4	4.0	8.0	Q3
TPS7A2032PDBVR	SOT-23	DBV	5	3000	180.0	8.4	3.2	3.2	1.4	4.0	8.0	Q3
TPS7A2033DQNR	X2SON	DQN	4	3000	180.0	8.4	1.16	1.16	0.5	4.0	8.0	Q2
TPS7A2033PDBVR	SOT-23	DBV	5	3000	178.0	8.4	3.2	3.2	1.4	4.0	8.0	Q3
TPS7A2033PDQNR	X2SON	DQN	4	3000	178.0	8.4	1.13	1.13	0.53	4.0	8.0	Q2
TPS7A2033PDQNRM3	X2SON	DQN	4	3000	180.0	8.4	1.16	1.16	0.5	4.0	8.0	Q2
TPS7A2033PYCJR	DSBGA	YCJ	4	12000	180.0	8.4	0.71	0.71	0.42	2.0	8.0	Q1
TPS7A2033PYCJR	DSBGA	YCJ	4	12000	180.0	8.4	0.71	0.71	0.42	2.0	8.0	Q1
TPS7A2033YCKR	DSBGA	YCK	4	12000	180.0	8.4	0.71	0.71	0.42	2.0	8.0	Q1
TPS7A2036PDBVR	SOT-23	DBV	5	3000	178.0	8.4	3.2	3.2	1.4	4.0	8.0	Q3
TPS7A2036PDQNR	X2SON	DQN	4	3000	180.0	8.4	1.16	1.16	0.5	4.0	8.0	Q2
TPS7A2040PDQNR	X2SON	DQN	4	3000	180.0	9.5	1.16	1.16	0.5	4.0	8.0	Q2
TPS7A2040PDQNRG4	X2SON	DQN	4	3000	180.0	9.5	1.16	1.16	0.5	4.0	8.0	Q2
TPS7A2042PDBVR	SOT-23	DBV	5	3000	180.0	8.4	3.2	3.2	1.4	4.0	8.0	Q3
TPS7A2042PDBVR	SOT-23	DBV	5	3000	178.0	9.0	3.3	3.2	1.4	4.0	8.0	Q3
TPS7A2042PDBVRG4	SOT-23	DBV	5	3000	180.0	8.4	3.2	3.2	1.4	4.0	8.0	Q3

Device	Package Type	Package Drawing	Pins	SPQ	Reel Diameter (mm)	Reel Width W1 (mm)	A0 (mm)	B0 (mm)	K0 (mm)	P1 (mm)	W (mm)	Pin1 Quadrant
TPS7A2042PDQNR	X2SON	DQN	4	3000	180.0	8.4	1.16	1.16	0.5	4.0	8.0	Q2
TPS7A2045PDBVR	SOT-23	DBV	5	3000	180.0	8.4	3.2	3.2	1.4	4.0	8.0	Q3
TPS7A2045PDBVR	SOT-23	DBV	5	3000	178.0	9.0	3.3	3.2	1.4	4.0	8.0	Q3
TPS7A2045PDBVR	SOT-23	DBV	5	3000	180.0	8.4	3.2	3.2	1.4	4.0	8.0	Q3
TPS7A2045PDQNR	X2SON	DQN	4	3000	180.0	8.4	1.16	1.16	0.5	4.0	8.0	Q2
TPS7A2050PDBVR	SOT-23	DBV	5	3000	178.0	8.4	3.2	3.2	1.4	4.0	8.0	Q3
TPS7A2050PDBVRG4	SOT-23	DBV	5	3000	180.0	8.4	3.2	3.2	1.4	4.0	8.0	Q3
TPS7A2050PDQNR	X2SON	DQN	4	3000	180.0	8.4	1.16	1.16	0.5	4.0	8.0	Q2
TPS7A2050PDQNRG4	X2SON	DQN	4	3000	180.0	8.4	1.16	1.16	0.5	4.0	8.0	Q2
TPS7A2050PDQNRM3	X2SON	DQN	4	3000	180.0	8.4	1.16	1.16	0.5	4.0	8.0	Q2
TPS7A2050PYCKR	DSBGA	YCK	4	12000	180.0	8.4	0.71	0.71	0.42	2.0	8.0	Q1
TPS7A2050PYCKR	DSBGA	YCK	4	12000	180.0	8.4	0.71	0.71	0.42	2.0	8.0	Q1
TPS7A2055PDBVR	SOT-23	DBV	5	3000	178.0	9.0	3.3	3.2	1.4	4.0	8.0	Q3
TPS7A2055PDBVR	SOT-23	DBV	5	3000	180.0	8.4	3.2	3.2	1.4	4.0	8.0	Q3
TPS7A2055PDBVRG4	SOT-23	DBV	5	3000	180.0	8.4	3.2	3.2	1.4	4.0	8.0	Q3

TAPE AND REEL BOX DIMENSIONS

*All dimensions are nominal

Device	Package Type	Package Drawing	Pins	SPQ	Length (mm)	Width (mm)	Height (mm)
TPS7A2008DQNR	X2SON	DQN	4	3000	210.0	185.0	35.0
TPS7A2009PDBVR	SOT-23	DBV	5	3000	208.0	191.0	35.0
TPS7A2009PDQNR	X2SON	DQN	4	3000	210.0	185.0	35.0
TPS7A20105PDQNR	X2SON	DQN	4	3000	210.0	185.0	35.0
TPS7A20115PDQNR	X2SON	DQN	4	3000	210.0	185.0	35.0
TPS7A2011PYCKR	DSBGA	YCK	4	12000	182.0	182.0	20.0
TPS7A2011PYCKR	DSBGA	YCK	4	12000	182.0	182.0	20.0
TPS7A2012DQNR	X2SON	DQN	4	3000	210.0	185.0	35.0
TPS7A2012PDBVR	SOT-23	DBV	5	3000	208.0	191.0	35.0
TPS7A2012PDBVRG4	SOT-23	DBV	5	3000	210.0	185.0	35.0
TPS7A2012PDBVRG4	SOT-23	DBV	5	3000	210.0	185.0	35.0
TPS7A2012PDQNR	X2SON	DQN	4	3000	210.0	185.0	35.0
TPS7A2012PYCJR	DSBGA	YCJ	4	12000	182.0	182.0	20.0
TPS7A2012PYCJR	DSBGA	YCJ	4	12000	210.0	185.0	35.0
TPS7A20135PDQNR	X2SON	DQN	4	3000	210.0	185.0	35.0
TPS7A2013DQNR	X2SON	DQN	4	3000	210.0	185.0	35.0
TPS7A2015PDBVR	SOT-23	DBV	5	3000	208.0	191.0	35.0
TPS7A2015PDQNR	X2SON	DQN	4	3000	210.0	185.0	35.0

Device	Package Type	Package Drawing	Pins	SPQ	Length (mm)	Width (mm)	Height (mm)
TPS7A2016YCKR	DSBGA	YCK	4	12000	182.0	182.0	20.0
TPS7A201825PDQNR	X2SON	DQN	4	3000	205.0	200.0	33.0
TPS7A201825PDQNRM3	X2SON	DQN	4	3000	210.0	185.0	35.0
TPS7A20185PDBVR	SOT-23	DBV	5	3000	210.0	185.0	35.0
TPS7A20185PDBVR	SOT-23	DBV	5	3000	210.0	185.0	35.0
TPS7A20185PDBVRG4	SOT-23	DBV	5	3000	210.0	185.0	35.0
TPS7A20185PDQNR	X2SON	DQN	4	3000	205.0	200.0	33.0
TPS7A20185PDQNRM3	X2SON	DQN	4	3000	210.0	185.0	35.0
TPS7A20185PYCKR	DSBGA	YCK	4	12000	182.0	182.0	20.0
TPS7A2018DQNR	X2SON	DQN	4	3000	210.0	185.0	35.0
TPS7A2018PDBVR	SOT-23	DBV	5	3000	180.0	180.0	18.0
TPS7A2018PDBVR	SOT-23	DBV	5	3000	208.0	191.0	35.0
TPS7A2018PDBVRG4	SOT-23	DBV	5	3000	210.0	185.0	35.0
TPS7A2018PDBVRG4	SOT-23	DBV	5	3000	210.0	185.0	35.0
TPS7A2018PDQNR	X2SON	DQN	4	3000	205.0	200.0	33.0
TPS7A2018PDQNRM3	X2SON	DQN	4	3000	210.0	185.0	35.0
TPS7A2018PYCKR	DSBGA	YCK	4	12000	182.0	182.0	20.0
TPS7A2018PYCKR	DSBGA	YCK	4	12000	182.0	182.0	20.0
TPS7A2018PYCKRM3	DSBGA	YCK	4	12000	182.0	182.0	20.0
TPS7A2018PYCKRM3	DSBGA	YCK	4	12000	182.0	182.0	20.0
TPS7A2018YCKR	DSBGA	YCK	4	12000	182.0	182.0	20.0
TPS7A2020PYCKR	DSBGA	YCK	4	12000	182.0	182.0	20.0
TPS7A2020PYCKR	DSBGA	YCK	4	12000	182.0	182.0	20.0
TPS7A20225PDQNR	X2SON	DQN	4	3000	210.0	185.0	35.0
TPS7A202275PYCKR	DSBGA	YCK	4	12000	182.0	182.0	20.0
TPS7A202275PYCKR	DSBGA	YCK	4	12000	182.0	182.0	20.0
TPS7A2022PYCKR	DSBGA	YCK	4	12000	182.0	182.0	20.0
TPS7A2022PYCKR	DSBGA	YCK	4	12000	182.0	182.0	20.0
TPS7A2024PDBVR	SOT-23	DBV	5	3000	210.0	185.0	35.0
TPS7A2024PDBVR	SOT-23	DBV	5	3000	210.0	185.0	35.0
TPS7A2024PDBVR	SOT-23	DBV	5	3000	210.0	185.0	35.0
TPS7A2025DQNR	X2SON	DQN	4	3000	210.0	185.0	35.0
TPS7A2025PDBVR	SOT-23	DBV	5	3000	210.0	185.0	35.0
TPS7A2025PDBVR	SOT-23	DBV	5	3000	210.0	185.0	35.0
TPS7A2025PDBVRG4	SOT-23	DBV	5	3000	210.0	185.0	35.0
TPS7A2025PDBVRG4	SOT-23	DBV	5	3000	210.0	185.0	35.0
TPS7A2025PDQNR	X2SON	DQN	4	3000	210.0	185.0	35.0
TPS7A2025PYCJR	DSBGA	YCJ	4	12000	210.0	185.0	35.0
TPS7A2025PYCJR	DSBGA	YCJ	4	12000	182.0	182.0	20.0
TPS7A2027PDQNR	X2SON	DQN	4	3000	210.0	185.0	35.0
TPS7A2027PYCJR	DSBGA	YCJ	4	12000	182.0	182.0	20.0
TPS7A2027PYCJR	DSBGA	YCJ	4	12000	182.0	182.0	20.0
TPS7A20285PDBVR	SOT-23	DBV	5	3000	208.0	191.0	35.0

Device	Package Type	Package Drawing	Pins	SPQ	Length (mm)	Width (mm)	Height (mm)
TPS7A20285PDQNR	X2SON	DQN	4	3000	210.0	185.0	35.0
TPS7A20285PYCKR	DSBGA	YCK	4	12000	182.0	182.0	20.0
TPS7A2028DQNR	X2SON	DQN	4	3000	210.0	185.0	35.0
TPS7A2028PDBVR	SOT-23	DBV	5	3000	180.0	180.0	18.0
TPS7A2028PDBVR	SOT-23	DBV	5	3000	210.0	185.0	35.0
TPS7A2028PDBVR	SOT-23	DBV	5	3000	210.0	185.0	35.0
TPS7A2028PDQNR	X2SON	DQN	4	3000	210.0	185.0	35.0
TPS7A2028PDQNRM3	X2SON	DQN	4	3000	210.0	185.0	35.0
TPS7A2028PYCJR	DSBGA	YCJ	4	12000	182.0	182.0	20.0
TPS7A2028PYCJR	DSBGA	YCJ	4	12000	182.0	182.0	20.0
TPS7A2028PYCKR	DSBGA	YCK	4	12000	182.0	182.0	20.0
TPS7A2028PYCKR	DSBGA	YCK	4	12000	182.0	182.0	20.0
TPS7A2029PDQNR	X2SON	DQN	4	3000	210.0	185.0	35.0
TPS7A2030DQNR	X2SON	DQN	4	3000	210.0	185.0	35.0
TPS7A2030PDBVR	SOT-23	DBV	5	3000	208.0	191.0	35.0
TPS7A2030PDBVRG4	SOT-23	DBV	5	3000	210.0	185.0	35.0
TPS7A2030PDBVRG4	SOT-23	DBV	5	3000	210.0	185.0	35.0
TPS7A2030PDQNR	X2SON	DQN	4	3000	210.0	185.0	35.0
TPS7A2030PDQNRG4	X2SON	DQN	4	3000	210.0	185.0	35.0
TPS7A2030YCKR	DSBGA	YCK	4	12000	182.0	182.0	20.0
TPS7A2031PDBVR	SOT-23	DBV	5	3000	210.0	185.0	35.0
TPS7A2031PDBVRG4	SOT-23	DBV	5	3000	210.0	185.0	35.0
TPS7A2032PDBVR	SOT-23	DBV	5	3000	210.0	185.0	35.0
TPS7A2033DQNR	X2SON	DQN	4	3000	210.0	185.0	35.0
TPS7A2033PDBVR	SOT-23	DBV	5	3000	208.0	191.0	35.0
TPS7A2033PDQNR	X2SON	DQN	4	3000	205.0	200.0	33.0
TPS7A2033PDQNRM3	X2SON	DQN	4	3000	210.0	185.0	35.0
TPS7A2033PYCJR	DSBGA	YCJ	4	12000	182.0	182.0	20.0
TPS7A2033PYCJR	DSBGA	YCJ	4	12000	182.0	182.0	20.0
TPS7A2033YCKR	DSBGA	YCK	4	12000	182.0	182.0	20.0
TPS7A2036PDBVR	SOT-23	DBV	5	3000	208.0	191.0	35.0
TPS7A2036PDQNR	X2SON	DQN	4	3000	210.0	185.0	35.0
TPS7A2040PDQNR	X2SON	DQN	4	3000	184.0	184.0	19.0
TPS7A2040PDQNRG4	X2SON	DQN	4	3000	184.0	184.0	19.0
TPS7A2042PDBVR	SOT-23	DBV	5	3000	210.0	185.0	35.0
TPS7A2042PDBVR	SOT-23	DBV	5	3000	180.0	180.0	18.0
TPS7A2042PDBVRG4	SOT-23	DBV	5	3000	210.0	185.0	35.0
TPS7A2042PDQNR	X2SON	DQN	4	3000	210.0	185.0	35.0
TPS7A2045PDBVR	SOT-23	DBV	5	3000	210.0	185.0	35.0
TPS7A2045PDBVR	SOT-23	DBV	5	3000	180.0	180.0	18.0
TPS7A2045PDBVR	SOT-23	DBV	5	3000	210.0	185.0	35.0
TPS7A2045PDQNR	X2SON	DQN	4	3000	210.0	185.0	35.0
TPS7A2050PDBVR	SOT-23	DBV	5	3000	208.0	191.0	35.0

Device	Package Type	Package Drawing	Pins	SPQ	Length (mm)	Width (mm)	Height (mm)
TPS7A2050PDBVRG4	SOT-23	DBV	5	3000	210.0	185.0	35.0
TPS7A2050PDQNR	X2SON	DQN	4	3000	210.0	185.0	35.0
TPS7A2050PDQNRG4	X2SON	DQN	4	3000	210.0	185.0	35.0
TPS7A2050PDQNRM3	X2SON	DQN	4	3000	210.0	185.0	35.0
TPS7A2050PYCKR	DSBGA	YCK	4	12000	182.0	182.0	20.0
TPS7A2050PYCKR	DSBGA	YCK	4	12000	182.0	182.0	20.0
TPS7A2055PDBVR	SOT-23	DBV	5	3000	180.0	180.0	18.0
TPS7A2055PDBVR	SOT-23	DBV	5	3000	210.0	185.0	35.0
TPS7A2055PDBVRG4	SOT-23	DBV	5	3000	210.0	185.0	35.0

GENERIC PACKAGE VIEW

DQN 4

X2SON - 0.4 mm max height

PLASTIC SMALL OUTLINE - NO LEAD



Images above are just a representation of the package family, actual package may vary.
Refer to the product data sheet for package details.

4210367/F

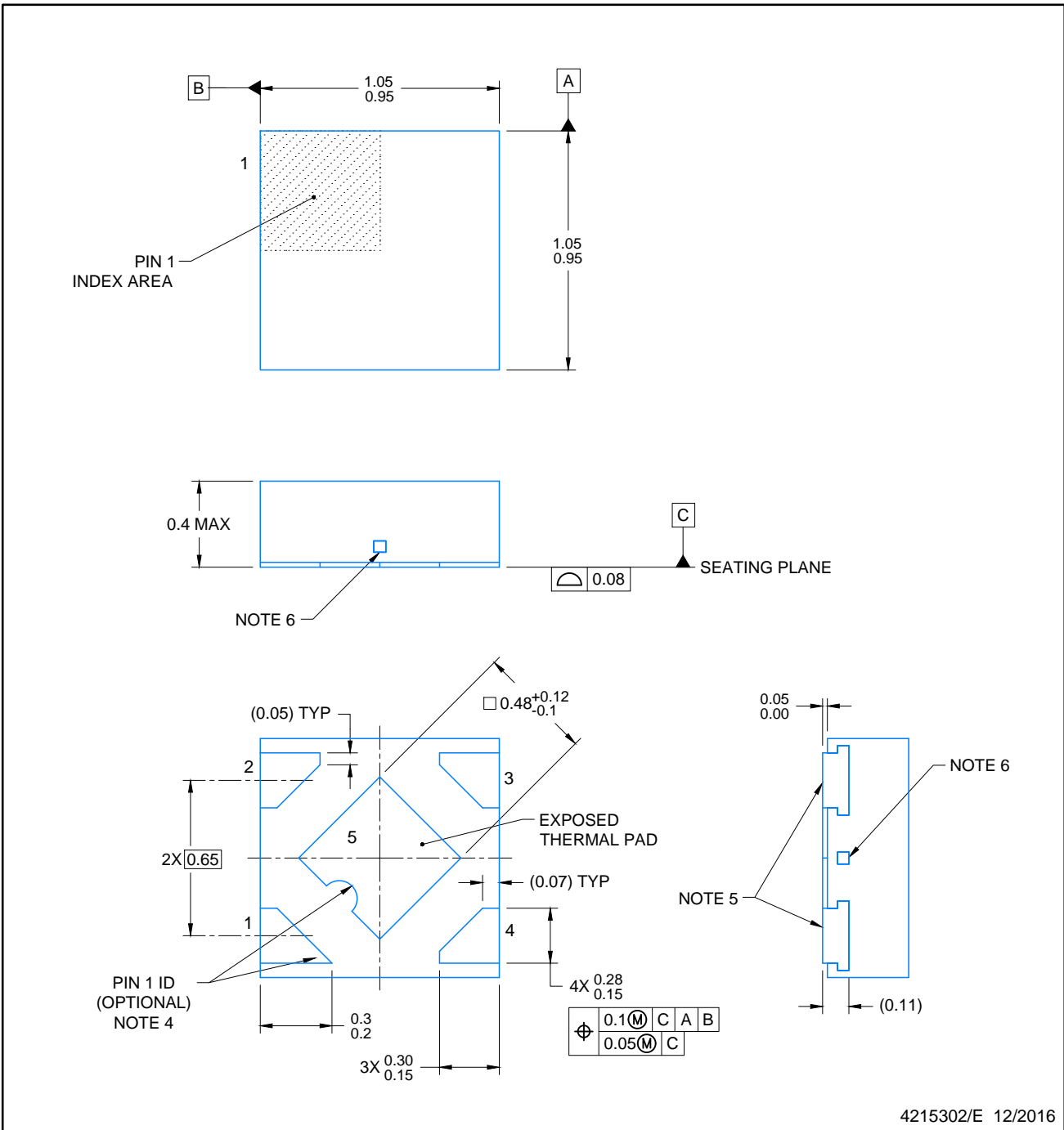

4215302/E 12/2016

NOTES:

1. All linear dimensions are in millimeters. Any dimensions in parenthesis are for reference only. Dimensioning and tolerancing per ASME Y14.5M.
2. This drawing is subject to change without notice.
3. The package thermal pad must be soldered to the printed circuit board for optimal thermal and mechanical performance.
4. Features may not exist. Recommend use of pin 1 marking on top of package for orientation purposes.
5. Shape of exposed side leads may differ.
6. Number and location of exposed tie bars may vary.

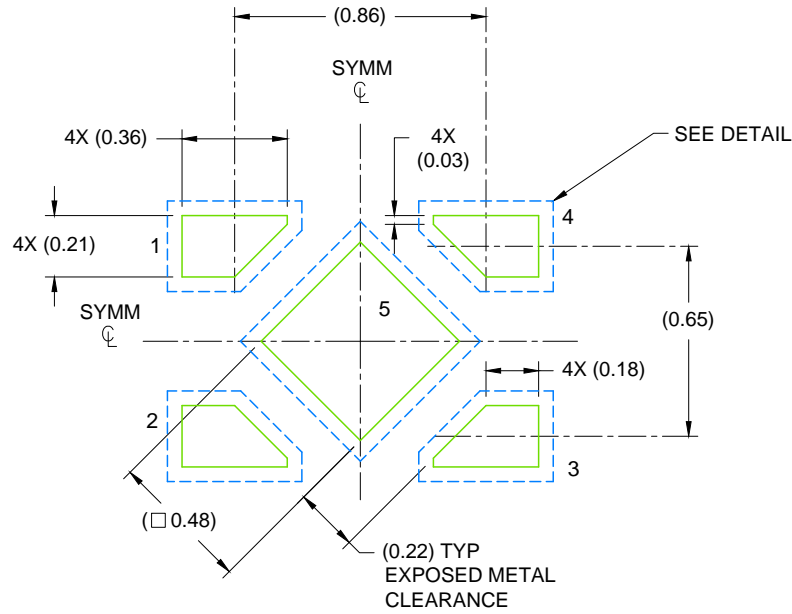

LAND PATTERN EXAMPLE
SCALE: 40X

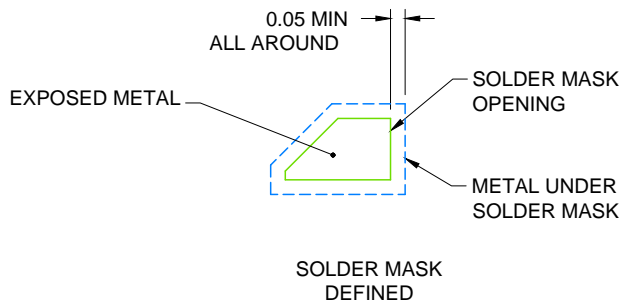

SOLDER MASK DETAIL

4215302/E 12/2016

NOTES: (continued)

7. This package is designed to be soldered to a thermal pad on the board. For more information, see Texas Instruments literature number SLUA271 (www.ti.com/lit/sluea271).
8. If any vias are implemented, it is recommended that vias under paste be filled, plugged or tented.

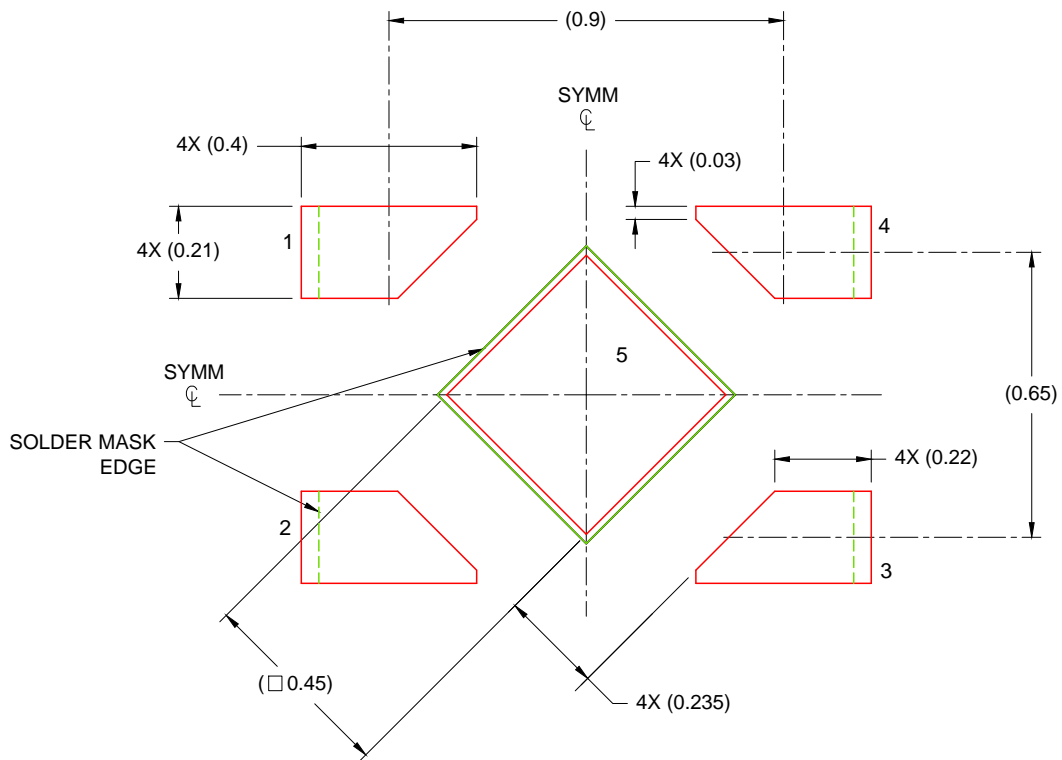

SOLDER PASTE EXAMPLE
 BASED ON 0.075 - 0.1mm THICK STENCIL
 EXPOSED PAD
 88% PRINTED SOLDER COVERAGE BY AREA
 SCALE: 60X

4215302/E 12/2016

NOTES: (continued)

- 9. Laser cutting apertures with trapezoidal walls and rounded corners may offer better paste release. IPC-7525 may have alternate design recommendations.

EXAMPLE BOARD LAYOUT

DBV0005A

SOT-23 - 1.45 mm max height

SMALL OUTLINE TRANSISTOR



LAND PATTERN EXAMPLE
EXPOSED METAL SHOWN
SCALE:15X



SOLDER MASK DETAILS

4214839/K 08/2024

NOTES: (continued)

- 6. Publication IPC-7351 may have alternate designs.
- 7. Solder mask tolerances between and around signal pads can vary based on board fabrication site.

EXAMPLE STENCIL DESIGN

DBV0005A

SOT-23 - 1.45 mm max height

SMALL OUTLINE TRANSISTOR



SOLDER PASTE EXAMPLE
BASED ON 0.125 mm THICK STENCIL
SCALE:15X

4214839/K 08/2024

NOTES: (continued)

8. Laser cutting apertures with trapezoidal walls and rounded corners may offer better paste release. IPC-7525 may have alternate design recommendations.
9. Board assembly site may have different recommendations for stencil design.

IMPORTANT NOTICE AND DISCLAIMER

TI PROVIDES TECHNICAL AND RELIABILITY DATA (INCLUDING DATASHEETS), DESIGN RESOURCES (INCLUDING REFERENCE DESIGNS), APPLICATION OR OTHER DESIGN ADVICE, WEB TOOLS, SAFETY INFORMATION, AND OTHER RESOURCES "AS IS" AND WITH ALL FAULTS, AND DISCLAIMS ALL WARRANTIES, EXPRESS AND IMPLIED, INCLUDING WITHOUT LIMITATION ANY IMPLIED WARRANTIES OF MERCHANTABILITY, FITNESS FOR A PARTICULAR PURPOSE OR NON-INFRINGEMENT OF THIRD PARTY INTELLECTUAL PROPERTY RIGHTS.

These resources are intended for skilled developers designing with TI products. You are solely responsible for (1) selecting the appropriate TI products for your application, (2) designing, validating and testing your application, and (3) ensuring your application meets applicable standards, and any other safety, security, regulatory or other requirements.

These resources are subject to change without notice. TI grants you permission to use these resources only for development of an application that uses the TI products described in the resource. Other reproduction and display of these resources is prohibited. No license is granted to any other TI intellectual property right or to any third party intellectual property right. TI disclaims responsibility for, and you fully indemnify TI and its representatives against any claims, damages, costs, losses, and liabilities arising out of your use of these resources.

TI's products are provided subject to [TI's Terms of Sale](#), [TI's General Quality Guidelines](#), or other applicable terms available either on [ti.com](#) or provided in conjunction with such TI products. TI's provision of these resources does not expand or otherwise alter TI's applicable warranties or warranty disclaimers for TI products. Unless TI explicitly designates a product as custom or customer-specified, TI products are standard, catalog, general purpose devices.

TI objects to and rejects any additional or different terms you may propose.

Copyright © 2026, Texas Instruments Incorporated

Last updated 10/2025