

# TLV704 24-V, 150-mA, 3.2- $\mu$ A Quiescent Current, Low-Dropout Linear Regulator

## 1 Features

- Input voltage range:
  - 2.5 V to 24 V (30 V max for new chip only)
- Available output voltage options:
  - Fixed: 1.8 V to 5 V
- Output current: Up to 150 mA
- Very low  $I_Q$ : 3.4  $\mu$ A at 100-mA load current
- Stable with output capacitor  $\geq 0.47 \mu$ F
- Overcurrent protection
- Package: 5-pin SOT-23 (DBV)
- Operating junction temperature:  $-40^\circ\text{C}$  to  $+125^\circ\text{C}$

## 2 Applications

- [Home and building automation](#)
- [Retail automation and payment](#)
- [Grid infrastructure](#)
- [Medical applications](#)
- [Lighting applications](#)

## 3 Description

The TLV704 low-dropout (LDO) linear voltage regulator is a low quiescent current device that offers the benefits of a wide input voltage range and low-power operation in miniaturized packaging. Thus, the TLV704 is designed for battery-powered applications and as a power-management attachment to low-power microcontrollers.

The TLV704 LDO supports a low dropout of typically 850 mV at 100 mA of load current. The low quiescent current (3.4  $\mu$ A typically) is stable over the entire range of output load current (0 mA to 150 mA). The TLV704 also features an internal soft-start to lower the inrush current. The built-in overcurrent limit protection helps protect the regulator in the event of a load short or fault.

The TLV704 is available in a 2.90-mm  $\times$  1.60-mm SOT23-5 package, which is useful for cost-effective board manufacturing.

### Package Information

PART NUMBER	PACKAGE <sup>(1)</sup>	BODY SIZE (nom)
TLV704	DBV (SOT-23, 5)	2.90 mm $\times$ 1.60 mm

(1) For all available packages, see the orderable addendum at the end of the data sheet.

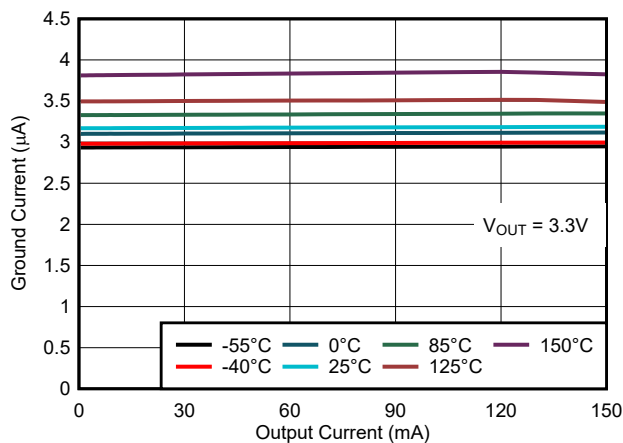

**Figure 3-1. Quiescent Current vs Load Current for TLV704xx (New Chip Only)**

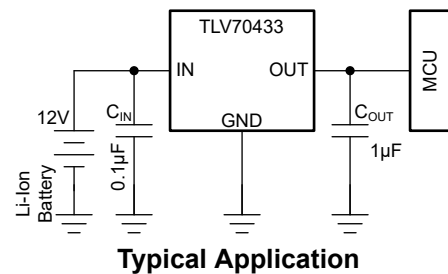

**Typical Application**



## Table of Contents

<b>1 Features</b> .....	1	<b>8 Application and Implementation</b> .....	15
<b>2 Applications</b> .....	1	8.1 Application Information.....	15
<b>3 Description</b> .....	1	8.2 Typical Application.....	15
<b>4 Revision History</b> .....	2	8.3 Best Design Practices.....	19
<b>5 Pin Configuration and Functions</b> .....	3	8.4 Power Supply Recommendations.....	20
<b>6 Specifications</b> .....	4	8.5 Layout.....	20
6.1 Absolute Maximum Ratings.....	4	<b>9 Device and Documentation Support</b> .....	21
6.2 ESD Ratings.....	4	9.1 Device Support.....	21
6.3 Recommended Operating Conditions.....	5	9.2 Documentation Support.....	21
Thermal Information.....	5	9.3 Receiving Notification of Documentation Updates.....	21
6.4 Electrical Characteristics.....	6	9.4 Support Resources.....	21
6.5 Typical Characteristics.....	7	9.5 Trademarks.....	21
<b>7 Detailed Description</b> .....	12	9.6 Electrostatic Discharge Caution.....	21
7.1 Overview.....	12	9.7 Glossary.....	21
7.2 Functional Block Diagram.....	12	<b>10 Mechanical, Packaging, and Orderable Information</b> .....	22
7.3 Feature Description.....	12		
7.4 Device Functional Modes.....	14		

## 4 Revision History

NOTE: Page numbers for previous revisions may differ from page numbers in the current version.

<b>Changes from Revision E (December 2022) to Revision F (March 2023)</b>	<b>Page</b>
• Changed fixed output options to show the range of options instead of each individually in <i>Features</i> section...	1
• Corrected the abs max rating of $V_{OUT}$ pin for legacy chip .....	4
• Corrected the operating max range of $V_{OUT}$ pin.....	5
• Corrected the supported output current range from 50 mA to 150 mA.....	5
• Changed <i>Application Curves</i> section.....	18

<b>Changes from Revision D (January 2015) to Revision E (December 2022)</b>	<b>Page</b>
• Changed document title, <i>Features</i> , <i>Applications</i> , and <i>Description</i> sections and added M3 device information to document.....	1
• Changed <i>Pin Configuration and Functions</i> section.....	3
• Added new chip specific curves to <i>Typical Characteristics</i> section.....	7
• Changed <i>Overview</i> section.....	12
• Changed <i>Functional Block Diagram</i> image.....	12
• Changed <i>Feature Description</i> section.....	12
• Deleted thermal shutdown discussion from <i>Current Limit</i> section.....	13
• Changed <i>Normal Operation</i> section.....	14
• Changed <i>Dropout Operation</i> section.....	14
• Changed <i>Application Information</i> section.....	15
• Added <i>External Capacitor Requirements</i> , <i>Reverse Current</i> , and <i>Power Dissipation</i> sub-sections to <i>Detailed Design Procedure</i> section.....	15
• Changed <i>Input and Output Capacitor Requirements</i> section.....	15
• Added <i>Reverse Current</i> section.....	16
• Changed <i>Estimating Junction Temperature</i> section.....	17
• Added <i>Best Design Practices</i> section.....	19
• Changed <i>Power Supply Recommendations</i> section.....	20
• Changed <i>Layout Guidelines</i> section.....	20
• Changed <i>Power Dissipation</i> section: changed title and deleted last sentence from section.....	20
• Added M3 row to <i>Available Options</i> table.....	21

## 5 Pin Configuration and Functions

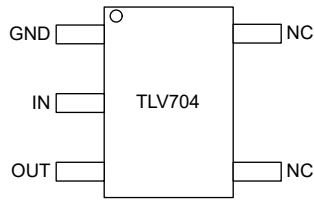

**Figure 5-1. DBV Package, 5-Pin SOT-23 (Top View)**

**Table 5-1. Pin Functions**

PIN		TYPE	DESCRIPTION
NAME	DBV		
GND	1	—	Ground pin.
IN	2	I	Input supply pin. A capacitor with a value of 0.1 $\mu\text{F}$ or larger is recommended from this pin to ground. See the <a href="#">Input and Output Capacitor Requirements</a> section for more information.
OUT	3	O	Output of the regulator. A capacitor with a value of 1 $\mu\text{F}$ or larger is required from this pin to ground. <sup>(1)</sup> See the <a href="#">Input and Output Capacitor Requirements</a> section for more information.
NC	4, 5	—	Not internally connected. This pin can be left open or tied to ground for improved thermal performance.

- (1) The nominal output capacitance must be greater than 0.47  $\mu\text{F}$ . Throughout this document, the nominal derating on these capacitors is 50%. Make sure that the effective capacitance at the pin is greater than 0.47  $\mu\text{F}$ .

## 6 Specifications

### 6.1 Absolute Maximum Ratings

over operating temperature range (unless otherwise noted)<sup>(1)</sup> <sup>(2)</sup>

		MIN	MAX	UNIT
Voltage	V <sub>IN</sub> (for legacy chip only)	–0.3	24	V
	V <sub>IN</sub> (for new chip only)	–0.3	30	
Voltage	V <sub>OUT</sub> (for legacy chip only)	–0.3	5.0	V
Voltage	V <sub>OUT</sub> (for fixed output new chip only)	–0.3	$2 \times V_{OUT(typ)}$ or $V_{IN} + 0.3$ or 5.5 (whichever is lower)	V
Current	Peak output current	Internally limited		
Temperature	Junction, T <sub>J</sub>	–40	150	°C
	Storage, T <sub>stg</sub>	–65	150	

- (1) Stresses beyond those listed under *Absolute Maximum Ratings* may cause permanent damage to the device. These are stress ratings only, which do not imply functional operation of the device at these or any other conditions beyond those indicated under *Recommended Operating Conditions*. Exposure to absolute-maximum-rated conditions for extended periods may affect device reliability.
- (2) All voltage values are with respect to network ground terminal.

### 6.2 ESD Ratings

		VALUE	UNIT
V <sub>(ESD)</sub>	Electrostatic discharge	Human body model (HBM), per ANSI/ESDA/JEDEC JS-001, all pins <sup>(1)</sup>	±2000
		Charged device model (CDM), per JEDEC specification JESD22-C101, all pins <sup>(2)</sup>	±500

- (1) JEDEC document JEP155 states that 500-V HBM allows safe manufacturing with a standard ESD control process.
- (2) JEDEC document JEP157 states that 250-V CDM allows safe manufacturing with a standard ESD control process.

## 6.3 Recommended Operating Conditions

over operating free-air temperature range (unless otherwise noted)<sup>(1)</sup>

		MIN	NOM	MAX	UNIT
V <sub>IN</sub>	Input supply voltage	2.5		24	V
V <sub>OUT</sub>	Output voltage	1.205		5	V
I <sub>OUT</sub>	Output current	0		150	mA
C <sub>IN</sub>	Input capacitor <sup>(2)</sup>	0	0.047		μF
C <sub>OUT</sub>	Output capacitor (for legacy chip only)	0.47	1		
	Output capacitor (for new chip only) <sup>(3)</sup>	1			
T <sub>J</sub>	Operating junction temperature	-40		125	°C

- (1) All voltages are with respect to GND.
- (2) An input capacitor is not required for LDO stability. However, an input capacitor with an effective value of 0.047 μF is recommended to counteract the effect of source resistance and inductance, which may in some cases cause symptoms of system level instability such as ringing or oscillation, especially in the presence of load transients.
- (3) All capacitor values are assumed to derate to 50% of the nominal capacitor value. Maintain an effective output capacitance of 0.47 μF minimum for the stability.

## Thermal Information

THERMAL METRIC <sup>(1)</sup>		Legacy Chip	New Chip	UNIT
		DBV (SOT-23)	DBV (SOT-23)	
		5 PINS	5 PINS	
R <sub>θJA</sub>	Junction-to-ambient thermal resistance	213.1	170.8	°C/W
R <sub>θJC(top)</sub>	Junction-to-case (top) thermal resistance	110.9	68.7	°C/W
R <sub>θJB</sub>	Junction-to-board thermal resistance	97.4	76.7	°C/W
ψ <sub>JT</sub>	Junction-to-top characterization parameter	22.0	10.3	°C/W
ψ <sub>JB</sub>	Junction-to-board characterization parameter	78.4	76.3	°C/W

- (1) For more information about traditional and new thermal metrics, see the [Semiconductor and IC package thermal metrics](#) application report.

## 6.4 Electrical Characteristics

over operating junction temperature range ( $T_J = -40^\circ\text{C}$  to  $125^\circ\text{C}$ ),  $V_{IN} = V_{OUT(nom)} + 1\text{ V}$ ,  $I_{OUT} = 1\text{ mA}$ , and  $C_{OUT} = 1\text{ }\mu\text{F}$  (unless otherwise noted); typical values are at  $T_J = 25^\circ\text{C}$

PARAMETER		TEST CONDITIONS	MIN	TYP	MAX	UNIT
$V_{IN}$	Input voltage range <sup>(1)</sup>	$T_J = 25^\circ\text{C}$			24	V
$V_{OUT}$	Output voltage range <sup>(1)</sup>	$T_J = 25^\circ\text{C}$	1.2		5	V
$V_{OUT}$	DC output accuracy <sup>(1)</sup>	$T_J = 25^\circ\text{C}$	-2		2	%
$I_{GND}$	Ground pin current (legacy chip) <sup>(2)</sup>	$I_{OUT} = 0\text{ mA}$ , $T_J = 25^\circ\text{C}$		3.2	4.5	$\mu\text{A}$
		$I_{OUT} = 100\text{ mA}$ , $T_J = 25^\circ\text{C}$		3.2	5.5	
	Ground pin current (new chip) <sup>(2)</sup>	$I_{OUT} = 0\text{ mA}$ , $T_J = 25^\circ\text{C}$		3.2	4.1	
		$I_{OUT} = 100\text{ mA}$ , $T_J = 25^\circ\text{C}$		3.4	4.5	
$\Delta V_{OUT} (\Delta I_{OUT})$	Load regulation	$V_{OUT} < 3.3\text{ V}$ , $0 < I_{OUT} < 10\text{ mA}$ , $T_J = 25^\circ\text{C}$		10		mV
		$V_{OUT} < 3.3\text{ V}$ , $0 < I_{OUT} < 50\text{ mA}$ , $T_J = 25^\circ\text{C}$		25		
		$V_{OUT} < 3.3\text{ V}$ , $0 < I_{OUT} < 100\text{ mA}$ , $T_J = 25^\circ\text{C}$		33	50	
		$V_{OUT} \geq 3.3\text{ V}$ , $0 < I_{OUT} < 10\text{ mA}$ , $T_J = 25^\circ\text{C}$		7		
		$V_{OUT} \geq 3.3\text{ V}$ , $0 < I_{OUT} < 50\text{ mA}$ , $T_J = 25^\circ\text{C}$		35		
		$V_{OUT} \geq 3.3\text{ V}$ , $0 < I_{OUT} < 100\text{ mA}$ , $T_J = 25^\circ\text{C}$		50	75	
$\Delta V_{OUT} (\Delta V_{IN})$	Line regulation <sup>(1)</sup>	$V_{OUT(nom)} + 1\text{ V} \leq V_{IN} \leq 24\text{ V}$ , $T_J = 25^\circ\text{C}$		20	50	mV
$I_{CL}$	Output current limit (legacy chip)	$V_{OUT} = 0\text{ V}$ , $T_J = 25^\circ\text{C}$	160		1000	mA
	Output current limit (new chip)		160		500	
PSRR	Power-supply ripple rejection	$f = 100\text{ kHz}$ , $C_{OUT} = 10\text{ }\mu\text{F}$		60		dB
$V_{DO}$	Dropout voltage	$V_{IN} = V_{OUT(nom)} - 0.1\text{ V}$ , $I_{OUT} = 10\text{ mA}$ , $T_J = 25^\circ\text{C}$		75		mV
		$V_{IN} = V_{OUT(nom)} - 0.1\text{ V}$ , $I_{OUT} = 50\text{ mA}$ , $T_J = 25^\circ\text{C}$		400		
		$V_{IN} = V_{OUT(nom)} - 0.1\text{ V}$ , $I_{OUT} = 100\text{ mA}$ , $T_J = 25^\circ\text{C}$		850	1100	
$T_J$	Operating junction temperature		-40		125	$^\circ\text{C}$

(1) Minimum  $V_{IN} = V_{OUT} + V_{DO}$  or the value shown for *Input voltage* in this table, whichever is greater.

(2) This device employs a leakage null control circuit. This circuit is active only if output current is less than pass transistor leakage current. The circuit is typically active when output load is less than  $5\text{ }\mu\text{A}$ ,  $V_{IN}$  is greater than  $18\text{ V}$ , and die temperature is greater than  $100^\circ\text{C}$ .

### 6.5 Typical Characteristics

at operating temperature  $T_J = 25^\circ\text{C}$ ,  $V_{IN} = V_{OUT(NOM)} + 1.0\text{ V}$  or  $2.5\text{ V}$  (whichever is greater),  $I_{OUT} = 1\text{ mA}$ ,  $C_{IN} = 1\text{ }\mu\text{F}$ , and  $C_{OUT} = 1\text{ }\mu\text{F}$  (unless otherwise noted)

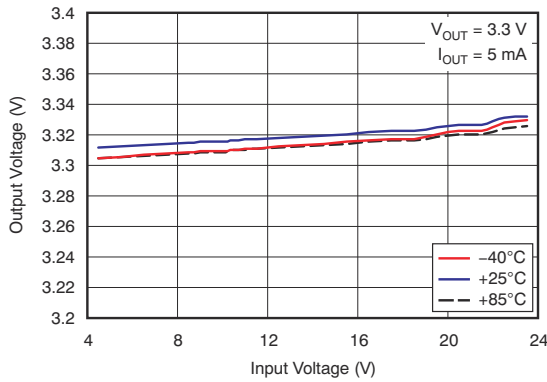

Figure 6-1. Line Regulation for Legacy Chip



Figure 6-2. Line Regulation for New Chip

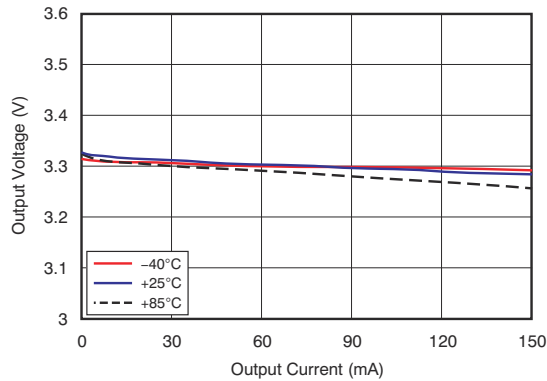

Figure 6-3. Load Regulation ( $V_{OUT} = 3.3\text{ V}$ ) for Legacy Chip



Figure 6-4. Load Regulation ( $V_{OUT} = 3.3\text{ V}$ ) for New Chip

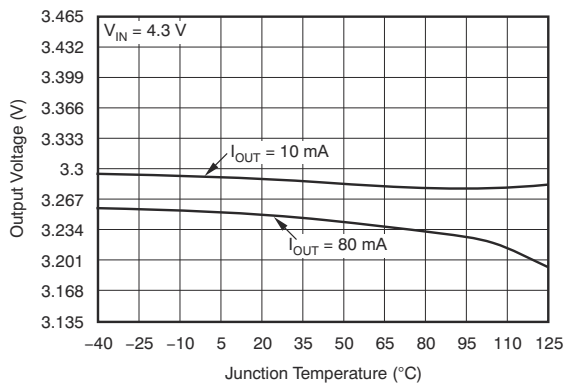

Figure 6-5. Output Voltage vs Junction Temperature for Legacy Chip

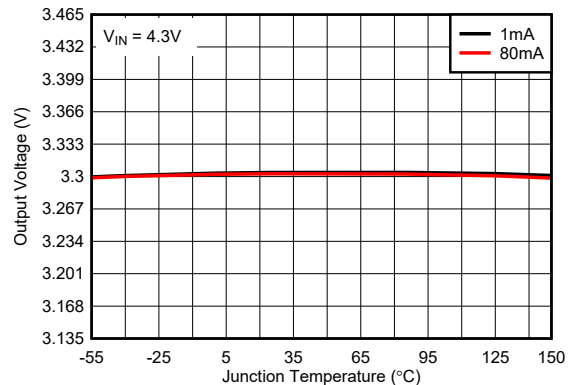

Figure 6-6. Output Voltage vs Junction Temperature for New Chip

### 6.5 Typical Characteristics (continued)

at operating temperature  $T_J = 25^\circ\text{C}$ ,  $V_{IN} = V_{OUT(NOM)} + 1.0\text{ V}$  or  $2.5\text{ V}$  (whichever is greater),  $I_{OUT} = 1\text{ mA}$ ,  $C_{IN} = 1\text{ }\mu\text{F}$ , and  $C_{OUT} = 1\text{ }\mu\text{F}$  (unless otherwise noted)



Figure 6-7. Dropout Voltage vs Input Voltage (TLV70433) for Legacy Chip

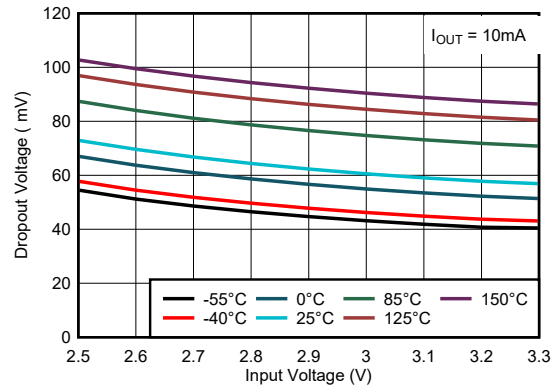

Figure 6-8. Dropout Voltage vs Input Voltage (TLV70433) for New Chip



Figure 6-9. Dropout Voltage vs Output Current for Legacy Chip

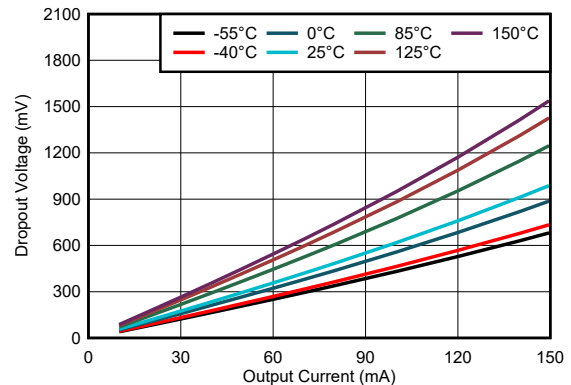

Figure 6-10. Dropout Voltage vs Output Current for New Chip



Figure 6-11. Ground Current vs Junction Temperature for Legacy Chip

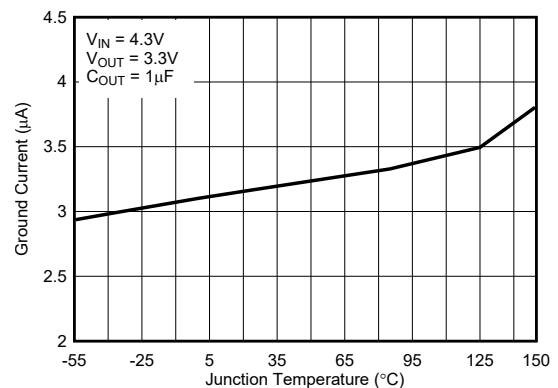
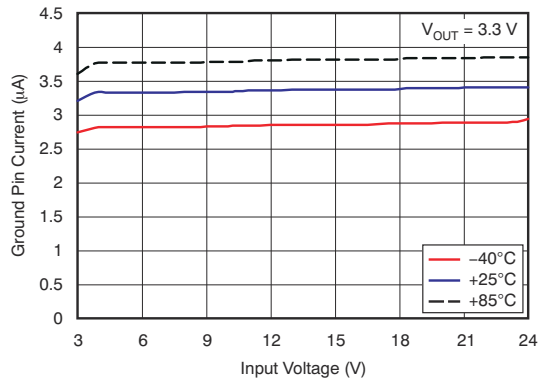

Figure 6-12. Ground Current vs Junction Temperature for New Chip

### 6.5 Typical Characteristics (continued)

at operating temperature  $T_J = 25^\circ\text{C}$ ,  $V_{IN} = V_{OUT(NOM)} + 1.0\text{ V}$  or  $2.5\text{ V}$  (whichever is greater),  $I_{OUT} = 1\text{ mA}$ ,  $C_{IN} = 1\text{ }\mu\text{F}$ , and  $C_{OUT} = 1\text{ }\mu\text{F}$  (unless otherwise noted)



**Figure 6-13. Ground Pin Current vs Input Voltage for Legacy Chip**



**Figure 6-14. Ground Pin Current vs Input Voltage for New Chip**

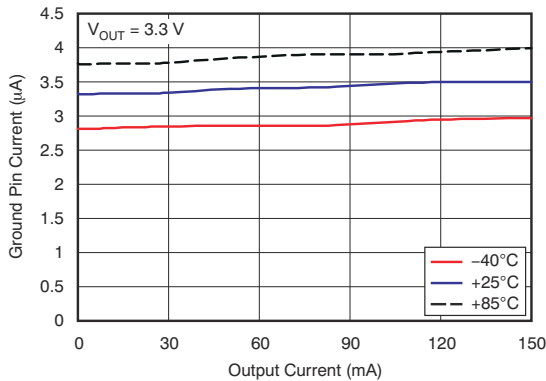

**Figure 6-15. Ground Pin Current vs Load Current for Legacy Chip**

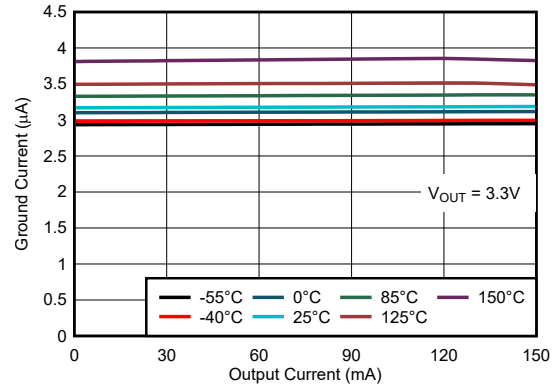

**Figure 6-16. Ground Pin Current vs Load Current for New Chip**

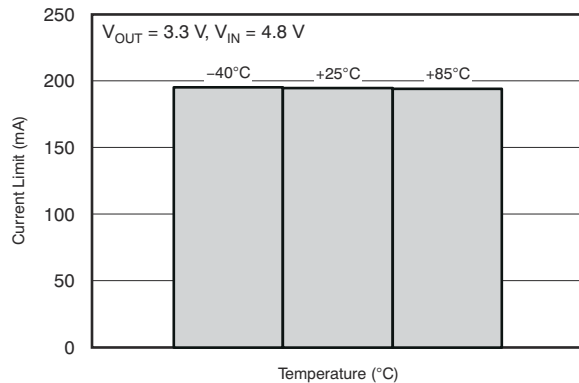

**Figure 6-17. Current Limit vs Junction Temperature for Legacy Chip**



**Figure 6-18. Current Limit vs Junction Temperature for New Chip**

### 6.5 Typical Characteristics (continued)

at operating temperature  $T_J = 25^\circ\text{C}$ ,  $V_{IN} = V_{OUT(NOM)} + 1.0\text{ V}$  or  $2.5\text{ V}$  (whichever is greater),  $I_{OUT} = 1\text{ mA}$ ,  $C_{IN} = 1\text{ }\mu\text{F}$ , and  $C_{OUT} = 1\text{ }\mu\text{F}$  (unless otherwise noted)



**Figure 6-19. Output Spectral Noise Density vs Frequency for Legacy Chip**

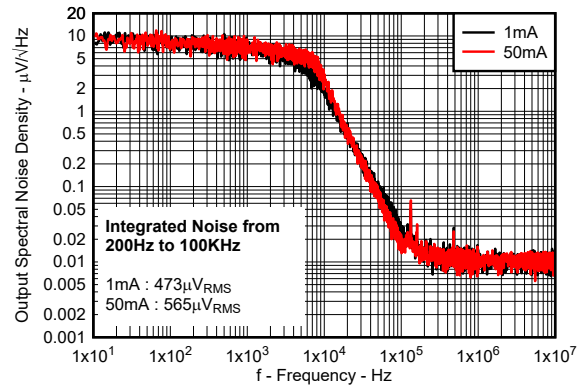

**Figure 6-20. Output Spectral Noise Density vs Frequency for New Chip**

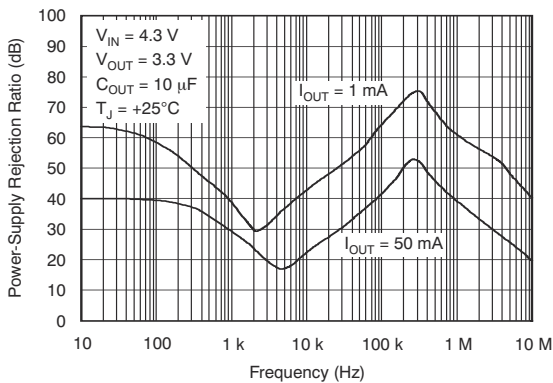

**Figure 6-21. Power-Supply Ripple Rejection vs Frequency for Legacy Chip**



**Figure 6-22. Power-Supply Ripple Rejection vs Frequency for New Chip**



**Figure 6-23. Power-Up, Power-Down for Legacy Chip**



**Figure 6-24. Power-Up, Power-Down for New Chip**

### 6.5 Typical Characteristics (continued)

at operating temperature  $T_J = 25^\circ\text{C}$ ,  $V_{IN} = V_{OUT(NOM)} + 1.0\text{ V}$  or  $2.5\text{ V}$  (whichever is greater),  $I_{OUT} = 1\text{ mA}$ ,  $C_{IN} = 1\text{ }\mu\text{F}$ , and  $C_{OUT} = 1\text{ }\mu\text{F}$  (unless otherwise noted)

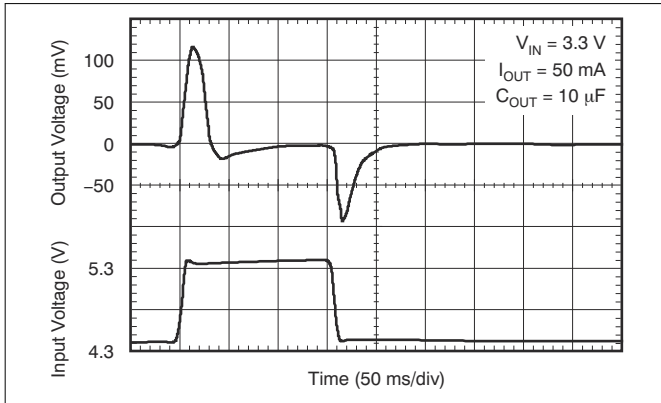

Figure 6-25. Line Transient Response for Legacy Chip



Figure 6-26. Line Transient Response for New Chip

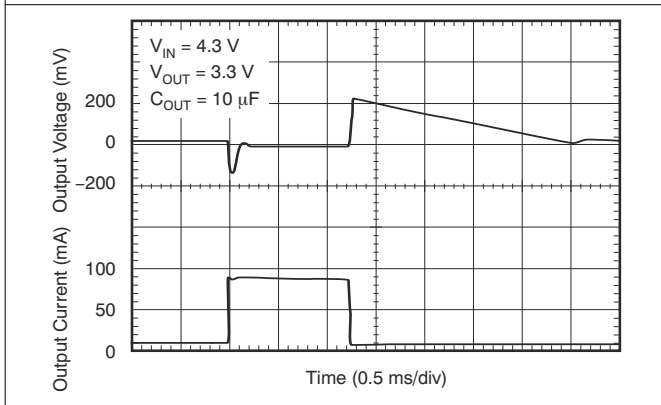

Figure 6-27. Load Transient Response for Legacy Chip

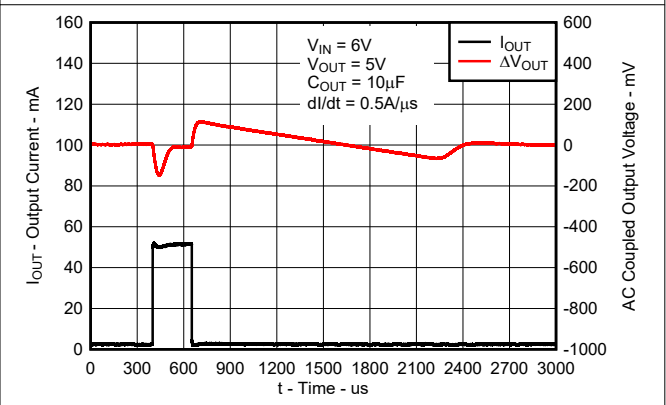

Figure 6-28. Load Transient Response for New Chip

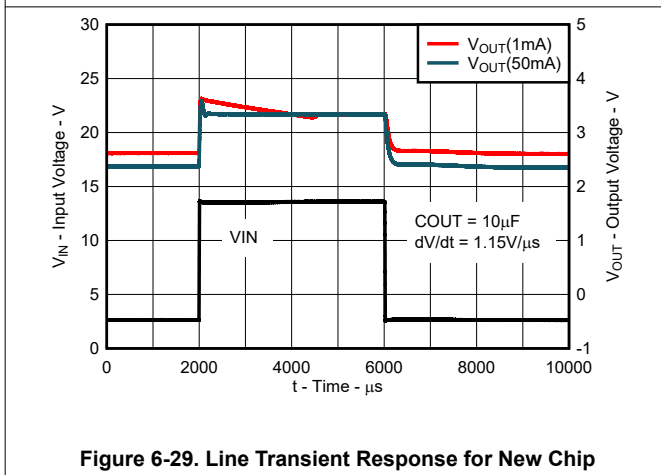

Figure 6-29. Line Transient Response for New Chip

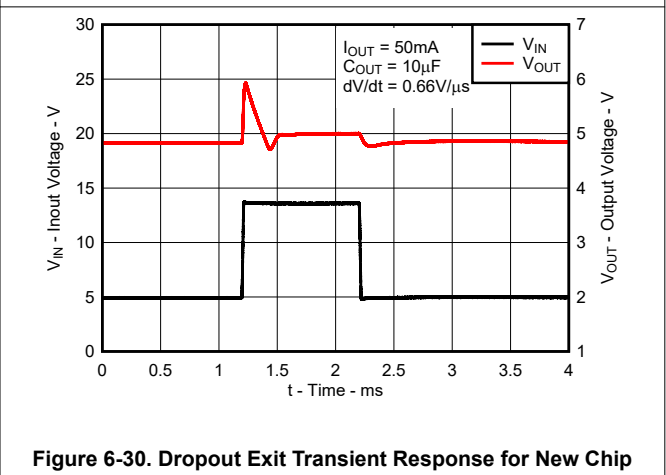

Figure 6-30. Dropout Exit Transient Response for New Chip

## 7 Detailed Description

### 7.1 Overview

The TLV704 low-dropout regulator (LDO) consumes only 3.4  $\mu\text{A}$  of quiescent current across the entire output current range, and offers a wide input voltage range and low-dropout voltage in a small package. The device, which operates over an input range of 2.5 V to 24 V, is stable with any output capacitor greater than or equal to 0.47  $\mu\text{F}$ . The low quiescent current across the complete load current range makes the TLV704 designed for powering battery-operated applications. The TLV704 has internal soft-start to control inrush current into the output capacitor. This LDO also has overcurrent protection during a load-short or fault condition on the output.

### 7.2 Functional Block Diagram



### 7.3 Feature Description

#### 7.3.1 Wide Supply Range

This device has an operational input supply range of 2.5 V to 24 V, allowing for a wide range of applications. This wide supply range is designed for applications that have either large transients or high DC voltage supplies.

#### 7.3.2 Low Quiescent Current

This device only requires 3.4  $\mu\text{A}$  (typical) of quiescent current across the complete load current range (0 mA to 150 mA) and has a maximum current consumption of 4.5  $\mu\text{A}$  (for new device only) at  $-40^\circ\text{C}$  to  $+125^\circ\text{C}$ .

#### 7.3.3 Dropout Voltage ( $V_{\text{DO}}$ )

Dropout voltage ( $V_{\text{DO}}$ ) is defined as the input voltage minus the output voltage ( $V_{\text{IN}} - V_{\text{OUT}}$ ) at the rated output current ( $I_{\text{RATED}}$ ), where the pass transistor is fully on.  $I_{\text{RATED}}$  is the maximum  $I_{\text{OUT}}$  listed in the [Recommended Operating Conditions](#) table. In dropout operation, the pass transistor is in the ohmic or triode region of operation, and acts as a switch. The dropout voltage indirectly specifies a minimum input voltage greater than the nominal programmed output voltage at which the output voltage is expected to stay in regulation. If the input voltage falls to less than the value required to maintain output regulation, the output voltage falls as well.

For a CMOS regulator, the dropout voltage is determined by the drain-source, on-state resistance ( $R_{\text{DS(ON)}}$ ) of the pass transistor. Therefore, if the linear regulator operates at less than the rated current, the dropout voltage for that current scales accordingly. Use [Equation 1](#) to calculate the  $R_{\text{DS(ON)}}$  of the device.

$$R_{\text{DS(ON)}} = \frac{V_{\text{DO}}}{I_{\text{RATED}}} \quad (1)$$

### 7.3.4 Current Limit

The device has an internal current limit circuit that protects the regulator during transient high-load current faults or shorting events. The current limit is a brick-wall scheme. In a high-load current fault, the brick-wall scheme limits the output current to the current limit ( $I_{CL}$ ).  $I_{CL}$  is listed in the [Electrical Characteristics](#) table.

The output voltage is not regulated when the device is in current limit. When a current limit event occurs, the device begins to heat up because of the increase in power dissipation. When the device is in brick-wall current limit, the pass transistor dissipates power  $[(V_{IN} - V_{OUT}) \times I_{CL}]$ . For more information on current limits, see the [Know Your Limits application note](#).

Figure 7-1 shows a diagram of the current limit.



**Figure 7-1. Current Limit**

## 7.4 Device Functional Modes

Table 7-1 provides a quick comparison between the normal, dropout, and disabled modes of operation.

**Table 7-1. Device Functional Mode Comparison**

OPERATING MODE	PARAMETER	
	$V_{IN}$	$I_{OUT}$
Normal	$V_{IN} > V_{OUT(nom)} + V_{DO}$	$I_{OUT} < I_{CL}$
Dropout	$V_{IN} < V_{OUT(nom)} + V_{DO}$	$I_{OUT} < I_{CL}$

### 7.4.1 Normal Operation

The device regulates to the nominal output voltage under the following conditions:

- The input voltage is greater than the nominal output voltage plus the dropout voltage ( $V_{OUT(nom)} + V_{DO}$ )
- The output current is less than the current limit ( $I_{OUT} < I_{CL}$ )
- The device junction temperature is greater than  $-40^{\circ}\text{C}$  and less than  $+125^{\circ}\text{C}$

### 7.4.2 Dropout Operation

If the input voltage is lower than the nominal output voltage plus the specified dropout voltage, but all other conditions are met for normal operation, the device operates in dropout mode. In this mode, the output voltage tracks the input voltage. During this mode, the transient performance of the device becomes significantly degraded because the pass transistor is in the ohmic or triode region, and acts as a switch. Line or load transients in dropout can result in large output voltage deviations.

When the device is in a steady dropout state (defined as when the device is in dropout,  $V_{IN} < V_{OUT(NOM)} + V_{DO}$ , directly after being in a normal regulation state, but *not* during start up), the pass transistor is driven into the ohmic or triode region. When the input voltage returns to a value greater than or equal to the nominal output voltage plus the dropout voltage ( $V_{OUT(NOM)} + V_{DO}$ ), the output voltage can overshoot for a short period of time while the device pulls the pass transistor back into the linear region.

## 8 Application and Implementation

### Note

Information in the following applications sections is not part of the TI component specification, and TI does not warrant its accuracy or completeness. TI's customers are responsible for determining suitability of components for their purposes, as well as validating and testing their design implementation to confirm system functionality.

### 8.1 Application Information

The TLV704 LDO regulator is designed for battery-powered applications and is a good attachment to low-power microcontrollers (such as the [MSP430](#)) because of the device low  $I_Q$  performance across the entire load current range. The ultra-low supply current of the TLV704 maximizes efficiency at light loads, and the high input voltage range and flexibility of output voltage selection in fixed output levels makes the device applicable for supplies such as unconditioned solar panels.

### 8.2 Typical Application



**Figure 8-1. Typical Application**

#### 8.2.1 Design Requirements

Select the desired device based on the output voltage.

Provide an input supply with adequate headroom to account for dropout and output current to account for the GND terminal current, and power the load.

#### 8.2.2 Detailed Design Procedure

##### 8.2.2.1 External Capacitor Requirements

The device is designed to be stable using low equivalent series resistance (ESR) ceramic capacitors at the input and output. Multilayer ceramic capacitors have become the industry standard for these types of applications and are recommended, but must be used with good judgment. Ceramic capacitors that employ X7R-, X5R-, and C0G-rated dielectric materials provide relatively good capacitive stability across temperature, whereas the use of Y5V-rated capacitors is discouraged because of large variations in capacitance.

Regardless of the ceramic capacitor type selected, the effective capacitance varies with operating voltage and temperature. Generally, expect the effective capacitance to decrease by as much as 50%. The input and output capacitors recommended in the [Recommended Operating Conditions](#) table account for an effective capacitance of approximately 50% of the nominal value.

##### 8.2.2.2 Input and Output Capacitor Requirements

Although an input capacitor is not required for stability, good analog design practice is to connect a capacitor from IN to GND. This capacitor counteracts reactive input sources and improves transient response, input ripple, and PSRR. Use an input capacitor if the source impedance is more than 0.5  $\Omega$ . A higher value capacitor can be necessary if large, fast rise-time load or line transients are anticipated or if the device is located several inches from the input power source.

Dynamic performance of the device is improved by using a large output capacitor. Use an output capacitor within the range specified in the [Recommended Operating Conditions](#) table for stability.

### 8.2.2.3 Reverse Current

Excessive reverse current can damage this device. Reverse current flows through the intrinsic body diode of the PMOS pass transistor instead of the normal conducting channel. At high magnitudes, this current flow degrades the long-term reliability of the device.

Conditions where reverse current can occur are outlined in this section, all of which can exceed the absolute maximum rating of  $V_{OUT} \leq V_{IN} + 0.3$  V. These conditions are:

- If the device has a large  $C_{OUT}$  and the input supply collapses with little or no load current
- The output is biased when the input supply is not established
- The output is biased above the input supply

If reverse current flow is expected in the application, external protection is recommended to protect the device. Reverse current is not limited in the device, so external limiting is required if extended reverse voltage operation is anticipated. Limit reverse current to 5% or less of the rated output current of the device in the event this current cannot be avoided.

Figure 8-2 shows one approach for protecting the device.



**Figure 8-2. Example Circuit for Reverse Current Protection Using a Schottky Diode**

### 8.2.2.4 Power Dissipation ( $P_D$ )

Circuit reliability requires consideration of the device power dissipation, location of the circuit on the printed circuit board (PCB), and correct sizing of the thermal plane. The PCB area around the regulator must have few or no other heat-generating devices that cause added thermal stress.

To first-order approximation, power dissipation in the regulator depends on the input-to-output voltage difference and load conditions. The following equation calculates power dissipation ( $P_D$ ).

$$P_D = (V_{IN} - V_{OUT}) \times I_{OUT} \quad (2)$$

#### Note

Power dissipation can be minimized, and therefore greater efficiency can be achieved, by correct selection of the system voltage rails. For the lowest power dissipation, use the minimum input voltage required for correct output regulation.

For devices with a thermal pad, the primary heat conduction path for the device package is through the thermal pad to the PCB. Solder the thermal pad to a copper pad area under the device. This pad area must contain an array of plated vias that conduct heat to additional copper planes for increased heat dissipation.

The maximum power dissipation determines the maximum allowable ambient temperature ( $T_A$ ) for the device. According to the following equation, power dissipation and junction temperature are most often related by the junction-to-ambient thermal resistance ( $R_{\theta JA}$ ) of the combined PCB and device package and the temperature of the ambient air ( $T_A$ ).

$$T_J = T_A + (R_{\theta JA} \times P_D) \quad (3)$$

Thermal resistance ( $R_{\theta JA}$ ) is highly dependent on the heat-spreading capability built into the particular PCB design, and therefore varies according to the total copper area, copper weight, and location of the planes. The junction-to-ambient thermal resistance listed in the [Thermal Information](#) table is determined by the JEDEC standard PCB and copper-spreading area, and is used as a relative measure of package thermal performance.

### 8.2.2.5 Estimating Junction Temperature

The JEDEC standard now recommends the use of psi ( $\Psi$ ) thermal metrics to estimate the junction temperatures of the linear regulator when in-circuit on a typical PCB board application. These metrics are not thermal resistance parameters and instead offer a practical and relative way to estimate junction temperature. These psi metrics are determined to be significantly independent of the copper area available for heat-spreading. The [Thermal Information](#) table lists the primary thermal metrics, which are the junction-to-top characterization parameter ( $\psi_{JT}$ ) and junction-to-board characterization parameter ( $\psi_{JB}$ ). These parameters provide two methods for calculating the junction temperature ( $T_J$ ), as described in the following equations. Use the junction-to-top characterization parameter ( $\psi_{JT}$ ) with the temperature at the center-top of device package ( $T_T$ ) to calculate the junction temperature. Use the junction-to-board characterization parameter ( $\psi_{JB}$ ) with the PCB surface temperature 1 mm from the device package ( $T_B$ ) to calculate the junction temperature.

$$T_J = T_T + \psi_{JT} \times P_D \quad (4)$$

where:

- $P_D$  is the dissipated power
- $T_T$  is the temperature at the center-top of the device package

$$T_J = T_B + \psi_{JB} \times P_D \quad (5)$$

where:

- $T_B$  is the PCB surface temperature measured 1 mm from the device package and centered on the package edge

For detailed information on the thermal metrics and how to use them, see the [Semiconductor and IC Package Thermal Metrics application note](#).

### 8.2.3 Application Curves

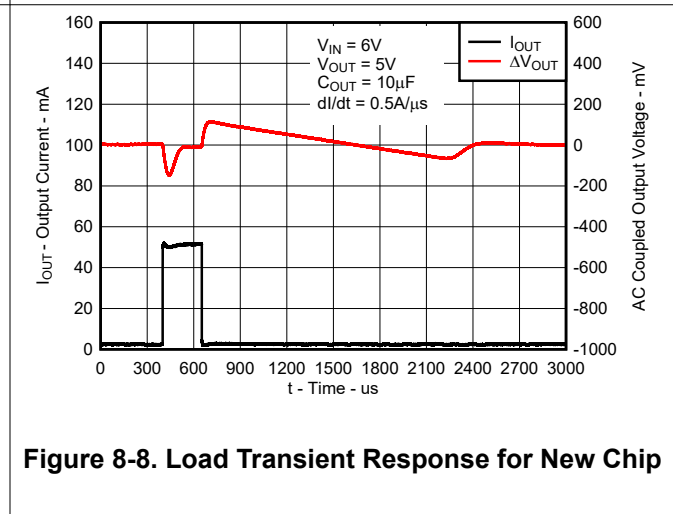
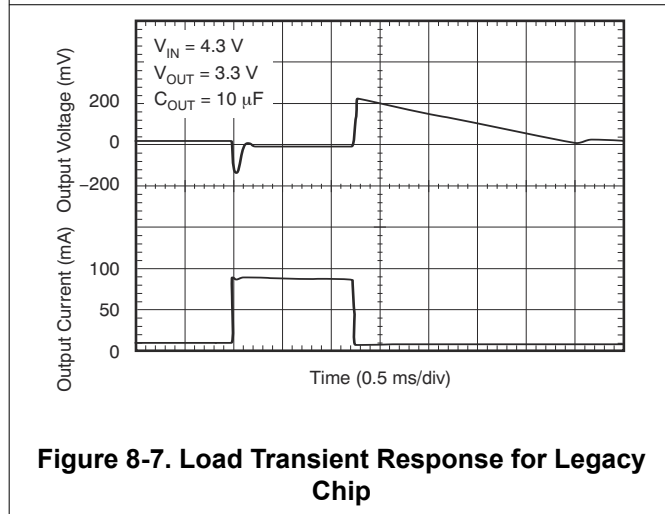
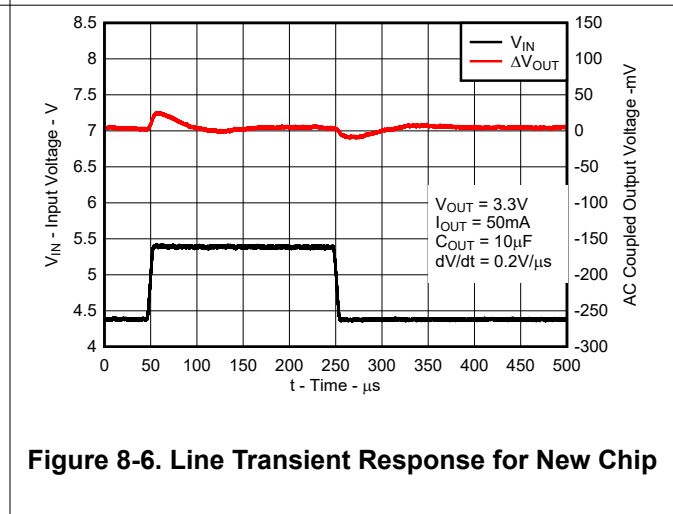
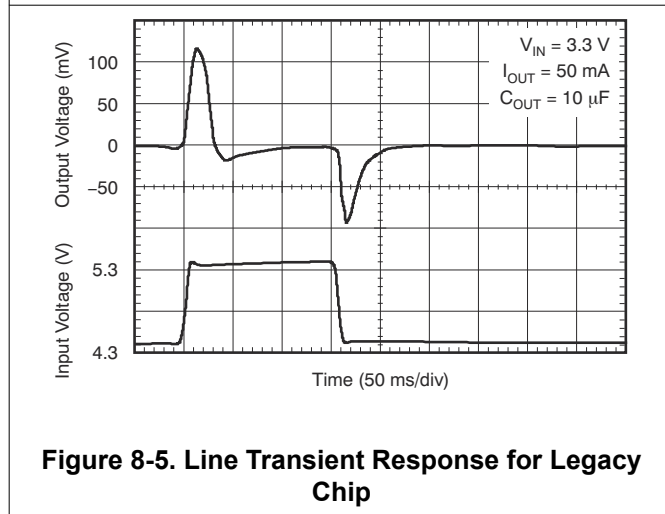
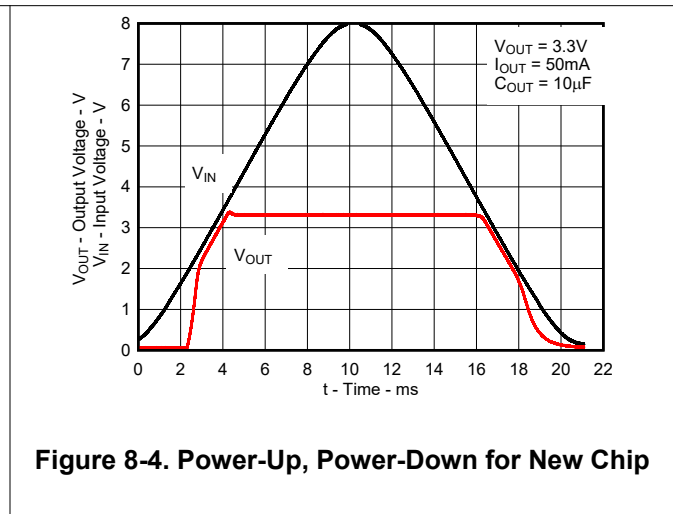
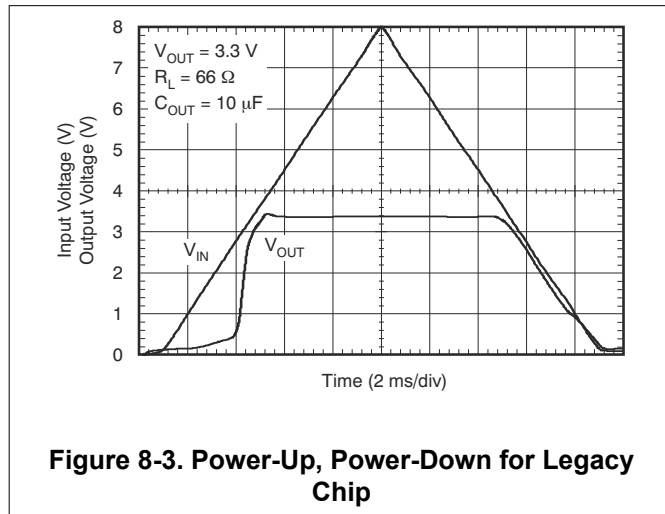



**Figure 8-9. Line Transient Response for New Chip**

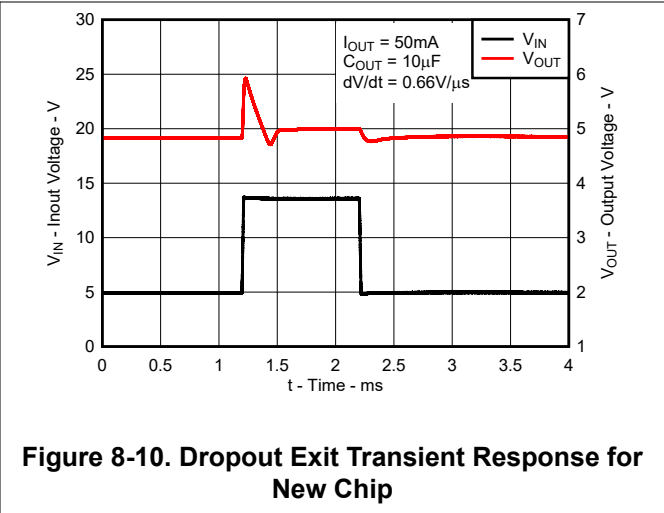

**Figure 8-10. Dropout Exit Transient Response for New Chip**

### 8.3 Best Design Practices

Place at least one 0.47- $\mu$ F capacitor as close as possible to the OUT and GND pins of the regulator.

Do not connect the output capacitor to the regulator using a long, thin trace.

Connect an input capacitor as close as possible to the IN and GND pins of the regulator for best performance.

Do not exceed the absolute maximum ratings.

## 8.4 Power Supply Recommendations

The TLV704 is designed to operate from an input voltage supply range between 2.5 V and 24 V. The input voltage range must provide adequate headroom for the device to have a regulated output. Inductive impedances between the input supply and the IN pin can create significant voltage excursions at the IN pin during start-up or load transient events. If inductive impedances are unavoidable, use an input capacitor.

## 8.5 Layout

### 8.5.1 Layout Guidelines

For best overall performance, place all circuit components on the same side of the printed-circuit-board and as near as practical to the respective LDO pin connections. Place ground return connections for the input and output capacitors as close to the GND pin as possible, using wide, component-side, copper planes. Do not use vias and long traces to create LDO circuit connections to the input capacitor, output capacitor, or the resistor divider because this practice negatively affects system performance. This grounding and layout scheme minimizes inductive parasitics, and thereby reduces load-current transients, minimizes noise, and increases circuit stability. A ground reference plane is also recommended and is either embedded in the PCB or located on the bottom side of the PCB opposite the components. This reference plane serves to assure accuracy of the output voltage and shield the LDO from noise.

#### 8.5.1.1 Power Dissipation

To provide reliable operation, worst-case junction temperature must not exceed 125°C. This restriction limits the power dissipation the regulator can handle in any given application. To make sure the junction temperature is within acceptable limits, calculate the maximum allowable dissipation,  $P_{D(max)}$ , and the actual dissipation,  $P_D$ , which must be less than or equal to  $P_{D(max)}$ .

The maximum-power-dissipation limit is determined using [Equation 6](#):

$$P_{D(max)} = \frac{T_{Jmax} - T_A}{R_{\theta JA}} \quad (6)$$

where:

- $T_{Jmax}$  is the maximum allowable junction temperature
- $R_{\theta JA}$  is the thermal resistance junction-to-ambient for the package (see the [Thermal Information](#) table)
- $T_A$  is the ambient temperature

The regulator dissipation is calculated using [Equation 7](#):

$$P_D = (V_{IN} - V_{OUT}) \times I_{OUT} \quad (7)$$

### 8.5.2 Layout Example



**Figure 8-11. Layout Example for the DBV Package**

## 9 Device and Documentation Support

### 9.1 Device Support

#### 9.1.1 Development Support

##### 9.1.1.1 Evaluation Module

An evaluation module (EVM) is available to assist in the initial circuit performance evaluation using the TLV704. The [TLV70433DBVEVM-712 evaluation module](#) (and [related user guide](#)) can be requested at the Texas Instruments website through the product folders or purchased directly from the [TI eStore](#).

#### 9.1.2 Device Nomenclature

**Table 9-1. Available Options<sup>(1)</sup>**

PRODUCT	V <sub>OUT</sub>
TLV704xxyyyz Legacy chip	<b>xx</b> is the nominal output voltage (for example 33 = 3.3 V). <b>yyy</b> is the package designator. <b>z</b> is the package quantity.
TLV704xxyyyzM3 New chip	<b>xx</b> is the nominal output voltage (for example 33 = 3.3 V). <b>yyy</b> is the package designator. <b>z</b> is the package quantity. <b>M3</b> is a suffix designator for newer chip redesigns, fabricated on the latest TI process technology.

(1) For the most current package and ordering information, see the Package Option Addendum at the end of this document, or visit the device product folder at [www.ti.com](http://www.ti.com).

## 9.2 Documentation Support

### 9.2.1 Related Documentation

For related documentation see the following:

- Texas Instruments, [TLV70433DBVEVM-712, TLV70433PKEVM-712 Evaluation Modules user guide](#)

### 9.3 Receiving Notification of Documentation Updates

To receive notification of documentation updates, navigate to the device product folder on [ti.com](http://ti.com). Click on *Subscribe to updates* to register and receive a weekly digest of any product information that has changed. For change details, review the revision history included in any revised document.

## 9.4 Support Resources

[TI E2E™ support forums](#) are an engineer's go-to source for fast, verified answers and design help — straight from the experts. Search existing answers or ask your own question to get the quick design help you need.

Linked content is provided "AS IS" by the respective contributors. They do not constitute TI specifications and do not necessarily reflect TI's views; see TI's [Terms of Use](#).

## 9.5 Trademarks

TI E2E™ is a trademark of Texas Instruments.

All trademarks are the property of their respective owners.

## 9.6 Electrostatic Discharge Caution



This integrated circuit can be damaged by ESD. Texas Instruments recommends that all integrated circuits be handled with appropriate precautions. Failure to observe proper handling and installation procedures can cause damage.

ESD damage can range from subtle performance degradation to complete device failure. Precision integrated circuits may be more susceptible to damage because very small parametric changes could cause the device not to meet its published specifications.

## 9.7 Glossary

[TI Glossary](#) This glossary lists and explains terms, acronyms, and definitions.

## 10 Mechanical, Packaging, and Orderable Information

The following pages include mechanical, packaging, and orderable information. This information is the most current data available for the designated devices. This data is subject to change without notice and revision of this document. For browser-based versions of this data sheet, refer to the left-hand navigation.

**PACKAGING INFORMATION**

Orderable part number	Status (1)	Material type (2)	Package   Pins	Package qty   Carrier	RoHS (3)	Lead finish/ Ball material (4)	MSL rating/ Peak reflow (5)	Op temp (°C)	Part marking (6)
<a href="#">TLV70418DBVR</a>	Active	Production	SOT-23 (DBV)   5	3000   LARGE T&R	Yes	NIPDAU	Level-1-260C-UNLIM	-40 to 125	1NG
TLV70418DBVR.A	Active	Production	SOT-23 (DBV)   5	3000   LARGE T&R	Yes	NIPDAU	Level-1-260C-UNLIM	-40 to 125	1NG
<a href="#">TLV70430DBVR</a>	Active	Production	SOT-23 (DBV)   5	3000   LARGE T&R	Yes	NIPDAU	Level-1-260C-UNLIM	-40 to 125	QUQ
TLV70430DBVR.A	Active	Production	SOT-23 (DBV)   5	3000   LARGE T&R	Yes	NIPDAU	Level-1-260C-UNLIM	-40 to 125	QUQ
TLV70430DBVRG4	Active	Production	SOT-23 (DBV)   5	3000   LARGE T&R	Yes	NIPDAU	Level-1-260C-UNLIM	-40 to 125	QUQ
TLV70430DBVRG4.A	Active	Production	SOT-23 (DBV)   5	3000   LARGE T&R	Yes	NIPDAU	Level-1-260C-UNLIM	-40 to 125	QUQ
<a href="#">TLV70430DBVT</a>	Active	Production	SOT-23 (DBV)   5	250   SMALL T&R	Yes	NIPDAU	Level-1-260C-UNLIM	-40 to 125	QUQ
TLV70430DBVT.A	Active	Production	SOT-23 (DBV)   5	250   SMALL T&R	Yes	NIPDAU	Level-1-260C-UNLIM	-40 to 125	QUQ
<a href="#">TLV70433DBVR</a>	Active	Production	SOT-23 (DBV)   5	3000   LARGE T&R	Yes	NIPDAU   SN	Level-1-260C-UNLIM	-40 to 125	PAO
TLV70433DBVR.A	Active	Production	SOT-23 (DBV)   5	3000   LARGE T&R	Yes	NIPDAU	Level-1-260C-UNLIM	-40 to 125	PAO
TLV70433DBVRG4	Active	Production	SOT-23 (DBV)   5	3000   LARGE T&R	Yes	NIPDAU	Level-1-260C-UNLIM	-40 to 125	PAO
TLV70433DBVRG4.A	Active	Production	SOT-23 (DBV)   5	3000   LARGE T&R	Yes	NIPDAU	Level-1-260C-UNLIM	-40 to 125	PAO
<a href="#">TLV70433DBVRM3</a>	Active	Production	SOT-23 (DBV)   5	3000   LARGE T&R	Yes	NIPDAU	Level-1-260C-UNLIM	-40 to 125	PAO
TLV70433DBVRM3.A	Active	Production	SOT-23 (DBV)   5	3000   LARGE T&R	Yes	NIPDAU	Level-1-260C-UNLIM	-40 to 125	PAO
<a href="#">TLV70433DBVT</a>	Active	Production	SOT-23 (DBV)   5	250   SMALL T&R	Yes	NIPDAU   SN	Level-1-260C-UNLIM	-40 to 125	PAO
TLV70433DBVT.A	Active	Production	SOT-23 (DBV)   5	250   SMALL T&R	Yes	NIPDAU	Level-1-260C-UNLIM	-40 to 125	PAO
<a href="#">TLV704345DBVR</a>	Active	Production	SOT-23 (DBV)   5	3000   LARGE T&R	Yes	NIPDAU	Level-1-260C-UNLIM	-40 to 125	13T
TLV704345DBVR.A	Active	Production	SOT-23 (DBV)   5	3000   LARGE T&R	Yes	NIPDAU	Level-1-260C-UNLIM	-40 to 125	13T
<a href="#">TLV704345DBVRM3</a>	Active	Production	SOT-23 (DBV)   5	3000   LARGE T&R	Yes	NIPDAU	Level-1-260C-UNLIM	-40 to 125	13T
TLV704345DBVRM3.A	Active	Production	SOT-23 (DBV)   5	3000   LARGE T&R	Yes	NIPDAU	Level-1-260C-UNLIM	-40 to 125	13T
<a href="#">TLV704345DBVT</a>	Active	Production	SOT-23 (DBV)   5	250   SMALL T&R	Yes	NIPDAU	Level-1-260C-UNLIM	-40 to 125	13T
TLV704345DBVT.A	Active	Production	SOT-23 (DBV)   5	250   SMALL T&R	Yes	NIPDAU	Level-1-260C-UNLIM	-40 to 125	13T
<a href="#">TLV70436DBVR</a>	Active	Production	SOT-23 (DBV)   5	3000   LARGE T&R	Yes	NIPDAU   SN	Level-1-260C-UNLIM	-40 to 125	PAW
TLV70436DBVR.A	Active	Production	SOT-23 (DBV)   5	3000   LARGE T&R	Yes	NIPDAU	Level-1-260C-UNLIM	-40 to 125	PAW
TLV70436DBVRG4	Active	Production	SOT-23 (DBV)   5	3000   LARGE T&R	Yes	NIPDAU	Level-1-260C-UNLIM	-40 to 125	PAW
TLV70436DBVRG4.A	Active	Production	SOT-23 (DBV)   5	3000   LARGE T&R	Yes	NIPDAU	Level-1-260C-UNLIM	-40 to 125	PAW
<a href="#">TLV70436DBVRM3</a>	Active	Production	SOT-23 (DBV)   5	3000   LARGE T&R	Yes	NIPDAU	Level-1-260C-UNLIM	-40 to 125	PAW
TLV70436DBVRM3.A	Active	Production	SOT-23 (DBV)   5	3000   LARGE T&R	Yes	NIPDAU	Level-1-260C-UNLIM	-40 to 125	PAW
<a href="#">TLV70436DBVT</a>	Active	Production	SOT-23 (DBV)   5	250   SMALL T&R	Yes	NIPDAU	Level-1-260C-UNLIM	-40 to 125	PAW

Orderable part number	Status (1)	Material type (2)	Package   Pins	Package qty   Carrier	RoHS (3)	Lead finish/ Ball material (4)	MSL rating/ Peak reflow (5)	Op temp (°C)	Part marking (6)
TLV70436DBVT.A	Active	Production	SOT-23 (DBV)   5	250   SMALL T&R	Yes	NIPDAU	Level-1-260C-UNLIM	-40 to 125	PAW
<a href="#">TLV70450DBVR</a>	Active	Production	SOT-23 (DBV)   5	3000   LARGE T&R	Yes	NIPDAU	Level-1-260C-UNLIM	-40 to 125	PAX
TLV70450DBVR.A	Active	Production	SOT-23 (DBV)   5	3000   LARGE T&R	Yes	NIPDAU	Level-1-260C-UNLIM	-40 to 125	PAX
TLV70450DBVRG4	Active	Production	SOT-23 (DBV)   5	3000   LARGE T&R	Yes	NIPDAU	Level-1-260C-UNLIM	-40 to 125	PAX
TLV70450DBVRG4.A	Active	Production	SOT-23 (DBV)   5	3000   LARGE T&R	Yes	NIPDAU	Level-1-260C-UNLIM	-40 to 125	PAX
<a href="#">TLV70450DBVRM3</a>	Active	Production	SOT-23 (DBV)   5	3000   LARGE T&R	Yes	NIPDAU	Level-1-260C-UNLIM	-40 to 125	PAX
TLV70450DBVRM3.A	Active	Production	SOT-23 (DBV)   5	3000   LARGE T&R	Yes	NIPDAU	Level-1-260C-UNLIM	-40 to 125	PAX
<a href="#">TLV70450DBVT</a>	Active	Production	SOT-23 (DBV)   5	250   SMALL T&R	Yes	NIPDAU	Level-1-260C-UNLIM	-40 to 125	PAX
TLV70450DBVT.A	Active	Production	SOT-23 (DBV)   5	250   SMALL T&R	Yes	NIPDAU	Level-1-260C-UNLIM	-40 to 125	PAX

(1) **Status:** For more details on status, see our [product life cycle](#).

(2) **Material type:** When designated, preproduction parts are prototypes/experimental devices, and are not yet approved or released for full production. Testing and final process, including without limitation quality assurance, reliability performance testing, and/or process qualification, may not yet be complete, and this item is subject to further changes or possible discontinuation. If available for ordering, purchases will be subject to an additional waiver at checkout, and are intended for early internal evaluation purposes only. These items are sold without warranties of any kind.

(3) **RoHS values:** Yes, No, RoHS Exempt. See the [TI RoHS Statement](#) for additional information and value definition.

(4) **Lead finish/Ball material:** Parts may have multiple material finish options. Finish options are separated by a vertical ruled line. Lead finish/Ball material values may wrap to two lines if the finish value exceeds the maximum column width.

(5) **MSL rating/Peak reflow:** The moisture sensitivity level ratings and peak solder (reflow) temperatures. In the event that a part has multiple moisture sensitivity ratings, only the lowest level per JEDEC standards is shown. Refer to the shipping label for the actual reflow temperature that will be used to mount the part to the printed circuit board.

(6) **Part marking:** There may be an additional marking, which relates to the logo, the lot trace code information, or the environmental category of the part.

Multiple part markings will be inside parentheses. Only one part marking contained in parentheses and separated by a "~" will appear on a part. If a line is indented then it is a continuation of the previous line and the two combined represent the entire part marking for that device.

**Important Information and Disclaimer:** The information provided on this page represents TI's knowledge and belief as of the date that it is provided. TI bases its knowledge and belief on information provided by third parties, and makes no representation or warranty as to the accuracy of such information. Efforts are underway to better integrate information from third parties. TI has taken and continues to take reasonable steps to provide representative and accurate information but may not have conducted destructive testing or chemical analysis on incoming materials and chemicals. TI and TI suppliers consider certain information to be proprietary, and thus CAS numbers and other limited information may not be available for release.

In no event shall TI's liability arising out of such information exceed the total purchase price of the TI part(s) at issue in this document sold by TI to Customer on an annual basis.

## TAPE AND REEL INFORMATION



### QUADRANT ASSIGNMENTS FOR PIN 1 ORIENTATION IN TAPE



\*All dimensions are nominal

Device	Package Type	Package Drawing	Pins	SPQ	Reel Diameter (mm)	Reel Width W1 (mm)	A0 (mm)	B0 (mm)	K0 (mm)	P1 (mm)	W (mm)	Pin1 Quadrant
TLV70418DBVR	SOT-23	DBV	5	3000	180.0	8.4	3.2	3.2	1.4	4.0	8.0	Q3
TLV70418DBVR	SOT-23	DBV	5	3000	180.0	8.4	3.2	3.2	1.4	4.0	8.0	Q3
TLV70430DBVR	SOT-23	DBV	5	3000	180.0	8.4	3.2	3.2	1.4	4.0	8.0	Q3
TLV70430DBVR	SOT-23	DBV	5	3000	180.0	8.4	3.2	3.2	1.4	4.0	8.0	Q3
TLV70430DBVRG4	SOT-23	DBV	5	3000	180.0	8.4	3.2	3.2	1.4	4.0	8.0	Q3
TLV70430DBVRG4	SOT-23	DBV	5	3000	180.0	8.4	3.2	3.2	1.4	4.0	8.0	Q3
TLV70430DBVT	SOT-23	DBV	5	250	178.0	8.4	3.23	3.17	1.37	4.0	8.0	Q3
TLV70433DBVR	SOT-23	DBV	5	3000	180.0	8.4	3.2	3.2	1.4	4.0	8.0	Q3
TLV70433DBVR	SOT-23	DBV	5	3000	180.0	8.4	3.2	3.2	1.4	4.0	8.0	Q3
TLV70433DBVRG4	SOT-23	DBV	5	3000	180.0	8.4	3.2	3.2	1.4	4.0	8.0	Q3
TLV70433DBVRG4	SOT-23	DBV	5	3000	180.0	8.4	3.2	3.2	1.4	4.0	8.0	Q3
TLV70433DBVRM3	SOT-23	DBV	5	3000	180.0	8.4	3.2	3.2	1.4	4.0	8.0	Q3
TLV70433DBVRM3	SOT-23	DBV	5	3000	180.0	8.4	3.2	3.2	1.4	4.0	8.0	Q3
TLV70433DBVT	SOT-23	DBV	5	250	180.0	8.4	3.2	3.2	1.4	4.0	8.0	Q3
TLV70433DBVT	SOT-23	DBV	5	250	180.0	8.4	3.2	3.2	1.4	4.0	8.0	Q3
TLV704345DBVR	SOT-23	DBV	5	3000	180.0	8.4	3.2	3.2	1.4	4.0	8.0	Q3

Device	Package Type	Package Drawing	Pins	SPQ	Reel Diameter (mm)	Reel Width W1 (mm)	A0 (mm)	B0 (mm)	K0 (mm)	P1 (mm)	W (mm)	Pin1 Quadrant
TLV704345DBVR	SOT-23	DBV	5	3000	180.0	8.4	3.2	3.2	1.4	4.0	8.0	Q3
TLV704345DBVRM3	SOT-23	DBV	5	3000	180.0	8.4	3.2	3.2	1.4	4.0	8.0	Q3
TLV704345DBVRM3	SOT-23	DBV	5	3000	180.0	8.4	3.2	3.2	1.4	4.0	8.0	Q3
TLV704345DBVT	SOT-23	DBV	5	250	178.0	8.4	3.23	3.17	1.37	4.0	8.0	Q3
TLV70436DBVR	SOT-23	DBV	5	3000	180.0	8.4	3.2	3.2	1.4	4.0	8.0	Q3
TLV70436DBVR	SOT-23	DBV	5	3000	180.0	8.4	3.2	3.2	1.4	4.0	8.0	Q3
TLV70436DBVRG4	SOT-23	DBV	5	3000	180.0	8.4	3.2	3.2	1.4	4.0	8.0	Q3
TLV70436DBVRG4	SOT-23	DBV	5	3000	180.0	8.4	3.2	3.2	1.4	4.0	8.0	Q3
TLV70436DBVRM3	SOT-23	DBV	5	3000	180.0	8.4	3.2	3.2	1.4	4.0	8.0	Q3
TLV70436DBVRM3	SOT-23	DBV	5	3000	180.0	8.4	3.2	3.2	1.4	4.0	8.0	Q3
TLV70436DBVT	SOT-23	DBV	5	250	178.0	8.4	3.23	3.17	1.37	4.0	8.0	Q3
TLV70450DBVR	SOT-23	DBV	5	3000	180.0	8.4	3.2	3.2	1.4	4.0	8.0	Q3
TLV70450DBVR	SOT-23	DBV	5	3000	180.0	8.4	3.2	3.2	1.4	4.0	8.0	Q3
TLV70450DBVRG4	SOT-23	DBV	5	3000	180.0	8.4	3.2	3.2	1.4	4.0	8.0	Q3
TLV70450DBVRG4	SOT-23	DBV	5	3000	180.0	8.4	3.2	3.2	1.4	4.0	8.0	Q3
TLV70450DBVRM3	SOT-23	DBV	5	3000	180.0	8.4	3.2	3.2	1.4	4.0	8.0	Q3
TLV70450DBVRM3	SOT-23	DBV	5	3000	180.0	8.4	3.2	3.2	1.4	4.0	8.0	Q3
TLV70450DBVT	SOT-23	DBV	5	250	180.0	8.4	3.2	3.2	1.4	4.0	8.0	Q3
TLV70450DBVT	SOT-23	DBV	5	250	180.0	8.4	3.2	3.2	1.4	4.0	8.0	Q3

**TAPE AND REEL BOX DIMENSIONS**

\*All dimensions are nominal

Device	Package Type	Package Drawing	Pins	SPQ	Length (mm)	Width (mm)	Height (mm)
TLV70418DBVR	SOT-23	DBV	5	3000	210.0	185.0	35.0
TLV70418DBVR	SOT-23	DBV	5	3000	210.0	185.0	35.0
TLV70430DBVR	SOT-23	DBV	5	3000	210.0	185.0	35.0
TLV70430DBVR	SOT-23	DBV	5	3000	210.0	185.0	35.0
TLV70430DBVRG4	SOT-23	DBV	5	3000	210.0	185.0	35.0
TLV70430DBVRG4	SOT-23	DBV	5	3000	210.0	185.0	35.0
TLV70430DBVT	SOT-23	DBV	5	250	180.0	180.0	18.0
TLV70433DBVR	SOT-23	DBV	5	3000	210.0	185.0	35.0
TLV70433DBVR	SOT-23	DBV	5	3000	210.0	185.0	35.0
TLV70433DBVRG4	SOT-23	DBV	5	3000	210.0	185.0	35.0
TLV70433DBVRG4	SOT-23	DBV	5	3000	210.0	185.0	35.0
TLV70433DBVRM3	SOT-23	DBV	5	3000	210.0	185.0	35.0
TLV70433DBVRM3	SOT-23	DBV	5	3000	210.0	185.0	35.0
TLV70433DBVT	SOT-23	DBV	5	250	210.0	185.0	35.0
TLV70433DBVT	SOT-23	DBV	5	250	210.0	185.0	35.0
TLV704345DBVR	SOT-23	DBV	5	3000	210.0	185.0	35.0
TLV704345DBVR	SOT-23	DBV	5	3000	210.0	185.0	35.0
TLV704345DBVRM3	SOT-23	DBV	5	3000	210.0	185.0	35.0

Device	Package Type	Package Drawing	Pins	SPQ	Length (mm)	Width (mm)	Height (mm)
TLV704345DBVRM3	SOT-23	DBV	5	3000	210.0	185.0	35.0
TLV704345DBVT	SOT-23	DBV	5	250	180.0	180.0	18.0
TLV70436DBVR	SOT-23	DBV	5	3000	210.0	185.0	35.0
TLV70436DBVR	SOT-23	DBV	5	3000	210.0	185.0	35.0
TLV70436DBVRG4	SOT-23	DBV	5	3000	210.0	185.0	35.0
TLV70436DBVRG4	SOT-23	DBV	5	3000	210.0	185.0	35.0
TLV70436DBVRM3	SOT-23	DBV	5	3000	210.0	185.0	35.0
TLV70436DBVRM3	SOT-23	DBV	5	3000	210.0	185.0	35.0
TLV70436DBVT	SOT-23	DBV	5	250	180.0	180.0	18.0
TLV70450DBVR	SOT-23	DBV	5	3000	210.0	185.0	35.0
TLV70450DBVR	SOT-23	DBV	5	3000	210.0	185.0	35.0
TLV70450DBVRG4	SOT-23	DBV	5	3000	210.0	185.0	35.0
TLV70450DBVRG4	SOT-23	DBV	5	3000	210.0	185.0	35.0
TLV70450DBVRM3	SOT-23	DBV	5	3000	210.0	185.0	35.0
TLV70450DBVRM3	SOT-23	DBV	5	3000	210.0	185.0	35.0
TLV70450DBVT	SOT-23	DBV	5	250	210.0	185.0	35.0
TLV70450DBVT	SOT-23	DBV	5	250	210.0	185.0	35.0



# EXAMPLE BOARD LAYOUT

DBV0005A

SOT-23 - 1.45 mm max height

SMALL OUTLINE TRANSISTOR



LAND PATTERN EXAMPLE  
EXPOSED METAL SHOWN  
SCALE:15X



SOLDER MASK DETAILS

4214839/K 08/2024

NOTES: (continued)

- 6. Publication IPC-7351 may have alternate designs.
- 7. Solder mask tolerances between and around signal pads can vary based on board fabrication site.

# EXAMPLE STENCIL DESIGN

DBV0005A

SOT-23 - 1.45 mm max height

SMALL OUTLINE TRANSISTOR



SOLDER PASTE EXAMPLE  
BASED ON 0.125 mm THICK STENCIL  
SCALE:15X

4214839/K 08/2024

NOTES: (continued)

8. Laser cutting apertures with trapezoidal walls and rounded corners may offer better paste release. IPC-7525 may have alternate design recommendations.
9. Board assembly site may have different recommendations for stencil design.

## IMPORTANT NOTICE AND DISCLAIMER

TI PROVIDES TECHNICAL AND RELIABILITY DATA (INCLUDING DATASHEETS), DESIGN RESOURCES (INCLUDING REFERENCE DESIGNS), APPLICATION OR OTHER DESIGN ADVICE, WEB TOOLS, SAFETY INFORMATION, AND OTHER RESOURCES "AS IS" AND WITH ALL FAULTS, AND DISCLAIMS ALL WARRANTIES, EXPRESS AND IMPLIED, INCLUDING WITHOUT LIMITATION ANY IMPLIED WARRANTIES OF MERCHANTABILITY, FITNESS FOR A PARTICULAR PURPOSE OR NON-INFRINGEMENT OF THIRD PARTY INTELLECTUAL PROPERTY RIGHTS.

These resources are intended for skilled developers designing with TI products. You are solely responsible for (1) selecting the appropriate TI products for your application, (2) designing, validating and testing your application, and (3) ensuring your application meets applicable standards, and any other safety, security, regulatory or other requirements.

These resources are subject to change without notice. TI grants you permission to use these resources only for development of an application that uses the TI products described in the resource. Other reproduction and display of these resources is prohibited. No license is granted to any other TI intellectual property right or to any third party intellectual property right. TI disclaims responsibility for, and you fully indemnify TI and its representatives against any claims, damages, costs, losses, and liabilities arising out of your use of these resources.

TI's products are provided subject to [TI's Terms of Sale](#), [TI's General Quality Guidelines](#), or other applicable terms available either on [ti.com](#) or provided in conjunction with such TI products. TI's provision of these resources does not expand or otherwise alter TI's applicable warranties or warranty disclaimers for TI products. Unless TI explicitly designates a product as custom or customer-specified, TI products are standard, catalog, general purpose devices.

TI objects to and rejects any additional or different terms you may propose.

Copyright © 2026, Texas Instruments Incorporated

Last updated 10/2025