

## TLV62150x 4-V to 17-V 1-A Step-Down Converter In 3x3 QFN Package

### 1 Features

- DCS-Control™ Topology
- Input Voltage Range: 4 V to 17 V
- Up to 1-A Output Current
- Adjustable Output Voltage from 0.9 to 5 V
- Pin-Selectable Output Voltage (nominal, + 5%)
- Programmable Soft Start and Tracking
- Seamless Power Save Mode Transition
- Quiescent Current of 19  $\mu$ A (Typical)
- Selectable Operating Frequency
- Power Good Output
- 100% Duty Cycle Mode
- Short Circuit Protection
- Over Temperature Protection
- For Improved Feature Set, see [TPS62150](#)
- Pin to Pin compatible with [TLV62130](#)
- Available in a 3-mm  $\times$  3-mm, VQFN-16 Package

### 2 Applications

- Standard 12-V Rail Supplies
- POL Supplies from Single or Multiple Li-Ion Batteries
- Appliances, Building Automation
- Mobile PC's, Tablets, Modems, Cameras
- TV, Set-top Boxes, Audio

### 3 Description

The TLV62150x device is an easy-to-use synchronous step-down DC-DC converter optimized for applications with high power density. A high switching frequency of typically 2.5 MHz allows the use of small inductors and provides fast transient response as well as high output voltage accuracy by use of the DCS-Control™ topology.

With their wide operating input voltage range of 4 V to 17 V, the devices are ideally suited for systems powered from either a Li-Ion or other batteries as well as from 12 V intermediate power rails. It supports up to 1-A continuous output current at output voltages between 0.9 V and 5 V (with 100% duty cycle mode).

The output voltage startup ramp is controlled by the soft-start pin, which allows operation as either a standalone power supply or in tracking configurations. Power sequencing is also possible by configuring the Enable and open-drain Power Good pins.

In Power Save Mode, the devices draw quiescent current of about 19  $\mu$ A from VIN. Power Save Mode, entered automatically and seamlessly if load is small, maintains high efficiency over the entire load range. In Shutdown Mode, the device is turned off and shutdown current consumption is less than 2  $\mu$ A.

The device is packaged in a 16-pin VQFN package measuring 3 mm  $\times$  3 mm (RGT).

#### Device Information<sup>(1)</sup>

PART NUMBER	PACKAGE	BODY SIZE (NOM)
TLV62150	VQFN (16)	3.00 mm $\times$ 3.00 mm
TLV62150A		

(1) For all available packages, see the orderable addendum at the end of the data sheet.

#### Typical Application Schematic

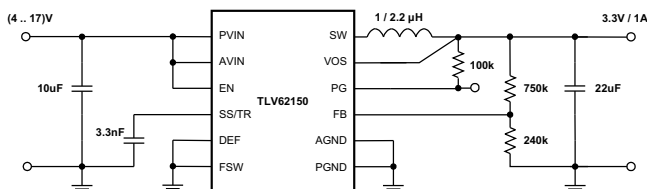

#### Efficiency vs Output Current

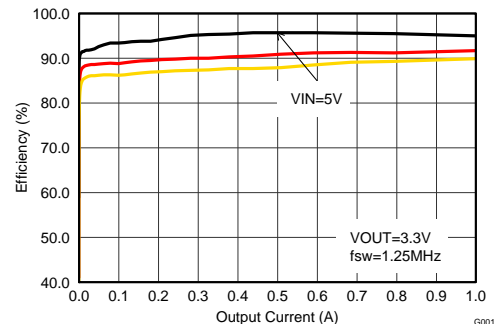

## Table of Contents

<b>1 Features</b> ..... 1 <b>2 Applications</b> ..... 1 <b>3 Description</b> ..... 1 <b>4 Revision History</b> ..... 2 <b>5 Device Comparison Table</b> ..... 4 <b>6 Pin Configuration and Functions</b> ..... 4 <b>7 Specifications</b> ..... 5 7.1 Absolute Maximum Ratings ..... 5 7.2 ESD Ratings ..... 5 7.3 Recommended Operating Conditions ..... 5 7.4 Thermal Information ..... 5 7.5 Electrical Characteristics ..... 6 7.6 Typical Characteristics ..... 7 <b>8 Detailed Description</b> ..... 8 8.1 Overview ..... 8 8.2 Functional Block Diagram ..... 8 8.3 Feature Description ..... 9 8.4 Device Functional Modes ..... 10 <b>9 Application and Implementation</b> ..... 13	9.1 Application Information ..... 13 9.2 Typical Application ..... 13 9.3 System Examples ..... 23 <b>10 Power Supply Recommendations</b> ..... 27 <b>11 Layout</b> ..... 28 11.1 Layout Guidelines ..... 28 11.2 Layout Example ..... 28 11.3 Thermal Considerations ..... 29 <b>12 Device and Documentation Support</b> ..... 30 12.1 Device Support ..... 30 12.2 Related Links ..... 30 12.3 Documentation Support ..... 30 12.4 Receiving Notification of Documentation Updates ..... 30 12.5 Community Resources ..... 30 12.6 Trademarks ..... 30 12.7 Electrostatic Discharge Caution ..... 30 12.8 Glossary ..... 31 <b>13 Mechanical, Packaging, and Orderable Information</b> ..... 31
---	--

## 4 Revision History

NOTE: Page numbers for previous revisions may differ from page numbers in the current version.

Changes from Revision D (August 2015) to Revision E	Page
• Added Pin to Pin compatibility to Features	1
• Added items to Applications list	1
• Corrected temperatures in <i>Thermal Information</i>	5
• Added <i>Power Good Pin Logic Tables 1 and 2</i>	9
• Added <i>Receiving Notification of Documentation Updates</i>	30

Changes from Revision C (June 2015) to Revision D	Page
• Changed Power Good Threshold Voltage, Falling (%V <sub>OUT</sub> ) MAX spec from 93% to 94%	6

Changes from Revision B (June 2013) to Revision C	Page
• Added <i>ESD Ratings table, Feature Description section, Device Functional Modes, Application and Implementation section, Power Supply Recommendations section, Layout section, Device and Documentation Support section, and Mechanical, Packaging, and Orderable Information section</i>	1

Changes from Revision A (February 2013) to Revision B	Page
• Added new device version TLV62150A to data sheet	1
• Added text to Power Good section regarding the TLV62150A function	9
• Added additional option to the footnote for Pin-Selectable Output Voltage (DEF) section	10
• Added text to Frequency Selection (FSW) section regarding pin control	10
• Added text to Tracking Function section for clarification	17
• Changed schematic for <i>Figure 38</i>	24

---

**Changes from Original (February 2012) to Revision A****Page**

- 
- Added text to Terminal Functions table to clarify Description for AGND, PGND, and Exposed Thermal Pad. .... 4
  - Added text to Power Save Mode Operation section for clarification. .... 11
  - Changed text in the Layout Considerations section for clarification..... 28
-

## 5 Device Comparison Table

PART NUMBER	OUTPUT VOLTAGE	POWER GOOD LOGIC LEVEL (EN=Low)
TLV62150	Adjustable	High Impedance
TLV62150A	Adjustable	Low

## 6 Pin Configuration and Functions

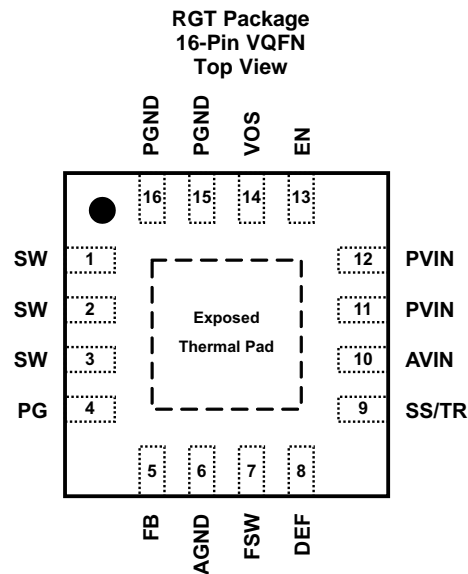

### Pin Functions

PIN <sup>(1)</sup>		I/O	DESCRIPTION
NAME	NO.		
AGND	6	—	Analog Ground. Must be connected directly to the Exposed Thermal Pad and common ground plane.
AVIN	10	I	Supply voltage for control circuitry. Connect to same source as PVIN.
DEF	8	I	Output Voltage Scaling (Low = nominal, High = nominal + 5%) <sup>(2)</sup>
EN	13	I	Enable input (High = enabled, Low = disabled) <sup>(2)</sup>
FB	5	I	Voltage feedback. Connect resistive voltage divider to this pin.
FSW	7	I	Switching Frequency Select (Low ≈ 2.5 MHz, High ≈ 1.25 MHz <sup>(3)</sup> for typical operation) <sup>(2)</sup>
SW	1,2,3	O	Switch node, which is connected to the internal MOSFET switches. Connect inductor between SW and output capacitor.
PG	4	O	Output power good (High = V <sub>OUT</sub> ready, Low = V <sub>OUT</sub> below nominal regulation) ; open drain (requires pull-up resistor)
PGND	15,16	—	Power ground. Must be connected directly to the Exposed Thermal Pad and common ground plane.
PVIN	11,12	I	Supply voltage for power stage. Connect to same source as AVIN.
SS/TR	9	I	Soft-Start / Tracking Pin. An external capacitor connected to this pin sets the internal voltage reference rise time. It can be used for tracking and sequencing.
VOS	14	I	Output voltage sense pin and connection for the control loop circuitry.
Exposed Thermal Pad	—	—	Must be connected to AGND (pin 6), PGND (pin 15,16) and common ground plane. See the <a href="#">Layout Example</a> . Must be soldered to achieve appropriate power dissipation and mechanical reliability.

(1) For more information about connecting pins, see [Detailed Description](#) and [Application and Implementation](#) sections.

(2) An internal pull-down resistor keeps logic level low, if pin is floating.

(3) Connect FSW to V<sub>OUT</sub> or PG in this case.

## 7 Specifications

### 7.1 Absolute Maximum Ratings

over operating free-air temperature range (unless otherwise noted) <sup>(1)</sup>

		MIN	MAX	UNIT
Pin voltage <sup>(2)</sup>	AVIN, PVIN	−0.3	20	V
	EN, SS/TR	−0.3	V <sub>IN</sub> +0.3	
	SW	−0.3	V <sub>IN</sub> +0.3	V
	DEF, FSW, FB, PG, VOS	−0.3	7	V
Power Good sink current	PG		10	mA
Operating junction temperature	T <sub>J</sub>	−40	125	°C
Storage temperature	T <sub>stg</sub>	−65	150	

- (1) Stresses beyond those listed under *Absolute Maximum Ratings* may cause permanent damage to the device. These are stress ratings only, which do not imply functional operation of the device at these or any other conditions beyond those indicated under *Recommended Operating Conditions*. Exposure to absolute-maximum-rated conditions for extended periods may affect device reliability.
- (2) All voltages are with respect to network ground terminal.

### 7.2 ESD Ratings

		VALUE	UNIT
V <sub>ESD</sub> Electrostatic discharge <sup>(1)</sup>	Human body model (HBM), per ANSI/ESDA/JEDEC JS-001, all pins <sup>(2)</sup>	±2000	V
	Charged device model (CDM), per JEDEC specification JESD22-C101, all pins <sup>(3)</sup>	±500	

- (1) ESD testing is performed according to the respective JESD22 JEDEC standard.
- (2) JEDEC document JEP155 states that 500-V HBM allows safe manufacturing with a standard ESD control process.
- (3) JEDEC document JEP157 states that 250-V CDM allows safe manufacturing with a standard ESD control process.

### 7.3 Recommended Operating Conditions

		MIX	MAX	UNIT
Supply Voltage		4	17	V
Temperature Range, T <sub>A</sub>		−40	85	°C
Operating junction temperature, T <sub>J</sub>		−40	125	

### 7.4 Thermal Information

THERMAL METRIC <sup>(1)</sup>		TLV62150	UNIT
		RGT [VQFN]	
		16 PINS	
R <sub>θJA</sub>	Junction-to-ambient thermal resistance	45	°C/W
R <sub>θJC(top)</sub>	Junction-to-case (top) thermal resistance	53.6	°C/W
R <sub>θJB</sub>	Junction-to-board thermal resistance	17.4	°C/W
ψ <sub>JT</sub>	Junction-to-top characterization parameter	1.1	°C/W
ψ <sub>JB</sub>	Junction-to-board characterization parameter	17.4	°C/W
R <sub>θJC(bot)</sub>	Junction-to-case (bottom) thermal resistance	4.5	°C/W

- (1) For more information about traditional and new thermal metrics, see the *Semiconductor and IC Package Thermal Metrics* application report, [SPRA953](#).

## 7.5 Electrical Characteristics

over operating free-air temperature range ( $T_A = -40^\circ\text{C}$  to  $85^\circ\text{C}$ ), typical values at  $V_{IN} = 12\text{ V}$  and  $T_A = 25^\circ\text{C}$  (unless otherwise noted)

PARAMETER		TEST CONDITIONS	MIN	TYP	MAX	UNIT
<b>POWER SUPPLY</b>						
$V_{IN}$	Input Voltage Range <sup>(1)</sup>		4		17	V
$I_Q$	Operating Quiescent Current	EN=High, $I_{OUT}=0\text{ mA}$ , device not switching		19	27	$\mu\text{A}$
$I_{SD}$	Shutdown Current <sup>(2)</sup>	EN=Low		1.5	4	$\mu\text{A}$
$V_{UVLO}$	Undervoltage Lockout Threshold	Falling Input Voltage (PWM mode operation)	2.6	2.7	2.8	V
		Hysteresis		200		mV
$T_{SD}$	Thermal Shutdown Temperature			160		$^\circ\text{C}$
	Thermal Shutdown Hysteresis			20		
<b>CONTROL (EN, DEF, FSW, SS/TR, PG)</b>						
$V_H$	High Level Input Threshold Voltage (EN, DEF, FSW)		0.9			V
$V_L$	Low Level Input Threshold Voltage (EN, DEF, FSW)				0.3	V
$I_{LKG}$	Input Leakage Current (EN, DEF, FSW)	EN= $V_{IN}$ or GND; DEF, FSW= $V_{OUT}$ or GND		0.01	1	$\mu\text{A}$
$V_{TH\_PG}$	Power Good Threshold Voltage	Rising (% $V_{OUT}$ )	92%	95%	98%	
		Falling (% $V_{OUT}$ )	87%	90%	94%	
$V_{OL\_PG}$	Power Good Output Low	$I_{PG}=-2\text{ mA}$		0.07	0.3	V
$I_{LKG\_PG}$	Input Leakage Current (PG)	$V_{PG}=1.8\text{ V}$		1	400	nA
$I_{SS/TR}$	SS/TR Pin Source Current		2.3	2.5	2.7	$\mu\text{A}$
<b>POWER SWITCH</b>						
$R_{DS(ON)}$	High-Side MOSFET ON-Resistance	$V_{IN}\geq 6\text{ V}$		90		$\text{m}\Omega$
	Low-Side MOSFET ON-Resistance	$V_{IN}\geq 6\text{ V}$		40		$\text{m}\Omega$
$I_{LIMF}$	High-Side MOSFET Forward Current Limit <sup>(3)</sup>	$V_{IN}=12\text{ V}$ , $T_A=25^\circ\text{C}$	1.4	1.7		A
<b>OUTPUT</b>						
$I_{LKG\_FB}$	Input Leakage Current (FB)	$V_{FB}=0.8\text{ V}$		1	100	nA
$V_{OUT}$	Output Voltage Range	$V_{IN} \geq V_{OUT}$	0.9		5	V
	DEF (Output Voltage Programming)	DEF=0 (GND)		$V_{OUT}$		
		DEF=1 ( $V_{OUT}$ )		$V_{OUT}+5\%$		
	Initial Output Voltage Accuracy <sup>(4)</sup>	PWM mode operation, $V_{IN} \geq V_{OUT} + 1\text{ V}$	780	800	820	mV
	Load Regulation <sup>(5)</sup>	$V_{IN}=12\text{ V}$ , $V_{OUT}=3.3\text{ V}$ , PWM mode operation		0.05		%/A
Line Regulation <sup>(5)</sup>	$4\text{ V} \leq V_{IN} \leq 17\text{ V}$ , $V_{OUT}=3.3\text{ V}$ , $I_{OUT}=1\text{ A}$ , PWM mode operation		0.02		%/V	

(1) The device is still functional down to Under Voltage Lockout (see parameter VUVLO).

(2) Current into AVIN+PVIN pin.

(3) This is the static current limit. It can be temporarily higher in applications due to internal propagation delay (see [Current Limit and Short Circuit Protection](#)).

(4) This is the accuracy provided by the device itself (line and load regulation effects are not included).

(5) Line and load regulation depend on external component selection and layout (see [Figure 20](#) and [Figure 21](#)).

## 7.6 Typical Characteristics

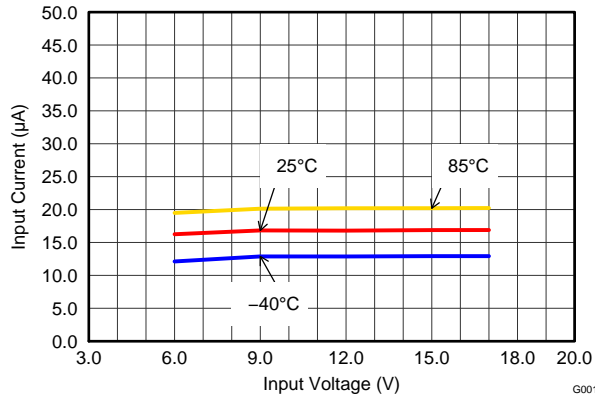

Figure 1. Quiescent Current

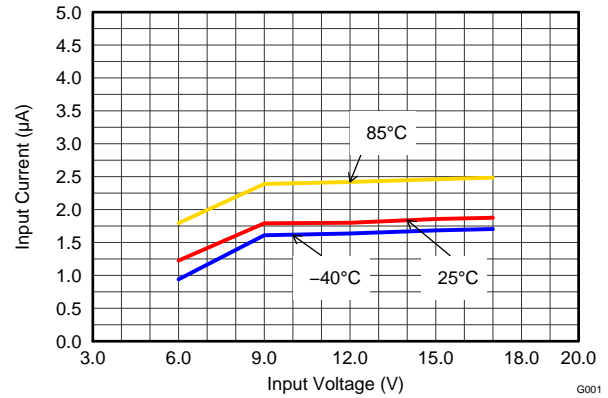

Figure 2. Shutdown Current

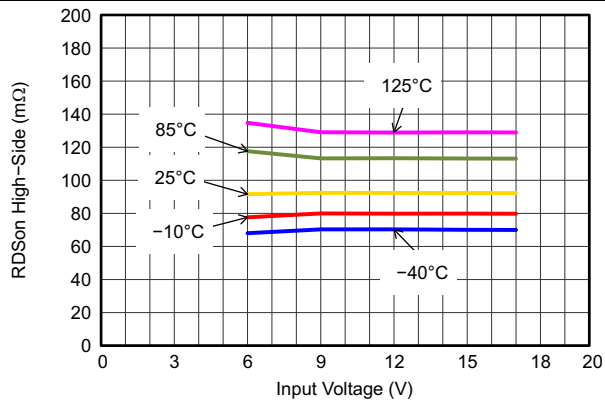

Figure 3. High-Side Switch Resistance

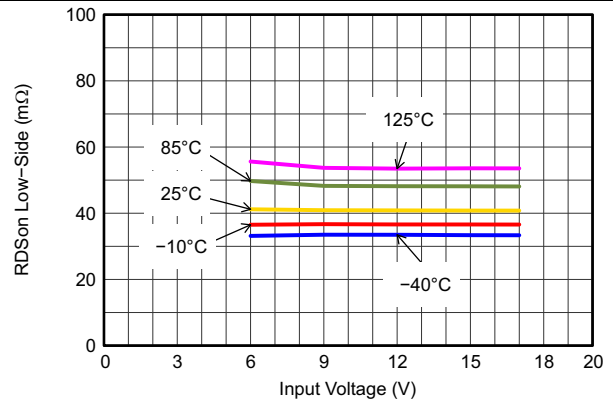

Figure 4. Low-Side Switch Resistance

## 8 Detailed Description

### 8.1 Overview

The TLV62150 synchronous switched-mode power converters are based on DCS-Control™ (Direct Control with Seamless Transition into Power Save Mode), an advanced regulation topology, that combines the advantages of hysteretic, voltage mode and current mode control including an AC loop directly associated to the output voltage. This control loop takes information about output voltage changes and feeds it directly to a fast comparator stage. It sets the switching frequency, which is constant for steady state operating conditions, and provides immediate response to dynamic load changes. To get accurate DC load regulation, a voltage feedback loop is used. The internally compensated regulation network achieves fast and stable operation with small external components and low ESR capacitors.

The DCS-Control™ topology supports Pulse Width Modulation (PWM) mode for medium and heavy load conditions and a Power Save Mode at light loads. During PWM, it operates at its nominal switching frequency in continuous conduction mode. This frequency is typically about 2.5 MHz or 1.25 MHz with a controlled frequency variation depending on the input voltage. If the load current decreases, the converter enters Power Save Mode to sustain high efficiency down to very light loads. In Power Save Mode the switching frequency decreases linearly with the load current. Since DCS-Control™ supports both operation modes within one single building block, the transition from PWM to Power Save Mode is seamless without effects on the output voltage.

An internal current limit supports nominal output currents of up to 1 A.

The TLV62150 offers both excellent DC voltage and superior load transient regulation, combined with very low output voltage ripple, minimizing interference with RF circuits.

### 8.2 Functional Block Diagram

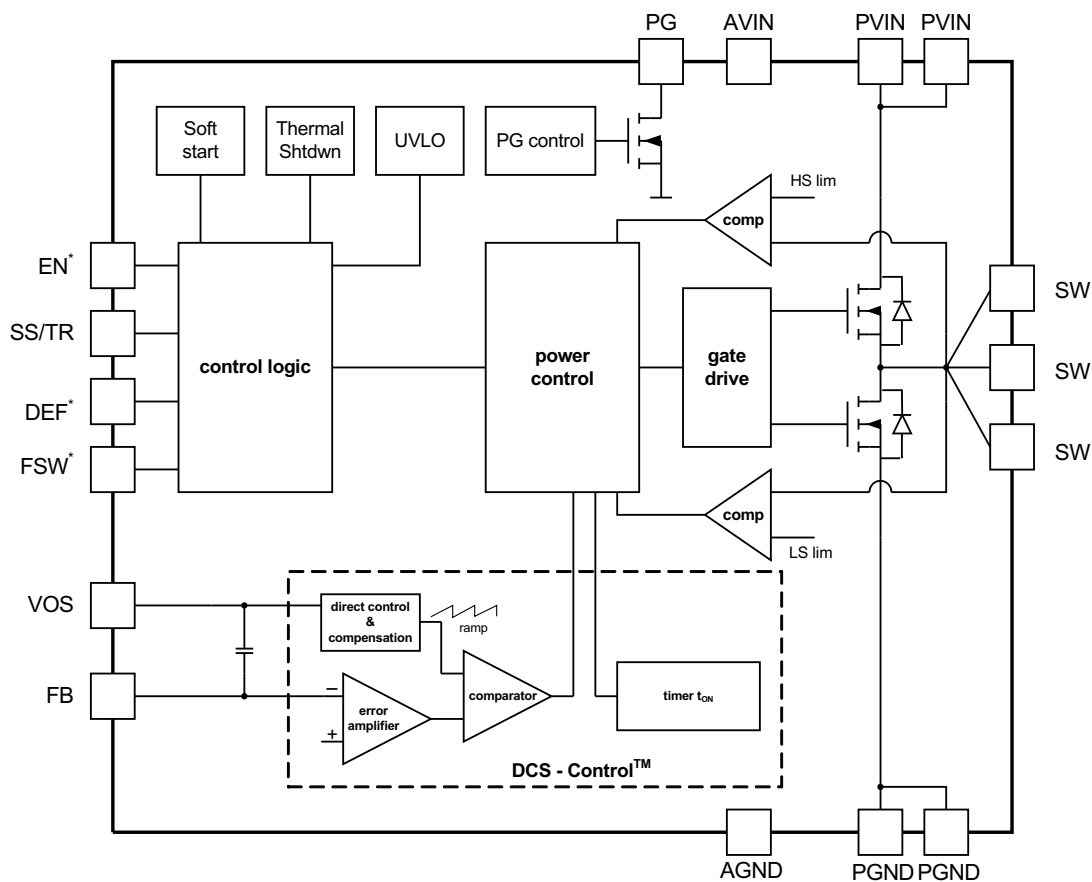

Copyright © 2016, Texas Instruments Incorporated



## 8.3 Feature Description

### 8.3.1 Enable / Shutdown (EN)

When Enable (EN) is set High, the device starts operation. Shutdown is forced if EN is pulled Low with a shutdown current of typically 1.5  $\mu$ A. During shutdown, the internal power MOSFETs as well as the entire control circuitry are turned off. The EN signal must be set externally to High or Low. An internal pull-down resistor of about 400 k $\Omega$  is connected and keeps EN logic low, if the pin is floating. It is disconnected if the pin is High.

Connecting the EN pin to an appropriate output signal of another power rail provides sequencing of multiple power rails.

### 8.3.2 Soft Start / Tracking (SS/TR)

The internal soft start circuitry controls the output voltage slope during startup. This avoids excessive inrush current and ensures a controlled output voltage rise time. It also prevents unwanted voltage drops from high-impedance power sources or batteries. When EN is set to start device operation, the device starts switching after a delay of about 50 $\mu$ s and VOUT rises with a slope controlled by an external capacitor connected to the SS/TR pin. See [Figure 32](#) and [Figure 33](#) for typical startup operation.

Using a very small capacitor (or leaving SS/TR pin un-connected) provides fastest startup behavior. There is no theoretical limit for the longest startup time. The TLV62150 can start into a pre-biased output. During monotonic pre-biased startup, the low-side MOSFET is not allowed to turn on until the device's internal ramp sets an output voltage above the pre-bias voltage. If the device is set to shutdown (EN=GND), undervoltage lockout or thermal shutdown, an internal resistor pulls the SS/TR pin down to ensure a proper low level. Returning from those states causes a new startup sequence as set by the SS/TR connection.

A voltage supplied to SS/TR can be used for tracking a master voltage. The output voltage will follow this voltage in both directions up and down (see [Application and Implementation](#)).

### 8.3.3 Power Good (PG)

The TLV62150 has a built in power good (PG) function to indicate whether the output voltage has reached its appropriate level or not. The PG signal can be used for startup sequencing of multiple rails. The PG pin is an open-drain output that requires a pull-up resistor (to any voltage below 7 V). It can sink 2 mA of current and maintain its specified logic low level. With TLV62150 it is high impedance when the device is turned off due to EN, UVLO or thermal shutdown. TLV62150A features PG=Low in this case and can be used to actively discharge Vout (see [Figure 37](#)). VIN must remain present for the PG pin to stay Low. See [SLVA644](#) for application details. If not used, the PG pin should be connected to GND but may be left floating.

**Table 1. Power Good Pin Logic Table (TLV62150)**

Device State		PG Logic Status	
		High Impedance	Low
Enable (EN=High)	$V_{FB} \geq V_{TH\_PG}$	√	
	$V_{FB} \leq V_{TH\_PG}$		√
Shutdown (EN=Low)		√	
UVLO	$0.7V < V_{IN} < V_{UVLO}$	√	
Thermal Shutdown	$T_J > T_{SD}$	√	
Power Supply Removal	$V_{IN} < 0.7V$	√	

**Table 2. Power Good Pin Logic Table (TLV62150A)**

Device State		PG Logic Status	
		High Impedance	Low
Enable (EN=High)	$V_{FB} \geq V_{TH\_PG}$	√	
	$V_{FB} \leq V_{TH\_PG}$		√
Shutdown (EN=Low)			√
UVLO	$0.7\text{ V} < V_{IN} < V_{UVLO}$		√
Thermal Shutdown	$T_J > T_{SD}$		√
Power Supply Removal	$V_{IN} < 0.7\text{ V}$	√	

### 8.3.4 Pin-Selectable Output Voltage (DEF)

The output voltage of the TLV62150 can be increased by 5% above the nominal voltage by setting the DEF pin to High <sup>(1)</sup>. When DEF is Low, the device regulates to the nominal output voltage. Increasing the nominal voltage allows adapting the power supply voltage to the variations of the application hardware. More detailed information on voltage margining using TLV62150 can be found in [SLVA489](#). A pull down resistor of about 400 kΩ is internally connected to the pin, to ensure a proper logic level if the pin is high impedance or floating after initially set to Low. The resistor is disconnected if the pin is set High.

### 8.3.5 Frequency Selection (FSW)

To get high power density with very small solution size, a high switching frequency allows the use of small external components for the output filter. However switching losses increase with the switching frequency. If efficiency is the key parameter, more than solution size, the switching frequency can be set to half (1.25 MHz typical) by pulling FSW to High. It is mandatory to start with FSW=Low to limit inrush current, which can be done by connecting to VOUT or PG. Running with lower frequency a higher efficiency, but also a higher output voltage ripple, is achieved. Pull FSW to Low for high frequency operation (2.5 MHz typical). To get low ripple and full output current at the lower switching frequency, it's recommended to use an inductor of at least 2.2 μH. The switching frequency can be changed during operation, if needed. A pull down resistor of about 400kOhm is internally connected to the pin, acting the same way as at the DEF Pin (see above).

### 8.3.6 Undervoltage Lockout (UVLO)

If the input voltage drops, the undervoltage lockout prevents misoperation of the device by switching off both the power FETs. The undervoltage lockout threshold is set typically to 2.7 V. The device is fully operational for voltages above the UVLO threshold and turns off if the input voltage trips the threshold. The converter starts operation again once the input voltage exceeds the threshold by a hysteresis of typically 200 mV.

### 8.3.7 Thermal Shutdown

The junction temperature ( $T_J$ ) of the device is monitored by an internal temperature sensor. If  $T_J$  exceeds 160°C (typical), the device goes into thermal shut down. Both the high-side and low-side power FETs are turned off and PG goes high impedance. When  $T_J$  decreases below the hysteresis amount, the converter resumes normal operation, beginning with Soft Start. To avoid unstable conditions, a hysteresis of typically 20°C is implemented on the thermal shut down temperature.

## 8.4 Device Functional Modes

### 8.4.1 Pulse Width Modulation (PWM) Operation

The TLV62150 operates with pulse width modulation in continuous conduction mode (CCM) with a nominal switching frequency of 2.5 MHz or 1.25 MHz, selectable with the FSW pin. The frequency variation in PWM is controlled and depends on  $V_{IN}$ ,  $V_{OUT}$  and the inductance. The device operates in PWM mode as long the output current is higher than half the inductor's ripple current. To maintain high efficiency at light loads, the device enters Power Save Mode at the boundary to discontinuous conduction mode (DCM). This happens if the output current becomes smaller than half the inductor's ripple current.

(1) Maximum allowed voltage is 7 V. Therefore, it's recommended to connect it to VOUT or PG, not VIN.

## Device Functional Modes (continued)

### 8.4.2 Power Save Mode Operation

The built in Power Save Mode of the TLV62150 is entered seamlessly, if the load current decreases. This secures a high efficiency in light load operation. The device remains in Power Save Mode as long as the inductor current is discontinuous.

In Power Save Mode the switching frequency decreases linearly with the load current maintaining high efficiency. The transition into and out of Power Save Mode happens within the entire regulation scheme and is seamless in both directions.

TLV62150 includes a fixed on-time circuitry. This on-time, in steady-state operation, can be estimated (for FSW=Low) as:

$$t_{ON} = \frac{V_{OUT}}{V_{IN}} \times 400 \text{ ns} \quad (1)$$

For very small output voltages, an absolute minimum on-time of about 80 ns is kept to limit switching losses. The operating frequency is thereby reduced from its nominal value, which keeps efficiency high. Also the off-time can reach its minimum value at high duty cycles. The output voltage remains regulated in such cases. Using  $t_{ON}$ , the typical peak inductor current in Power Save Mode can be approximated by:

$$I_{LPSM(peak)} = \frac{(V_{IN} - V_{OUT})}{L} \times t_{ON} \quad (2)$$

When  $V_{IN}$  decreases to typically 15% above  $V_{OUT}$ , the TLV62150 does not enter Power Save Mode, regardless of the load current. The device maintains output regulation in PWM mode.

### 8.4.3 100% Duty-Cycle Operation

The duty cycle of the buck converter is given by  $D=V_{out}/V_{in}$  and increases as the input voltage comes close to the output voltage. In this case, the device starts 100% duty cycle operation turning on the high-side switch 100% of the time. The high-side switch stays turned on as long as the output voltage is below the internal setpoint. This allows the conversion of small input to output voltage differences, for example, for longest operation time of battery-powered applications. In 100% duty cycle mode, the low-side FET is switched off.

The minimum input voltage to maintain output voltage regulation, depending on the load current and the output voltage level, can be calculated as:

$$V_{IN(min)} = V_{OUT(min)} + I_{OUT}(R_{DS(on)} + R_L) \quad (3)$$

where

- $I_{OUT}$  is the output current.
- $R_{DS(on)}$  is the  $R_{DS(on)}$  of the high-side FET.
- $R_L$  is the DC resistance of the inductor used.

### 8.4.4 Current Limit and Short Circuit Protection

The TLV62150 devices are protected against heavy load and short circuit events. At heavy loads, the current limit determines the maximum output current. If the current limit is reached, the high-side FET is turned off. Avoiding shoot through current, then the low-side FET switches on to allow the inductor current to decrease. The low-side current limit is typically 1.2 A. The high-side FET turns on again, only if the current in the low-side FET has decreased below the low side current limit threshold.

## Device Functional Modes (continued)

The output current of the device is limited by the current limit (see [Electrical Characteristics](#)). Due to internal propagation delay, the actual current can exceed the static current limit during that time. The dynamic current limit can be calculated as follows:

$$I_{\text{peak(typ)}} = I_{\text{LIMF}} + \frac{V_L}{L} \times t_{\text{PD}}$$

where

- $I_{\text{LIMF}}$  is the static current limit, specified in the [Electrical Characteristics](#).
- $L$  is the inductor value.
- $V_L$  is the voltage across the inductor ( $V_{\text{IN}} - V_{\text{OUT}}$ ).
- $t_{\text{PD}}$  is the internal propagation delay. (4)

The current limit can exceed static values, especially if the input voltage is high and very small inductances are used. The dynamic high side switch the peak current can be calculated as follows:

$$I_{\text{peak(typ)}} = I_{\text{LIMF}} + \frac{(V_{\text{IN}} - V_{\text{OUT}})}{L} \times 30\text{ns} \quad (5)$$

## 9 Application and Implementation

### NOTE

Information in the following applications sections is not part of the TI component specification, and TI does not warrant its accuracy or completeness. TI's customers are responsible for determining suitability of components for their purposes. Customers should validate and test their design implementation to confirm system functionality.

### 9.1 Application Information

The TLV62150 is a switched-mode step-down converter, able to convert a 4-V to 17-V input voltage into a 0.9-V to 5-V output voltage, providing up to 1 A. It needs a minimum amount of external components. Apart from the LC output filter and the input capacitor, the TLV62150 (TLV62150A) needs an additional resistive divider to set the output voltage level.

### 9.2 Typical Application

Figure 5 shows an application for Point-of-Load Power Supply Using TLV62150.

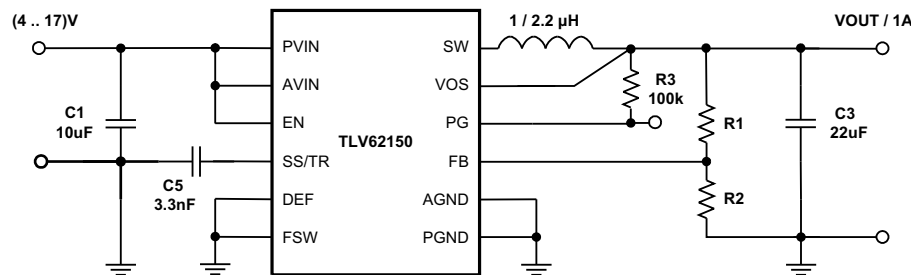

Figure 5. 1-A Step-Down Converter

#### 9.2.1 Design Requirements

The following design guideline provides a component selection to operate the device within the recommended operating conditions. Using the FSW pin, the design can be optimized for highest efficiency or smallest solution size and lowest output voltage ripple. For highest efficiency set FSW=High and the device operates at the lower switching frequency. For smallest solution size and lowest output voltage ripple set FSW=Low and the device operates with higher switching frequency. The typical values for all measurements are  $V_{IN} = 12\text{ V}$ ,  $V_{OUT} = 3.3\text{ V}$  and  $T = 25^\circ\text{C}$ , using the external components of Table 3.

#### 9.2.2 Detailed Design Procedure

The component selection used for measurements is given as follows:

Table 3. List of Components

REFERENCE	DESCRIPTION	MANUFACTURER <sup>(1)</sup>
IC	17-V, 1-A Step-Down Converter, VQFN	TLV62150RGT, Texas Instruments
L1	2.2 $\mu\text{H}$ , 0.165 x 0.165 in	XFL4020-222MEB, Coilcraft
C1	10 $\mu\text{F}$ , 25 V, Ceramic	Standard
C3	22 $\mu\text{F}$ , 6.3 V, Ceramic	Standard

(1) See [Third-Party Products](#) Disclaimer

## Typical Application (continued)

**Table 3. List of Components (continued)**

REFERENCE	DESCRIPTION	MANUFACTURER <sup>(1)</sup>
C5	3300 pF, 25 V, Ceramic	
R1	depending on Vout	
R2	depending on Vout	
R3	100 kΩ, Chip, 0603, 1/16 W, 1%	Standard

### 9.2.2.1 Programming the Output Voltage

The output voltage of the TLV62150 (TLV62150A) is adjustable. It can be programmed for output voltages from 0.9 V to 5 V by using a resistive divider from VOUT to AGND. The voltage at the FB pin is regulated to 800 mV. The value of the output voltage is set by the selection of the resistive divider from [Equation 6](#). It is recommended to choose resistor values which allow a current of at least 2 μA, meaning the value of R2 should not exceed 400 kΩ. Lower resistor values are recommended for highest accuracy and most robust design.

$$R_1 = R_2 \left( \frac{V_{OUT}}{0.8V} - 1 \right) \quad (6)$$

In case the FB pin gets opened, the device clamps the output voltage at the VOS pin internally to about 7.4 V.

### 9.2.2.2 External Component Selection

The external components have to fulfill the needs of the application, but also the stability criteria of the devices control loop. The TLV62150 is optimized to work within a range of external components. The LC output filter's inductance and capacitance have to be considered in conjunction, creating a double pole, responsible for the corner frequency of the converter (see [Output Filter and Loop Stability](#) section). [Table 4](#) can be used to simplify the output filter component selection. Checked cells represent combinations that are proven for stability by simulation and lab test. Further combinations should be checked for each individual application. See [SLVA463](#) for details.

**Table 4. L-C Output Filter Combinations<sup>(1)</sup>**

	4.7 μF	10 μF	22 μF	47 μF	100 μF	200 μF	400 μF
0.47 μH							
1 μH			√	√	√	√	
2.2 μH		√	√ <sup>(2)</sup>	√	√	√	
3.3 μH		√	√	√	√		
4.7 μH							

(1) The values in the table are nominal values. The effective capacitance was considered to vary by +20% and -50%.

(2) This LC combination is the standard value and recommended for most applications.

The TLV62150 can be run with an inductor as low as 1 μH or 2.2 μH. FSW should be set Low in this case. However, for applications running with the low frequency setting (FSW=High) or with low input voltages, 3.3 μH is recommended.

#### 9.2.2.2.1 Inductor Selection

The inductor selection is affected by several effects like inductor ripple current, output ripple voltage, PWM-to-PSM transition point and efficiency. In addition, the inductor selected has to be rated for appropriate saturation current and DC resistance (DCR). [Equation 7](#) and [Equation 8](#) calculate the maximum inductor current under static load conditions.

$$I_{L(max)} = I_{OUT(max)} + \frac{\Delta I_{L(max)}}{2} \quad (7)$$

$$\Delta I_{L(\max)} = V_{OUT} \times \left( \frac{1 - \frac{V_{OUT}}{V_{IN(\max)}}}{L_{(\min)} \times f_{SW}} \right)$$

where

- $I_L(\max)$  is the maximum inductor current.
- $\Delta I_L$  is the Peak to Peak Inductor Ripple Current.
- $L(\min)$  is the minimum effective inductor value.
- $f_{SW}$  is the actual PWM Switching Frequency. (8)

Calculating the maximum inductor current using the actual operating conditions gives the minimum saturation current of the inductor needed. A margin of about 20% is recommended to add. A larger inductor value is also useful to get lower ripple current, but increases the transient response time and size as well. The following inductors have been used with the TLV62150 and are recommended for use:

**Table 5. List of Inductors**

Type	Inductance [μH]	Saturation Current [A] <sup>(1)</sup>	Dimensions [L x B x H] mm	MANUFACTURER <sup>(2)</sup>
XFL4020-222ME_	2.2 μH, ±20%	3.5	4 x 4 x 2.1	Coilcraft
XFL3012-222MEC	2.2 μH, ±20%	1.6	3 x 3 x 1.2	Coilcraft
XFL3012-332MEC	3.3 μH, ±20%	1.4	3 x 3 x 1.2	Coilcraft
VLS252012T-2R2M1R3	2.2 μH, ±20%	1.3	2.5 x 2 x 1.2	TDK
LPS3015-332	3.3 μH, ±20%	1.4	3 x 3 x 1.4	Coilcraft
744025003	3.3 μH, ±20%	1.5	2.8 x 2.8 x 2.8	Wuerth
PSI25201B-2R2MS	2.2 μH, ±20%	1.3	2 x 2.5 x 1.2	Cyntec
NR3015T-2R2M	2.2 μH, ±20%	1.5	3 x 3 x 1.5	Taiyo Yuden

(1) Lower of  $I_{RMS}$  at 40°C rise or  $I_{SAT}$  at 30% drop.

(2) See [Third-Party Products](#) Disclaimer

The inductor value also determines the load current at which Power Save Mode is entered:

$$I_{load(PSM)} = \frac{1}{2} \Delta I_L$$
(9)

Using [Equation 8](#), this current level can be adjusted by changing the inductor value.

### 9.2.2.2.2 Capacitor Selection

#### 9.2.2.2.2.1 Output Capacitor

The recommended value for the output capacitor is 22 μF. The architecture of the TLV62150 allows the use of tiny ceramic output capacitors which have low equivalent series resistance (ESR). These capacitors provide low output voltage ripple and are recommended. To keep its low resistance up to high frequencies and to get narrow capacitance variation with temperature, it's recommended to use X7R or X5R dielectric. Using a higher value can have some advantages like smaller voltage ripple and a tighter DC output accuracy in Power Save Mode (see [SLVA463](#)).

Note: In power save mode, the output voltage ripple depends on the output capacitance, its ESR and the peak inductor current. Using ceramic capacitors provides small ESR and low ripple.

### 9.2.2.2.2 Input Capacitor

For most applications, 10  $\mu\text{F}$  will be sufficient and is recommended, though a larger value reduces input current ripple further. The input capacitor buffers the input voltage for transient events and also decouples the converter from the supply. A low ESR multilayer ceramic capacitor is recommended for best filtering and should be placed between PVIN and PGND as close as possible to those pins. Even though AVIN and PVIN must be supplied from the same input source, it's recommended to place a capacitance of 0.1  $\mu\text{F}$  from AVIN to AGND, to avoid potential noise coupling. An RC, low-pass filter from PVIN to AVIN may be used but is not required.

### 9.2.2.2.3 Soft-Start Capacitor

A capacitance connected between SS/TR pin and AGND allows a user programmable start-up slope of the output voltage. A constant current source supports 2.5  $\mu\text{A}$  to charge the external capacitance. The capacitor required for a given soft-start ramp time for the output voltage is given by:

$$C_{\text{SS}} = t_{\text{SS}} \times \frac{2.5\mu\text{A}}{1.25\text{V}} [\text{F}]$$

where

- $C_{\text{SS}}$  is the capacitance (F) required at the SS/TR pin.
  - $t_{\text{SS}}$  is the desired soft-start ramp time (s).
- (10)

#### NOTE

**DC Bias effect:** High capacitance ceramic capacitors have a DC Bias effect, which will have a strong influence on the final effective capacitance. Therefore the right capacitor value has to be chosen carefully. Package size and voltage rating in combination with dielectric material are responsible for differences between the rated capacitor value and the effective capacitance.

### 9.2.2.3 Tracking Function

If a tracking function is desired, the SS/TR pin can be used for this purpose by connecting it to an external tracking voltage. The output voltage tracks that voltage. If the tracking voltage is between 50 mV and 1.2 V, the FB pin will track the SS/TR pin voltage as described in [Equation 11](#) and shown in [Figure 6](#).

$$V_{\text{FB}} \approx 0.64 \times V_{\text{SS/TR}} \tag{11}$$

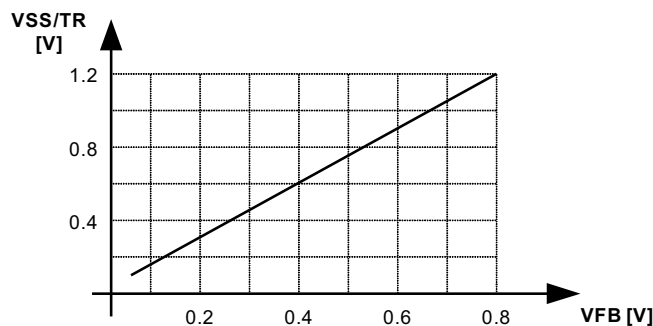
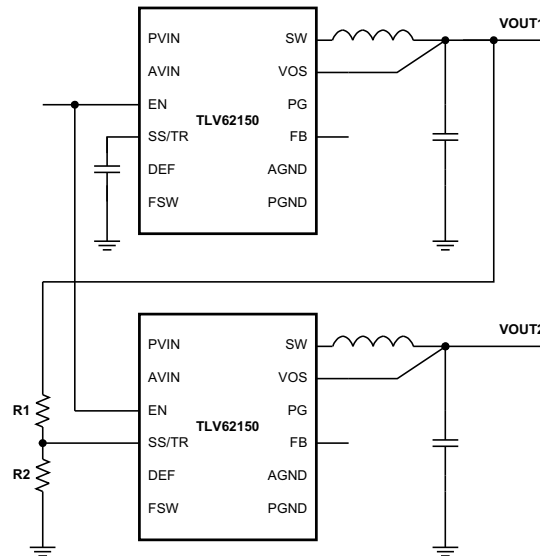

**Figure 6. Voltage Tracking Relationship**



Once the SS/TR pin voltage reaches about 1.2 V, the internal voltage is clamped to the internal feedback voltage and device goes to normal regulation. This works for rising and falling tracking voltages with the same behavior, as long as the input voltage is inside the recommended operating conditions. For decreasing SS/TR pin voltage, the device does not sink current from the output. So, the resulting decrease of the output voltage may be slower than the SS/TR pin voltage if the load is light. When driving the SS/TR pin with an external voltage, do not exceed the voltage rating of the SS/TR pin which is  $V_{IN}+0.3$  V.

If the input voltage drops into undervoltage lockout or even down to zero, the output voltage will go to zero, independent of the tracking voltage. [Figure 7](#) shows how to connect devices to get ratiometric and simultaneous sequencing by using the tracking function.



**Figure 7. Sequence for Ratiometric and Simultaneous Startup**

The resistive divider of R1 and R2 can be used to change the ramp rate of VOUT2 faster, slower or the same as VOUT1.

A sequential startup is achieved by connecting the PG pin of VOUT1 to the EN pin of VOUT2. Ratiometric start up sequence happens if both supplies are sharing the same soft start capacitor. [Equation 10](#) calculates the soft start time, though the SS/TR current has to be doubled. Details about these and other tracking and sequencing circuits are found in [SLVA470](#).

Note: If the voltage at the FB pin is below its typical value of 0.8 V, the output voltage accuracy may have a wider tolerance than specified.

#### 9.2.2.4 Output Filter and Loop Stability

The TLV62150 is internally compensated to be stable with L-C filter combinations corresponding to a corner frequency to be calculated with [Equation 12](#):

$$f_{LC} = \frac{1}{2\pi\sqrt{L \times C}} \tag{12}$$

Proven nominal values for inductance and ceramic capacitance are given in [Table 4](#) and are recommended for use. Different values may work, but care has to be taken on the loop stability which will be affected. More information including a detailed L-C stability matrix can be found in [SLVA463](#).

The TLV62150 includes an internal 25 pF feedforward capacitor, connected between the VOS and FB pins. This capacitor impacts the frequency behavior and sets a pole and zero in the control loop with the resistors of the feedback divider, per equation [Equation 13](#) and [Equation 14](#):

$$f_{\text{zero}} = \frac{1}{2\pi \times R_1 \times 25\text{pF}} \quad (13)$$

$$f_{\text{pole}} = \frac{1}{2\pi \times 25\text{pF}} \times \left( \frac{1}{R_1} + \frac{1}{R_2} \right) \quad (14)$$

Though the TLV62150 is stable without the pole and zero being in a particular location, adjusting their location to the specific needs of the application can provide better performance in Power Save mode and/or improved transient response. An external feedforward capacitor can also be added. A more detailed discussion on the optimization for stability versus transient response can be found in [SLVA289](#) and [SLVA466](#).

### 9.2.3 Application Curves

$V_{IN} = 12\text{ V}$ ,  $V_{OUT} = 3.3\text{ V}$ ,  $T_A = 25^\circ\text{C}$ , (unless otherwise noted)

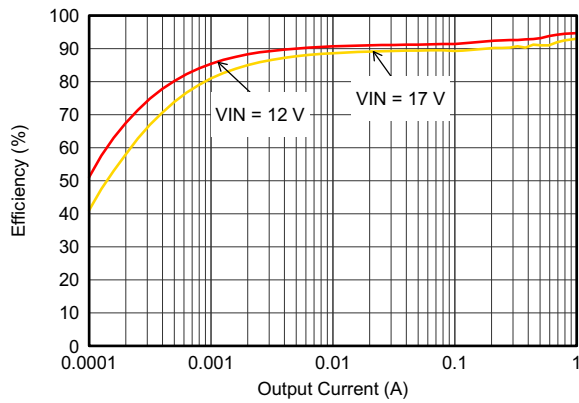

Figure 8. Efficiency With 1.25 MHz,  $V_{out} = 5\text{ V}$

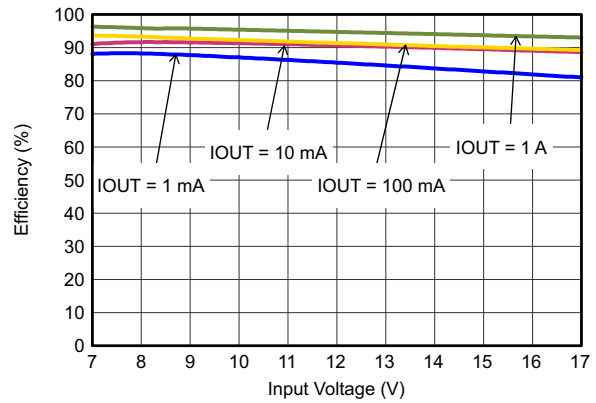

Figure 9. Efficiency With 1.25 MHz,  $V_{out} = 5\text{ V}$

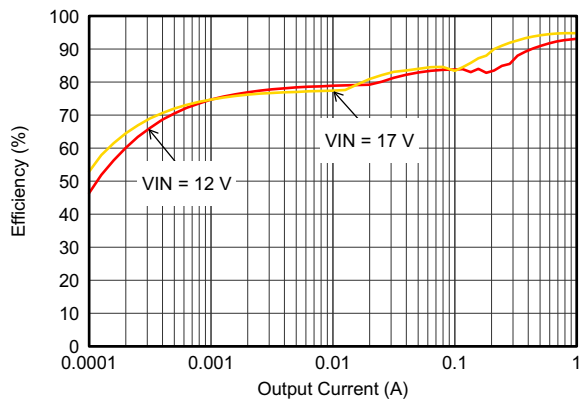

Figure 10. Efficiency With 2.5 MHz,  $V_{out} = 5\text{ V}$

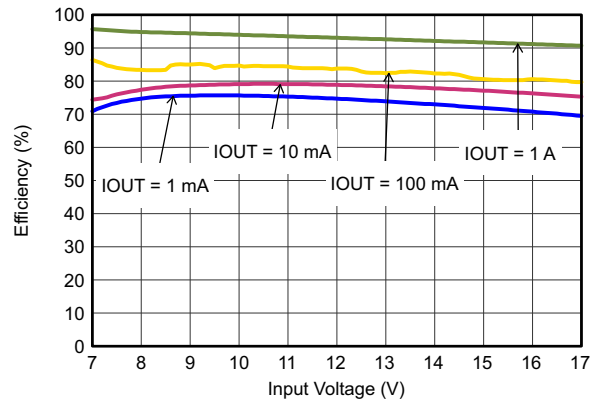

Figure 11. Efficiency With 2.5 MHz,  $V_{out} = 5\text{ V}$

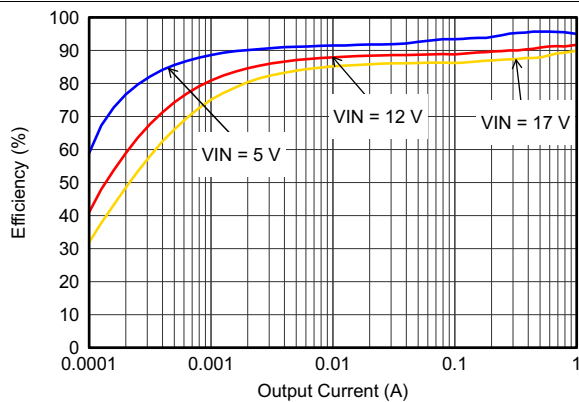

Figure 12. Efficiency With 1.25 MHz,  $V_{out} = 3.3\text{ V}$

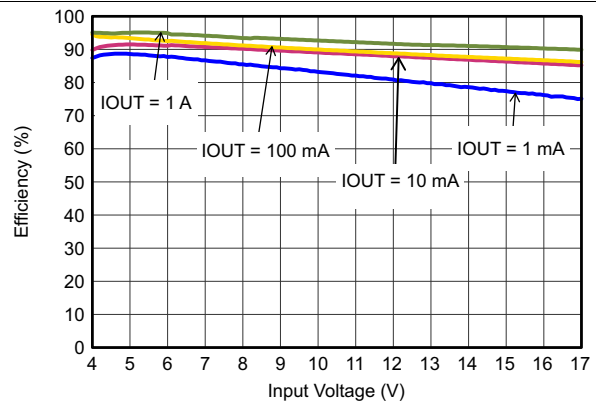

Figure 13. Efficiency With 1.25 MHz,  $V_{out} = 3.3\text{ V}$

TLV62150, TLV62150A

SLVSB71E – FEBRUARY 2012 – REVISED SEPTEMBER 2016

www.ti.com

$V_{IN} = 12\text{ V}$ ,  $V_{OUT} = 3.3\text{ V}$ ,  $T_A = 25^\circ\text{C}$ , (unless otherwise noted)

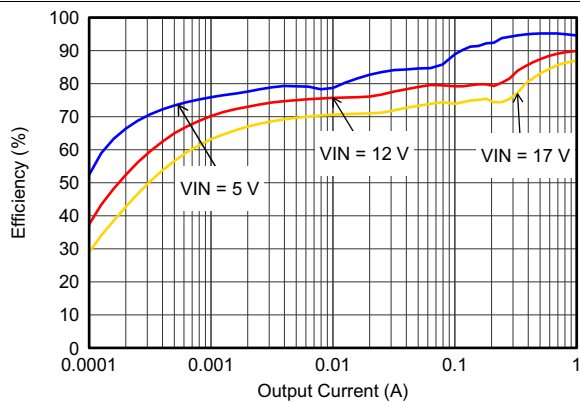

Figure 14. Efficiency With 2.5 MHz,  $V_{out} = 3.3\text{ V}$

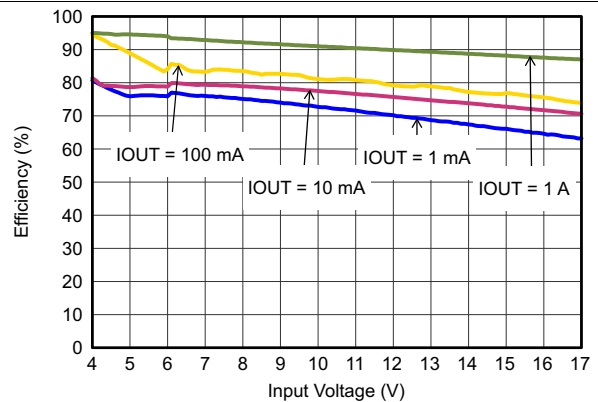

Figure 15. Efficiency With 2.5 MHz,  $V_{out} = 3.3\text{ V}$

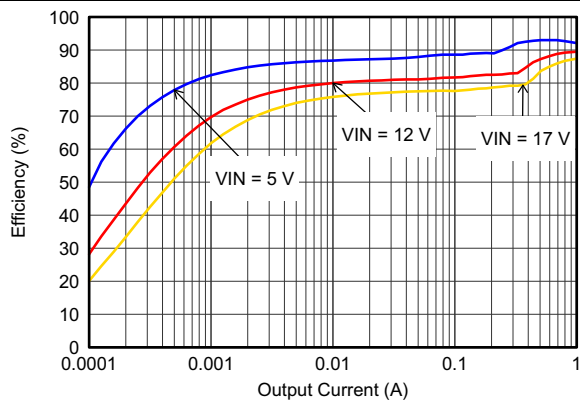

Figure 16. Efficiency With 1.25 MHz,  $V_{out} = 1.8\text{ V}$

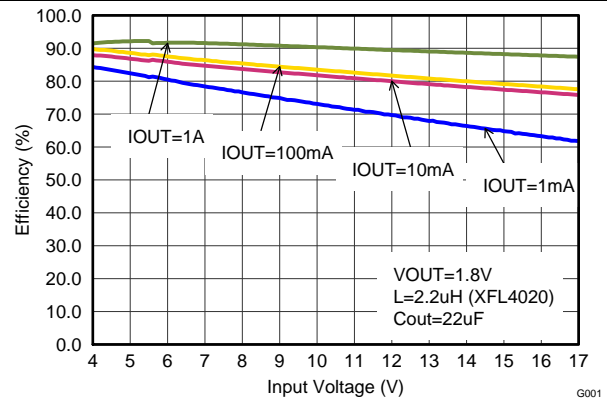

Figure 17. Efficiency With 1.25 MHz,  $V_{out} = 1.8\text{ V}$

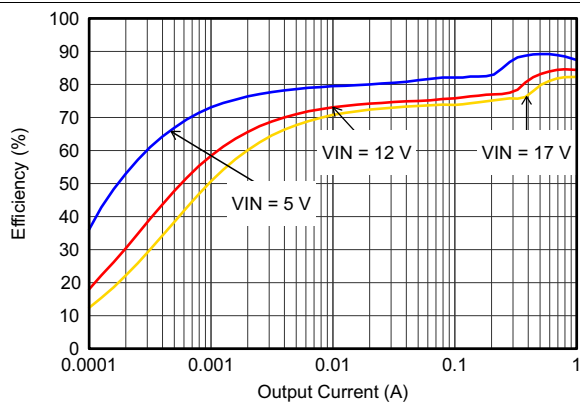

Figure 18. Efficiency With 1.25 MHz,  $V_{out} = 0.9\text{ V}$

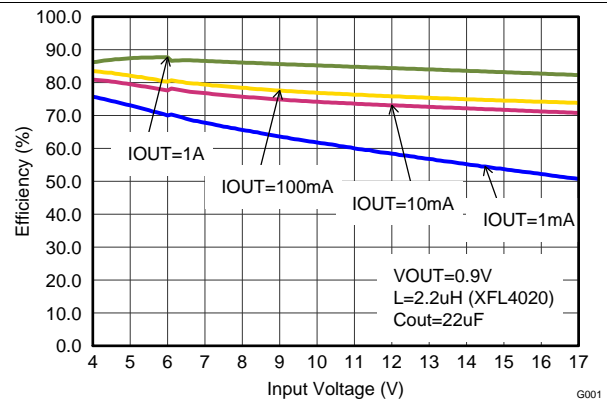

Figure 19. Efficiency With 1.25 MHz,  $V_{out}=0.9\text{ V}$

$V_{IN} = 12\text{ V}$ ,  $V_{OUT} = 3.3\text{ V}$ ,  $T_A = 25^\circ\text{C}$ , (unless otherwise noted)

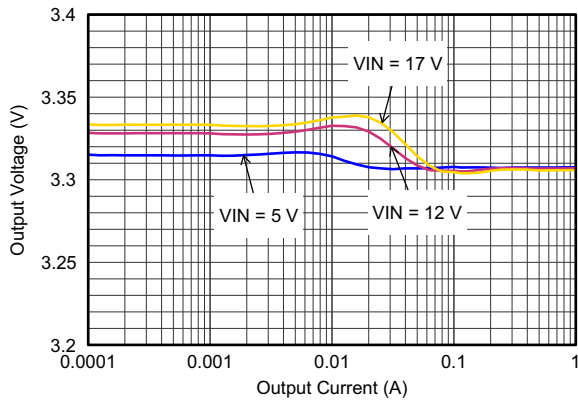

Figure 20. Output Voltage Accuracy (Load Regulation)

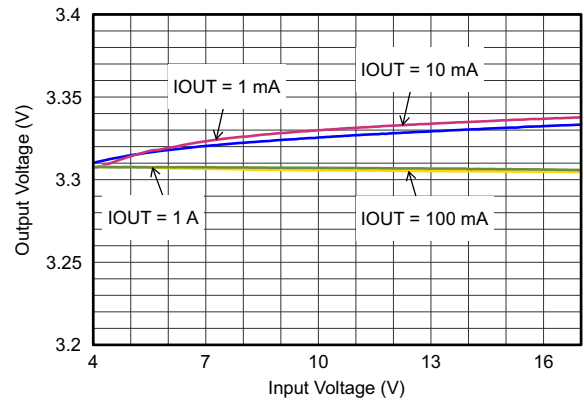

Figure 21. Output Voltage Accuracy (Line Regulation)

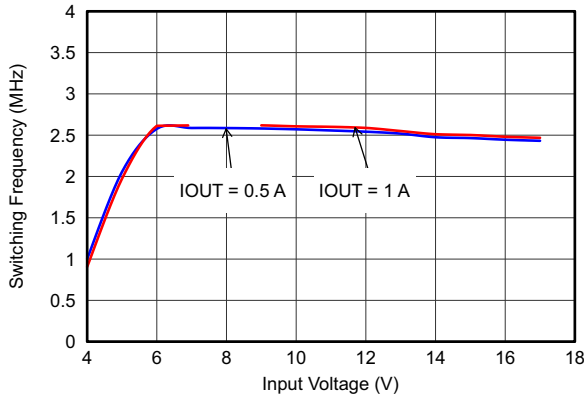

Figure 22. Switching Frequency

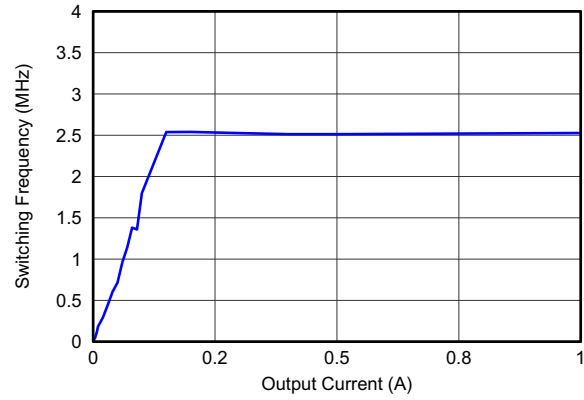

Figure 23. Switching Frequency

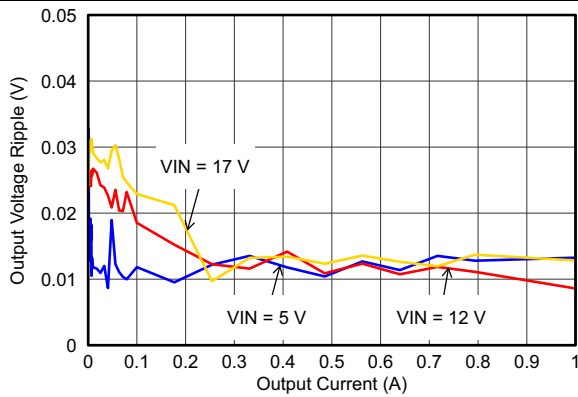

Figure 24. Output Voltage Ripple

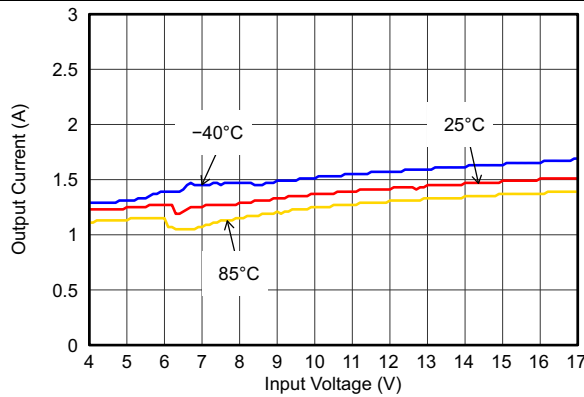

Figure 25. Maximum Output Current

TLV62150, TLV62150A

SLVSB71E – FEBRUARY 2012 – REVISED SEPTEMBER 2016

www.ti.com

$V_{IN} = 12\text{ V}$ ,  $V_{OUT} = 3.3\text{ V}$ ,  $T_A = 25^\circ\text{C}$ , (unless otherwise noted)

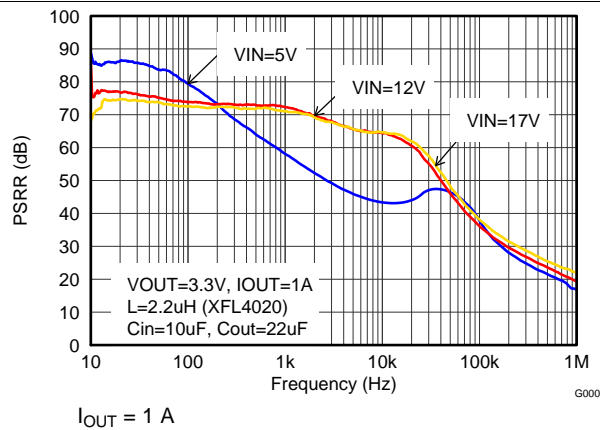

Figure 26. Power Supply Rejection Ratio,  $F_{SW} = 2.5\text{ MHz}$

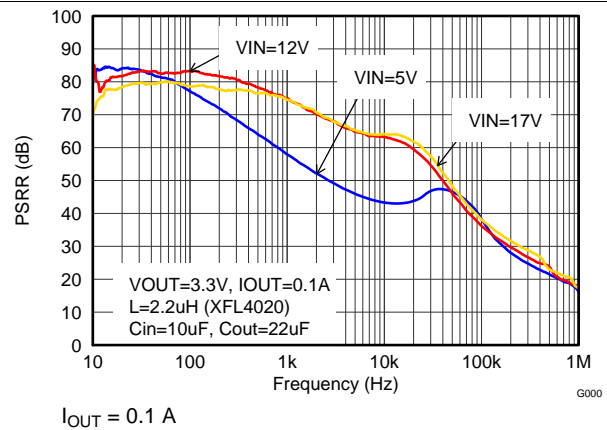

Figure 27. Power Supply Rejection Ratio,  $F_{SW} = 2.5\text{ MHz}$

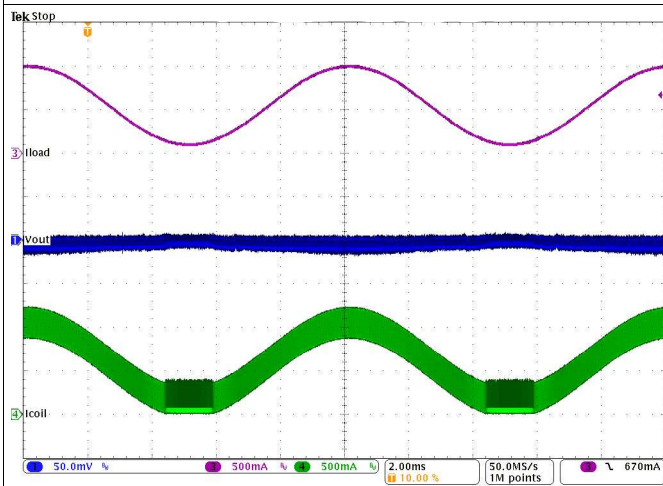

Figure 28. PWM-PSM-Transition  
( $V_{IN} = 12\text{ V}$ ,  $V_{OUT} = 3.3\text{ V}$  With 50 mV/div)

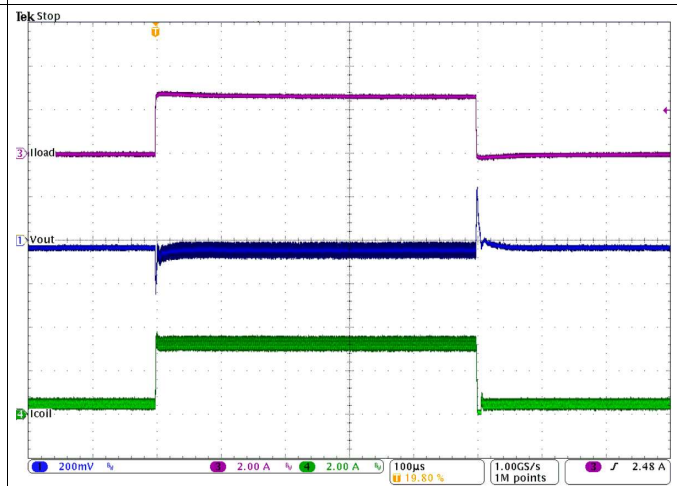

Figure 29. Load Transient Response  
( $I_{OUT} = 0.5\text{ to }1\text{ to }0.5\text{ A}$ ,  $V_{IN} = 12\text{ V}$ ,  $V_{OUT} = 3.3\text{ V}$ )

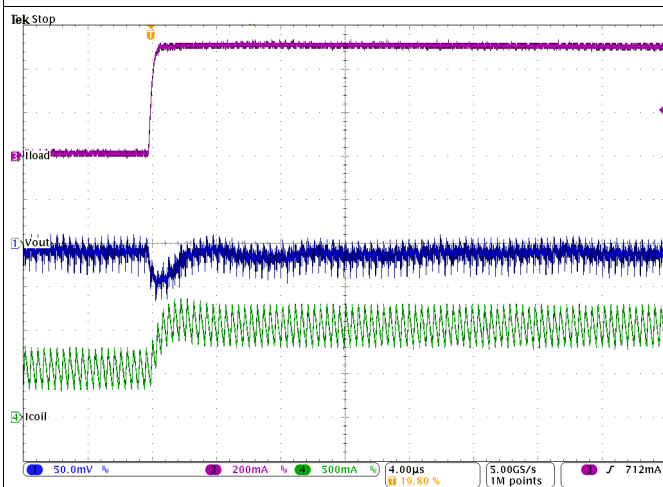

Figure 30. Load Transient Response of Figure 29,  
Rising Edge

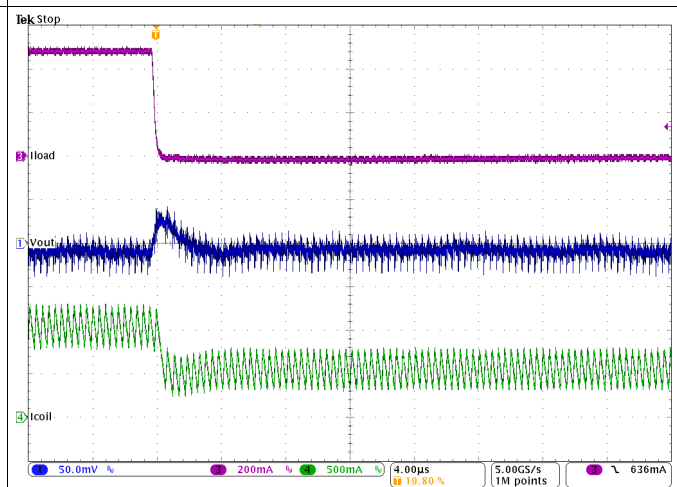

Figure 31. Load Transient Response of Figure 29,  
Falling Edge

$V_{IN} = 12\text{ V}$ ,  $V_{OUT} = 3.3\text{ V}$ ,  $T_A = 25^\circ\text{C}$ , (unless otherwise noted)

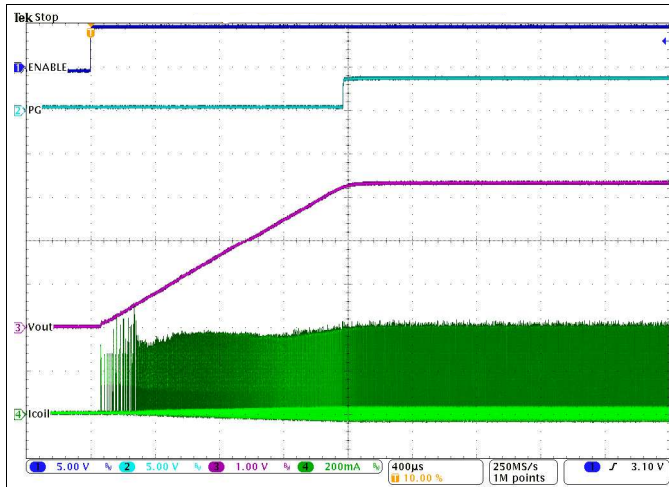

Figure 32. Startup Into 100 mA

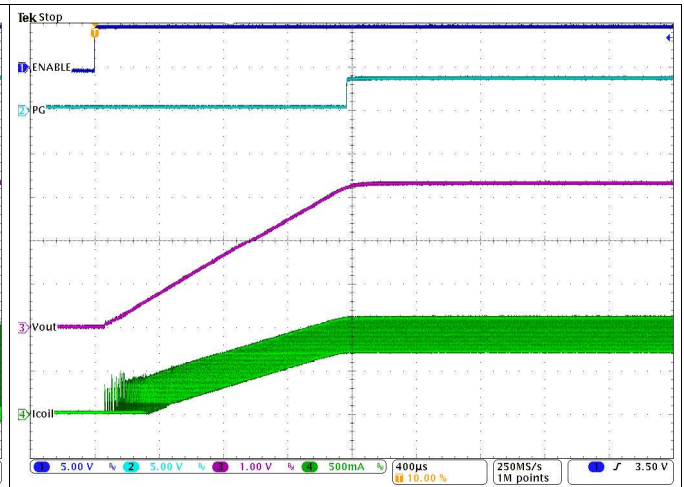

Figure 33. Startup Into 1 A

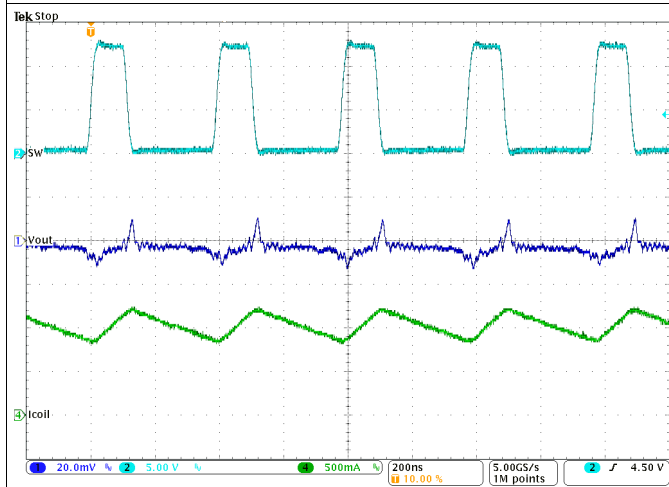

Figure 34. Typical Operation In PWM Mode  
( $I_{OUT} = 1\text{ A}$ )

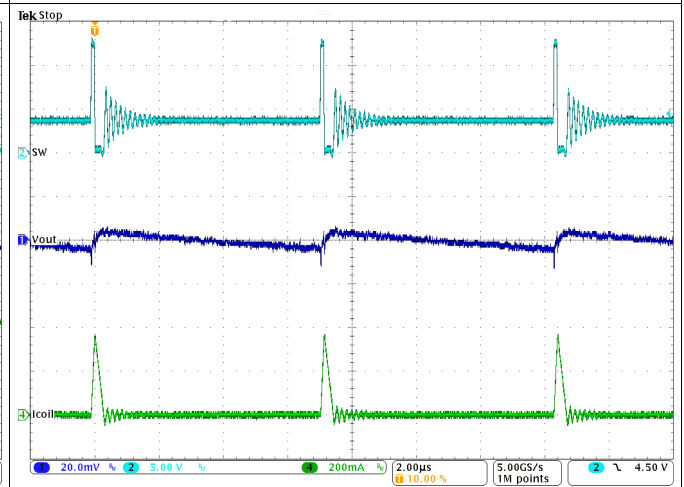

Figure 35. Typical Operation in Power Save Mode  
( $I_{OUT} = 10\text{ mA}$ )

## 9.3 System Examples

### 9.3.1 LED Power Supply

The TLV62150x can be used as a power supply for power LEDs. The FB pin can be easily set down to lower values than nominal by using the SS/TR pin. With that, the voltage drop on the sense resistor is low to avoid excessive power loss. Since this pin provides  $2.5\ \mu\text{A}$ , the FB pin voltage can be adjusted by an external resistor per Equation 15. This drop, proportional to the LED current, is used to regulate the output voltage (anode voltage) to a proper level to drive the LED. Both analog and PWM dimming are supported with the TLV62150. Figure 36 shows an application circuit, tested with analog dimming:

## System Examples (continued)

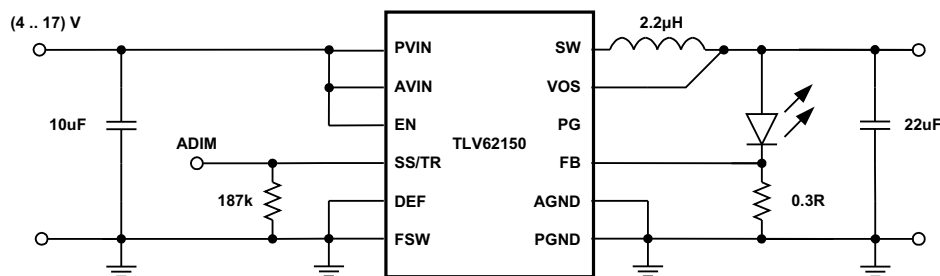

**Figure 36. 1-A Single LED Power Supply**

The resistor at SS/TR sets the FB voltage to a level of about 300 mV and is calculated from [Equation 15](#).

$$V_{FB} = 0.64 \times 2.5\mu\text{A} \times R_{SS/TR} \quad (15)$$

The device now supplies a constant current, set by the resistor at the FB pin, by regulating the output voltage accordingly. The minimum input voltage has to be rated according to the forward voltage needed by the LED used. More information is available in the Application Note [SLVA451](#).

### 9.3.2 Active Output Discharge

The TLV62150A pulls the PG pin Low, when the device is shut down by EN, UVLO or thermal shutdown. Connecting PG to Vout through a resistor can be used to discharge Vout in those cases (see [Figure 37](#)). The discharge rate can be adjusted by R3, which is also used to pull up the PG pin in normal operation. For reliability, keep the maximum current into the PG pin less than 10 mA.

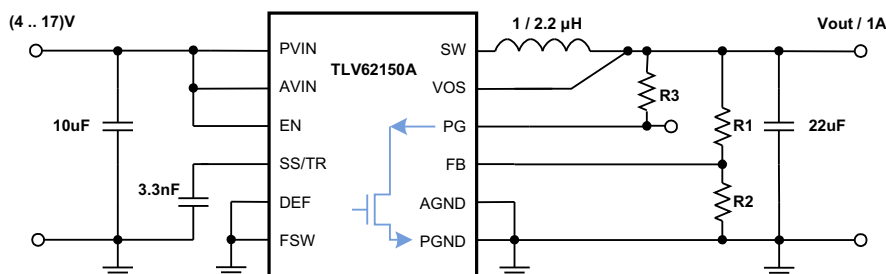

**Figure 37. Discharge Vout Through PG Pin with TLV62150A**

### 9.3.3 Inverting Power Supply

The TLV62150 can be used as inverting power supply by rearranging external circuitry as shown in [Figure 38](#). As the former GND node now represents a voltage level below system ground, the voltage difference between VIN and VOUT has to be limited for operation to the maximum supply voltage of 17 V (see [Equation 16](#)).

$$V_{IN} + |V_{OUT}| \leq V_{INmax} \quad (16)$$



System Examples (continued)

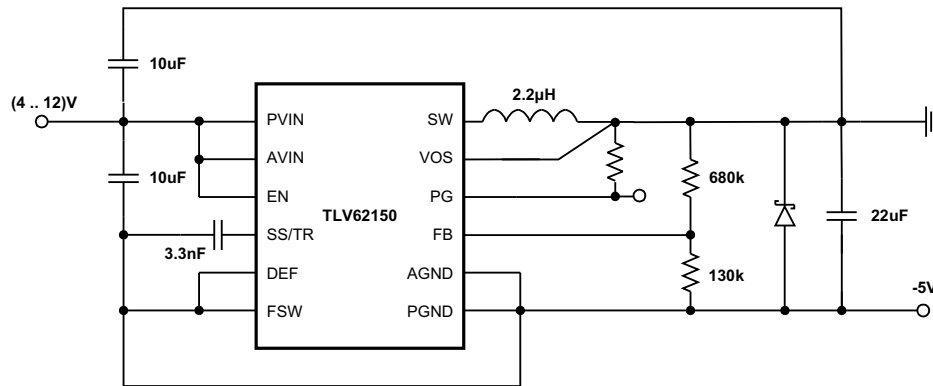

Figure 38. -5-V Inverting Power Supply

The transfer function of the inverting power supply configuration differs from the buck mode transfer function, incorporating a Right Half Plane Zero additionally. The loop stability has to be adapted and an output capacitance of at least 22 µF is recommended. A detailed design example is given in [SLVA469](#).

9.3.4 Various Output Voltages

The following example circuits show how to configure the external circuitry to furnish different output voltages at 1 A.

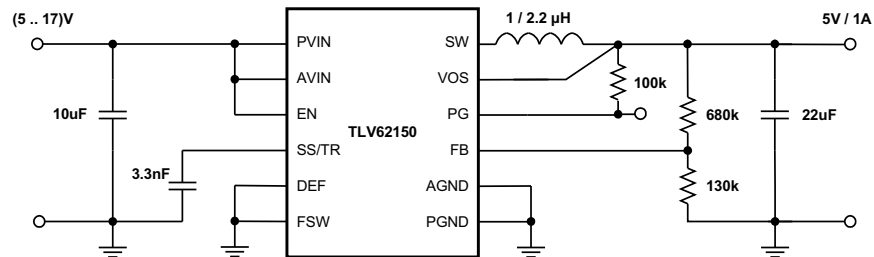

Figure 39. 5-V/1-A Power Supply

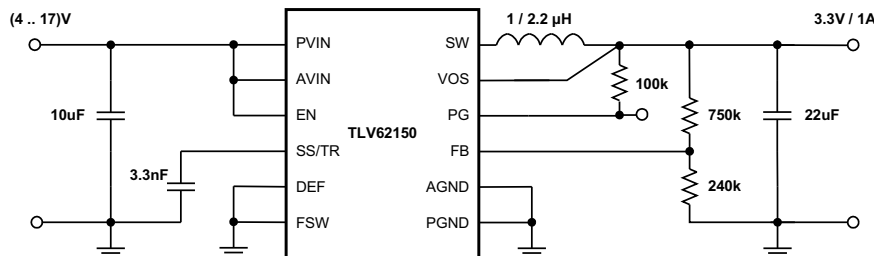
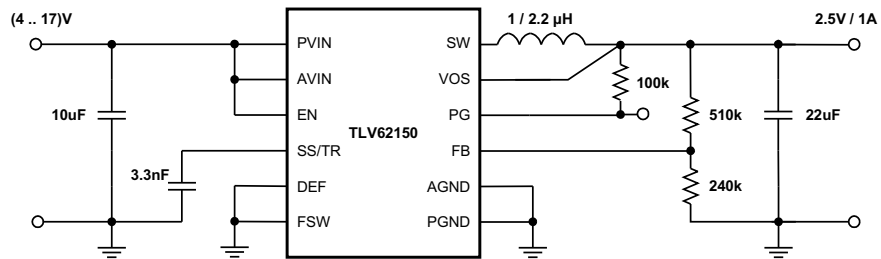
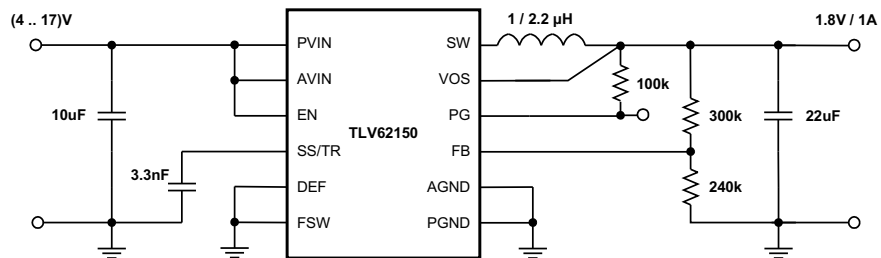
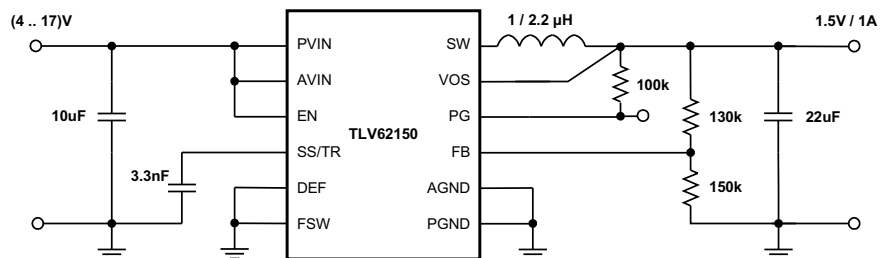
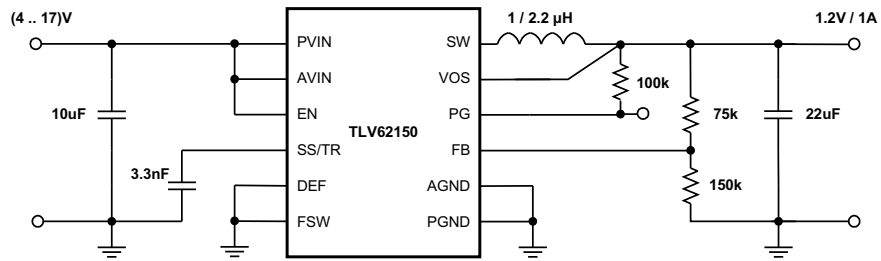

Figure 40. 3.3-V/1-A Power Supply

**System Examples (continued)**

**Figure 41. 2.5-V/1-A Power Supply**

**Figure 42. 1.8-V/1-A Power Supply**

**Figure 43. 1.5-V/1-A Power Supply**

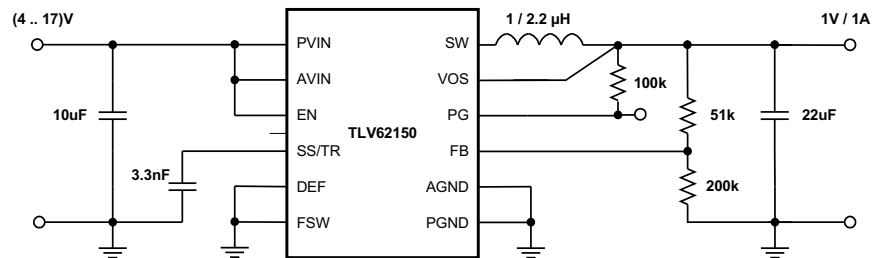
**System Examples (continued)**



**Figure 44. 1.2-V/1-A Power Supply**



**Figure 45. 1-V/1-A Power Supply**

**10 Power Supply Recommendations**

The TLV6215X are designed to operate from a 4-V to 17-V input voltage supply. The input power supply's output current needs to be rated according to the output voltage and the output current of the power rail application.

## 11 Layout

### 11.1 Layout Guidelines

A proper layout is critical for the operation of a switched mode power supply, even more at high switching frequencies. Therefore the PCB layout of the TLV62150 demands careful attention to ensure operation and to get the performance specified. A poor layout can lead to issues like poor regulation (both line and load), stability and accuracy weaknesses, increased EMI radiation and noise sensitivity.

See [Figure 46](#) for the recommended layout of the TLV62150, which is designed for common external ground connections. Therefore both AGND and PGND pins are directly connected to the Exposed Thermal Pad. On the PCB, the direct common ground connection of AGND and PGND to the Exposed Thermal Pad and the system ground (ground plane) is mandatory. Also connect the VOS pin in the shortest way to VOUT at the output capacitor. To avoid noise coupling into the VOS line, this connection should be separated from the VOUT power line/plane as shown in [Layout Example](#).

Provide low inductive and resistive paths for loops with high di/dt. Therefore paths conducting the switched load current should be as short and wide as possible. Provide low capacitive paths (with respect to all other nodes) for wires with high dv/dt. Therefore the input and output capacitance should be placed as close as possible to the IC pins and parallel wiring over long distances as well as narrow traces should be avoided. Loops which conduct an alternating current should outline an area as small as possible, as this area is proportional to the energy radiated.

Sensitive nodes like FB and VOS need to be connected with short wires and not nearby high dv/dt signals (e.g. SW). As they carry information about the output voltage, they should be connected as close as possible to the actual output voltage (at the output capacitor). The capacitor on the SS/TR pin and on AVIN as well as the FB resistors, R1 and R2, should be kept close to the IC and connect directly to those pins and the system ground plane.

The Exposed Thermal Pad must be soldered to the circuit board for mechanical reliability and to achieve appropriate power dissipation.

The recommended layout is implemented on the EVM and shown in its Users Guide, [SLAU416](#). Additionally, the EVM Gerber data are available for download here, [SLVC394](#).

### 11.2 Layout Example

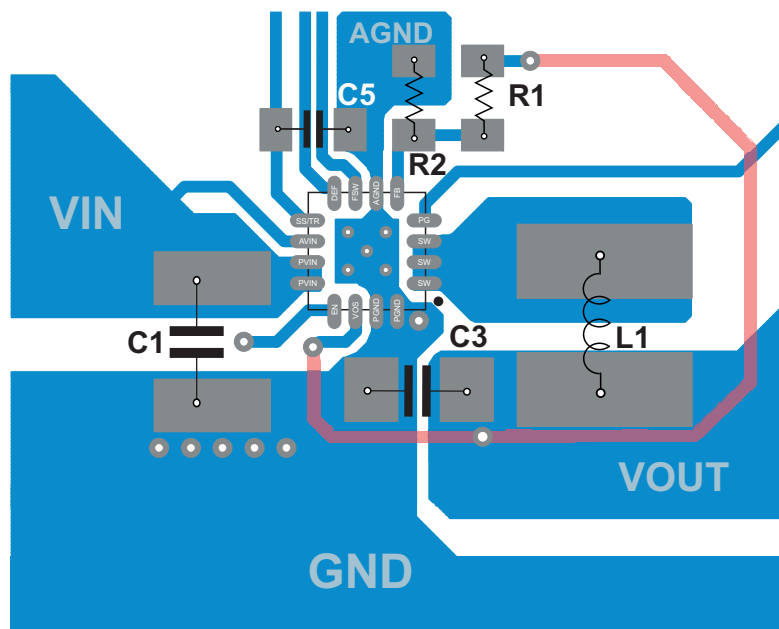

Figure 46. Layout Example Recommendation

### 11.3 Thermal Considerations

Implementation of integrated circuits in low-profile and fine-pitch surface-mount packages typically requires special attention to power dissipation. Many system-dependent issues such as thermal coupling, airflow, added heat sinks and convection surfaces, and the presence of other heat-generating components affect the power-dissipation limits of a given component.

Three basic approaches for enhancing thermal performance are listed below:

- Improving the power dissipation capability of the PCB design
- Improving the thermal coupling of the component to the PCB by soldering the Exposed Thermal Pad
- Introducing airflow in the system

For more details on how to use the thermal parameters, see the application notes: thermal characteristics application note ([SZZA017](#)), and ([SPRA953](#)).

The TLV62150 is designed for a maximum operating junction temperature ( $T_j$ ) of 125°C. Therefore the maximum output power is limited by the power losses that can be dissipated over the actual thermal resistance, given by the package and the surrounding PCB structures. Since the thermal resistance of the package is fixed, increasing the size of the surrounding copper area and improving the thermal connection to the IC can reduce the thermal resistance. To get an improved thermal behavior, it's recommended to use top layer metal to connect the device with wide and thick metal lines. Internal ground layers can connect to vias directly under the IC for improved thermal performance.

If short circuit or overload conditions are present, the device is protected by limiting internal power dissipation.

## 12 Device and Documentation Support

### 12.1 Device Support

#### 12.1.1 Third-Party Products Disclaimer

TI'S PUBLICATION OF INFORMATION REGARDING THIRD-PARTY PRODUCTS OR SERVICES DOES NOT CONSTITUTE AN ENDORSEMENT REGARDING THE SUITABILITY OF SUCH PRODUCTS OR SERVICES OR A WARRANTY, REPRESENTATION OR ENDORSEMENT OF SUCH PRODUCTS OR SERVICES, EITHER ALONE OR IN COMBINATION WITH ANY TI PRODUCT OR SERVICE.

### 12.2 Related Links

The table below lists quick access links. Categories include technical documents, support and community resources, tools and software, and quick access to sample or buy.

**Table 6. Related Links**

PARTS	PRODUCT FOLDER	SAMPLE & BUY	TECHNICAL DOCUMENTS	TOOLS & SOFTWARE	SUPPORT & COMMUNITY
TLV62150	<a href="#">Click here</a>	<a href="#">Click here</a>	<a href="#">Click here</a>	<a href="#">Click here</a>	<a href="#">Click here</a>
TLV62150A	<a href="#">Click here</a>	<a href="#">Click here</a>	<a href="#">Click here</a>	<a href="#">Click here</a>	<a href="#">Click here</a>

### 12.3 Documentation Support

#### 12.3.1 Related Documentation

For related documentation, see the following:

- *TLV62130EVM-505 and TLV62150EVM-505 Evaluation Modules*, [SLAU416](#)
- EVM Gerber data, [SLVC394](#)
- *Thermal Characteristics of Linear and Logic Packages Using JEDEC PCB Designs*, [SZZA017](#)
- *Semiconductor and IC Package Thermal Metrics*, [SPRA953](#)

### 12.4 Receiving Notification of Documentation Updates

To receive notification of documentation updates, navigate to the device product folder on ti.com. In the upper right corner, click on *Alert me* to register and receive a weekly digest of any product information that has changed. For change details, review the revision history included in any revised document.

### 12.5 Community Resources

The following links connect to TI community resources. Linked contents are provided "AS IS" by the respective contributors. They do not constitute TI specifications and do not necessarily reflect TI's views; see TI's [Terms of Use](#).

**TI E2E™ Online Community** *TI's Engineer-to-Engineer (E2E) Community*. Created to foster collaboration among engineers. At [e2e.ti.com](http://e2e.ti.com), you can ask questions, share knowledge, explore ideas and help solve problems with fellow engineers.

**Design Support** *TI's Design Support* Quickly find helpful E2E forums along with design support tools and contact information for technical support.

### 12.6 Trademarks

DCS-Control, E2E are trademarks of Texas Instruments.  
All other trademarks are the property of their respective owners.

### 12.7 Electrostatic Discharge Caution



These devices have limited built-in ESD protection. The leads should be shorted together or the device placed in conductive foam during storage or handling to prevent electrostatic damage to the MOS gates.

## 12.8 Glossary

[SLYZ022](#) — *TI Glossary*.

This glossary lists and explains terms, acronyms, and definitions.

## 13 Mechanical, Packaging, and Orderable Information

The following pages include mechanical, packaging, and orderable information. This information is the most current data available for the designated devices. This data is subject to change without notice and revision of this document. For browser-based versions of this data sheet, refer to the left-hand navigation.

**PACKAGING INFORMATION**

Orderable part number	Status (1)	Material type (2)	Package   Pins	Package qty   Carrier	RoHS (3)	Lead finish/ Ball material (4)	MSL rating/ Peak reflow (5)	Op temp (°C)	Part marking (6)
<a href="#">TLV62150ARGTR</a>	Active	Production	VQFN (RGT)   16	3000   LARGE T&R	Yes	NIPDAU	Level-1-260C-UNLIM	-40 to 85	VUOI
TLV62150ARGTR.A	Active	Production	VQFN (RGT)   16	3000   LARGE T&R	Yes	NIPDAU	Level-1-260C-UNLIM	-40 to 85	VUOI
TLV62150ARGTR.B	Active	Production	VQFN (RGT)   16	3000   LARGE T&R	Yes	NIPDAU	Level-1-260C-UNLIM	-40 to 85	VUOI
TLV62150ARGTRG4	Active	Production	VQFN (RGT)   16	3000   LARGE T&R	Yes	NIPDAU	Level-1-260C-UNLIM	-40 to 85	VUOI
TLV62150ARGTRG4.A	Active	Production	VQFN (RGT)   16	3000   LARGE T&R	Yes	NIPDAU	Level-1-260C-UNLIM	-40 to 85	VUOI
TLV62150ARGTRG4.B	Active	Production	VQFN (RGT)   16	3000   LARGE T&R	Yes	NIPDAU	Level-1-260C-UNLIM	-40 to 85	VUOI
<a href="#">TLV62150ARGTT</a>	Active	Production	VQFN (RGT)   16	250   SMALL T&R	Yes	NIPDAU	Level-2-260C-1 YEAR	-40 to 85	VUOI
TLV62150ARGTT.A	Active	Production	VQFN (RGT)   16	250   SMALL T&R	Yes	NIPDAU	Level-2-260C-1 YEAR	-40 to 85	VUOI
TLV62150ARGTT.B	Active	Production	VQFN (RGT)   16	250   SMALL T&R	Yes	NIPDAU	Level-2-260C-1 YEAR	-40 to 85	VUOI
<a href="#">TLV62150RGTR</a>	Active	Production	VQFN (RGT)   16	3000   LARGE T&R	Yes	NIPDAU	Level-1-260C-UNLIM	-40 to 85	VUCI
TLV62150RGTR.A	Active	Production	VQFN (RGT)   16	3000   LARGE T&R	Yes	NIPDAU	Level-1-260C-UNLIM	-40 to 85	VUCI
TLV62150RGTR.B	Active	Production	VQFN (RGT)   16	3000   LARGE T&R	Yes	NIPDAU	Level-1-260C-UNLIM	-40 to 85	VUCI
TLV62150RGTRG4	Active	Production	VQFN (RGT)   16	3000   LARGE T&R	Yes	NIPDAU	Level-2-260C-1 YEAR	-40 to 85	VUCI
TLV62150RGTRG4.A	Active	Production	VQFN (RGT)   16	3000   LARGE T&R	Yes	NIPDAU	Level-2-260C-1 YEAR	-40 to 85	VUCI
TLV62150RGTRG4.B	Active	Production	VQFN (RGT)   16	3000   LARGE T&R	Yes	NIPDAU	Level-2-260C-1 YEAR	-40 to 85	VUCI
<a href="#">TLV62150RGTT</a>	Active	Production	VQFN (RGT)   16	250   SMALL T&R	Yes	NIPDAU	Level-1-260C-UNLIM	-40 to 85	VUCI
TLV62150RGTT.A	Active	Production	VQFN (RGT)   16	250   SMALL T&R	Yes	NIPDAU	Level-1-260C-UNLIM	-40 to 85	VUCI
TLV62150RGTT.B	Active	Production	VQFN (RGT)   16	250   SMALL T&R	Yes	NIPDAU	Level-1-260C-UNLIM	-40 to 85	VUCI

(1) **Status:** For more details on status, see our [product life cycle](#).

(2) **Material type:** When designated, preproduction parts are prototypes/experimental devices, and are not yet approved or released for full production. Testing and final process, including without limitation quality assurance, reliability performance testing, and/or process qualification, may not yet be complete, and this item is subject to further changes or possible discontinuation. If available for ordering, purchases will be subject to an additional waiver at checkout, and are intended for early internal evaluation purposes only. These items are sold without warranties of any kind.

(3) **RoHS values:** Yes, No, RoHS Exempt. See the [TI RoHS Statement](#) for additional information and value definition.

(4) **Lead finish/Ball material:** Parts may have multiple material finish options. Finish options are separated by a vertical ruled line. Lead finish/Ball material values may wrap to two lines if the finish value exceeds the maximum column width.



(5) **MSL rating/Peak reflow:** The moisture sensitivity level ratings and peak solder (reflow) temperatures. In the event that a part has multiple moisture sensitivity ratings, only the lowest level per JEDEC standards is shown. Refer to the shipping label for the actual reflow temperature that will be used to mount the part to the printed circuit board.

(6) **Part marking:** There may be an additional marking, which relates to the logo, the lot trace code information, or the environmental category of the part.

Multiple part markings will be inside parentheses. Only one part marking contained in parentheses and separated by a "~" will appear on a part. If a line is indented then it is a continuation of the previous line and the two combined represent the entire part marking for that device.

**Important Information and Disclaimer:**The information provided on this page represents TI's knowledge and belief as of the date that it is provided. TI bases its knowledge and belief on information provided by third parties, and makes no representation or warranty as to the accuracy of such information. Efforts are underway to better integrate information from third parties. TI has taken and continues to take reasonable steps to provide representative and accurate information but may not have conducted destructive testing or chemical analysis on incoming materials and chemicals. TI and TI suppliers consider certain information to be proprietary, and thus CAS numbers and other limited information may not be available for release.

In no event shall TI's liability arising out of such information exceed the total purchase price of the TI part(s) at issue in this document sold by TI to Customer on an annual basis.

**TAPE AND REEL INFORMATION**

**QUADRANT ASSIGNMENTS FOR PIN 1 ORIENTATION IN TAPE**

\*All dimensions are nominal

Device	Package Type	Package Drawing	Pins	SPQ	Reel Diameter (mm)	Reel Width W1 (mm)	A0 (mm)	B0 (mm)	K0 (mm)	P1 (mm)	W (mm)	Pin1 Quadrant
TLV62150ARGTR	VQFN	RGT	16	3000	330.0	12.4	3.3	3.3	1.1	8.0	12.0	Q2
TLV62150ARGTRG4	VQFN	RGT	16	3000	330.0	12.4	3.3	3.3	1.1	8.0	12.0	Q2
TLV62150ARGTT	VQFN	RGT	16	250	180.0	12.4	3.3	3.3	1.1	8.0	12.0	Q2
TLV62150RGTR	VQFN	RGT	16	3000	330.0	12.4	3.3	3.3	1.1	8.0	12.0	Q2
TLV62150RGTRG4	VQFN	RGT	16	3000	330.0	12.4	3.3	3.3	1.1	8.0	12.0	Q2
TLV62150RGTT	VQFN	RGT	16	250	180.0	12.4	3.3	3.3	1.1	8.0	12.0	Q2

**TAPE AND REEL BOX DIMENSIONS**

\*All dimensions are nominal

Device	Package Type	Package Drawing	Pins	SPQ	Length (mm)	Width (mm)	Height (mm)
TLV62150ARGTR	VQFN	RGT	16	3000	346.0	346.0	33.0
TLV62150ARGTRG4	VQFN	RGT	16	3000	346.0	346.0	33.0
TLV62150ARGTT	VQFN	RGT	16	250	182.0	182.0	20.0
TLV62150RGTR	VQFN	RGT	16	3000	552.0	346.0	36.0
TLV62150RGTRG4	VQFN	RGT	16	3000	552.0	346.0	36.0
TLV62150RGTT	VQFN	RGT	16	250	552.0	182.0	36.0

**TUBE**

\*All dimensions are nominal

Device	Package Name	Package Type	Pins	SPQ	L (mm)	W (mm)	T (μm)	B (mm)
TLV62150RGTR	RGT	VQFN	16	3000	381	4.83	2286	0
TLV62150RGTR.A	RGT	VQFN	16	3000	381	4.83	2286	0
TLV62150RGTR.B	RGT	VQFN	16	3000	381	4.83	2286	0
TLV62150RGTRG4	RGT	VQFN	16	3000	381	4.83	2286	0
TLV62150RGTRG4.A	RGT	VQFN	16	3000	381	4.83	2286	0
TLV62150RGTRG4.B	RGT	VQFN	16	3000	381	4.83	2286	0
TLV62150RGTT	RGT	VQFN	16	250	381	4.83	2286	0
TLV62150RGTT.A	RGT	VQFN	16	250	381	4.83	2286	0
TLV62150RGTT.B	RGT	VQFN	16	250	381	4.83	2286	0

**RGT 16**

**GENERIC PACKAGE VIEW**

**VQFN - 1 mm max height**

PLASTIC QUAD FLATPACK - NO LEAD



Images above are just a representation of the package family, actual package may vary.  
Refer to the product data sheet for package details.

4203495/1

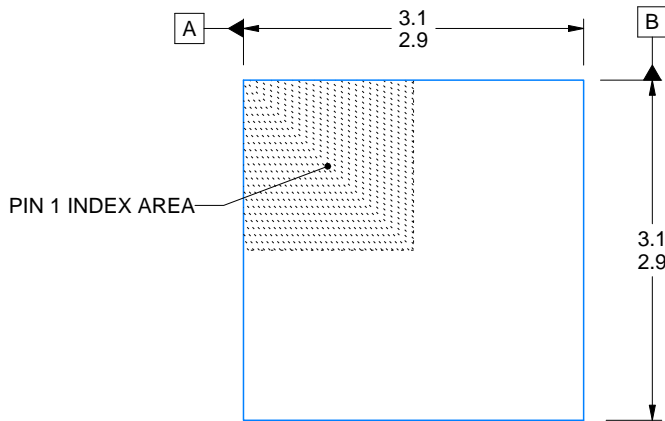
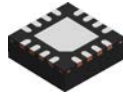

SIDE WALL METAL THICKNESS DIM A	
OPTION 1	OPTION 2
0.1	0.2

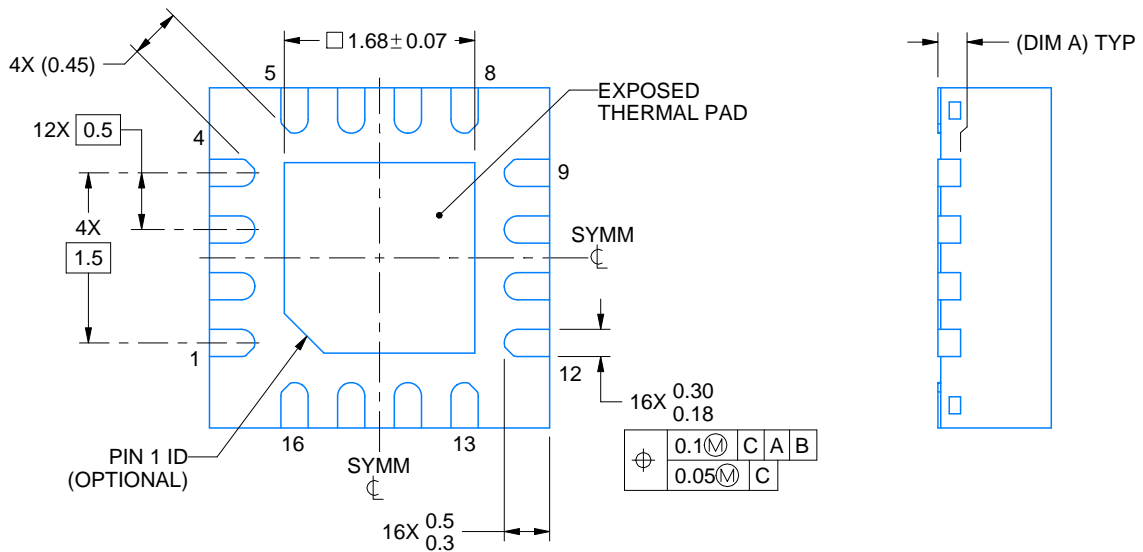
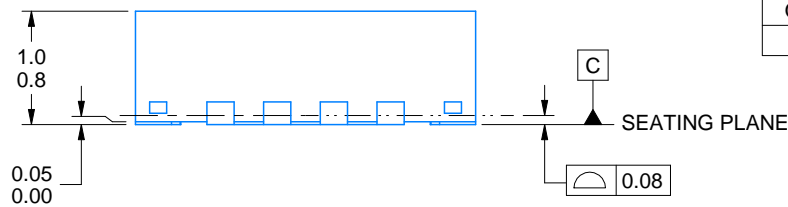

4222419/E 07/2025

NOTES:

1. All linear dimensions are in millimeters. Any dimensions in parenthesis are for reference only. Dimensioning and tolerancing per ASME Y14.5M.
2. This drawing is subject to change without notice.
3. The package thermal pad must be soldered to the printed circuit board for thermal and mechanical performance.

# EXAMPLE BOARD LAYOUT

**RGT0016C**

**VQFN - 1 mm max height**

PLASTIC QUAD FLATPACK - NO LEAD

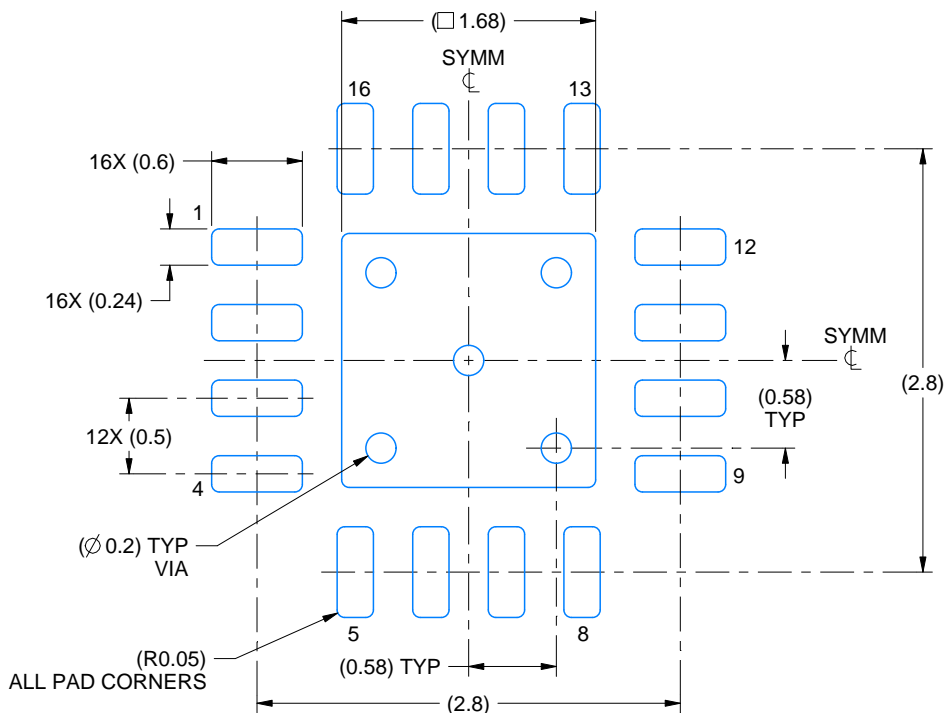

LAND PATTERN EXAMPLE  
EXPOSED METAL SHOWN  
SCALE:20X

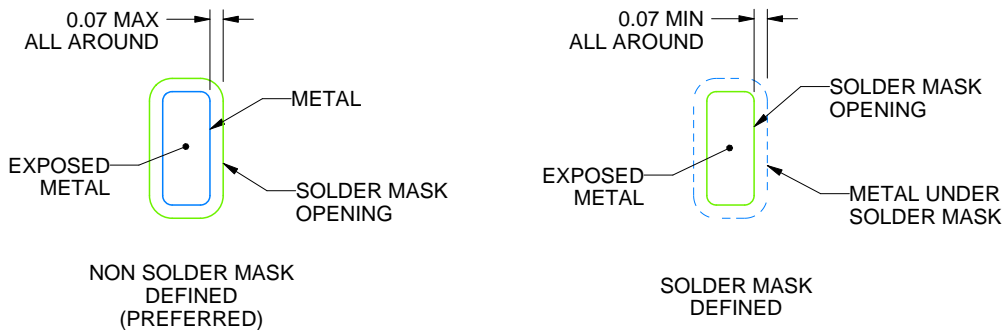

SOLDER MASK DETAILS

4222419/E 07/2025

NOTES: (continued)

- This package is designed to be soldered to a thermal pad on the board. For more information, see Texas Instruments literature number SLUA271 ([www.ti.com/lit/sluea271](http://www.ti.com/lit/sluea271)).
- Vias are optional depending on application, refer to device data sheet. If any vias are implemented, refer to their locations shown on this view. It is recommended that vias under paste be filled, plugged or tented.

# EXAMPLE STENCIL DESIGN

RGT0016C

VQFN - 1 mm max height

PLASTIC QUAD FLATPACK - NO LEAD

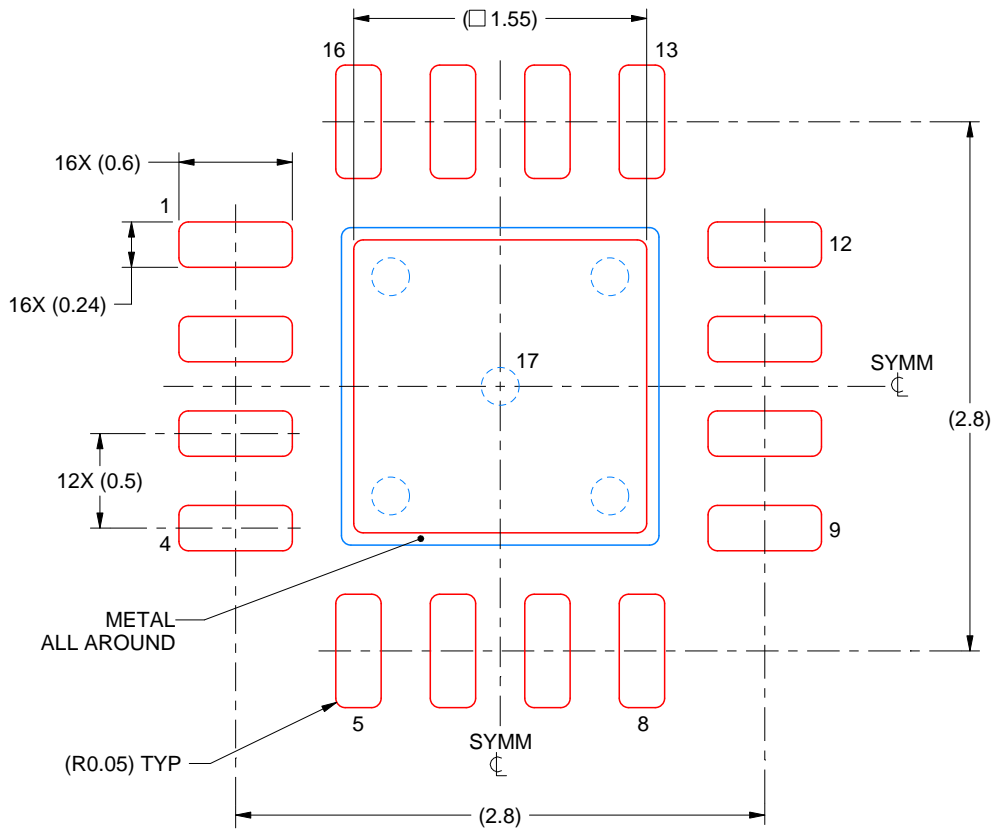

**SOLDER PASTE EXAMPLE**  
BASED ON 0.125 mm THICK STENCIL

EXPOSED PAD 17:  
85% PRINTED SOLDER COVERAGE BY AREA UNDER PACKAGE  
SCALE:25X

4222419/E 07/2025

NOTES: (continued)

6. Laser cutting apertures with trapezoidal walls and rounded corners may offer better paste release. IPC-7525 may have alternate design recommendations.



## IMPORTANT NOTICE AND DISCLAIMER

TI PROVIDES TECHNICAL AND RELIABILITY DATA (INCLUDING DATASHEETS), DESIGN RESOURCES (INCLUDING REFERENCE DESIGNS), APPLICATION OR OTHER DESIGN ADVICE, WEB TOOLS, SAFETY INFORMATION, AND OTHER RESOURCES "AS IS" AND WITH ALL FAULTS, AND DISCLAIMS ALL WARRANTIES, EXPRESS AND IMPLIED, INCLUDING WITHOUT LIMITATION ANY IMPLIED WARRANTIES OF MERCHANTABILITY, FITNESS FOR A PARTICULAR PURPOSE OR NON-INFRINGEMENT OF THIRD PARTY INTELLECTUAL PROPERTY RIGHTS.

These resources are intended for skilled developers designing with TI products. You are solely responsible for (1) selecting the appropriate TI products for your application, (2) designing, validating and testing your application, and (3) ensuring your application meets applicable standards, and any other safety, security, regulatory or other requirements.

These resources are subject to change without notice. TI grants you permission to use these resources only for development of an application that uses the TI products described in the resource. Other reproduction and display of these resources is prohibited. No license is granted to any other TI intellectual property right or to any third party intellectual property right. TI disclaims responsibility for, and you fully indemnify TI and its representatives against any claims, damages, costs, losses, and liabilities arising out of your use of these resources.

TI's products are provided subject to [TI's Terms of Sale](#), [TI's General Quality Guidelines](#), or other applicable terms available either on [ti.com](http://ti.com) or provided in conjunction with such TI products. TI's provision of these resources does not expand or otherwise alter TI's applicable warranties or warranty disclaimers for TI products. Unless TI explicitly designates a product as custom or customer-specified, TI products are standard, catalog, general purpose devices.

TI objects to and rejects any additional or different terms you may propose.

Copyright © 2025, Texas Instruments Incorporated

Last updated 10/2025