

TLV2442, TLV2442A, TLV2444, TLV2444A Advanced LinCMOS™ RAIL-TO-RAIL OUTPUT WIDE-INPUT-VOLTAGE OPERATIONAL AMPLIFIERS

SLOS169H – NOVEMBER 1996 – REVISED MARCH 2001

- Output Swing Includes Both Supply Rails
- Extended Common-Mode Input Voltage Range . . . 0 V to 4.25 V (Min) at 5-V Single Supply
- No Phase Inversion
- Low Noise . . . 16 nV/√Hz Typ at f = 1 kHz
- Low Input Offset Voltage
950 μV Max at T_A = 25°C (TLV244xA)
- Low Input Bias Current . . . 1 pA Typ
- 600-Ω Output Drive
- High-Gain Bandwidth . . . 1.8 MHz Typ
- Low Supply Current . . . 750 μA Per Channel Typ
- Macromodel Included
- Available in Q-Temp Automotive
HighRel Automotive Applications
Configuration Control/Print Support
Qualification to Automotive Standards

description

The TLV244x and TLV244xA are low-voltage operational amplifiers from Texas Instruments. The common-mode input voltage range of these devices has been extended over typical standard CMOS amplifiers, making them suitable for a wide range of applications. In addition, these devices do not phase invert when the common-mode input is driven to the supply rails. This satisfies most design requirements without paying a premium for rail-to-rail input performance. They also exhibit rail-to-rail output performance for increased dynamic range in single- or split-supply applications. This family is fully characterized at 3-V and 5-V supplies and is optimized for low-voltage operation. Both devices offer comparable ac performance while having lower noise, input offset voltage, and power dissipation than existing CMOS operational amplifiers. The TLV244x has increased output drive over previous rail-to-rail operational amplifiers and can drive 600-Ω loads for telecommunications applications.

The other members in the TLV244x family are the low-power, TLV243x, and micro-power, TLV2422, versions.

The TLV244x, exhibiting high input impedance and low noise, is excellent for small-signal conditioning for high-impedance sources, such as piezoelectric transducers. Because of the micropower dissipation levels and low-voltage operation, these devices work well in hand-held monitoring and remote-sensing applications. In addition, the rail-to-rail output feature with single- or split-supplies makes this family a great choice when interfacing with analog-to-digital converters (ADCs). For precision applications, the TLV244xA is available with a maximum input offset voltage of 950 μV.

If the design requires single operational amplifiers, see the TI TLV2211/21/31. This is a family of rail-to-rail output operational amplifiers in the SOT-23 package. Their small size and low power consumption make them ideal for high density, battery-powered equipment.

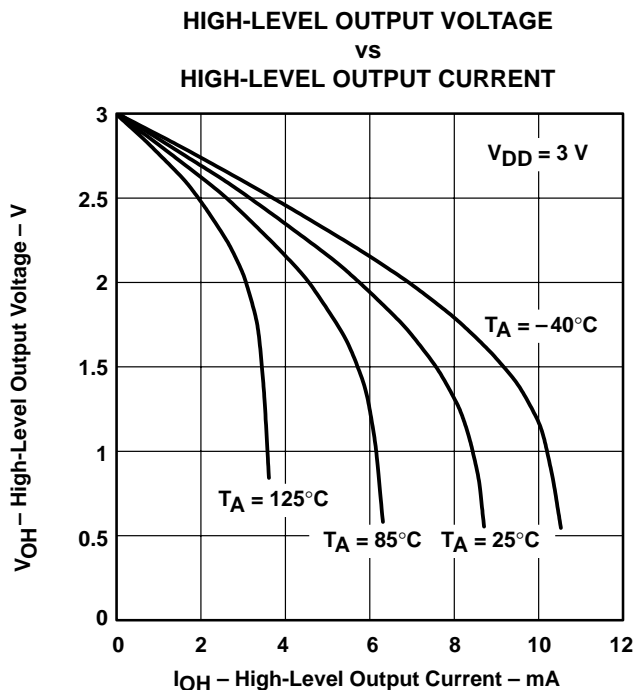

Figure 1



Please be aware that an important notice concerning availability, standard warranty, and use in critical applications of Texas Instruments semiconductor products and disclaimers thereto appears at the end of this data sheet.

Advanced LinCMOS is a trademark of Texas Instruments.

PRODUCTION DATA information is current as of publication date. Products conform to specifications per the terms of Texas Instruments standard warranty. Production processing does not necessarily include testing of all parameters.

 **TEXAS
INSTRUMENTS**

POST OFFICE BOX 655303 • DALLAS, TEXAS 75265

Copyright © 2001, Texas Instruments Incorporated
On products compliant to MIL-PRF-38535, all parameters are tested unless otherwise noted. On all other products, production processing does not necessarily include testing of all parameters.

TLV2442, TLV2442A, TLV2444, TLV2444A

Advanced LinCMOS™ RAIL-TO-RAIL OUTPUT

WIDE-INPUT-VOLTAGE OPERATIONAL AMPLIFIERS

SLOS169H – NOVEMBER 1996 – REVISED MARCH 2001

TLV2442 AVAILABLE OPTIONS

T _A	V _{IO} max AT 25°C	PACKAGED DEVICES				
		SMALL OUTLINE (D)	CHIP CARRIER (FK)	CERAMIC DIP (JG)	TSSOP (PW)	CERAMIC FLAT PACK (U)
0°C to 70°C	2.5 mV	TLV2442CD	—	—	TLV2442CPW	—
–40°C to 85°C	950 μV 2.5 mV	TLV2442AID TLV2442ID	—	—	TLV2442AIPW —	—
–40°C to 125°C	950 μV 2.5 mV	TLV2442AQD TLV2442QD	—	—	TLV2442AQPW TLV2442QPW	—
–55°C to 125°C	950 μV 2.5 mV	—	TLV2442AMFK TLV2442MFK	TLV2442AMJG TLV2442MJG	—	TLV2442AMU TLV2442MU

The D and PW packages are available taped and reeled. Add R suffix to device type (e.g., TLV2442CDR).

TLV2444 AVAILABLE OPTIONS

T _A	V _{IO} max AT 25°C	PACKAGED DEVICES	
		SMALL OUTLINE (D)	TSSOP (PW)
0°C to 70°C	2.5 mV	TLV2444CD	TLV2444CPW
–40°C to 125°C	950 μV 2.5 mV	TLV2444AID TLV2444ID	TLV2444AIPW TLV2444IPW

The D and PW packages are available taped and reeled. Add R suffix to device type (e.g., TLV2444CDR).

**TLV2442
D OR JG PACKAGE
(TOP VIEW)**

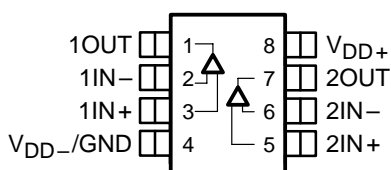

**TLV2442
PW PACKAGE
(TOP VIEW)**

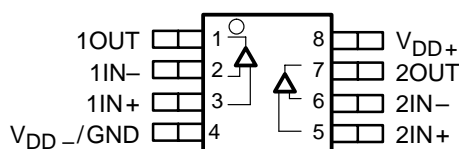

**TLV2442
FK PACKAGE
(TOP VIEW)**

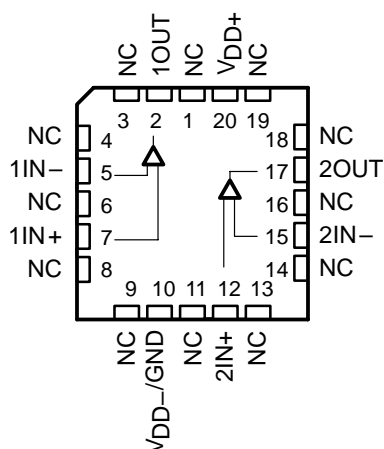

**TLV2442
U PACKAGE
(TOP VIEW)**

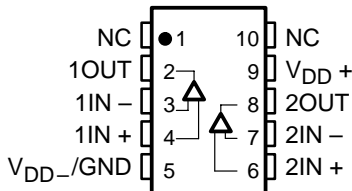

**TLV2444
D OR PW PACKAGE
(TOP VIEW)**

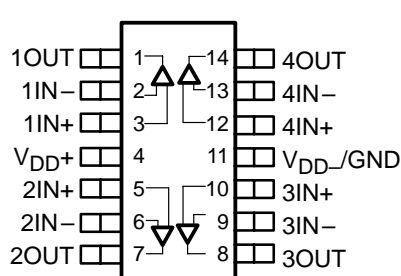

NC – No internal connection



POST OFFICE BOX 655303 • DALLAS, TEXAS 75265

equivalent schematic (each amplifier)



COMPONENT COUNT	
Transistors	69
Diodes	5
Resistors	26
Capacitors	6

TLV2442, TLV2442A, TLV2444, TLV2444A
Advanced LinCMOS™ RAIL-TO-RAIL OUTPUT
WIDE-INPUT-VOLTAGE OPERATIONAL AMPLIFIERS

SLOS169H – NOVEMBER 1996 – REVISED MARCH 2001

absolute maximum ratings over operating free-air temperature range (unless otherwise noted)†

Supply voltage, V_{DD} (see Note 1)	12 V
Differential input voltage, V_{ID} (see Note 2)	$\pm V_{DD}$
Input voltage, V_I (any input, see Note 1)	-0.3 V to V_{DD}
Input current, I_I (any input)	± 5 mA
Output current, I_O	± 50 mA
Total current into V_{DD+}	± 50 mA
Total current out of V_{DD-}	± 50 mA
Duration of short-circuit current at (or below) 25°C (see Note 3)	unlimited
Continuous total dissipation	See Dissipation Rating Table
Operating free-air temperature range, T_A : C suffix	0°C to 70°C
I suffix (dual)	-40°C to 85°C
I suffix (quad)	-40°C to 125°C
Q suffix	-40°C to 125°C
M suffix	-55°C to 125°C
Storage temperature range, T_{stg}	-65°C to 150°C
Lead temperature 1,6 mm (1/16 inch) from case for 10 seconds	260°C

† Stresses beyond those listed under “absolute maximum ratings” may cause permanent damage to the device. These are stress ratings only, and functional operation of the device at these or any other conditions beyond those indicated under “recommended operating conditions” is not implied. Exposure to absolute-maximum-rated conditions for extended periods may affect device reliability.

- NOTES: 1. All voltage values, except differential voltages, are with respect to the midpoint between V_{DD+} and V_{DD-} .
 2. Differential voltages are at $IN+$ with respect to $IN-$. Excessive current will flow if input is brought below $V_{DD-} - 0.3$ V.
 3. The output may be shorted to either supply. Temperature and/or supply voltages must be limited to ensure that the maximum dissipation rating is not exceeded.

DISSIPATION RATING TABLE

PACKAGE	$T_A \leq 25^\circ\text{C}$ POWER RATING	DERATING FACTOR ABOVE $T_A = 25^\circ\text{C}$	$T_A = 70^\circ\text{C}$ POWER RATING	$T_A = 85^\circ\text{C}$ POWER RATING	$T_A = 125^\circ\text{C}$ POWER RATING
D (8)	725 mW	5.8 mW/°C	464 mW	377 mW	145 mW
D (14)	1022 mW	7.6 mW/°C	900 mW	777 mW	450 mW
FK	1375 mW	11.0 mW/°C	880 mW	715 mW	275 mW
JG	1050 mW	8.4 mW/°C	672 mW	546 mW	210 mW
PW (8)	525 mW	4.2 mW/°C	336 mW	273 mW	105 mW
PW (14)	720 mW	5.6 mW/°C	634 mW	547 mW	317 mW
U	675 mW	5.4 mW/°C	432 mW	350 mW	135 mW

recommended operating conditions

	C SUFFIX		I SUFFIX		Q SUFFIX		M SUFFIX		UNIT
	MIN	MAX	MIN	MAX	MIN	MAX	MIN	MAX	
Supply voltage, V_{DD}	2.7	10	2.7	10	2.7	10	2.7	10	V
Input voltage range, V_I	V_{DD-}	$V_{DD+} - 1$	V_{DD-}	$V_{DD+} - 1$	V_{DD-}	$V_{DD+} - 1.3$	V_{DD-}	$V_{DD+} - 1.3$	V
Common-mode input voltage, V_{IC}	V_{DD-}	$V_{DD+} - 1$	V_{DD-}	$V_{DD+} - 1$	$V_{DD-} + 2$	$V_{DD+} - 1.3$	$V_{DD-} + 2$	$V_{DD+} - 1.3$	V
Operating free-air temperature, T_A	0	70	-40	125	-40	125	-55	125	°C



TLV2442, TLV2442A, TLV2444, TLV2444A
Advanced LinCMOS™ RAIL-TO-RAIL OUTPUT
WIDE-INPUT-VOLTAGE OPERATIONAL AMPLIFIERS

SLOS169H – NOVEMBER 1996 – REVISED MARCH 2001

electrical characteristics at specified free-air temperature, $V_{DD} = 3\text{ V}$ (unless otherwise noted)

PARAMETER	TEST CONDITIONS	T_A †	TLV2442			UNIT
			MIN	TYP	MAX	
V_{IO} Input offset voltage	$V_{IC} = 1.5\text{ V}$, $V_O = 1.5\text{ V}$, $R_S = 50\ \Omega$	TLV244xC TLV244xI	25°C	300	2000	μV
			Full range	2500		
		TLV244xAI	25°C	300	950	
			Full range	1500		
		TLV2442AQ TLV2442AM	25°C	300	950	
			Full range	1600		
α_{VIO} Temperature coefficient of input offset voltage		25°C to 85°C	2		$\mu\text{V}/^\circ\text{C}$	
Input offset voltage long-term drift (see Note 4)		25°C	0.002		$\mu\text{V}/\text{mo}$	
I_{IO} Input offset current		25°C	0.5	60	pA	
		Full range	150			
I_{IB} Input bias current		25°C	1	60	pA	
		-40°C to 85°C	150			
		125°C	350			
		TLV2442Q/AQ TLV2442M/AM	Full range	260		
V_{ICR} Common-mode input voltage range	$ V_{IO} \leq 5\text{ mV}$, $R_S = 50\ \Omega$	25°C	0 to 2.25	-0.25 to 2.5	V	
		Full range	0 to 2			
		25°C to -55°C	0 to 2.25	-0.25 to 2.5		
		125°C	0 to 2			
V_{OH} High-level output voltage	$I_O = -100\ \mu\text{A}$	25°C	2.98		V	
		25°C	2.5			
		Full range	2.25			
V_{OL} Low-level output voltage	$V_{IC} = 1.5\text{ V}$, $I_O = 100\ \mu\text{A}$	25°C	0.02		V	
		25°C	0.63			
		Full range	1			
A_{VD} Large-signal differential voltage amplification	$V_O = 1\text{ V to }2\text{ V}$	$R_L = 600\ \Omega$	25°C	0.7	1	V/mV
			Full range	0.4		
		$R_L = 1\ \text{M}\Omega$	25°C	750		
r_{id} Differential input resistance		25°C	1000		$\text{G}\Omega$	
r_i Common-mode input resistance		25°C	1000		$\text{G}\Omega$	
c_i Common-mode input capacitance	$f = 10\ \text{kHz}$	25°C	8		pF	
z_o Closed-loop output impedance	$f = 1\ \text{MHz}$, $A_V = 10$	25°C	130		Ω	

† Full range for the C suffix is 0°C to 70°C. Full range for the dual I suffix is -40°C to 85°C. Full range for the quad I suffix is -40°C to 125°C. Full range for the Q suffix is -40°C to 125°C. Full range for the M suffix is -55°C to 125°C.

NOTE 4: Typical values are based on the input offset voltage shift observed through 168 hours of operating life test at $T_A = 150^\circ\text{C}$ extrapolated to $T_A = 25^\circ\text{C}$ using the Arrhenius equation and assuming an activation energy of 0.96 eV.



TLV2442, TLV2442A, TLV2444, TLV2444A
Advanced LinCMOS™ RAIL-TO-RAIL OUTPUT
WIDE-INPUT-VOLTAGE OPERATIONAL AMPLIFIERS

SLOS169H – NOVEMBER 1996 – REVISED MARCH 2001

electrical characteristics at specified free-air temperature, $V_{DD} = 3\text{ V}$ (unless otherwise noted) (continued)

PARAMETER	TEST CONDITIONS	T_A †	TLV2442			UNIT
			MIN	TYP	MAX	
CMRR Common-mode rejection ratio	$V_{IC} = 0\text{ to }2.25\text{ V}$, $V_O = 1.5\text{ V}$, $R_S = 50\ \Omega$	25°C	65	75		dB
		Full range	55			
		TLV2442Q/AQ TLV2442M/AM	Full range	50		
k_{SVR} Supply-voltage rejection ratio ($\Delta V_{DD} \pm / \Delta V_{IO}$)	$V_{DD} = 2.7\text{ V to }8\text{ V}$, No load $V_{IC} = V_{DD}/2$,	25°C	80	95		dB
		Full range	80			
I_{DD} Supply current (per channel)	$V_O = 1.5\text{ V}$, No load	25°C		725	1100	μA
		Full range			1100	

† Full range for the C suffix is 0°C to 70°C. Full range for the dual I suffix is –40°C to 85°C. Full range for the quad I suffix is –40°C to 125°C. Full range for the Q suffix is –40°C to 125°C. Full range for the M suffix is –55°C to 125°C.

operating characteristics at specified free-air temperature, $V_{DD} = 3\text{ V}$

PARAMETER	TEST CONDITIONS	T_A †	TLV244x			UNIT
			MIN	TYP	MAX	
SR Slew rate at unity gain	$V_O = 1\text{ V to }2\text{ V}$, $R_L = 600\ \Omega$, $C_L = 100\text{ pF}$	25°C	0.65	1.3		$\text{V}/\mu\text{s}$
		Full range	0.65			
		TLV2442Q/AQ TLV2442M/AM	Full range	0.4		
V_n Equivalent input noise voltage	$f = 10\text{ Hz}$	25°C		170		$\text{nV}/\sqrt{\text{Hz}}$
	$f = 1\text{ kHz}$	25°C		18		
$V_{N(PP)}$ Peak-to-peak equivalent input noise voltage	$f = 0.1\text{ Hz to }1\text{ Hz}$	25°C		2.6		μV
	$f = 0.1\text{ Hz to }10\text{ Hz}$	25°C		5.1		
I_n Equivalent input noise current		25°C		0.6		$\text{fA}/\sqrt{\text{Hz}}$
THD + N Total harmonic distortion plus noise	$V_O = 0.5\text{ V to }2.5\text{ V}$, $R_L = 600\ \Omega$, $f = 1\text{ kHz}$	25°C	$A_V = 1$	0.08%		
			$A_V = 10$	0.3%		
			$A_V = 100$	2%		
Gain-bandwidth product	$f = 10\text{ kHz}$, $C_L = 100\text{ pF}$	$R_L = 600\ \Omega$, 25°C		1.75		MHz
BOM Maximum output-swing bandwidth	$V_{O(PP)} = 1\text{ V}$, $A_V = 1$,	$R_L = 600\ \Omega$, $C_L = 100\text{ pF}$, 25°C		0.9		MHz
t_s Settling time	$A_V = -1$, Step = –2.3 V to 2.3 V, $R_L = 600\ \Omega$, $C_L = 100\text{ pF}$	25°C	To 0.1%	1.5		μs
			To 0.01%	3.2		
ϕ_m Phase margin at unity gain	$R_L = 600\ \Omega$, $C_L = 100\text{ pF}$	25°C		65°		
Gain margin		25°C		9		dB

† Full range for the C suffix is 0°C to 70°C. Full range for the dual I suffix is –40°C to 85°C. Full range for the quad I suffix is –40°C to 125°C. Full range for the Q suffix is –40°C to 125°C. Full range for the M suffix is –55°C to 125°C.



TLV2442, TLV2442A, TLV2444, TLV2444A
Advanced LinCMOS™ RAIL-TO-RAIL OUTPUT
WIDE-INPUT-VOLTAGE OPERATIONAL AMPLIFIERS

SLOS169H – NOVEMBER 1996 – REVISED MARCH 2001

electrical characteristics at specified free-air temperature, $V_{DD} = 5\text{ V}$ (unless otherwise noted)

PARAMETER	TEST CONDITIONS	T_A †	TLV244x			UNIT
			MIN	TYP	MAX	
V_{IO} Input offset voltage	$V_{DD\pm} = \pm 2.5\text{ V}$, $V_O = 0$, $V_{IC} = 0$, $R_S = 50\ \Omega$	TLV244xC TLV244xI	25°C	300	2000	μV
			Full range	2500		
		TLV244xA	25°C	300	950	
			Full range	1500		
		TLV2442AQ TLV2442AM	25°C	300	950	
			Full range	1600		
α_{VIO} Temperature coefficient of input offset voltage		25°C to 85°C	2		$\mu\text{V}/^\circ\text{C}$	
Input offset voltage long-term drift (see Note 4)		25°C	0.002		$\mu\text{V}/\text{mo}$	
I_{IO} Input offset current		25°C	0.5	60	pA	
		Full range	150			
I_{IB} Input bias current		25°C	1	60	pA	
		-40°C to 85°C	150			
		125°C	350			
		TLV2442Q/AQ TLV2442M/AM	Full range	260		
V_{ICR} Common-mode input voltage range	$ V_{IO} \leq 5\text{ mV}$, $R_S = 50\ \Omega$	25°C	0 to 4.25	-0.25 to 4.5	V	
		Full range	0 to 4			
V_{OH} High-level output voltage	$I_{OH} = -100\ \mu\text{A}$	25°C	4.97		V	
	$I_{OH} = -5\text{ mA}$	25°C	4	4.35		
		Full range	4			
V_{OL} Low-level output voltage	$V_{IC} = 2.5\text{ V}$, $I_{OL} = 100\ \mu\text{A}$	25°C	0.01		V	
	$V_{IC} = 2.5\text{ V}$, $I_{OL} = 5\text{ mA}$	25°C	0.8			
		Full range	1.25			
A_{VD} Large-signal differential voltage amplification	$V_{IC} = 2.5\text{ V}$, $V_O = 1\text{ V to }4\text{ V}$	$R_L = 600\ \Omega$ ‡	25°C	0.9	1.3	V/mV
			Full range	0.5		
		$R_L = 1\text{ M}\Omega$ ‡	25°C	950		
r_{id} Differential input resistance		25°C	1000		G Ω	
r_i Common-mode input resistance		25°C	1000		G Ω	
c_i Common-mode input capacitance	$f = 10\text{ kHz}$	25°C	8		pF	
z_o Closed-loop output impedance	$f = 1\text{ MHz}$, $A_V = 10$	25°C	140		Ω	
CMRR Common-mode rejection ratio	$V_{IC} = 0\text{ to }4.25\text{ V}$, $V_O = 2.5\text{ V}$, $R_S = 50\ \Omega$	25°C	70	75	dB	
		Full range	70			

† Full range for the C suffix is 0°C to 70°C. Full range for the dual I suffix is -40°C to 85°C. Full range for the quad I suffix is -40°C to 125°C. Full range for the Q suffix is -40°C to 125°C. Full range for the M suffix is -55°C to 125°C.

‡ Referenced to 2.5 V

NOTE 4: Typical values are based on the input offset voltage shift observed through 168 hours of operating life test at $T_A = 150^\circ\text{C}$ extrapolated to $T_A = 25^\circ\text{C}$ using the Arrhenius equation and assuming an activation energy of 0.96 eV.



TLV2442, TLV2442A, TLV2444, TLV2444A
Advanced LinCMOS™ RAIL-TO-RAIL OUTPUT
WIDE-INPUT-VOLTAGE OPERATIONAL AMPLIFIERS

SLOS169H – NOVEMBER 1996 – REVISED MARCH 2001

electrical characteristics at specified free-air temperature, $V_{DD} = 5\text{ V}$ (unless otherwise noted) (continued)

PARAMETER	TEST CONDITIONS	T_A †	TLV244x			UNIT
			MIN	TYP	MAX	
k_{SVR} Supply-voltage rejection ratio ($\Delta V_{DD}/\Delta V_{IO}$)	$V_{DD} = 4.4\text{ V to }8\text{ V}$, $V_{IC} = V_{DD}/2$, No load	25°C	80	95		dB
		Full range	80			
I_{DD} Supply current (per channel)	$V_O = 2.5\text{ V}$, No load	25°C	750	1100		μA
		Full range	1100			

† Full range for the C suffix is 0°C to 70°C. Full range for the dual I suffix is –40°C to 85°C. Full range for the quad I suffix is –40°C to 125°C. Full range for the Q suffix is –40°C to 125°C. Full range for the M suffix is –55°C to 125°C.

operating characteristics at specified free-air temperature, $V_{DD} = 5\text{ V}$

PARAMETER	TEST CONDITIONS	T_A †	TLV244x			UNIT
			MIN	TYP	MAX	
SR Slew rate at unity gain	$V_O = 0.5\text{ V to }2.5\text{ V}$, $R_L = 600\ \Omega$ ‡, $C_L = 100\text{ pF}$ ‡	25°C	0.75	1.4		$\text{V}/\mu\text{s}$
		Full range	0.75			
		Full range	0.5			
V_n Equivalent input noise voltage	$f = 10\text{ Hz}$	25°C	130			$\text{nV}/\sqrt{\text{Hz}}$
		25°C	16			
$V_{N(PP)}$ Peak-to-peak equivalent input noise voltage	$f = 0.1\text{ Hz to }1\text{ Hz}$	25°C	1.8			μV
	$f = 0.1\text{ Hz to }10\text{ Hz}$	25°C	3.6			
I_n Equivalent input noise current		25°C	0.6			$\text{fA}/\sqrt{\text{Hz}}$
THD + N Total harmonic distortion plus noise	$V_O = 1.5\text{ V to }3.5\text{ V}$, $f = 1\text{ kHz}$, $R_L = 600\ \Omega$ ‡	25°C	$A_V = 1$			
			$A_V = 10$			
			$A_V = 100$			
Gain-bandwidth product	$f = 10\text{ kHz}$, $R_L = 600\ \Omega$ ‡, $C_L = 100\text{ pF}$ ‡	25°C	1.81			MHz
BOM Maximum output-swing bandwidth	$V_{O(PP)} = 2\text{ V}$, $R_L = 600\ \Omega$ ‡, $A_V = 1$, $C_L = 100\text{ pF}$ ‡	25°C	0.5			MHz
t_s Settling time	$A_V = -1$, Step = 0.5 V to 2.5 V, $R_L = 600\ \Omega$ ‡, $C_L = 100\text{ pF}$ ‡	25°C	To 0.1%			μs
			To 0.01%			
ϕ_m Phase margin at unity gain	$R_L = 600\ \Omega$ ‡, $C_L = 100\text{ pF}$ ‡	25°C	68°			
Gain margin		25°C	8			dB

† Full range for the C suffix is 0°C to 70°C. Full range for the dual I suffix is –40°C to 85°C. Full range for the quad I suffix is –40°C to 125°C. Full range for the Q suffix is –40°C to 125°C. Full range for the M suffix is –55°C to 125°C.

‡ Referenced to 2.5 V



TLV2442, TLV2442A, TLV2444, TLV2444A
Advanced LinCMOS™ RAIL-TO-RAIL OUTPUT
WIDE-INPUT-VOLTAGE OPERATIONAL AMPLIFIERS

SLOS169H – NOVEMBER 1996 – REVISED MARCH 2001

TYPICAL CHARACTERISTICS

Table of Graphs†

			FIGURE
V_{IO}	Input offset voltage	Distribution vs Common-mode input voltage	2, 3 4, 5
αV_{IO}	Input offset voltage temperature coefficient	Distribution	6, 7
I_{IB}/I_{IO}	Input bias and input offset currents	vs Free-air temperature	8
V_{OH}	High-level output voltage	vs High-level output current	9, 10
V_{OL}	Low-level output voltage	vs Low-level output current	11, 12
$V_{O(PP)}$	Maximum peak-to-peak output voltage	vs Frequency	13
I_{OS}	Short-circuit output current	vs Supply voltage vs Free-air temperature	14 15
V_O	Output voltage	vs Differential Input voltage	16, 17
A_{VD}	Differential voltage amplification	vs Load resistance	18
A_{VD}	Large-signal differential voltage amplification and phase margin	vs Frequency	19, 20
	Large-signal differential voltage amplification	vs Free-air temperature	21, 22
z_o	Output impedance	vs Frequency	23, 24
CMRR	Common-mode rejection ratio	vs Frequency	25
		vs Free-air temperature	26
k_{SVR}	Supply-voltage rejection ratio	vs Frequency	27, 28
		vs Free-air temperature	29
I_{DD}	Supply current	vs Supply voltage	30
SR	Slew rate	vs Load capacitance	31
		vs Free-air temperature	32
V_O	Inverting large-signal pulse response		33, 34
	Voltage-follower large-signal pulse response		35, 36
	Inverting small-signal pulse response		37, 38
	Voltage-follower small-signal pulse response		39, 40
V_n	Equivalent input noise voltage	vs Frequency	41, 42
	Noise voltage	Over a 10-second period	43
THD + N	Total harmonic distortion plus noise	vs Frequency	44, 45
	Gain-bandwidth product	vs Free-air temperature	46
		vs Supply voltage	47
ϕ_m	Phase margin	vs Frequency	19, 20
		vs Load capacitance	48
	Gain margin	vs Load capacitance	49
B_1	Unity-gain bandwidth	vs Load capacitance	50

† For all graphs where $V_{DD} = 5$ V, all loads are referenced to 2.5 V.

TLV2442, TLV2442A, TLV2444, TLV2444A
Advanced LinCMOS™ RAIL-TO-RAIL OUTPUT
WIDE-INPUT-VOLTAGE OPERATIONAL AMPLIFIERS

SLOS169H – NOVEMBER 1996 – REVISED MARCH 2001

TYPICAL CHARACTERISTICS

**DISTRIBUTION OF TLV2442
 INPUT OFFSET VOLTAGE**

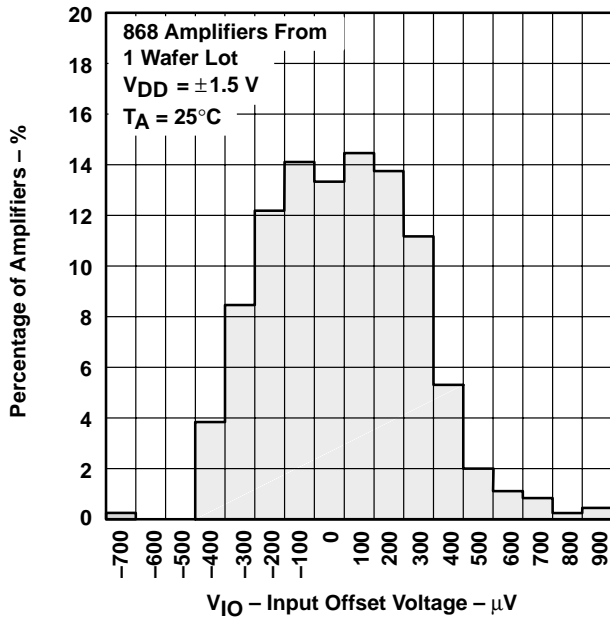

Figure 2

**DISTRIBUTION OF TLV2442
 INPUT OFFSET VOLTAGE**

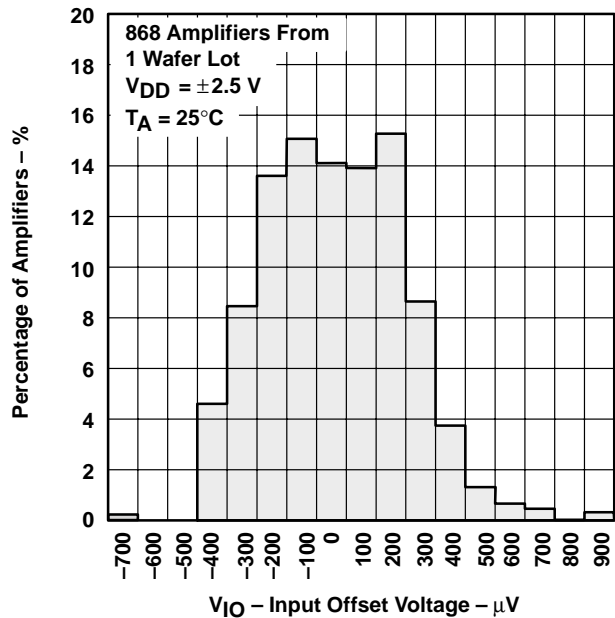

Figure 3

**INPUT OFFSET VOLTAGE
 vs
 COMMON-MODE INPUT VOLTAGE**

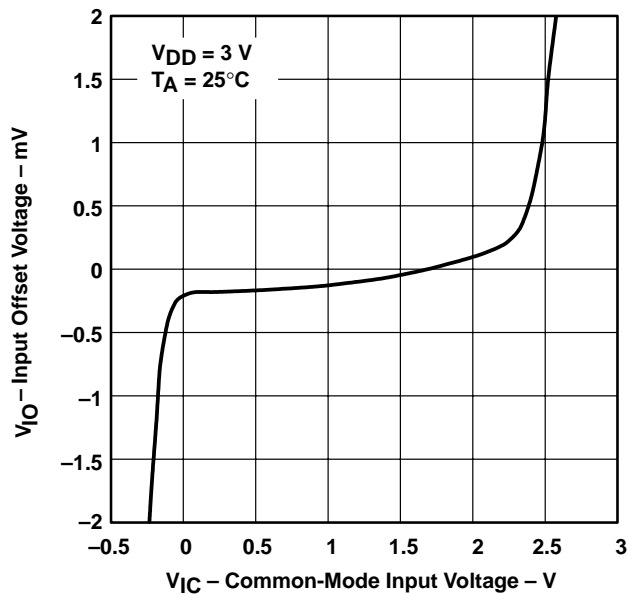

Figure 4

**INPUT OFFSET VOLTAGE
 vs
 COMMON-MODE INPUT VOLTAGE**

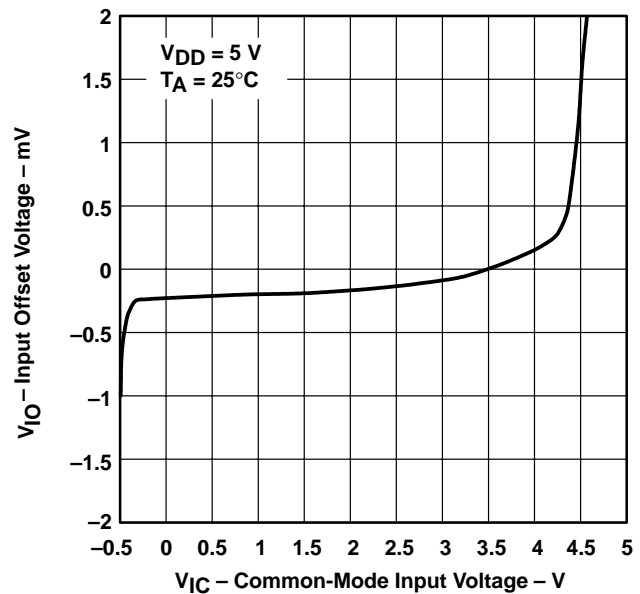

Figure 5



TYPICAL CHARACTERISTICS

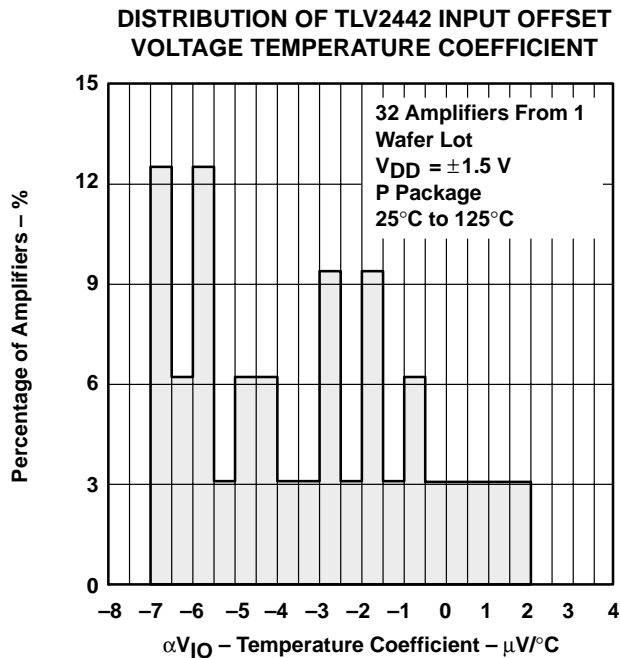

Figure 6

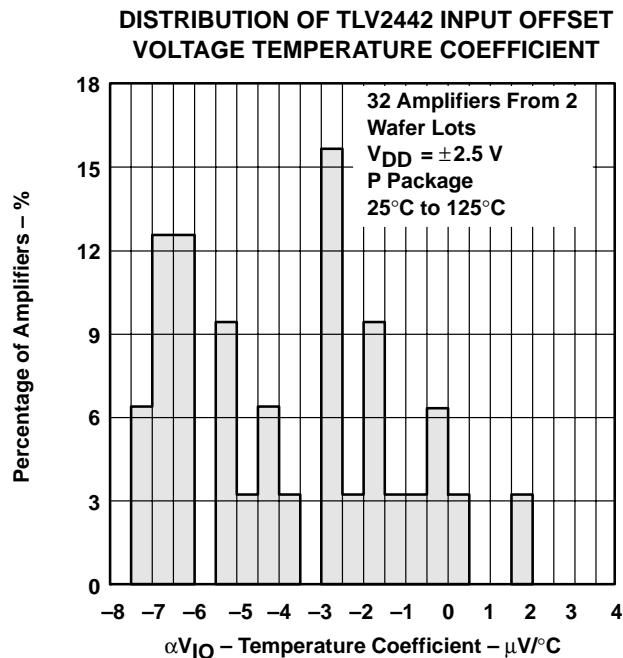

Figure 7

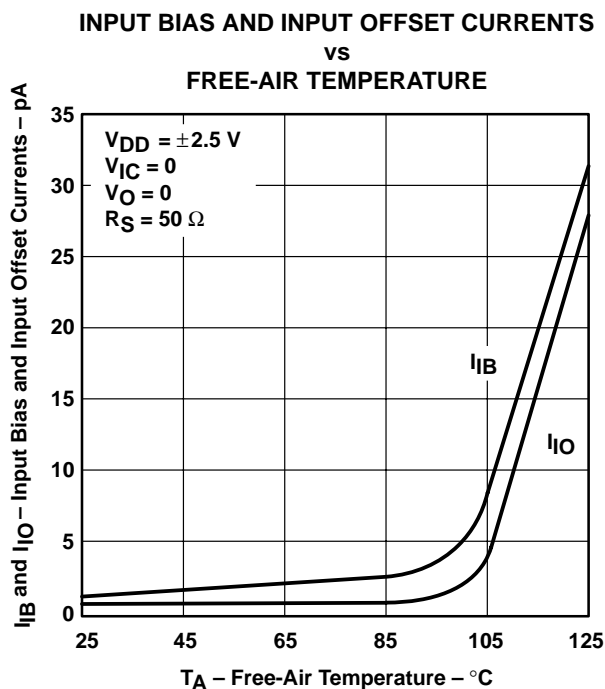

Figure 8

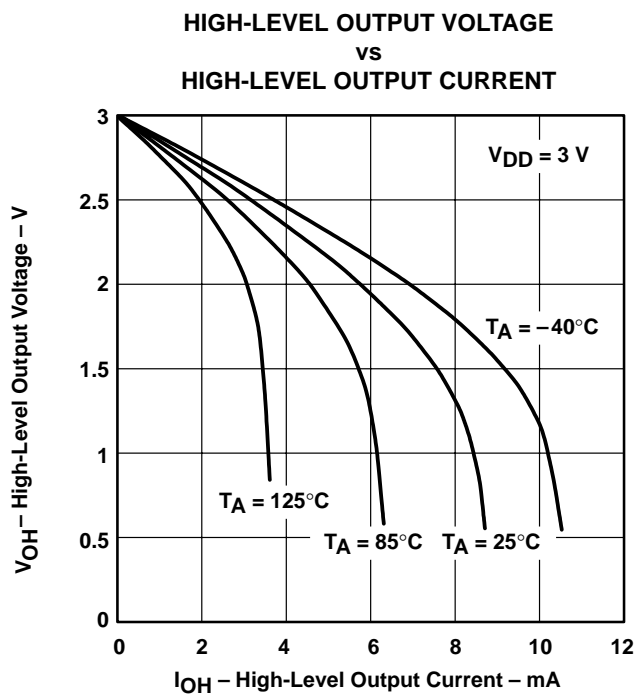

Figure 9

TLV2442, TLV2442A, TLV2444, TLV2444A
Advanced LinCMOS™ RAIL-TO-RAIL OUTPUT
WIDE-INPUT-VOLTAGE OPERATIONAL AMPLIFIERS

SLOS169H – NOVEMBER 1996 – REVISED MARCH 2001

TYPICAL CHARACTERISTICS

**HIGH-LEVEL OUTPUT VOLTAGE
vs
HIGH-LEVEL OUTPUT CURRENT**

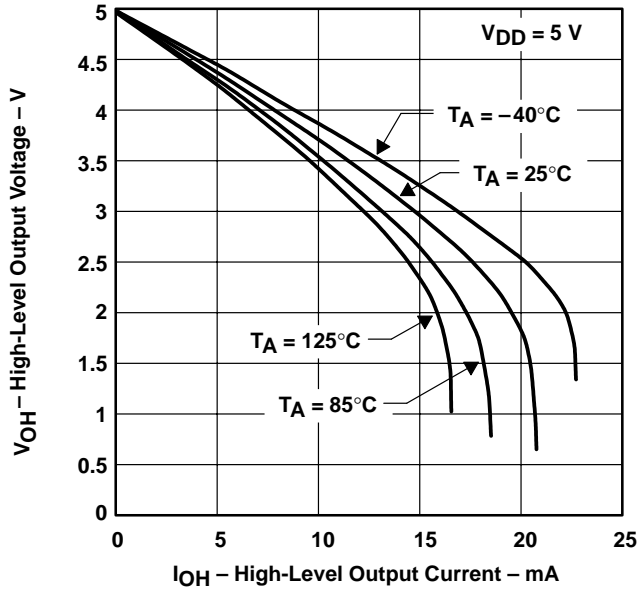

Figure 10

**LOW-LEVEL OUTPUT VOLTAGE
vs
LOW-LEVEL OUTPUT CURRENT**

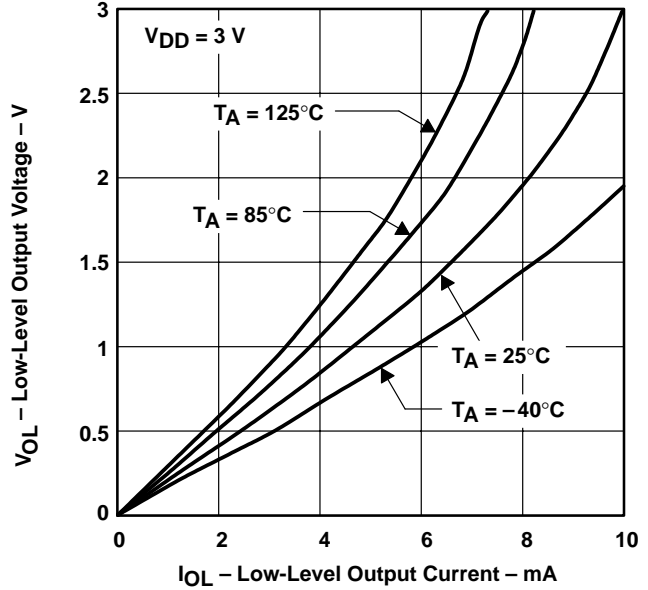

Figure 11

**LOW-LEVEL OUTPUT VOLTAGE
vs
LOW-LEVEL OUTPUT CURRENT**

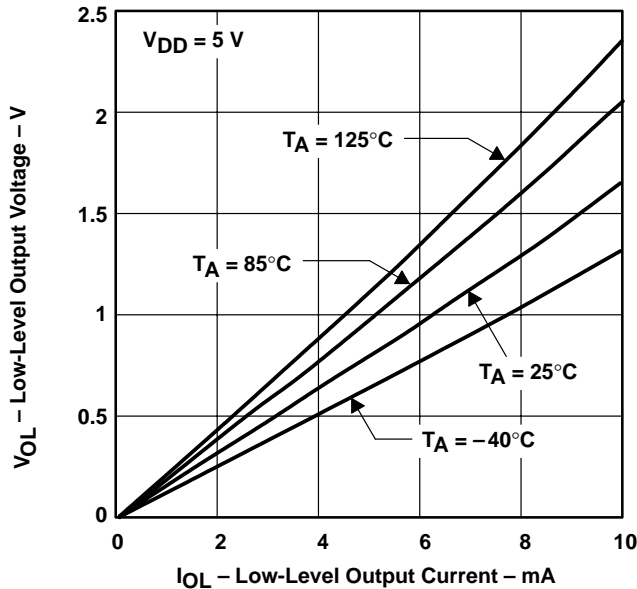

Figure 12

**MAXIMUM PEAK-TO-PEAK OUTPUT VOLTAGE
vs
FREQUENCY**

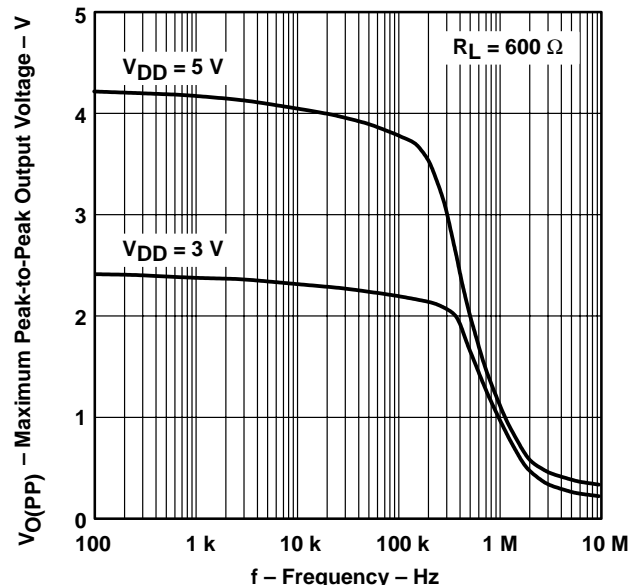
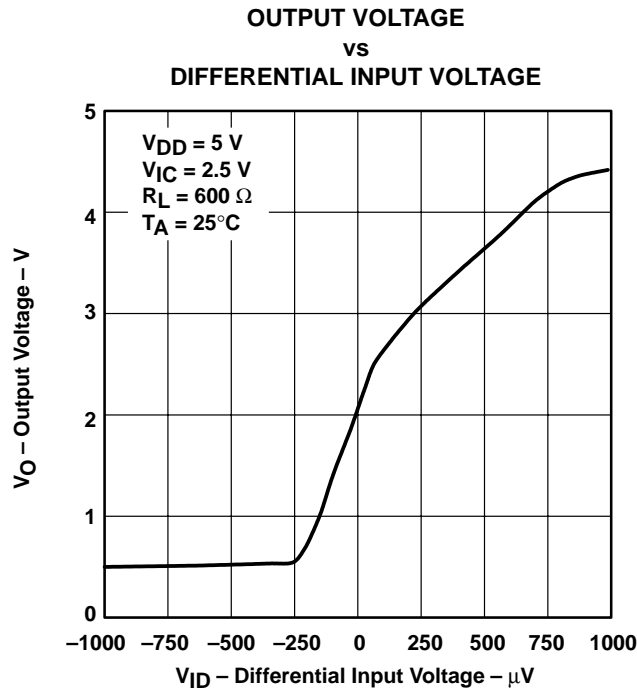
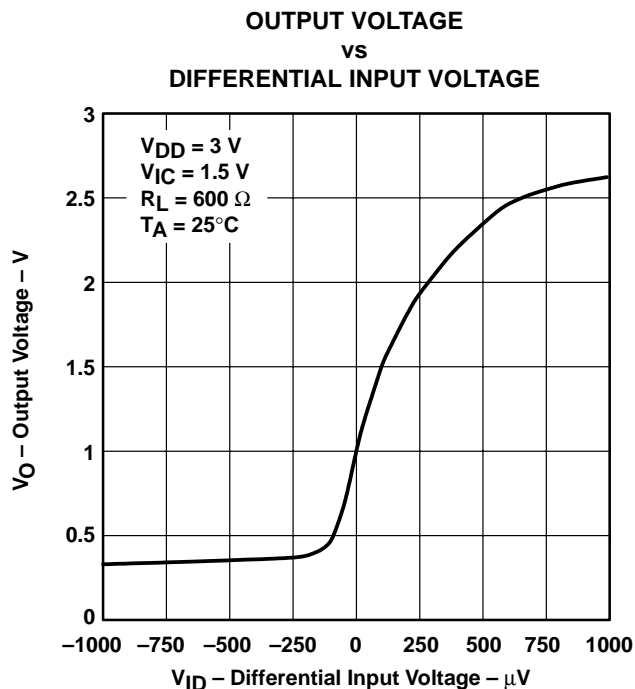
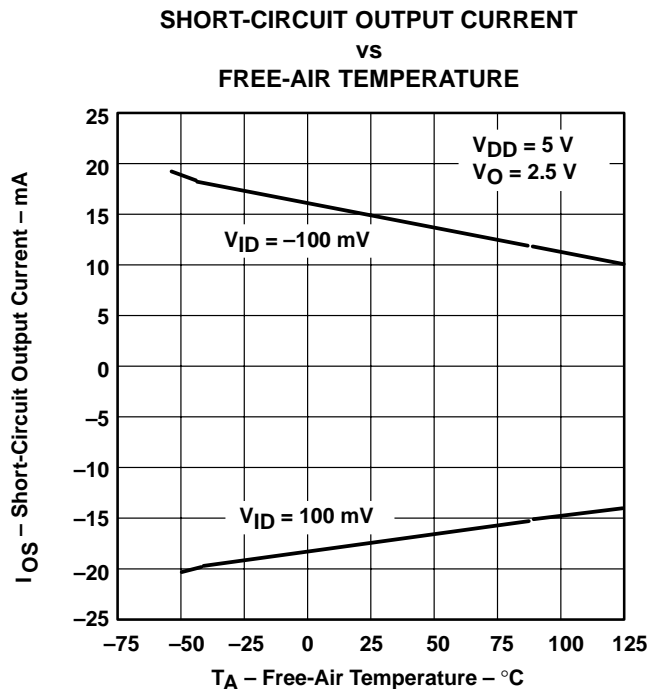
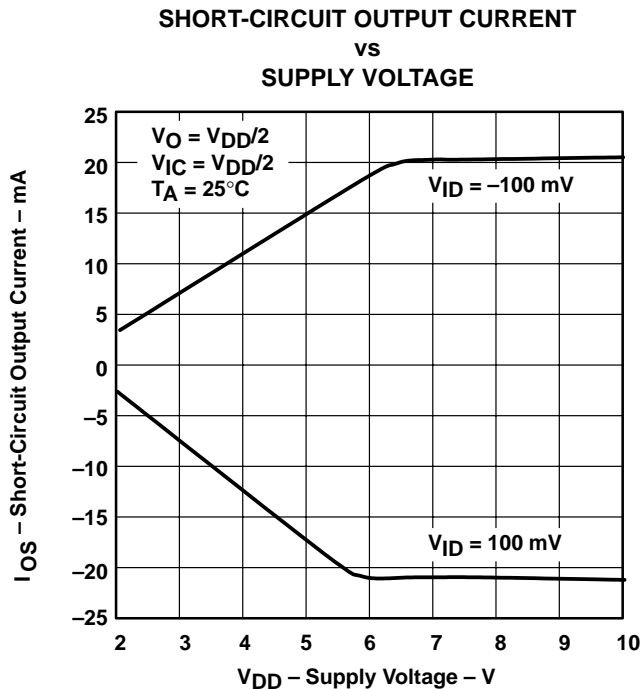

Figure 13



TYPICAL CHARACTERISTICS



TLV2442, TLV2442A, TLV2444, TLV2444A
Advanced LinCMOS™ RAIL-TO-RAIL OUTPUT
WIDE-INPUT-VOLTAGE OPERATIONAL AMPLIFIERS

SLOS169H – NOVEMBER 1996 – REVISED MARCH 2001

TYPICAL CHARACTERISTICS

DIFFERENTIAL VOLTAGE AMPLIFICATION
vs
LOAD RESISTANCE

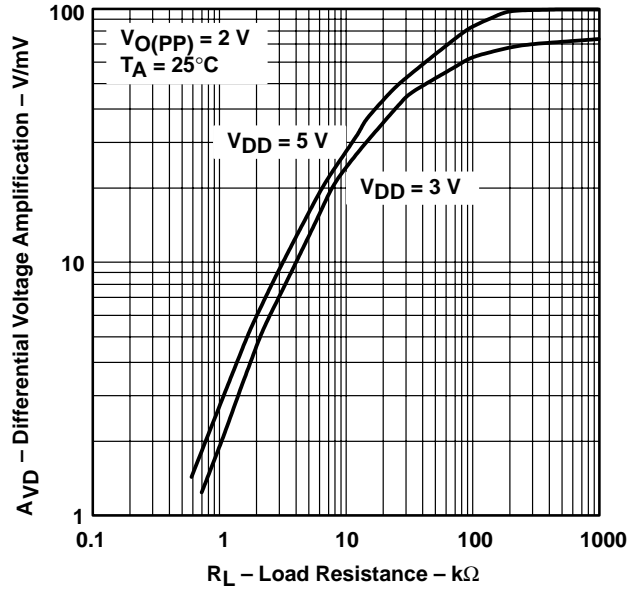

Figure 18

LARGE-SIGNAL DIFFERENTIAL VOLTAGE
AMPLIFICATION AND PHASE MARGIN
vs
FREQUENCY

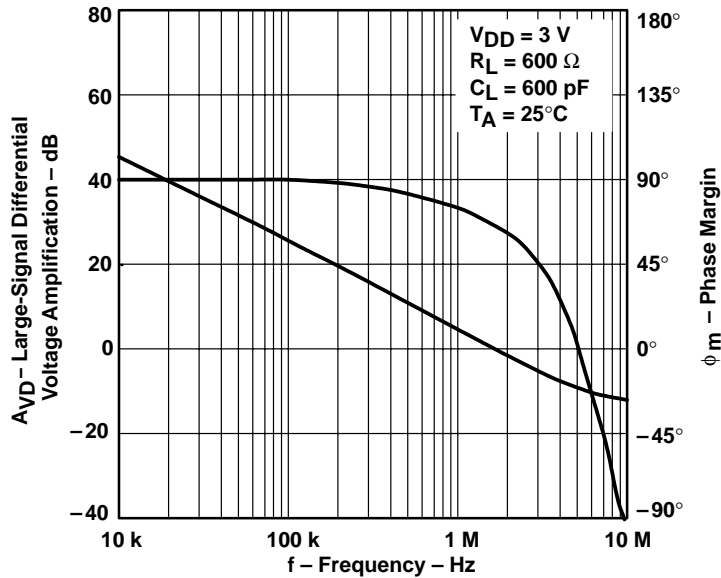

Figure 19



TYPICAL CHARACTERISTICS

LARGE-SIGNAL DIFFERENTIAL VOLTAGE
 AMPLIFICATION AND PHASE MARGIN
 vs
 FREQUENCY



Figure 20

LARGE-SIGNAL DIFFERENTIAL
 VOLTAGE AMPLIFICATION
 vs
 FREE-AIR TEMPERATURE



Figure 21

LARGE-SIGNAL DIFFERENTIAL
 VOLTAGE AMPLIFICATION
 vs
 FREE-AIR TEMPERATURE

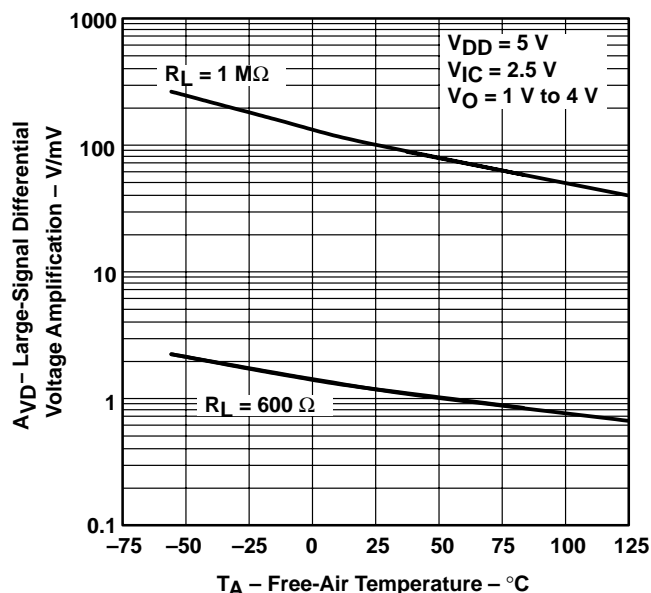

Figure 22

TYPICAL CHARACTERISTICS

OUTPUT IMPEDANCE
 vs
 FREQUENCY

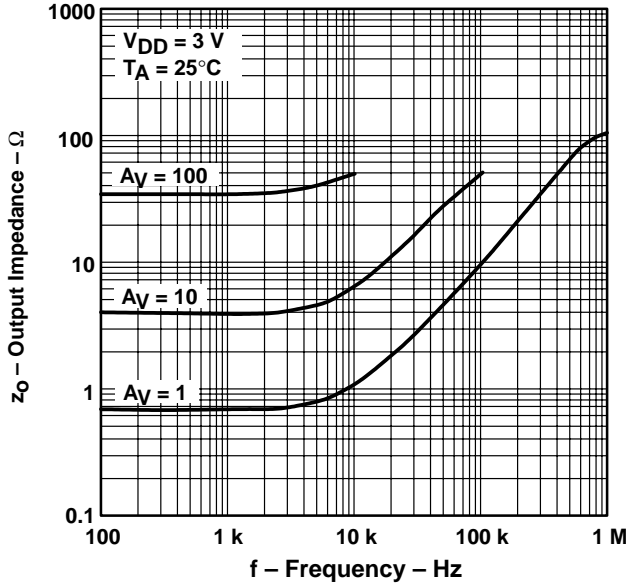

Figure 23

OUTPUT IMPEDANCE
 vs
 FREQUENCY

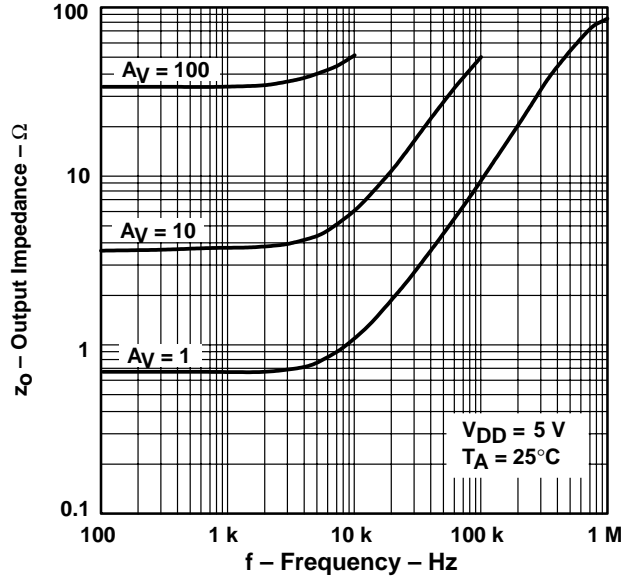

Figure 24

COMMON-MODE REJECTION RATIO
 vs
 FREQUENCY

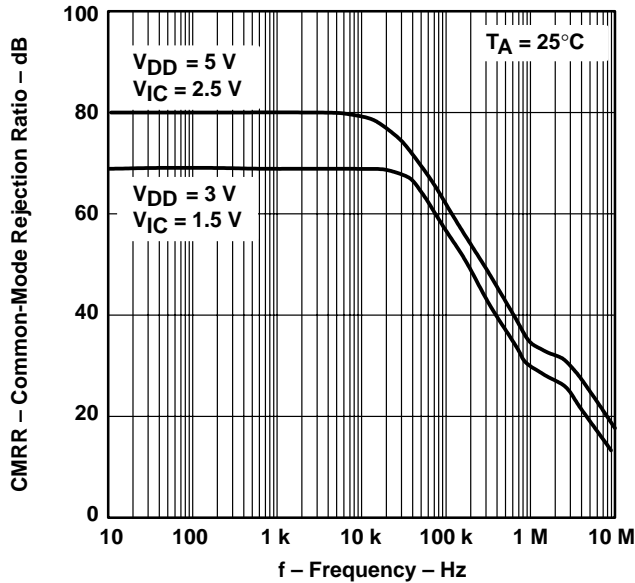

Figure 25

COMMON-MODE REJECTION RATIO
 vs
 FREE-AIR TEMPERATURE

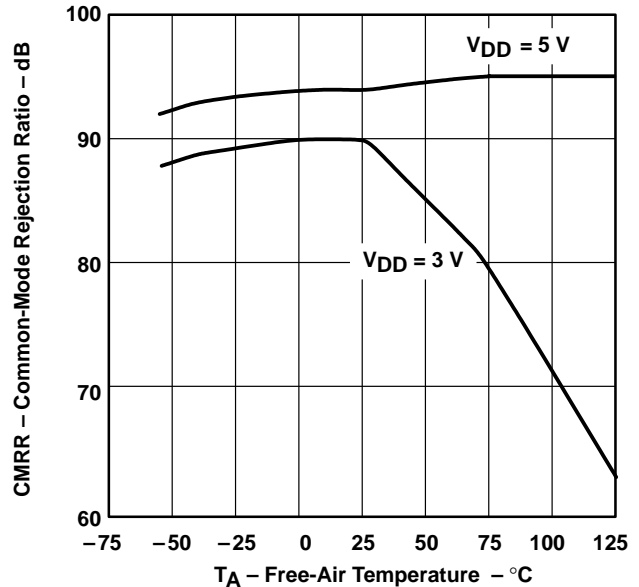

Figure 26

TYPICAL CHARACTERISTICS



Figure 27



Figure 28

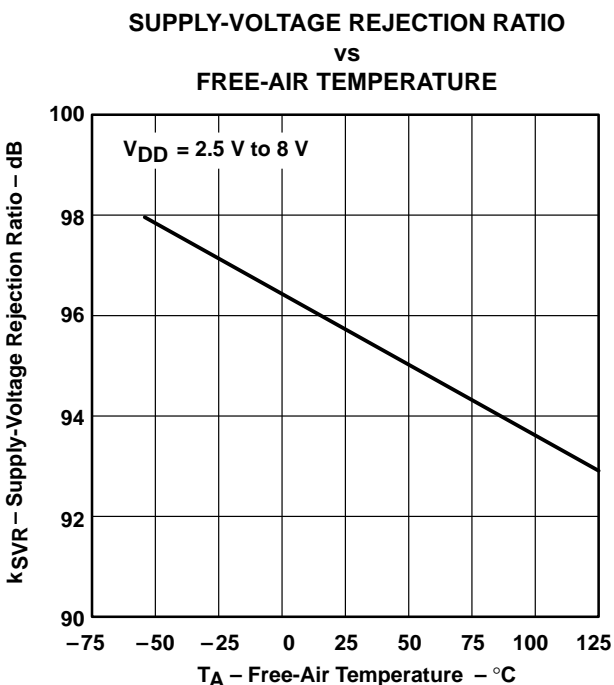

Figure 29

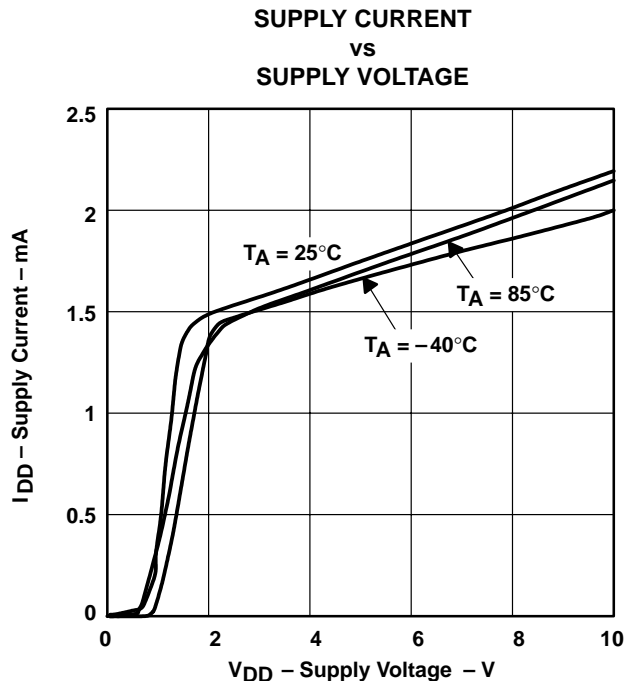

Figure 30

TLV2442, TLV2442A, TLV2444, TLV2444A
Advanced LinCMOS™ RAIL-TO-RAIL OUTPUT
WIDE-INPUT-VOLTAGE OPERATIONAL AMPLIFIERS

SLOS169H – NOVEMBER 1996 – REVISED MARCH 2001

TYPICAL CHARACTERISTICS

**SLEW RATE
vs
LOAD CAPACITANCE**

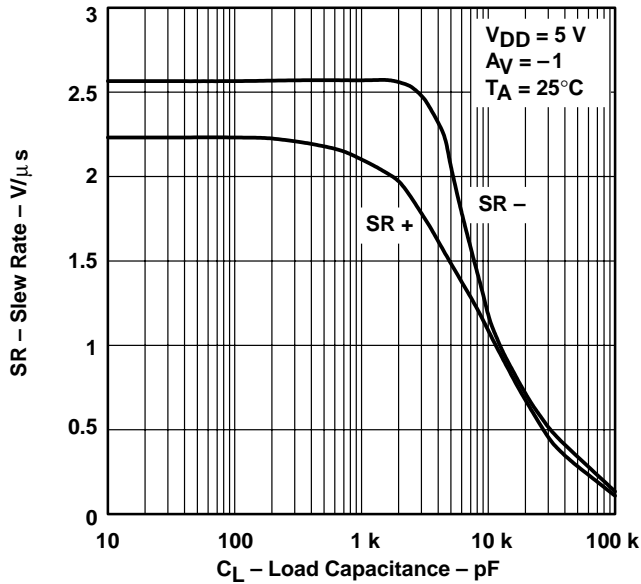

Figure 31

**SLEW RATE
vs
FREE-AIR TEMPERATURE**

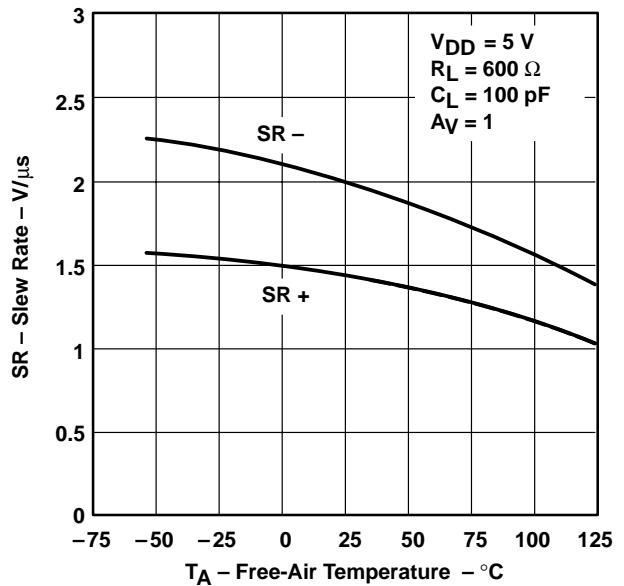

Figure 32

INVERTING LARGE-SIGNAL PULSE RESPONSE

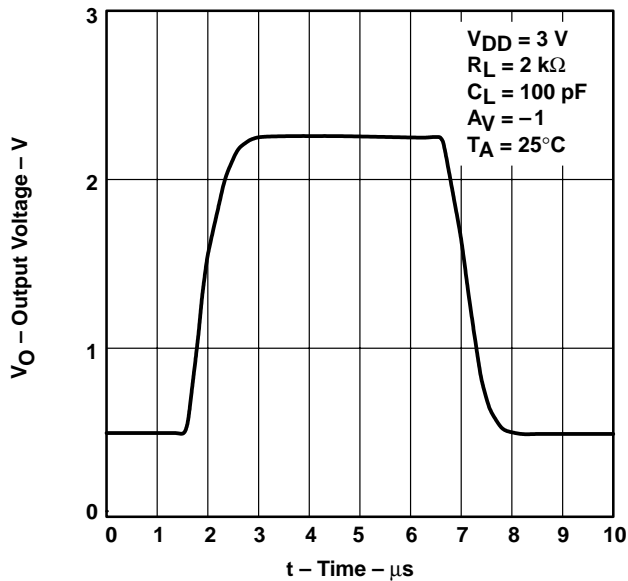

Figure 33

INVERTING LARGE-SIGNAL PULSE RESPONSE

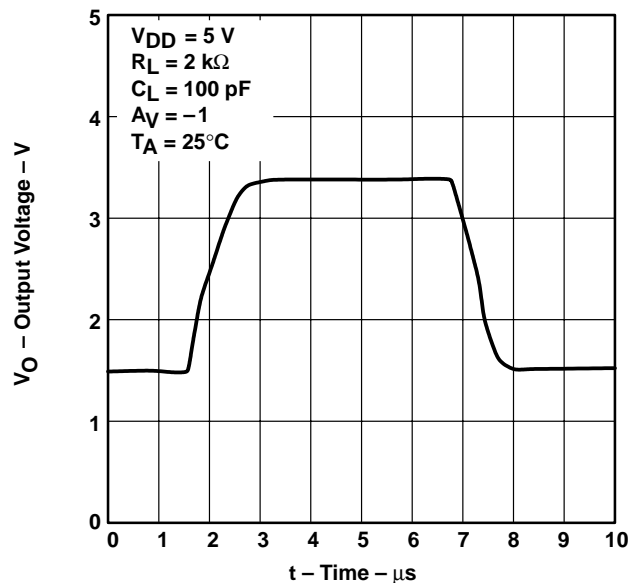

Figure 34



TYPICAL CHARACTERISTICS

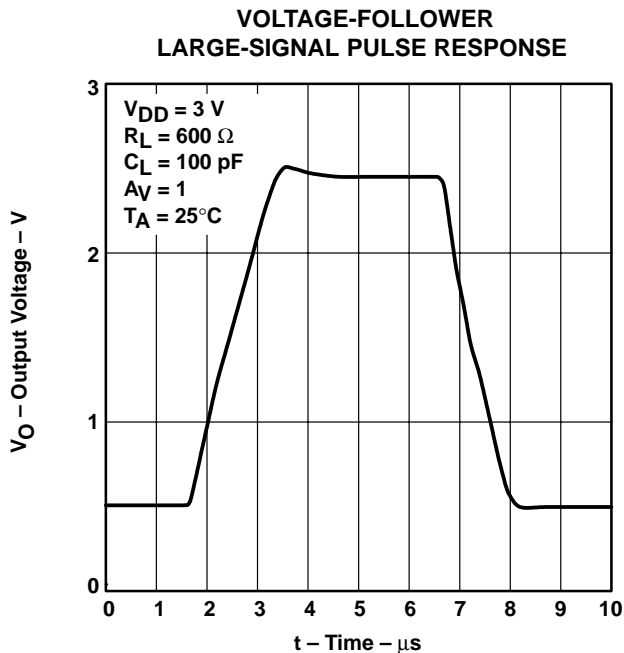

Figure 35



Figure 36

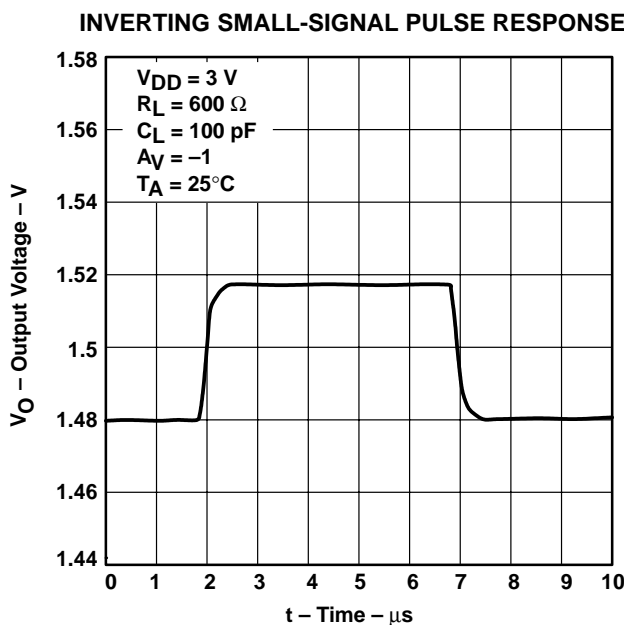

Figure 37

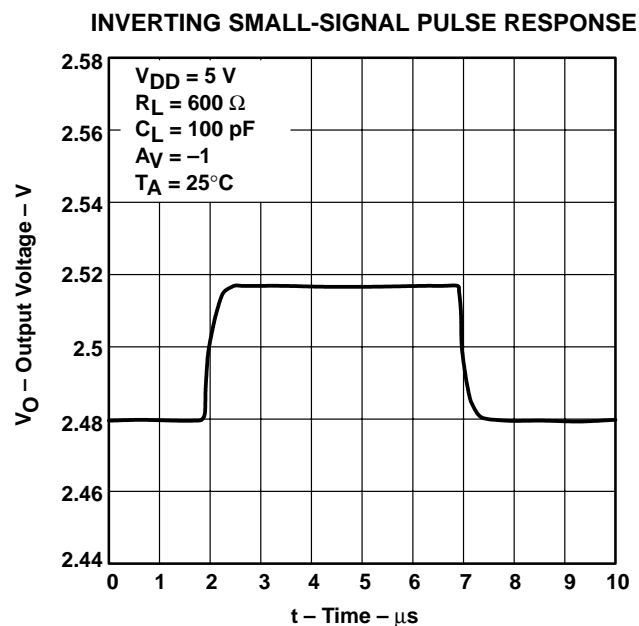

Figure 38

TLV2442, TLV2442A, TLV2444, TLV2444A
Advanced LinCMOS™ RAIL-TO-RAIL OUTPUT
WIDE-INPUT-VOLTAGE OPERATIONAL AMPLIFIERS

SLOS169H – NOVEMBER 1996 – REVISED MARCH 2001

TYPICAL CHARACTERISTICS

**VOLTAGE-FOLLOWER
 SMALL-SIGNAL PULSE RESPONSE**

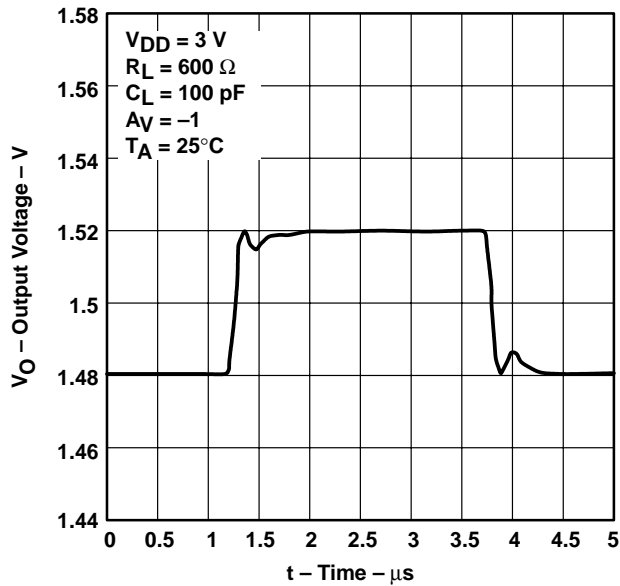

Figure 39

**VOLTAGE-FOLLOWER
 SMALL-SIGNAL PULSE RESPONSE**

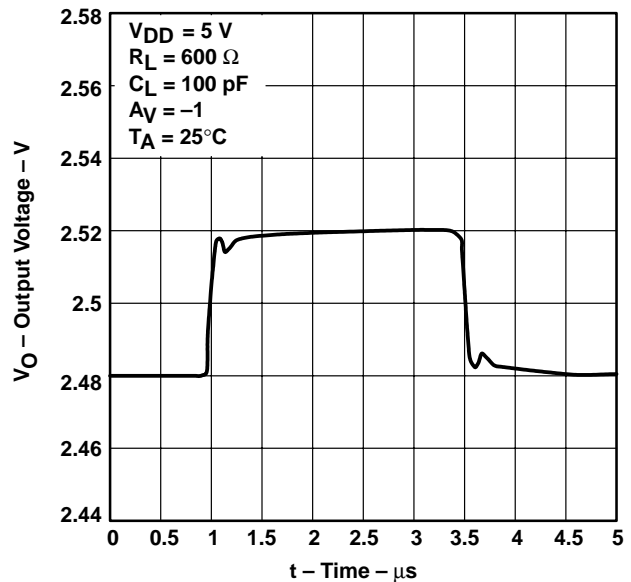

Figure 40

**EQUIVALENT INPUT NOISE VOLTAGE
 VS
 FREQUENCY**

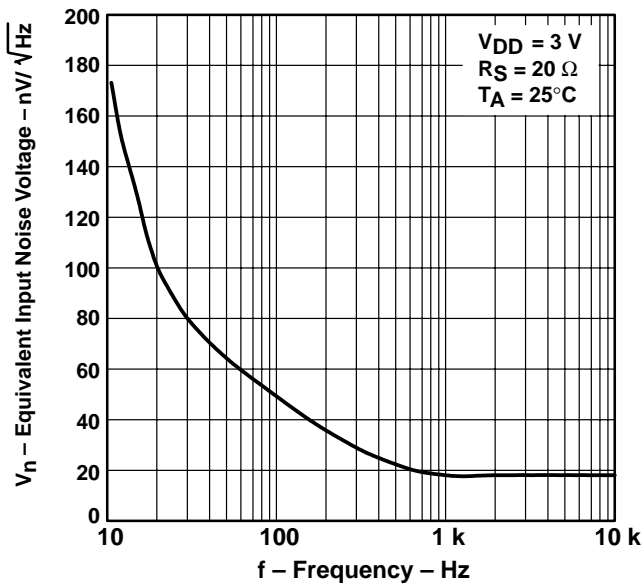

Figure 41

**EQUIVALENT INPUT NOISE VOLTAGE
 VS
 FREQUENCY**

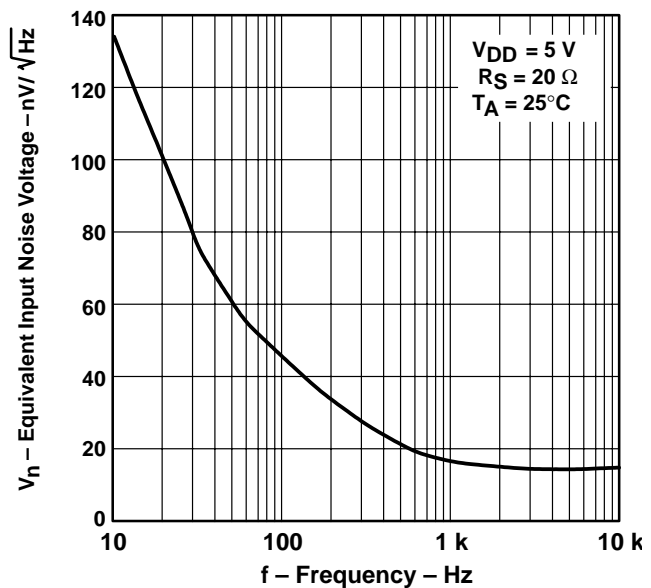

Figure 42



TYPICAL CHARACTERISTICS

NOISE VOLTAGE
 OVER A 10-SECOND PERIOD



Figure 43

TOTAL HARMONIC DISTORTION PLUS NOISE
 vs
 FREQUENCY



Figure 44

TOTAL HARMONIC DISTORTION PLUS NOISE
 vs
 FREQUENCY



Figure 45

GAIN-BANDWIDTH PRODUCT
 vs
 FREE-AIR TEMPERATURE

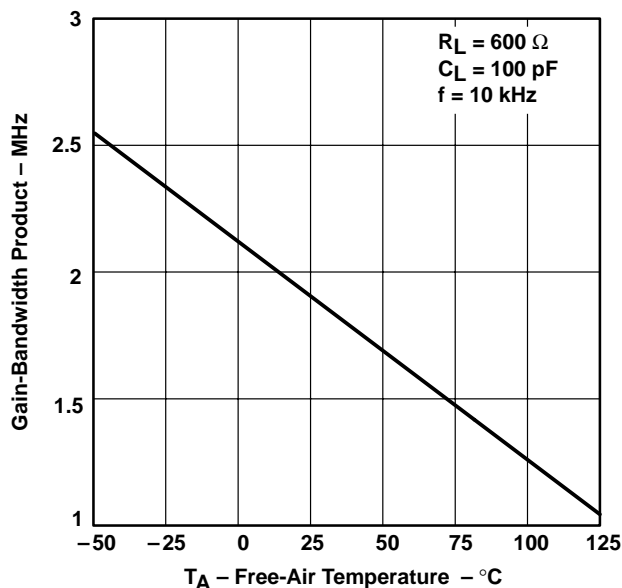

Figure 46

TLV2442, TLV2442A, TLV2444, TLV2444A
Advanced LinCMOS™ RAIL-TO-RAIL OUTPUT
WIDE-INPUT-VOLTAGE OPERATIONAL AMPLIFIERS

SLOS169H – NOVEMBER 1996 – REVISED MARCH 2001

TYPICAL CHARACTERISTICS

GAIN-BANDWIDTH PRODUCT
vs
SUPPLY VOLTAGE

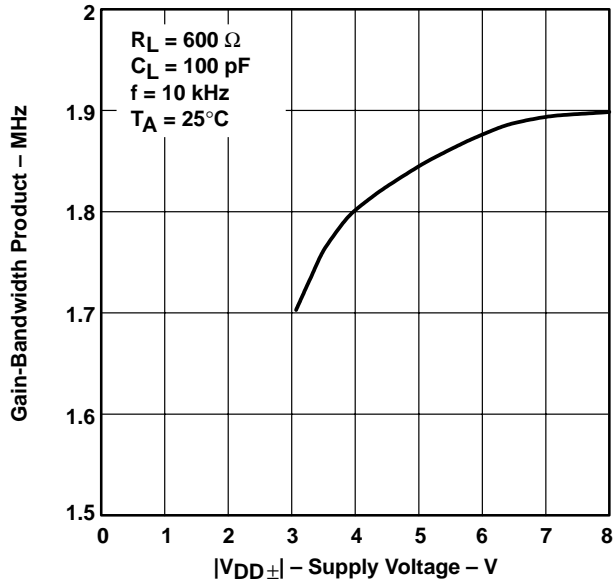

Figure 47

PHASE MARGIN
vs
LOAD CAPACITANCE

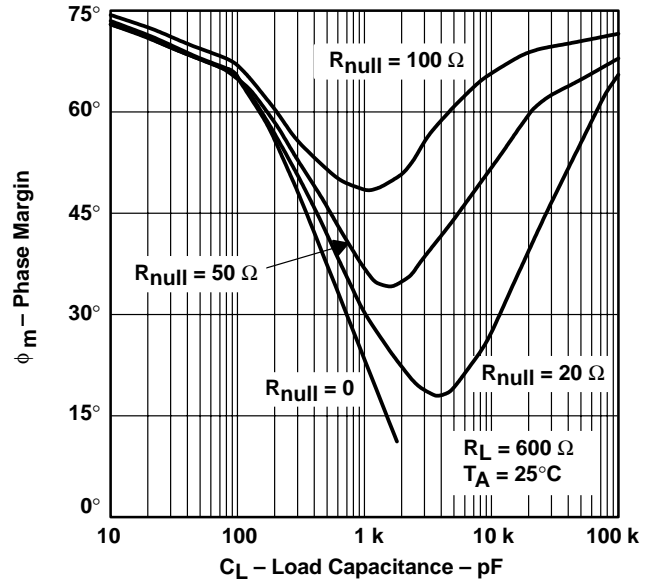

Figure 48

GAIN MARGIN
vs
LOAD CAPACITANCE

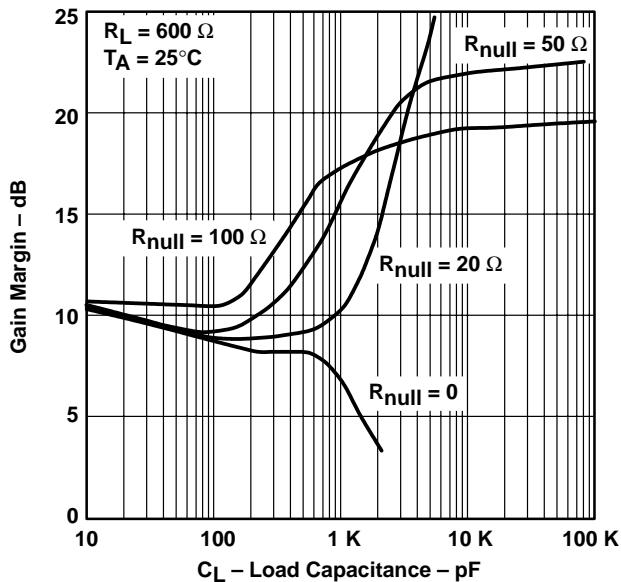

Figure 49

UNITY-GAIN BANDWIDTH
vs
LOAD CAPACITANCE

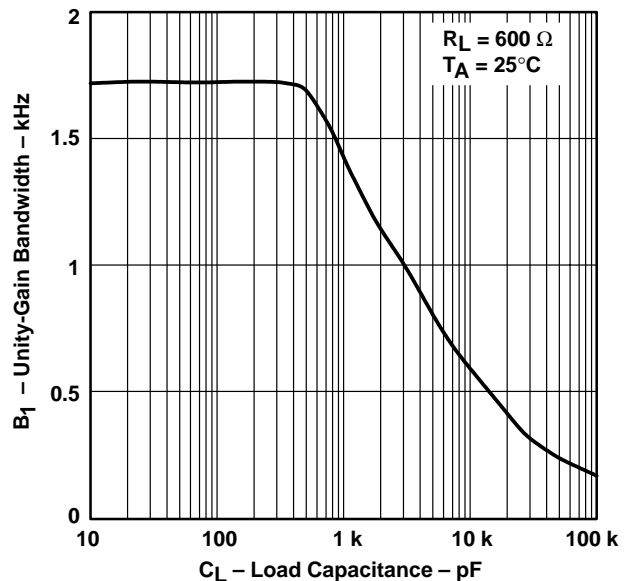

Figure 50



TLV2442, TLV2442A, TLV2444, TLV2444A Advanced LinCMOS™ RAIL-TO-RAIL OUTPUT WIDE-INPUT-VOLTAGE OPERATIONAL AMPLIFIERS

SLOS169H – NOVEMBER 1996 – REVISED MARCH 2001

APPLICATION INFORMATION

macromodel information

Macromodel information provided was derived using *PSpice™ Parts™* model generation software. The Boyle macromodel (see Note 5) and subcircuit in Figure 51 were generated using the TLV244x typical electrical and operating characteristics at $T_A = 25^\circ\text{C}$. Using this information, output simulations of the following key parameters can be generated to a tolerance of 20% (in most cases):

- Maximum positive output voltage swing
- Maximum negative output voltage swing
- Slew rate
- Quiescent power dissipation
- Input bias current
- Open-loop voltage amplification
- Unity gain frequency
- Common-mode rejection ratio
- Phase margin
- DC output resistance
- AC output resistance
- Short-circuit output current limit

NOTE 5: G. R. Boyle, B. M. Cohn, D. O. Pederson, and J. E. Solomon, "Macromodeling of Integrated Circuit Operational Amplifiers," *IEEE Journal of Solid-State Circuits*, SC-9, 353 (1974).

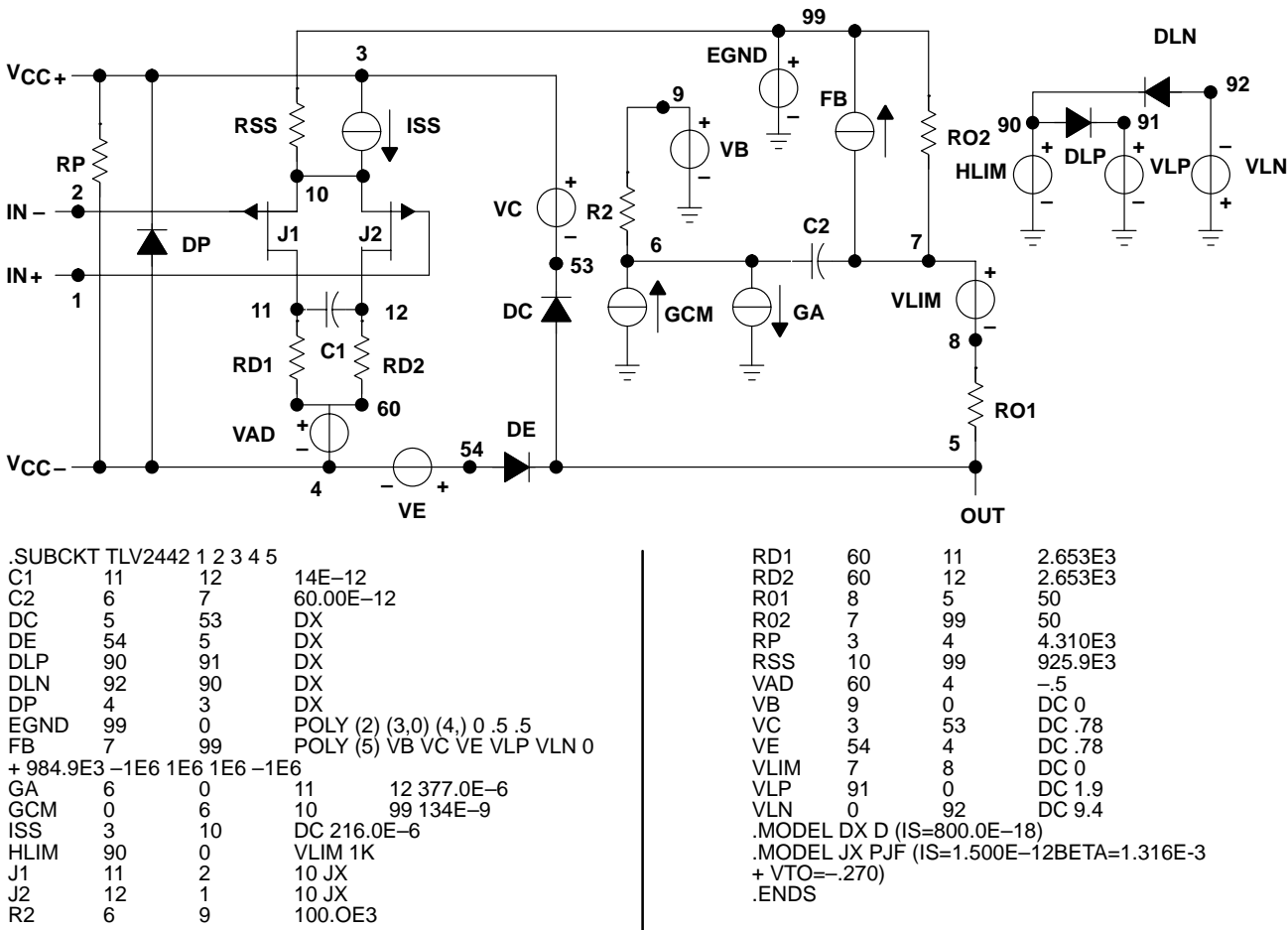

Figure 51. Boyle Macromodel and Subcircuit

PSpice and *Parts* are registered trademarks of MicroSim Corporation.



TLV2442, TLV2442A, TLV2444, TLV2444A
Advanced LinCMOS™ RAIL-TO-RAIL OUTPUT
WIDE-INPUT-VOLTAGE OPERATIONAL AMPLIFIERS

SLOS169H – NOVEMBER 1996 – REVISED MARCH 2001

MECHANICAL DATA

D (R-PDSO-G)**

PLASTIC SMALL-OUTLINE PACKAGE

14 PIN SHOWN

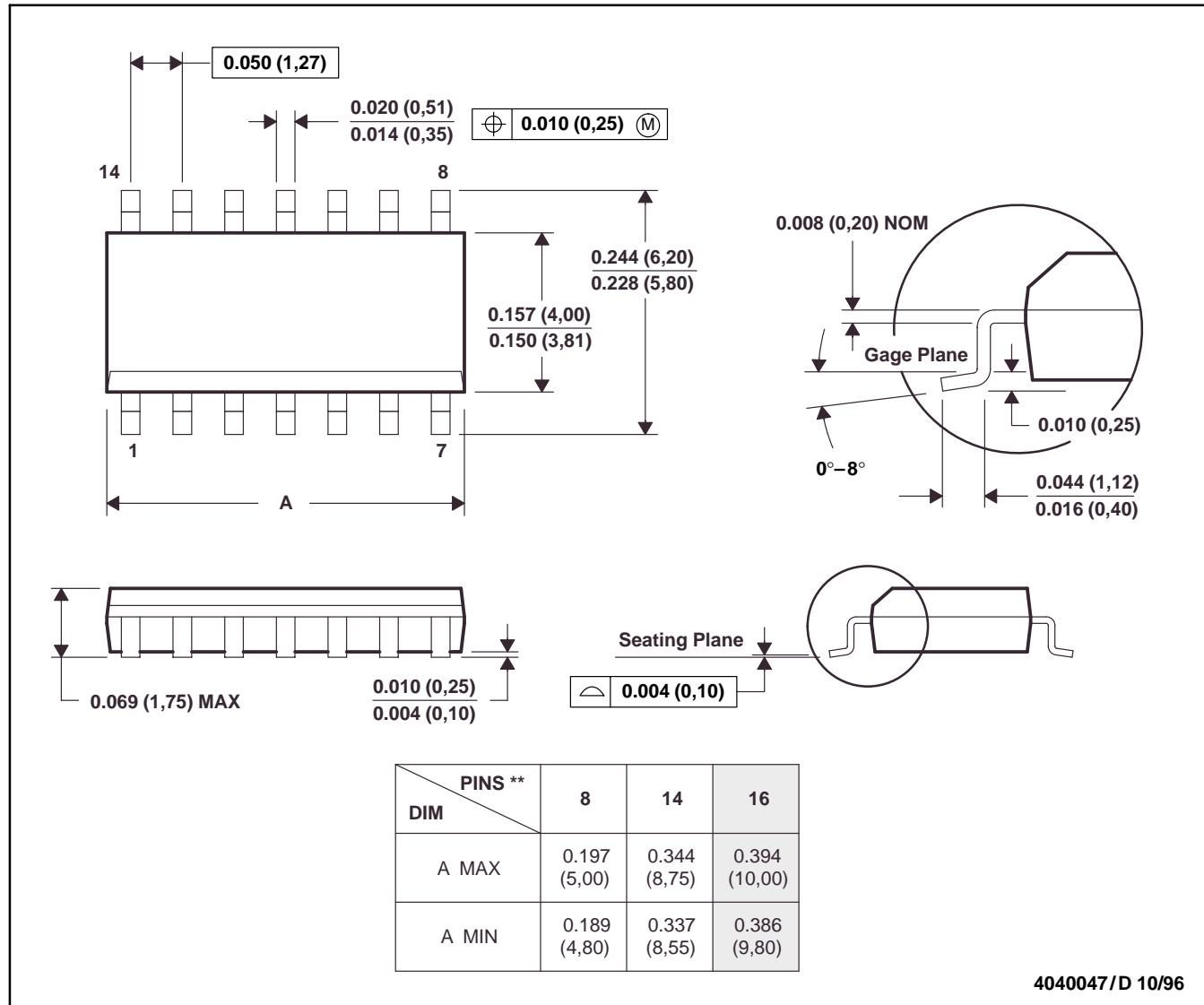

- NOTES: A. All linear dimensions are in inches (millimeters).
 B. This drawing is subject to change without notice.
 C. Body dimensions do not include mold flash or protrusion, not to exceed 0.006 (0,15).
 D. Falls within JEDEC MS-012

TLV2442, TLV2442A, TLV2444, TLV2444A
Advanced LinCMOS™ RAIL-TO-RAIL OUTPUT
WIDE-INPUT-VOLTAGE OPERATIONAL AMPLIFIERS

SLOS169H – NOVEMBER 1996 – REVISED MARCH 2001

MECHANICAL DATA

FK (S-CQCC-N)**

LEADLESS CERAMIC CHIP CARRIER

28 TERMINAL SHOWN



- NOTES: A. All linear dimensions are in inches (millimeters).
 B. This drawing is subject to change without notice.
 C. This package can be hermetically sealed with a metal lid.
 D. The terminals are gold plated.
 E. Falls within JEDEC MS-004

TLV2442, TLV2442A, TLV2444, TLV2444A
Advanced LinCMOS™ RAIL-TO-RAIL OUTPUT
WIDE-INPUT-VOLTAGE OPERATIONAL AMPLIFIERS

SLOS169H – NOVEMBER 1996 – REVISED MARCH 2001

MECHANICAL DATA

JG (R-GDIP-T8)

CERAMIC DUAL-IN-LINE PACKAGE

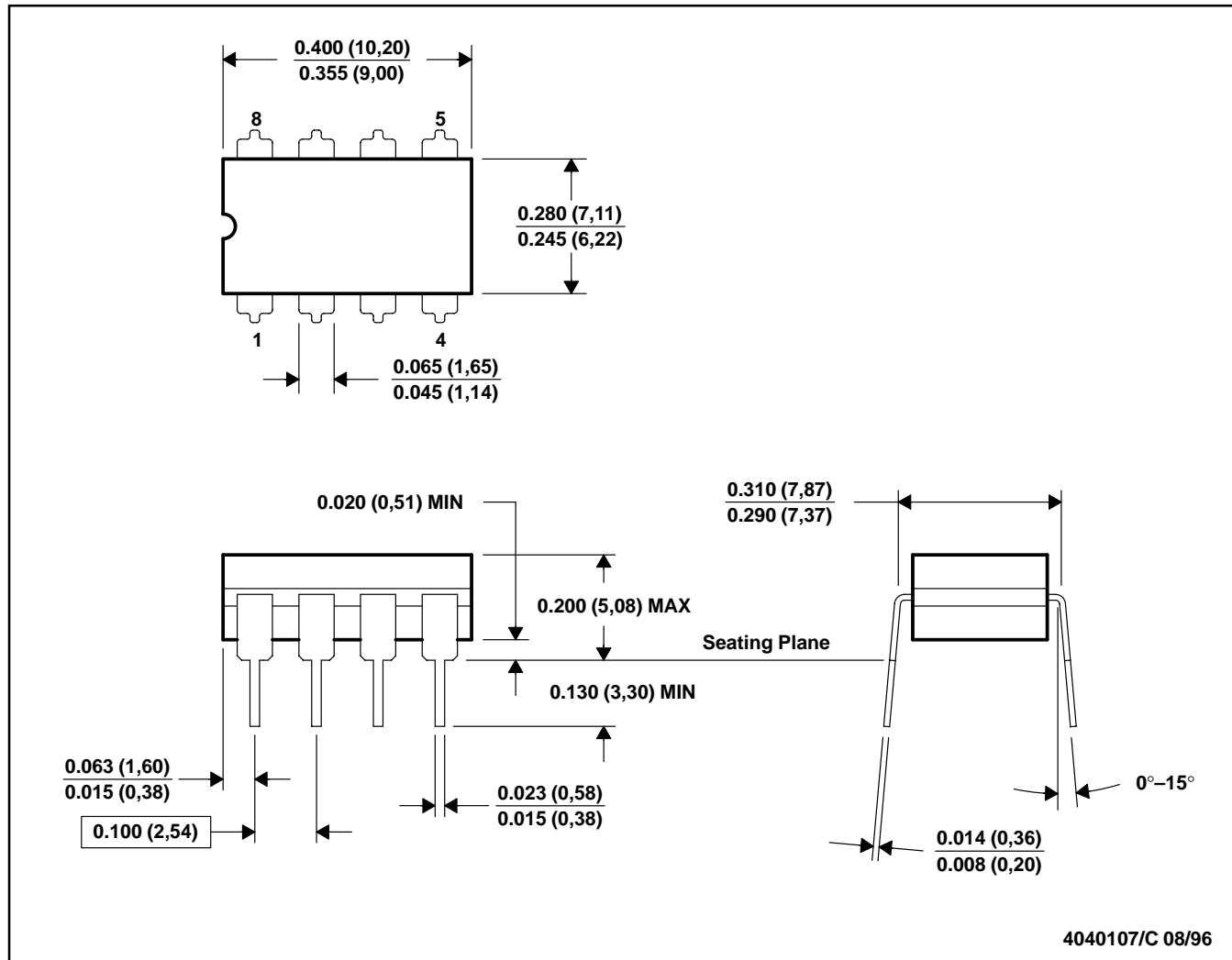

- NOTES: A. All linear dimensions are in inches (millimeters).
 B. This drawing is subject to change without notice.
 C. This package can be hermetically sealed with a ceramic lid using glass frit.
 D. Index point is provided on cap for terminal identification on press ceramic glass frit seal only.
 E. Falls within MIL-STD-1835 GDIP1-T8



POST OFFICE BOX 655303 • DALLAS, TEXAS 75265

TLV2442, TLV2442A, TLV2444, TLV2444A
 Advanced LinCMOS™ RAIL-TO-RAIL OUTPUT
 WIDE-INPUT-VOLTAGE OPERATIONAL AMPLIFIERS

SLOS169H – NOVEMBER 1996 – REVISED MARCH 2001

MECHANICAL DATA

PW (R-PDSO-G**)

PLASTIC SMALL-OUTLINE PACKAGE

14 PIN SHOWN

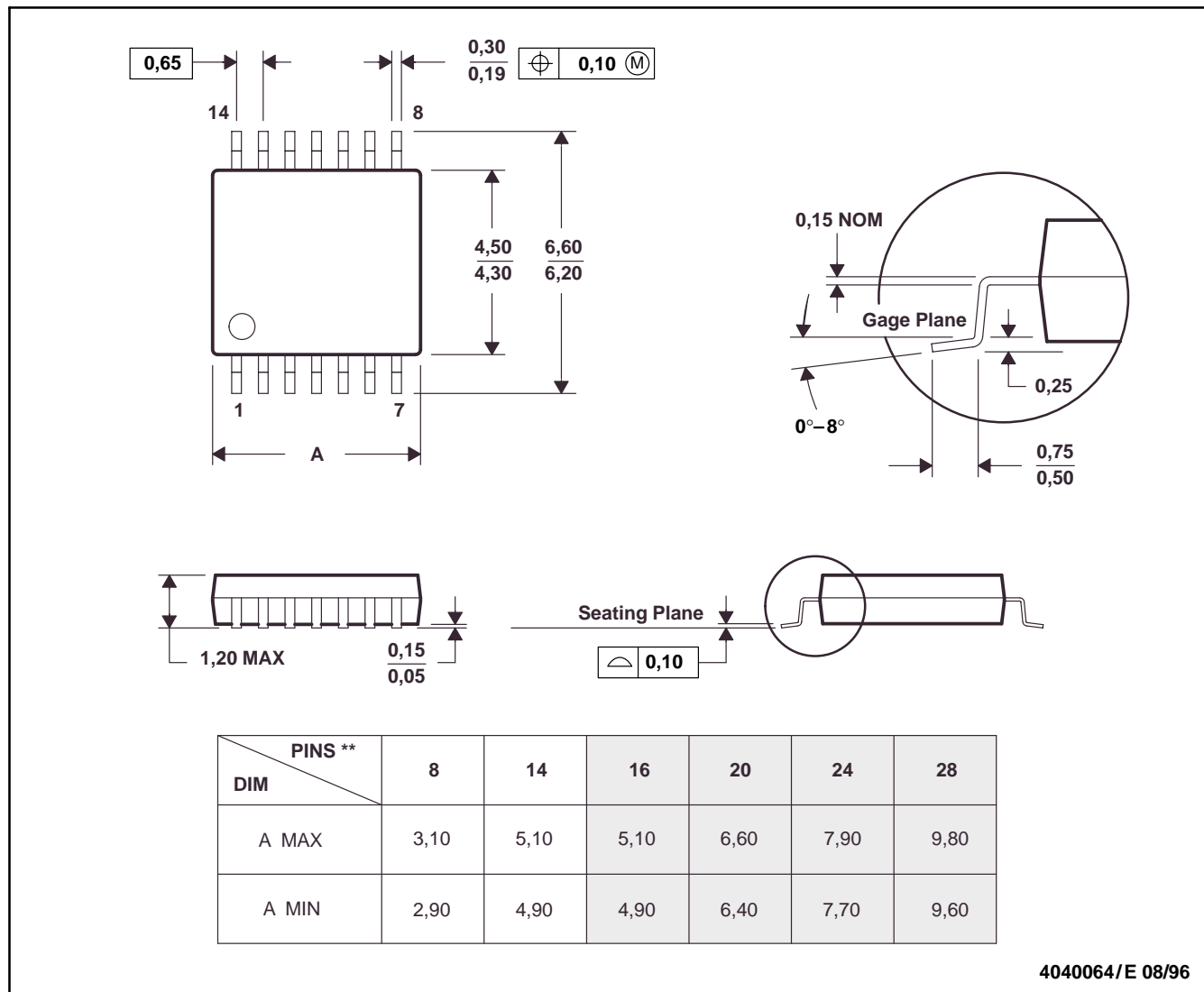

4040064/E 08/96

- NOTES: A. All linear dimensions are in millimeters.
 B. This drawing is subject to change without notice.
 C. Body dimensions do not include mold flash or protrusion not to exceed 0,15.
 D. Falls within JEDEC MO-153

TLV2442, TLV2442A, TLV2444, TLV2444A
Advanced LinCMOS™ RAIL-TO-RAIL OUTPUT
WIDE-INPUT-VOLTAGE OPERATIONAL AMPLIFIERS

SLOS169H – NOVEMBER 1996 – REVISED MARCH 2001

MECHANICAL DATA

U (S-GDFP-F10)

CERAMIC DUAL FLATPACK

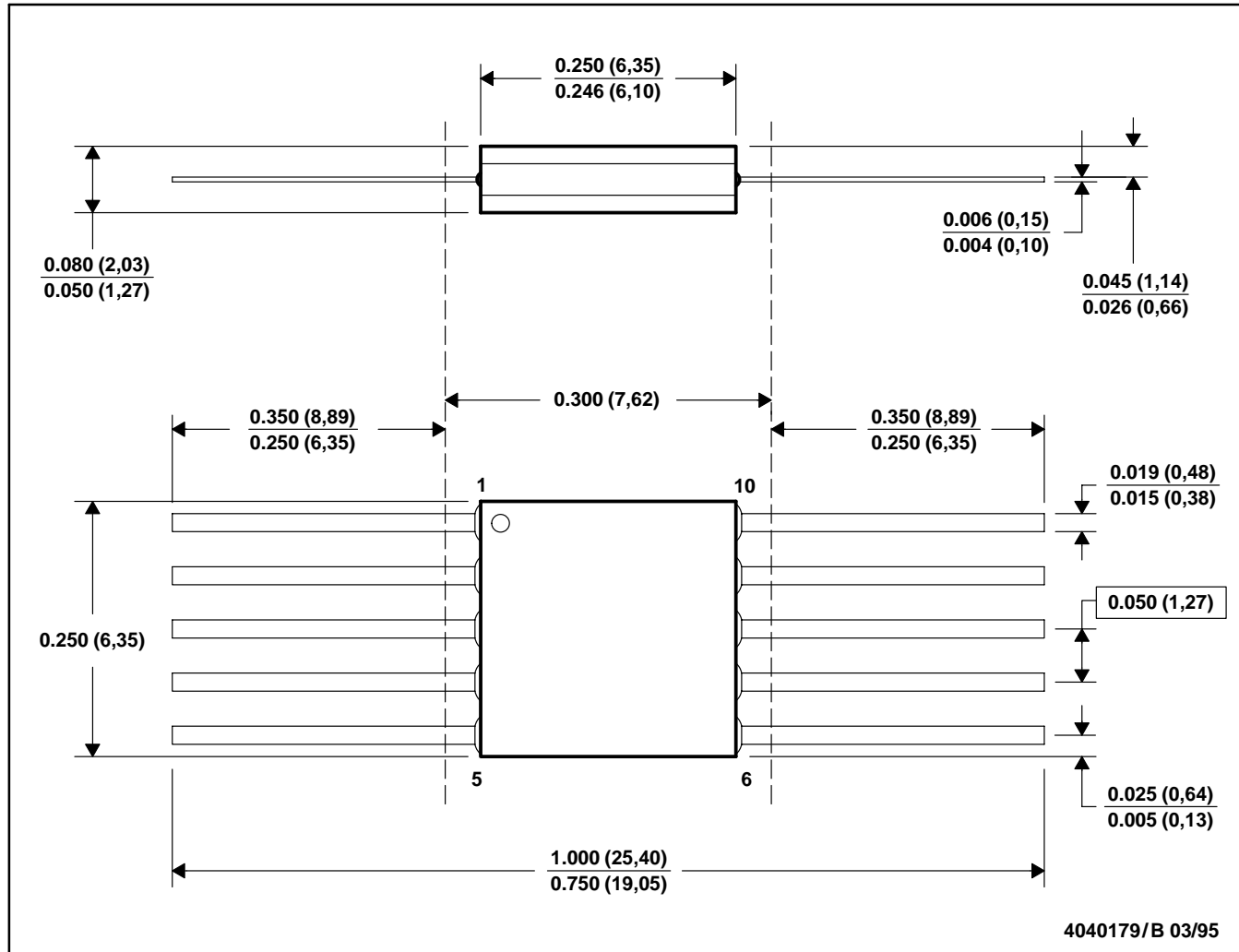

- NOTES: A. All linear dimensions are in inches (millimeters).
 B. This drawing is subject to change without notice.
 C. This package can be hermetically sealed with a ceramic lid using glass frit.
 D. Index point is provided on cap for terminal identification only.
 E. Falls within MIL STD 1835 GDFP1-F10 and JEDEC MO-092AA



POST OFFICE BOX 655303 • DALLAS, TEXAS 75265

PACKAGING INFORMATION

Orderable part number	Status (1)	Material type (2)	Package Pins	Package qty Carrier	RoHS (3)	Lead finish/ Ball material (4)	MSL rating/ Peak reflow (5)	Op temp (°C)	Part marking (6)
TLV2442AID	Active	Production	SOIC (D) 8	75 TUBE	Yes	NIPDAU	Level-1-260C-UNLIM	-40 to 85	2442AI
TLV2442AID.A	Active	Production	SOIC (D) 8	75 TUBE	Yes	NIPDAU	Level-1-260C-UNLIM	-40 to 125	2442AI
TLV2442AIDR	Active	Production	SOIC (D) 8	2500 LARGE T&R	Yes	NIPDAU	Level-1-260C-UNLIM	-40 to 85	2442AI
TLV2442AIDR.A	Active	Production	SOIC (D) 8	2500 LARGE T&R	Yes	NIPDAU	Level-1-260C-UNLIM	-40 to 125	2442AI
TLV2442AIPW	Active	Production	TSSOP (PW) 8	150 TUBE	Yes	NIPDAU	Level-1-260C-UNLIM	-40 to 85	TV2442
TLV2442AIPW.A	Active	Production	TSSOP (PW) 8	150 TUBE	Yes	NIPDAU	Level-1-260C-UNLIM	-40 to 125	TV2442
TLV2442AIPWR	Active	Production	TSSOP (PW) 8	2000 LARGE T&R	Yes	NIPDAU	Level-1-260C-UNLIM	-40 to 85	2442AI
TLV2442AIPWR.A	Active	Production	TSSOP (PW) 8	2000 LARGE T&R	Yes	NIPDAU	Level-1-260C-UNLIM	-40 to 125	2442AI
TLV2442AQD	Active	Production	SOIC (D) 8	75 TUBE	Yes	NIPDAU	Level-1-260C-UNLIM	-40 to 125	V2442A
TLV2442AQD.A	Active	Production	SOIC (D) 8	75 TUBE	Yes	NIPDAU	Level-1-260C-UNLIM	-40 to 125	V2442A
TLV2442AQPW	Active	Production	TSSOP (PW) 8	150 TUBE	Yes	NIPDAU	Level-1-260C-UNLIM	-40 to 125	2442AQ
TLV2442AQPW.A	Active	Production	TSSOP (PW) 8	150 TUBE	Yes	NIPDAU	Level-1-260C-UNLIM	-40 to 125	2442AQ
TLV2442AQPWR	Active	Production	TSSOP (PW) 8	2000 LARGE T&R	Yes	NIPDAU	Level-1-260C-UNLIM	-40 to 125	2442AQ
TLV2442AQPWR.A	Active	Production	TSSOP (PW) 8	2000 LARGE T&R	Yes	NIPDAU	Level-1-260C-UNLIM	-40 to 125	2442AQ
TLV2442CD	Active	Production	SOIC (D) 8	75 TUBE	Yes	NIPDAU	Level-1-260C-UNLIM	0 to 70	2442C
TLV2442CD.A	Active	Production	SOIC (D) 8	75 TUBE	Yes	NIPDAU	Level-1-260C-UNLIM	-40 to 125	2442C
TLV2442CDR	Active	Production	SOIC (D) 8	2500 LARGE T&R	Yes	NIPDAU	Level-1-260C-UNLIM	0 to 70	2442C
TLV2442CDR.A	Active	Production	SOIC (D) 8	2500 LARGE T&R	Yes	NIPDAU	Level-1-260C-UNLIM	-40 to 125	2442C
TLV2442CPW	Active	Production	TSSOP (PW) 8	150 TUBE	Yes	NIPDAU	Level-1-260C-UNLIM	0 to 70	TV2442
TLV2442CPW.A	Active	Production	TSSOP (PW) 8	150 TUBE	Yes	NIPDAU	Level-1-260C-UNLIM	-40 to 125	TV2442
TLV2442ID	Active	Production	SOIC (D) 8	75 TUBE	Yes	NIPDAU	Level-1-260C-UNLIM	-40 to 85	2442I
TLV2442ID.A	Active	Production	SOIC (D) 8	75 TUBE	Yes	NIPDAU	Level-1-260C-UNLIM	-40 to 125	2442I
TLV2442IDR	Active	Production	SOIC (D) 8	2500 LARGE T&R	Yes	NIPDAU	Level-1-260C-UNLIM	-40 to 85	2442I
TLV2442IDR.A	Active	Production	SOIC (D) 8	2500 LARGE T&R	Yes	NIPDAU	Level-1-260C-UNLIM	-40 to 125	2442I
TLV2442QPW	Active	Production	TSSOP (PW) 8	150 TUBE	Yes	NIPDAU	Level-1-260C-UNLIM	-40 to 125	2442Q
TLV2442QPW.A	Active	Production	TSSOP (PW) 8	150 TUBE	Yes	NIPDAU	Level-1-260C-UNLIM	-40 to 125	2442Q
TLV2442QPWR	Active	Production	TSSOP (PW) 8	2000 LARGE T&R	Yes	NIPDAU	Level-1-260C-UNLIM	-40 to 125	2442Q
TLV2442QPWR.A	Active	Production	TSSOP (PW) 8	2000 LARGE T&R	Yes	NIPDAU	Level-1-260C-UNLIM	-40 to 125	2442Q
TLV2444AID	Active	Production	SOIC (D) 14	50 TUBE	Yes	NIPDAU	Level-1-260C-UNLIM	-40 to 125	2444AI

Orderable part number	Status (1)	Material type (2)	Package Pins	Package qty Carrier	RoHS (3)	Lead finish/ Ball material (4)	MSL rating/ Peak reflow (5)	Op temp (°C)	Part marking (6)
TLV2444AID.A	Active	Production	SOIC (D) 14	50 TUBE	Yes	NIPDAU	Level-1-260C-UNLIM	-40 to 125	2444AI
TLV2444AIPW	Active	Production	TSSOP (PW) 14	90 TUBE	Yes	NIPDAU	Level-1-260C-UNLIM	-40 to 125	2444AI
TLV2444AIPW.A	Active	Production	TSSOP (PW) 14	90 TUBE	Yes	NIPDAU	Level-1-260C-UNLIM	-40 to 125	2444AI
TLV2444AIPWR	Active	Production	TSSOP (PW) 14	2000 LARGE T&R	Yes	NIPDAU	Level-1-260C-UNLIM	-40 to 125	2444AI
TLV2444AIPWR.A	Active	Production	TSSOP (PW) 14	2000 LARGE T&R	Yes	NIPDAU	Level-1-260C-UNLIM	-40 to 125	2444AI
TLV2444CD	Active	Production	SOIC (D) 14	50 TUBE	Yes	NIPDAU	Level-1-260C-UNLIM	0 to 70	2444C
TLV2444CD.A	Active	Production	SOIC (D) 14	50 TUBE	Yes	NIPDAU	Level-1-260C-UNLIM	-40 to 125	2444C
TLV2444CDR	Active	Production	SOIC (D) 14	2500 LARGE T&R	Yes	NIPDAU	Level-1-260C-UNLIM	0 to 70	2444C
TLV2444CDR.A	Active	Production	SOIC (D) 14	2500 LARGE T&R	Yes	NIPDAU	Level-1-260C-UNLIM	-40 to 125	2444C
TLV2444CPW	Active	Production	TSSOP (PW) 14	90 TUBE	Yes	NIPDAU	Level-1-260C-UNLIM	0 to 70	2444C
TLV2444CPW.A	Active	Production	TSSOP (PW) 14	90 TUBE	Yes	NIPDAU	Level-1-260C-UNLIM	-40 to 125	2444C
TLV2444CPWR	Active	Production	TSSOP (PW) 14	2000 LARGE T&R	Yes	NIPDAU	Level-1-260C-UNLIM	0 to 70	2444C
TLV2444CPWR.A	Active	Production	TSSOP (PW) 14	2000 LARGE T&R	Yes	NIPDAU	Level-1-260C-UNLIM	-40 to 125	2444C
TLV2444ID	Active	Production	SOIC (D) 14	50 TUBE	Yes	NIPDAU	Level-1-260C-UNLIM	-40 to 125	2444I
TLV2444ID.A	Active	Production	SOIC (D) 14	50 TUBE	Yes	NIPDAU	Level-1-260C-UNLIM	-40 to 125	2444I
TLV2444IDR	Active	Production	SOIC (D) 14	2500 LARGE T&R	Yes	NIPDAU	Level-1-260C-UNLIM	-40 to 125	2444I
TLV2444IDR.A	Active	Production	SOIC (D) 14	2500 LARGE T&R	Yes	NIPDAU	Level-1-260C-UNLIM	-40 to 125	2444I
TLV2444IPWR	Active	Production	TSSOP (PW) 14	2000 LARGE T&R	Yes	NIPDAU	Level-1-260C-UNLIM	-40 to 125	2444I
TLV2444IPWR.A	Active	Production	TSSOP (PW) 14	2000 LARGE T&R	Yes	NIPDAU	Level-1-260C-UNLIM	-40 to 125	2444I

(1) **Status:** For more details on status, see our [product life cycle](#).

(2) **Material type:** When designated, preproduction parts are prototypes/experimental devices, and are not yet approved or released for full production. Testing and final process, including without limitation quality assurance, reliability performance testing, and/or process qualification, may not yet be complete, and this item is subject to further changes or possible discontinuation. If available for ordering, purchases will be subject to an additional waiver at checkout, and are intended for early internal evaluation purposes only. These items are sold without warranties of any kind.

(3) **RoHS values:** Yes, No, RoHS Exempt. See the [TI RoHS Statement](#) for additional information and value definition.

(4) **Lead finish/Ball material:** Parts may have multiple material finish options. Finish options are separated by a vertical ruled line. Lead finish/Ball material values may wrap to two lines if the finish value exceeds the maximum column width.

(5) **MSL rating/Peak reflow:** The moisture sensitivity level ratings and peak solder (reflow) temperatures. In the event that a part has multiple moisture sensitivity ratings, only the lowest level per JEDEC standards is shown. Refer to the shipping label for the actual reflow temperature that will be used to mount the part to the printed circuit board.

(6) **Part marking:** There may be an additional marking, which relates to the logo, the lot trace code information, or the environmental category of the part.

Multiple part markings will be inside parentheses. Only one part marking contained in parentheses and separated by a "~" will appear on a part. If a line is indented then it is a continuation of the previous line and the two combined represent the entire part marking for that device.

Important Information and Disclaimer:The information provided on this page represents TI's knowledge and belief as of the date that it is provided. TI bases its knowledge and belief on information provided by third parties, and makes no representation or warranty as to the accuracy of such information. Efforts are underway to better integrate information from third parties. TI has taken and continues to take reasonable steps to provide representative and accurate information but may not have conducted destructive testing or chemical analysis on incoming materials and chemicals. TI and TI suppliers consider certain information to be proprietary, and thus CAS numbers and other limited information may not be available for release.

In no event shall TI's liability arising out of such information exceed the total purchase price of the TI part(s) at issue in this document sold by TI to Customer on an annual basis.

OTHER QUALIFIED VERSIONS OF TLV2442, TLV2442A :

- Automotive : [TLV2442-Q1](#), [TLV2442A-Q1](#)

NOTE: Qualified Version Definitions:

- Automotive - Q100 devices qualified for high-reliability automotive applications targeting zero defects

TAPE AND REEL INFORMATION

QUADRANT ASSIGNMENTS FOR PIN 1 ORIENTATION IN TAPE

*All dimensions are nominal

Device	Package Type	Package Drawing	Pins	SPQ	Reel Diameter (mm)	Reel Width W1 (mm)	A0 (mm)	B0 (mm)	K0 (mm)	P1 (mm)	W (mm)	Pin1 Quadrant
TLV2442AIDR	SOIC	D	8	2500	330.0	12.4	6.4	5.2	2.1	8.0	12.0	Q1
TLV2442AIPWR	TSSOP	PW	8	2000	330.0	12.4	7.0	3.6	1.6	8.0	12.0	Q1
TLV2442AQPWR	TSSOP	PW	8	2000	330.0	12.4	7.0	3.6	1.6	8.0	12.0	Q1
TLV2442CDR	SOIC	D	8	2500	330.0	12.4	6.4	5.2	2.1	8.0	12.0	Q1
TLV2442IDR	SOIC	D	8	2500	330.0	12.4	6.4	5.2	2.1	8.0	12.0	Q1
TLV2442QPWR	TSSOP	PW	8	2000	330.0	12.4	7.0	3.6	1.6	8.0	12.0	Q1
TLV2444AIPWR	TSSOP	PW	14	2000	330.0	12.4	6.9	5.6	1.6	8.0	12.0	Q1
TLV2444CDR	SOIC	D	14	2500	330.0	16.4	6.5	9.0	2.1	8.0	16.0	Q1
TLV2444CPWR	TSSOP	PW	14	2000	330.0	12.4	6.9	5.6	1.6	8.0	12.0	Q1
TLV2444IDR	SOIC	D	14	2500	330.0	16.4	6.5	9.0	2.1	8.0	16.0	Q1
TLV2444IPWR	TSSOP	PW	14	2000	330.0	12.4	6.9	5.6	1.6	8.0	12.0	Q1

TAPE AND REEL BOX DIMENSIONS

*All dimensions are nominal

Device	Package Type	Package Drawing	Pins	SPQ	Length (mm)	Width (mm)	Height (mm)
TLV2442AIDR	SOIC	D	8	2500	353.0	353.0	32.0
TLV2442AIPWR	TSSOP	PW	8	2000	356.0	356.0	35.0
TLV2442AQPWR	TSSOP	PW	8	2000	356.0	356.0	35.0
TLV2442CDR	SOIC	D	8	2500	353.0	353.0	32.0
TLV2442IDR	SOIC	D	8	2500	353.0	353.0	32.0
TLV2442QPWR	TSSOP	PW	8	2000	356.0	356.0	35.0
TLV2444AIPWR	TSSOP	PW	14	2000	356.0	356.0	35.0
TLV2444CDR	SOIC	D	14	2500	350.0	350.0	43.0
TLV2444CPWR	TSSOP	PW	14	2000	356.0	356.0	35.0
TLV2444IDR	SOIC	D	14	2500	350.0	350.0	43.0
TLV2444IPWR	TSSOP	PW	14	2000	356.0	356.0	35.0

TUBE

*All dimensions are nominal

Device	Package Name	Package Type	Pins	SPQ	L (mm)	W (mm)	T (μm)	B (mm)
TLV2442AID	D	SOIC	8	75	507	8	3940	4.32
TLV2442AID	D	SOIC	8	75	505.46	6.76	3810	4
TLV2442AID.A	D	SOIC	8	75	505.46	6.76	3810	4
TLV2442AID.A	D	SOIC	8	75	507	8	3940	4.32
TLV2442AIPW	PW	TSSOP	8	150	530	10.2	3600	3.5
TLV2442AIPW.A	PW	TSSOP	8	150	530	10.2	3600	3.5
TLV2442AQD	D	SOIC	8	75	507	8	3940	4.32
TLV2442AQD.A	D	SOIC	8	75	507	8	3940	4.32
TLV2442AQPW	PW	TSSOP	8	150	530	10.2	3600	3.5
TLV2442AQPW.A	PW	TSSOP	8	150	530	10.2	3600	3.5
TLV2442CD	D	SOIC	8	75	507	8	3940	4.32
TLV2442CD	D	SOIC	8	75	505.46	6.76	3810	4
TLV2442CD.A	D	SOIC	8	75	505.46	6.76	3810	4
TLV2442CD.A	D	SOIC	8	75	507	8	3940	4.32
TLV2442CPW	PW	TSSOP	8	150	530	10.2	3600	3.5
TLV2442CPW.A	PW	TSSOP	8	150	530	10.2	3600	3.5
TLV2442ID	D	SOIC	8	75	505.46	6.76	3810	4
TLV2442ID	D	SOIC	8	75	507	8	3940	4.32
TLV2442ID.A	D	SOIC	8	75	505.46	6.76	3810	4
TLV2442ID.A	D	SOIC	8	75	507	8	3940	4.32
TLV2442QPW	PW	TSSOP	8	150	530	10.2	3600	3.5
TLV2442QPW.A	PW	TSSOP	8	150	530	10.2	3600	3.5
TLV2444AID	D	SOIC	14	50	505.46	6.76	3810	4
TLV2444AID.A	D	SOIC	14	50	505.46	6.76	3810	4
TLV2444AIPW	PW	TSSOP	14	90	530	10.2	3600	3.5
TLV2444AIPW.A	PW	TSSOP	14	90	530	10.2	3600	3.5
TLV2444CD	D	SOIC	14	50	505.46	6.76	3810	4
TLV2444CD.A	D	SOIC	14	50	505.46	6.76	3810	4
TLV2444CPW	PW	TSSOP	14	90	530	10.2	3600	3.5

Device	Package Name	Package Type	Pins	SPQ	L (mm)	W (mm)	T (μm)	B (mm)
TLV2444CPW.A	PW	TSSOP	14	90	530	10.2	3600	3.5
TLV2444ID	D	SOIC	14	50	505.46	6.76	3810	4
TLV2444ID.A	D	SOIC	14	50	505.46	6.76	3810	4



D0014A

PACKAGE OUTLINE

SOIC - 1.75 mm max height

SMALL OUTLINE INTEGRATED CIRCUIT



4220718/A 09/2016

NOTES:

1. All linear dimensions are in millimeters. Dimensions in parenthesis are for reference only. Dimensioning and tolerancing per ASME Y14.5M.
2. This drawing is subject to change without notice.
3. This dimension does not include mold flash, protrusions, or gate burrs. Mold flash, protrusions, or gate burrs shall not exceed 0.15 mm, per side.
4. This dimension does not include interlead flash. Interlead flash shall not exceed 0.43 mm, per side.
5. Reference JEDEC registration MS-012, variation AB.

EXAMPLE BOARD LAYOUT

D0014A

SOIC - 1.75 mm max height

SMALL OUTLINE INTEGRATED CIRCUIT



LAND PATTERN EXAMPLE
SCALE:8X

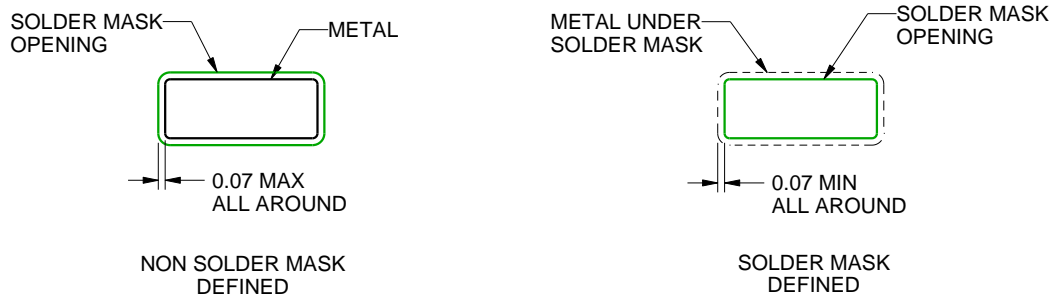

SOLDER MASK DETAILS

4220718/A 09/2016

NOTES: (continued)

- 6. Publication IPC-7351 may have alternate designs.
- 7. Solder mask tolerances between and around signal pads can vary based on board fabrication site.

EXAMPLE STENCIL DESIGN

D0014A

SOIC - 1.75 mm max height

SMALL OUTLINE INTEGRATED CIRCUIT



SOLDER PASTE EXAMPLE
BASED ON 0.125 mm THICK STENCIL
SCALE:8X

4220718/A 09/2016

NOTES: (continued)

8. Laser cutting apertures with trapezoidal walls and rounded corners may offer better paste release. IPC-7525 may have alternate design recommendations.
9. Board assembly site may have different recommendations for stencil design.



D0008A

PACKAGE OUTLINE

SOIC - 1.75 mm max height

SMALL OUTLINE INTEGRATED CIRCUIT



4214825/C 02/2019

NOTES:

- Linear dimensions are in inches [millimeters]. Dimensions in parenthesis are for reference only. Controlling dimensions are in inches. Dimensioning and tolerancing per ASME Y14.5M.
- This drawing is subject to change without notice.
- This dimension does not include mold flash, protrusions, or gate burrs. Mold flash, protrusions, or gate burrs shall not exceed .006 [0.15] per side.
- This dimension does not include interlead flash.
- Reference JEDEC registration MS-012, variation AA.

EXAMPLE BOARD LAYOUT

D0008A

SOIC - 1.75 mm max height

SMALL OUTLINE INTEGRATED CIRCUIT



LAND PATTERN EXAMPLE
 EXPOSED METAL SHOWN
 SCALE:8X



SOLDER MASK DETAILS

4214825/C 02/2019

NOTES: (continued)

- 6. Publication IPC-7351 may have alternate designs.
- 7. Solder mask tolerances between and around signal pads can vary based on board fabrication site.

EXAMPLE STENCIL DESIGN

D0008A

SOIC - 1.75 mm max height

SMALL OUTLINE INTEGRATED CIRCUIT



SOLDER PASTE EXAMPLE
BASED ON .005 INCH [0.125 MM] THICK STENCIL
SCALE:8X

4214825/C 02/2019

NOTES: (continued)

8. Laser cutting apertures with trapezoidal walls and rounded corners may offer better paste release. IPC-7525 may have alternate design recommendations.
9. Board assembly site may have different recommendations for stencil design.

PW0014A



PACKAGE OUTLINE
TSSOP - 1.2 mm max height

SMALL OUTLINE PACKAGE



NOTES:

1. All linear dimensions are in millimeters. Any dimensions in parenthesis are for reference only. Dimensioning and tolerancing per ASME Y14.5M.
2. This drawing is subject to change without notice.
3. This dimension does not include mold flash, protrusions, or gate burrs. Mold flash, protrusions, or gate burrs shall not exceed 0.15 mm per side.
4. This dimension does not include interlead flash. Interlead flash shall not exceed 0.25 mm per side.
5. Reference JEDEC registration MO-153.

EXAMPLE BOARD LAYOUT

PW0014A

TSSOP - 1.2 mm max height

SMALL OUTLINE PACKAGE



LAND PATTERN EXAMPLE
EXPOSED METAL SHOWN
SCALE: 10X



4220202/B 12/2023

NOTES: (continued)

- 6. Publication IPC-7351 may have alternate designs.
- 7. Solder mask tolerances between and around signal pads can vary based on board fabrication site.

EXAMPLE STENCIL DESIGN

PW0014A

TSSOP - 1.2 mm max height

SMALL OUTLINE PACKAGE



SOLDER PASTE EXAMPLE
BASED ON 0.125 mm THICK STENCIL
SCALE: 10X

4220202/B 12/2023

NOTES: (continued)

8. Laser cutting apertures with trapezoidal walls and rounded corners may offer better paste release. IPC-7525 may have alternate design recommendations.
9. Board assembly site may have different recommendations for stencil design.

PW0008A



PACKAGE OUTLINE
TSSOP - 1.2 mm max height

SMALL OUTLINE PACKAGE



4221848/A 02/2015

NOTES:

1. All linear dimensions are in millimeters. Any dimensions in parenthesis are for reference only. Dimensioning and tolerancing per ASME Y14.5M.
2. This drawing is subject to change without notice.
3. This dimension does not include mold flash, protrusions, or gate burrs. Mold flash, protrusions, or gate burrs shall not exceed 0.15 mm per side.
4. This dimension does not include interlead flash. Interlead flash shall not exceed 0.25 mm per side.
5. Reference JEDEC registration MO-153, variation AA.

EXAMPLE BOARD LAYOUT

PW0008A

TSSOP - 1.2 mm max height

SMALL OUTLINE PACKAGE



LAND PATTERN EXAMPLE
SCALE:10X



SOLDER MASK DETAILS
NOT TO SCALE

4221848/A 02/2015

NOTES: (continued)

- 6. Publication IPC-7351 may have alternate designs.
- 7. Solder mask tolerances between and around signal pads can vary based on board fabrication site.

EXAMPLE STENCIL DESIGN

PW0008A

TSSOP - 1.2 mm max height

SMALL OUTLINE PACKAGE



SOLDER PASTE EXAMPLE
BASED ON 0.125 mm THICK STENCIL
SCALE:10X

4221848/A 02/2015

NOTES: (continued)

8. Laser cutting apertures with trapezoidal walls and rounded corners may offer better paste release. IPC-7525 may have alternate design recommendations.
9. Board assembly site may have different recommendations for stencil design.

IMPORTANT NOTICE AND DISCLAIMER

TI PROVIDES TECHNICAL AND RELIABILITY DATA (INCLUDING DATA SHEETS), DESIGN RESOURCES (INCLUDING REFERENCE DESIGNS), APPLICATION OR OTHER DESIGN ADVICE, WEB TOOLS, SAFETY INFORMATION, AND OTHER RESOURCES "AS IS" AND WITH ALL FAULTS, AND DISCLAIMS ALL WARRANTIES, EXPRESS AND IMPLIED, INCLUDING WITHOUT LIMITATION ANY IMPLIED WARRANTIES OF MERCHANTABILITY, FITNESS FOR A PARTICULAR PURPOSE OR NON-INFRINGEMENT OF THIRD PARTY INTELLECTUAL PROPERTY RIGHTS.

These resources are intended for skilled developers designing with TI products. You are solely responsible for (1) selecting the appropriate TI products for your application, (2) designing, validating and testing your application, and (3) ensuring your application meets applicable standards, and any other safety, security, regulatory or other requirements.

These resources are subject to change without notice. TI grants you permission to use these resources only for development of an application that uses the TI products described in the resource. Other reproduction and display of these resources is prohibited. No license is granted to any other TI intellectual property right or to any third party intellectual property right. TI disclaims responsibility for, and you will fully indemnify TI and its representatives against, any claims, damages, costs, losses, and liabilities arising out of your use of these resources.

TI's products are provided subject to [TI's Terms of Sale](#) or other applicable terms available either on [ti.com](https://www.ti.com) or provided in conjunction with such TI products. TI's provision of these resources does not expand or otherwise alter TI's applicable warranties or warranty disclaimers for TI products.

TI objects to and rejects any additional or different terms you may have proposed.

Mailing Address: Texas Instruments, Post Office Box 655303, Dallas, Texas 75265

Copyright © 2025, Texas Instruments Incorporated