

FEATURES

- **Controlled Baseline**
 - One Assembly/Test Site, One Fabrication Site
- **Extended Temperature Performance of –55°C to 125°C**
- **Enhanced Diminishing Manufacturing Sources (DMS) Support**
- **Enhanced Product-Change Notification**
- **Qualification Pedigree⁽¹⁾**
- **Outstanding Combination of DC Precision and AC Performance:**
 - **Unity-Gain Bandwidth . . . 13 MHz Typ**
 - **V_n . . . 3.3 nV/ $\sqrt{\text{Hz}}$ at $f = 10 \text{ Hz}$ Typ,
2.5 nV/ $\sqrt{\text{Hz}}$ at $f = 1 \text{ kHz}$ Typ**

- V_{IO} . . . 100 μV Max
- A_{VD} . . . 45 V/ μV Typ With $R_L = 2 \text{ k}\Omega$,
19 V/ μV Typ With $R_L = 600 \Omega$
- **Available in Standard-Pinout Small-Outline Package**
- **Output Features Saturation Recovery Circuitry**
- **Macromodels and Statistical information**

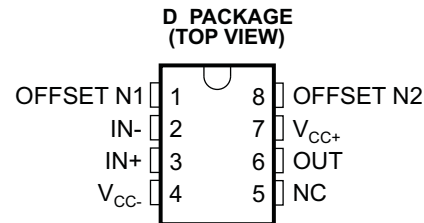

⁽¹⁾ Component qualification in accordance with JEDEC and industry standards to ensure reliable operation over an extended temperature range. This includes, but is not limited to, Highly Accelerated Stress Test (HAST) or biased 85/85, temperature cycle, autoclave or unbiased HAST, electromigration, bond intermetallic life, and mold compound life. Such qualification testing should not be viewed as justifying use of this component beyond specified performance and environmental limits.

DESCRIPTION

The TLE2027 contains innovative circuit design expertise and high-quality process control techniques to produce a level of ac performance and dc precision previously unavailable in single operational amplifiers. Manufactured using TI's state-of-the-art Excalibur process, these devices allow upgrades to systems that use lower-precision devices.

In the area of dc precision, the TLE2027 offers maximum offset voltages of 100 μV , common-mode rejection ratio of 131 dB (typ), supply voltage rejection ratio of 144 dB (typ), and dc gain of 45 V/ μV (typ).

The ac performance of the TLE2027 is highlighted by a typical unity-gain bandwidth specification of 15 MHz, 55° of phase margin, and noise voltage specifications of 3.3 nV/ $\sqrt{\text{Hz}}$ and 2.5 nV/ $\sqrt{\text{Hz}}$ at frequencies of 10 Hz and 1 kHz, respectively.

The TLE2027 is available in a wide variety of packages, including the industry-standard 8-pin small-outline version for high-density system applications. The device is characterized for operation over the full military temperature range of –55°C to 125°C.

ORDERING INFORMATION⁽¹⁾

T_A	$V_{IO\text{max}}$ AT 25°C	PACKAGED DEVICES
		SMALL OUTLINE ⁽²⁾ (D)
–55°C to 125°C	100 μV	TLE2027MDREP

- (1) For the most current package and ordering information, see the Package Option Addendum at the end of this document, or see the TI website at www.ti.com.
- (2) The D package is available taped and reeled with 2500 units/reel.



Please be aware that an important notice concerning availability, standard warranty, and use in critical applications of Texas Instruments semiconductor products and disclaimers thereto appears at the end of this data sheet.

All trademarks are the property of their respective owners.

SYMBOL

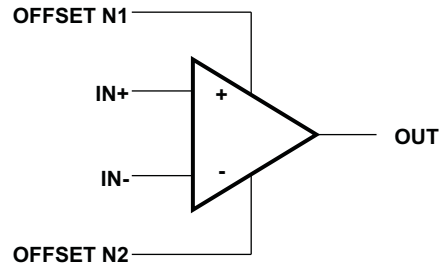

TLE202XY CHIP INFORMATION

This chip, when properly assembled, displays characteristics similar to the TLE202xC. Thermal compression or ultrasonic bonding may be used on the doped-aluminum bonding pads. The chip may be mounted with conductive epoxy or a gold-silicon preform.

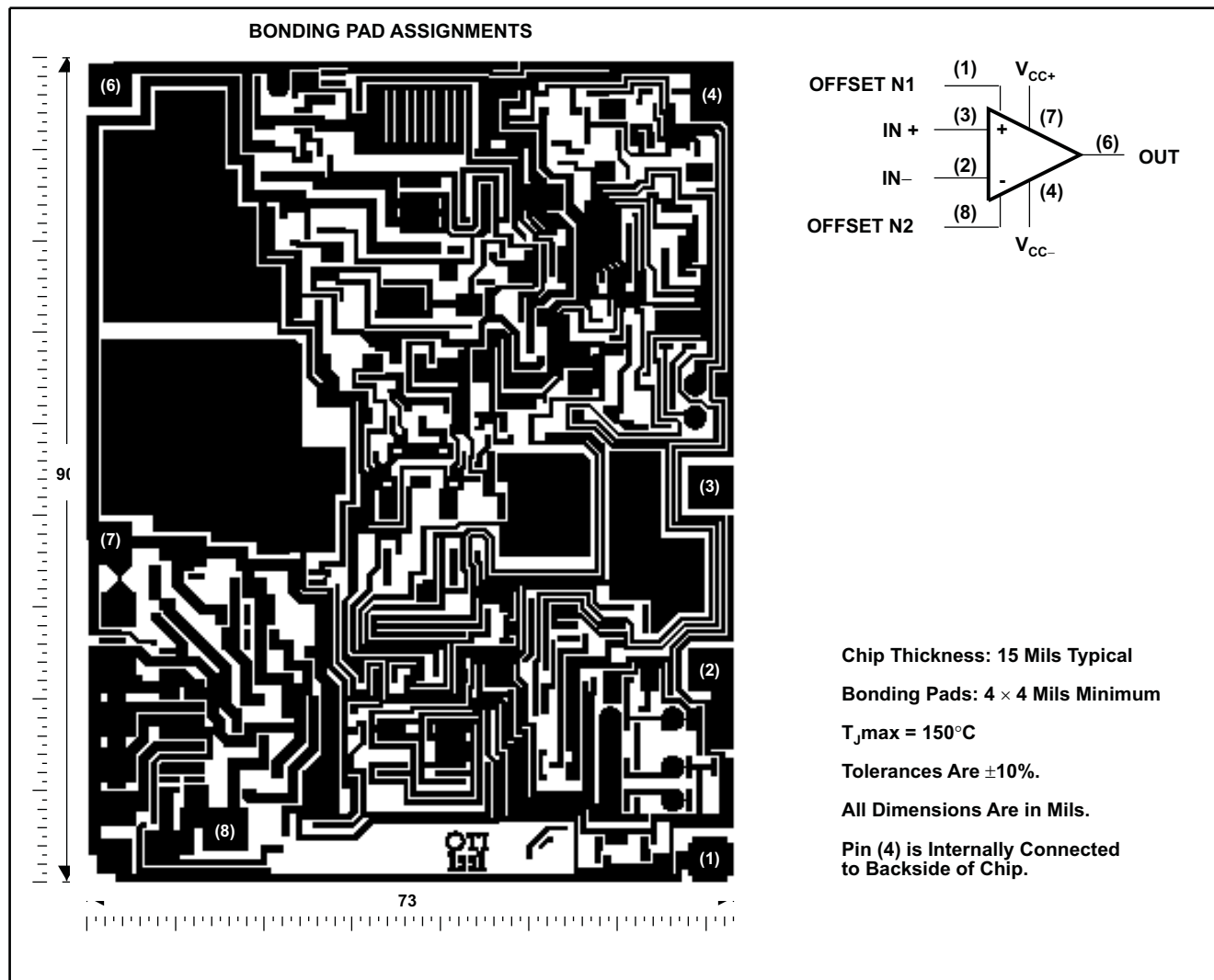

EQUIVALENT SCHEMATIC

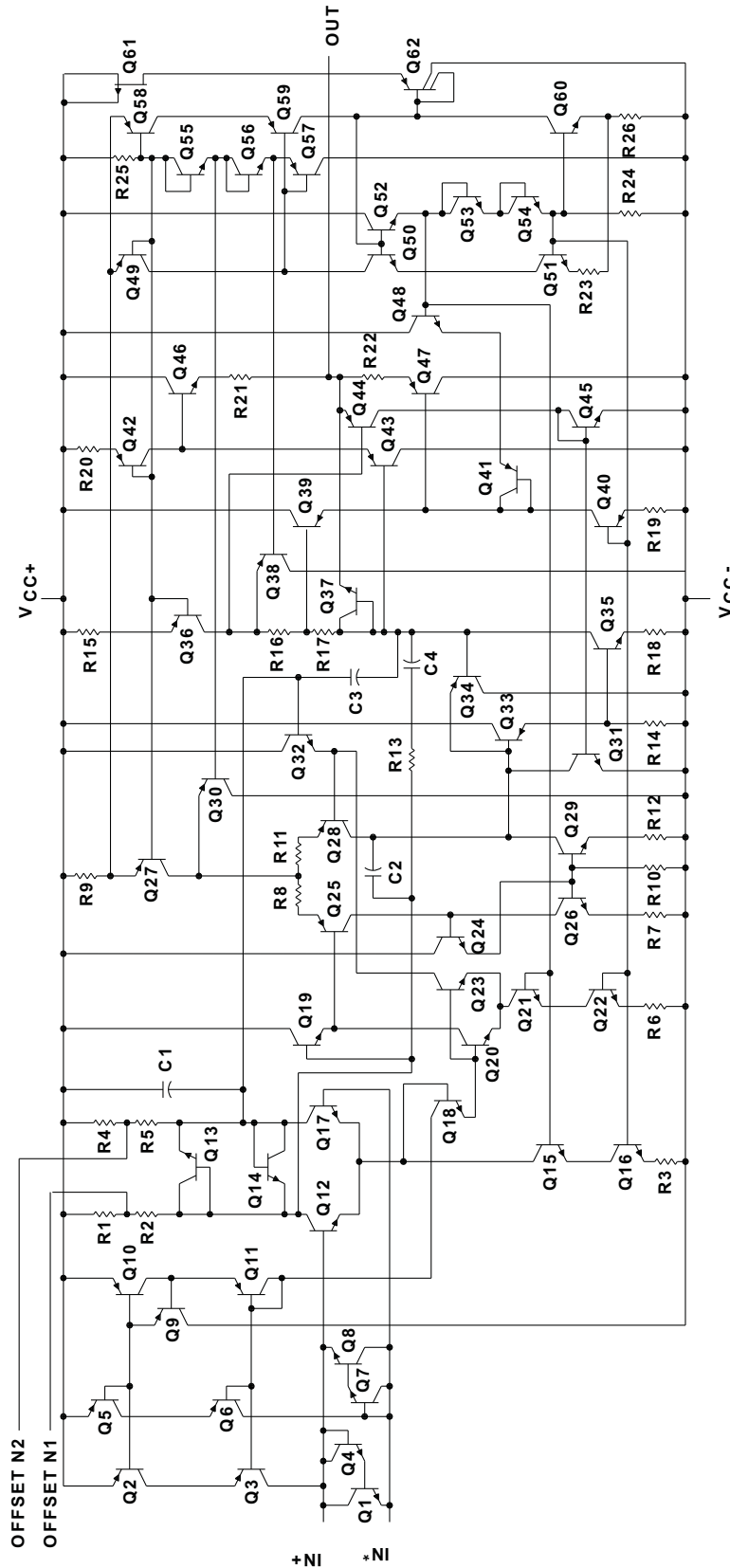

ACTUAL DEVICE COMPONENT COUNT	
Transistors	61
Resistors	26
epiFET	1
Capacitors	4

Absolute Maximum Ratings⁽¹⁾

over operating free-air temperature range (unless otherwise noted)

		MIN	MAX	UNIT
V _{CC+}	Supply voltage ⁽²⁾		19	V
V _{CC-}	Supply voltage		-19	V
V _{ID}	Differential input voltage ⁽³⁾		±1.2	V
V _I	Input voltage range (any input)		V _{CC±}	
I _I	Input current (each input)		±1	mA
I _O	Output current		±50	mA
	Total current into V _{CC+}		50	mA
	Total current out of V _{CC-}		50	mA
	Duration of short-circuit current at (or below) 25°C ⁽⁴⁾		Unlimited	
	Continuous total power dissipation		See Dissipation Rating Table	
T _A	Operating free-air temperature range	-55	125	°C
T _{stg}	Storage temperature range ⁽⁵⁾	-65	150	°C
	Lead temperature 1,6 mm (1/16 in) from case for 10 s		260	°C
				D package

- (1) Stresses beyond those listed under "absolute maximum ratings" may cause permanent damage to the device. These are stress ratings only, and functional operation of the device at these or any other conditions beyond those indicated under "recommended operating conditions" is not implied. Exposure to absolute-maximum-rated conditions for extended periods may affect device reliability.
- (2) All voltage values, except differential voltages, are with respect to the midpoint between V_{CC+} and V_{CC-}.
- (3) Differential voltages are at IN+ with respect to IN-. Excessive current flows if a differential input voltage in excess of approximately ±1.2 V is applied between the inputs, unless some limiting resistance is used.
- (4) The output may be shorted to either supply. Temperature and/or supply voltages must be limited to ensure that the maximum dissipation rating is not exceeded.
- (5) Long-term high-temperature storage and/or extended use at maximum recommended operating conditions may result in a reduction of overall device life. See http://www.ti.com/ep_quality for additional information on enhanced product packaging.

Dissipation Rating Table

PACKAGE	T _A ≤ 25°C POWER RATING	DERATING FACTOR ABOVE T _A = 25°C	T _A = 70°C POWER RATING	T _A = 105°C POWER RATING	T _A = 125°C POWER RATING
D	725 mW	5.8 mW/°C	464 mW	261 mW	145 mW

Recommended Operating Conditions

		MIN	MAX	UNIT	
V _{CC±}	Supply voltage	±4	±19	V	
V _{IC}	Common-mode input voltage	T _A = 25°C	-11	11	V
		T _A = Full range ⁽¹⁾	-10.3	10.3	
T _A	Operating free-air temperature	-55	125	°C	

- (1) Full range is -55°C to 125°C.

Electrical Characteristics

at specified free-air temperature, $V_{CC\pm} = \pm 15\text{ V}$ (unless otherwise noted)

PARAMETER		TEST CONDITIONS	T_A ⁽¹⁾	MIN	TYP	MAX	UNIT
V_{IO}	Input offset voltage	$V_{IC} = 0, R_S = 50\ \Omega$	25°C		20	100	μV
			Full range			200	
α_{VIO}	Temperature coefficient of input offset voltage	$V_{IC} = 0, R_S = 50\ \Omega$	Full range		0.4		$\mu\text{V}/^\circ\text{C}$
	Input offset voltage long-term drift ⁽²⁾	$V_{IC} = 0, R_S = 50\ \Omega$	25°C		0.006		$\mu\text{V}/\text{mo}$
I_{IO}	Input offset current	$V_{IC} = 0, R_S = 50\ \Omega$	25°C		6	90	nA
			Full range			150	
I_{IB}	Input bias current	$V_{IC} = 0, R_S = 50\ \Omega$	25°C		15	90	nA
			Full range			150	
V_{ICR}	Common-mode input voltage range	$R_S = 50\ \Omega$	25°C	-11 to 11	-13 to 13		V
			Full range		-10.3 to 10.3		
V_{OM+}	Maximum positive peak output voltage swing	$R_L = 600\ \Omega$	25°C	10.5	12.9		V
			Full range		10		
		$R_L = 2\ \text{k}\Omega$	25°C	12	13.2		
			Full range		11		
V_{OM-}	Maximum negative peak output voltage swing	$R_L = 600\ \Omega$	25°C	-10.5	-13		V
			Full range		-10		
		$R_L = 2\ \text{k}\Omega$	25°C	-12	-13.5		
			Full range		-11		
A_{VD}	Large-signal differential voltage amplification	$V_O = \pm 11\ \text{V}, R_L = 2\ \text{k}\Omega$	25°C	5	45		$\text{V}/\mu\text{V}$
		$V_O = \pm 10\ \text{V}, R_L = 2\ \text{k}\Omega$	Full range		2.5		
		$V_O = \pm 10\ \text{V}, R_L = 1\ \text{k}\Omega$	25°C	3.5	38		
		$V_O = \pm 10\ \text{V}, R_L = 600\ \Omega$	25°C	2	19		
C_i	Input capacitance		25°C		8		pF
Z_o	Open-loop output impedance	$I_O = 0$	25°C		50		Ω
CMRR	Common-mode rejection ratio	$V_{IC} = V_{ICRmin}, R_S = 50\ \Omega$	25°C	100	131		dB
			Full range		96		
k_{SVR}	Supply-voltage rejection ratio ($\Delta V_{CC\pm}/\Delta V_{IO}$)	$V_{CC\pm} = \pm 4\ \text{V to } \pm 18\ \text{V}, R_S = 50\ \Omega$	25°C	94	144		dB
		$V_{CC\pm} = \pm 4\ \text{V to } \pm 18\ \text{V}, R_S = 50\ \Omega$	Full range		90		
I_{CC}	Supply current	$V_O = 0, \text{ No load}$	25°C		3.8	5.3	mA
			Full range			5.6	

(1) Full range is -55°C to 125°C .

(2) Typical values are based on the input offset voltage shift observed through 168 hours of operating life test at $T_A = 150^\circ\text{C}$ extrapolated to $T_A = 25^\circ\text{C}$ using the Arrhenius equation and assuming an activation energy of 0.96 eV.

Operating Characteristics

 at specified free-air temperature, $V_{CC\pm} = \pm 15\text{ V}$, $T_A = 25^\circ\text{C}$ (unless otherwise noted)

PARAMETER		TEST CONDITIONS	MIN	TYP	MAX	UNIT
SR	Slew rate at unity gain	$R_L = 2\text{ k}\Omega$, $C_L = 100\text{ pF}$, See Figure 1	1.7	2.8		V/ μs
		$R_L = 2\text{ k}\Omega$, $C_L = 100\text{ pF}$, $T_A = -55^\circ\text{C}$ to 125°C , See Figure 1	1			
V_n	Equivalent input noise voltage (see Figure 2)	$R_S = 20\ \Omega$	$f = 10\text{ Hz}$	3.3		nV/ $\sqrt{\text{Hz}}$
			$f = 1\text{ kHz}$	2.5		
$V_{N(PP)}$	Peak-to-peak equivalent input noise voltage	$f = 0.1\text{ Hz}$ to 10 Hz		50		nV
I_n	Equivalent input noise current	$f = 10\text{ Hz}$		1.5		pA/ $\sqrt{\text{Hz}}$
		$f = 1\text{ kHz}$		0.4		
THD	Total harmonic distortion	$V_O = 10\text{ V}$, $A_{VD} = 1^{(1)}$		<0.002%		
B_1	Unity-gain bandwidth (see Figure 3)	$R_L = 2\text{ k}\Omega$, $C_L = 100\text{ pF}$		13		MHz
B_{OM}	Maximum output-swing bandwidth	$R_L = 2\text{ k}\Omega$		30		kHz
ϕ_m	Phase margin at unity gain (see Figure 3)	$R_L = 2\text{ k}\Omega$, $C_L = 100\text{ pF}$		55°		

(1) Measured distortion of the source used in the analysis was 0.002%.

PARAMETER MEASUREMENT INFORMATION

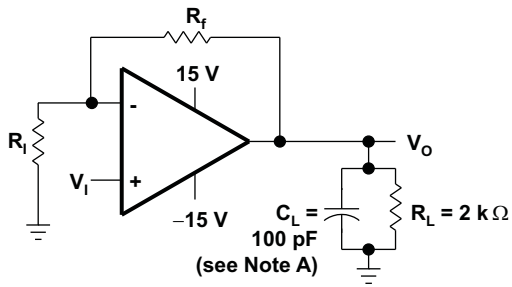

NOTE A: C_L includes fixture capacitance.

Figure 1. Slew-Rate Test Circuit

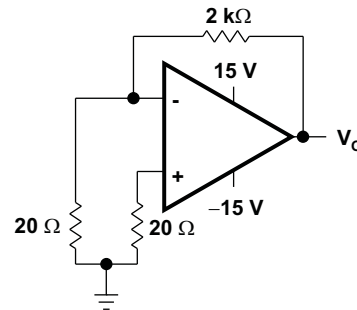
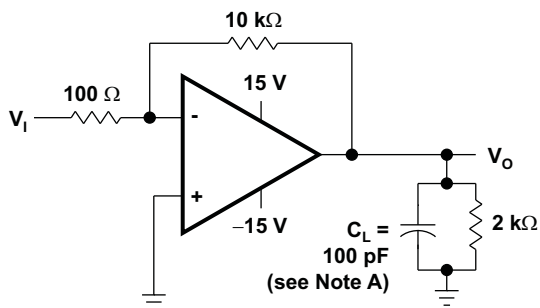
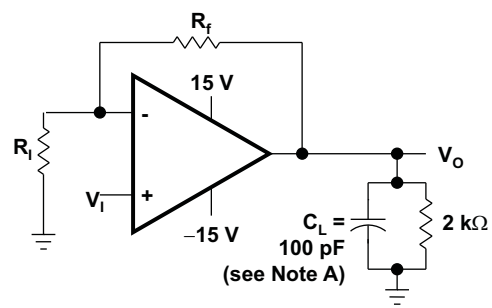

Figure 2. Noise-Voltage Test Circuit



NOTE A: C_L includes fixture capacitance.

Figure 3. Unity-Gain Bandwidth and Phase-Margin Test Circuit



NOTE A: C_L includes fixture capacitance.

Figure 4. Small-Signal Pulse-Response Test Circuit

DEVICE INFORMATION

Typical Values

Typical values presented in this data sheet represent the median (50% point) of device parametric performance.

Initial Estimates of Parameter Distributions

In the ongoing program of improving data sheets and supplying more information to our customers, Texas Instruments has added an estimate of not only the typical values but also the spread around these values. These are in the form of distribution bars that show the 95% (upper) points and the 5% (lower) points from the characterization of the initial wafer lots of this new device type (see Figure 5). The distribution bars are shown at the points where data was actually collected. The 95% and 5% points are used instead of ± 3 sigma since some of the distributions are not true Gaussian distributions.

The number of units tested and the number of different wafer lots used are on all of the graphs where distribution bars are shown. As noted in Figure 5, there were a total of 835 units from two wafer lots. In this case, there is a good estimate for the within-lot variability and a possibly poor estimate of the lot-to-lot variability. This is always the case on newly released products since there can only be data available from a few wafer lots.

The distribution bars are not intended to replace the minimum and maximum limits in the electrical tables. Each distribution bar represents 90% of the total units tested at a specific temperature. While 10% of the units tested fell outside any given distribution bar, this should not be interpreted to mean that the same individual devices fell outside every distribution bar.

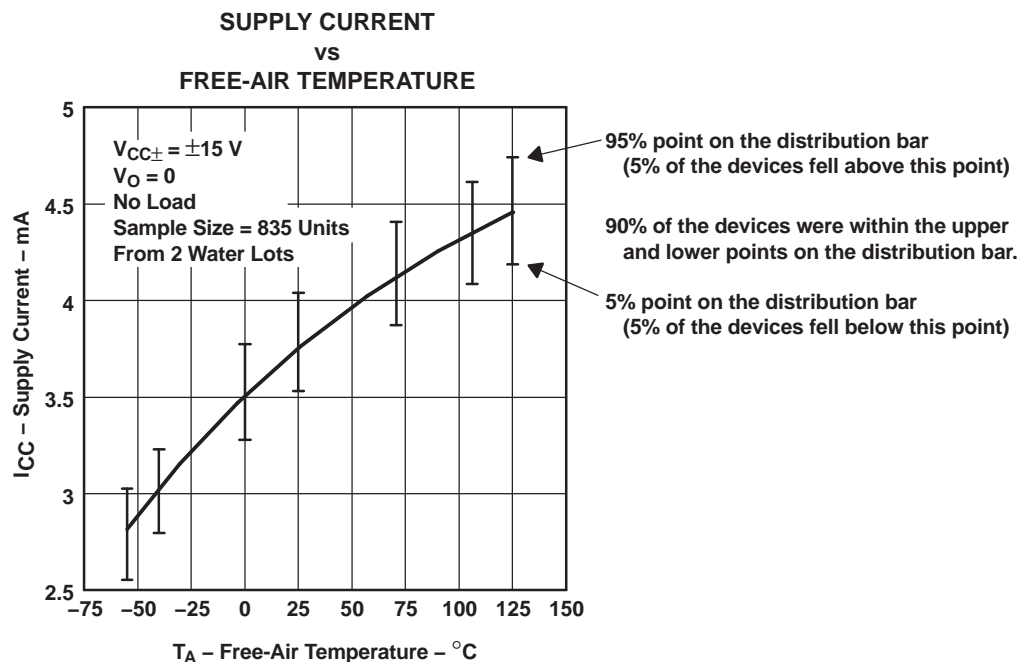

Figure 5. Sample Graph With Distribution Bars

TYPICAL CHARACTERISTICS

Table of Graphs

		FIGURE	
V_{IO}	Input offset voltage	Distribution	6,
ΔV_{IO}	Input offset voltage change	vs Time after power on	7, 8
I_{IO}	Input offset current	vs Free-air temperature	9
I_{IB}	Input bias current	vs Free-air temperature	10
		vs Common-mode input voltage	11
I_I	Input current	vs Differential input voltage	12
$V_{O(PP)}$	Maximum peak-to-peak output voltage	vs Frequency	13, 14
V_{OM}	Maximum (positive/negative) peak output voltage	vs Load resistance	15, 16
		vs Free-air temperature	17, 18
A_{VD}	Large-signal differential voltage amplification	vs Supply voltage	19
		vs Load resistance	20
		vs Frequency	21, 22
		vs Free-air temperature	23
Z_o	Output impedance	vs Frequency	24
CMRR	Common-mode rejection ratio	vs Frequency	25
k_{SVR}	Supply-voltage rejection ratio	vs Frequency	26
I_{OS}	Short-circuit output current	vs Supply voltage	27, 28
		vs Elapsed time	29, 30
		vs Free-air temperature	31, 32
I_{CC}	Supply current	vs Supply voltage	33
		vs Free-air temperature	34
	Voltage-follower pulse response	Small signal	35
		Large signal	36
V_n	Equivalent input noise voltage	vs Frequency	37
	Noise voltage (referred to input)	Over 10-s interval	38
B_1	Unity-gain bandwidth	vs Supply voltage	39
		vs Load capacitance	40
SR	Slew rate	vs Free-air temperature	41
ϕ_m	Phase margin	vs Supply voltage	42
		vs Loadcapacitance	43
		vs Free-air temperature	44

TYPICAL CHARACTERISTICS

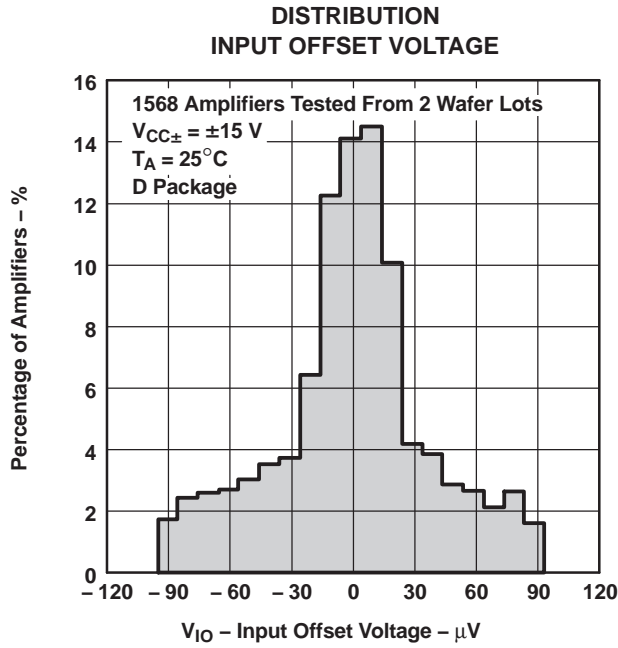

Figure 6.

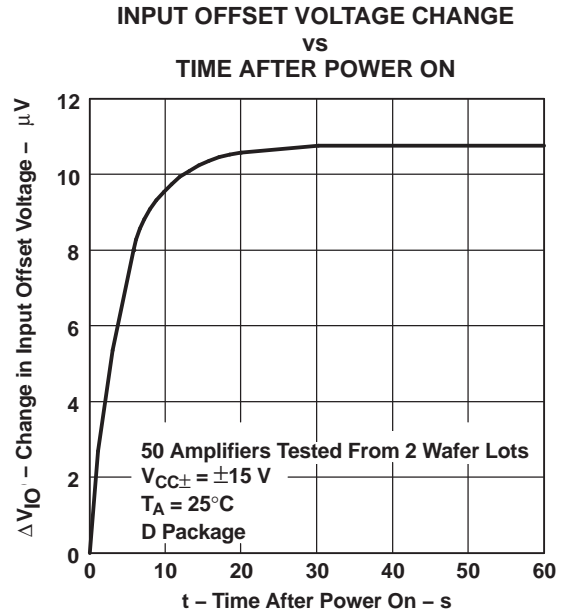

Figure 7.

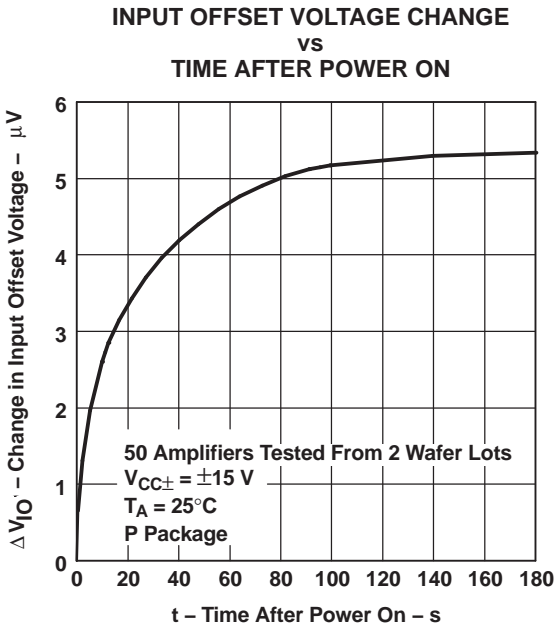

Figure 8.

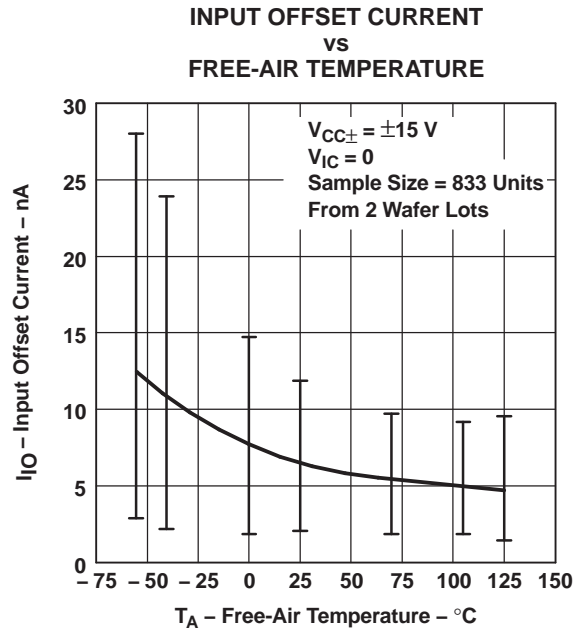
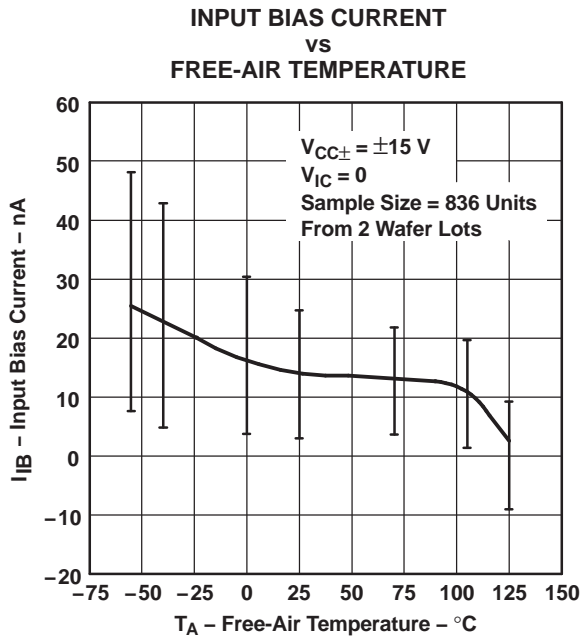

Figure 9.

NOTE A: Data at high and low temperatures are applicable only within the rated operating free-air temperature ranges of the various devices.

TYPICAL CHARACTERISTICS (continued)



NOTE A: Data at high and low temperatures are applicable only within the rated operating free-air temperature ranges of the various devices.

Figure 10.

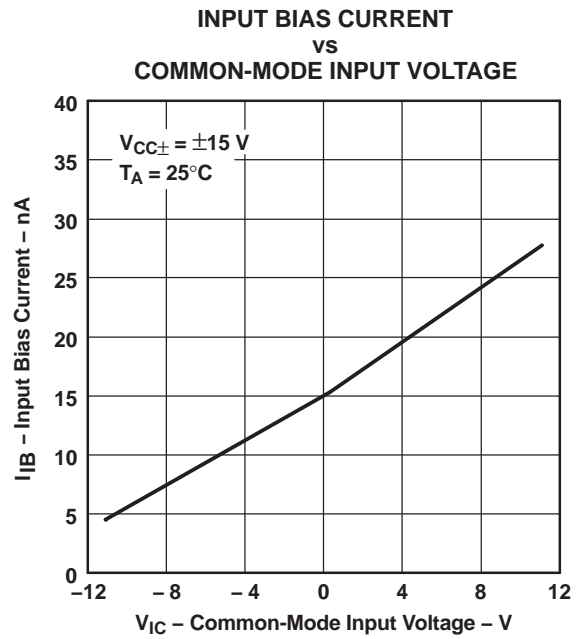

Figure 11.

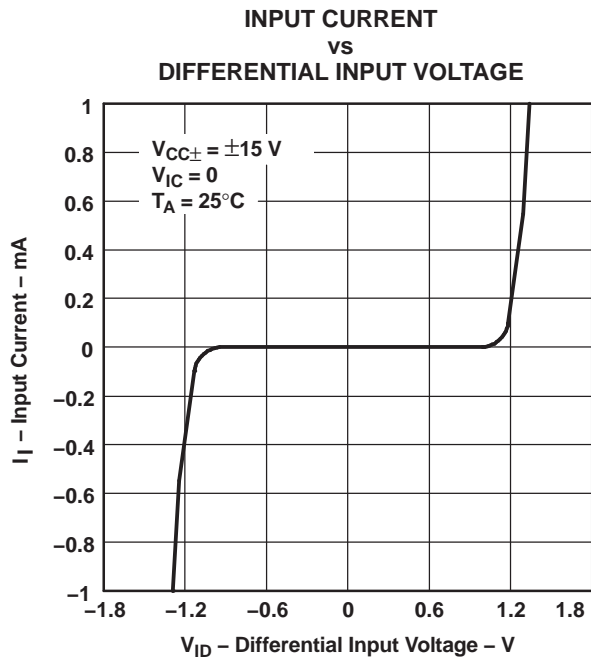
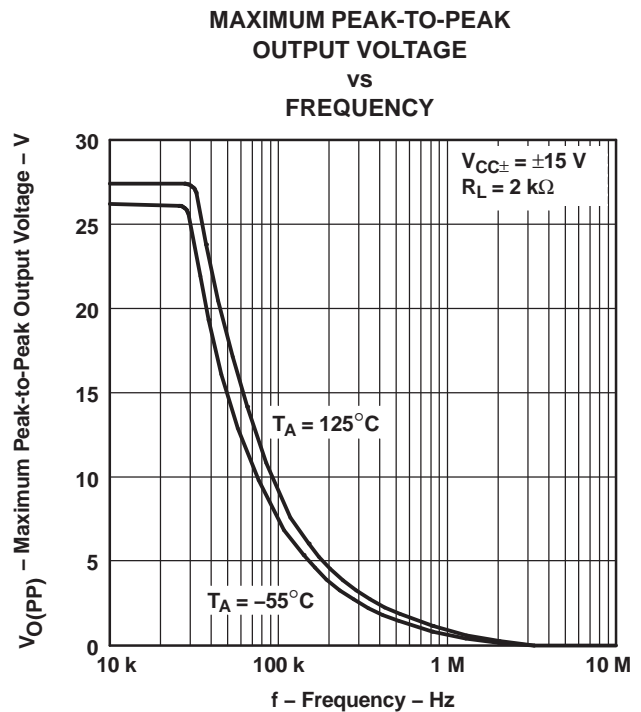

Figure 12.



NOTE A: Data at high and low temperatures are applicable only within the rated operating free-air temperature ranges of the various devices.

Figure 13.

TYPICAL CHARACTERISTICS (continued)

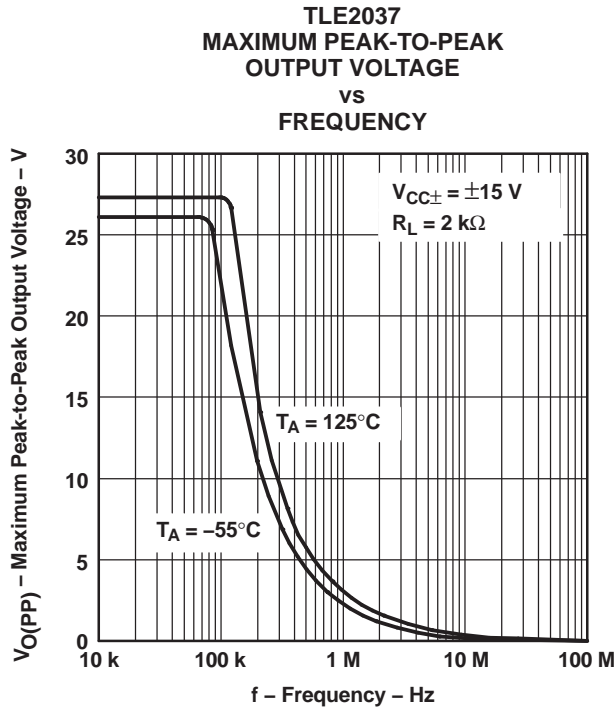

NOTE A: Data at high and low temperatures are applicable only within the rated operating free-air temperature ranges of the various devices.

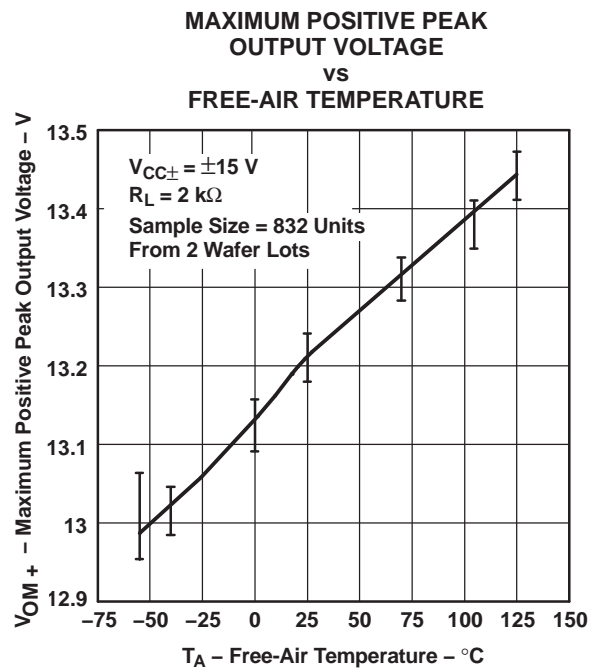
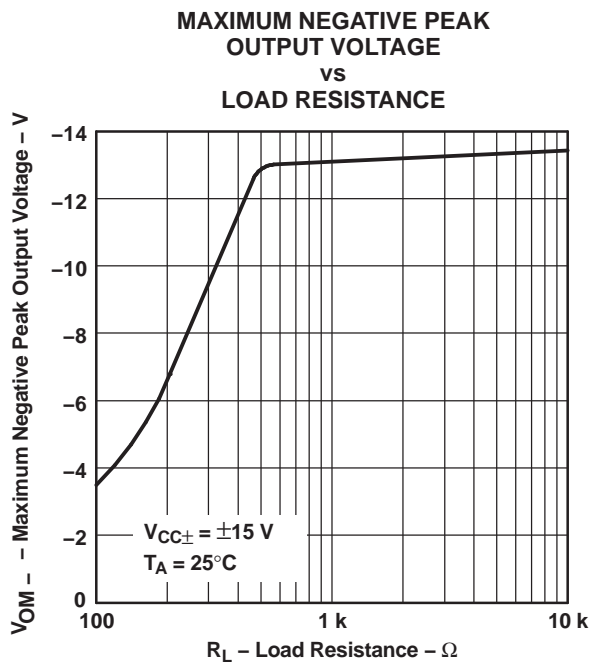
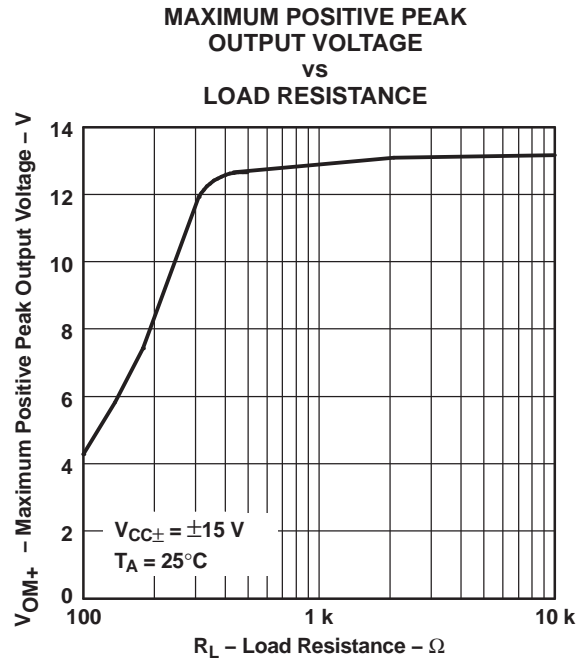

NOTE A: Data at high and low temperatures are applicable only within the rated operating free-air temperature ranges of the various devices.

TYPICAL CHARACTERISTICS (continued)

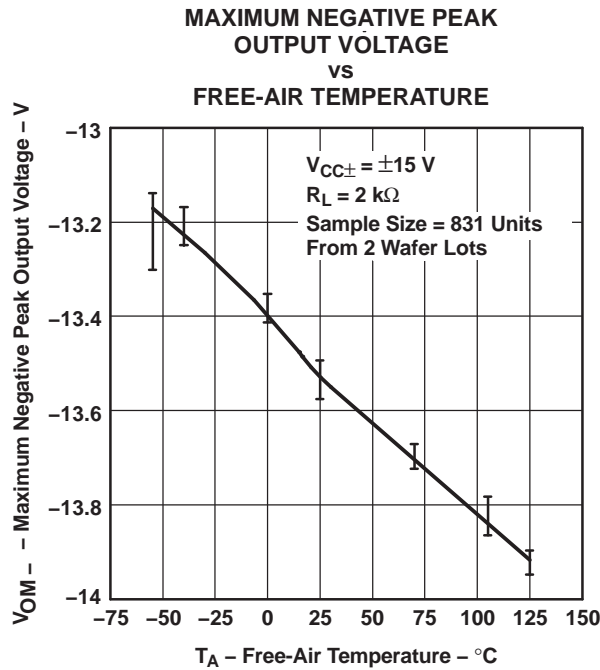

Figure 18.

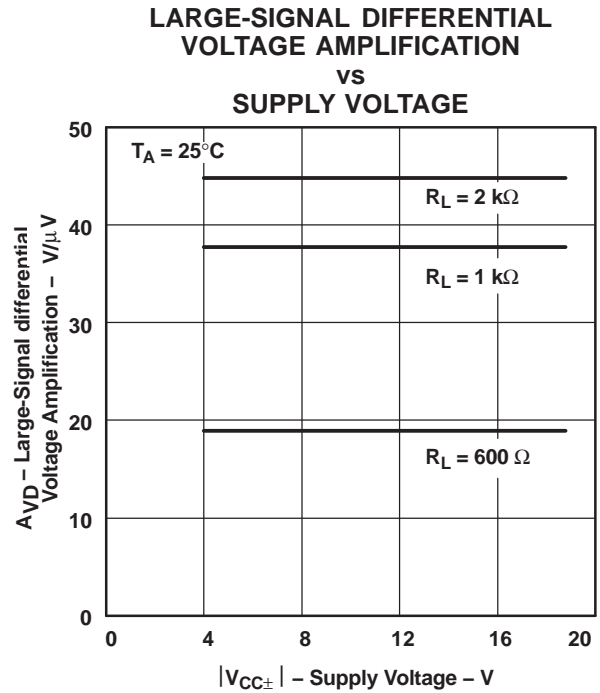

Figure 19.

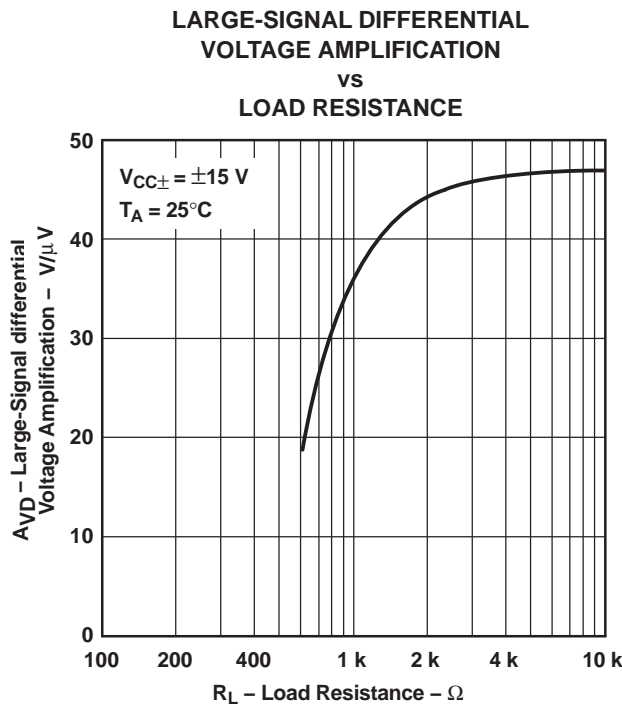

Figure 20.

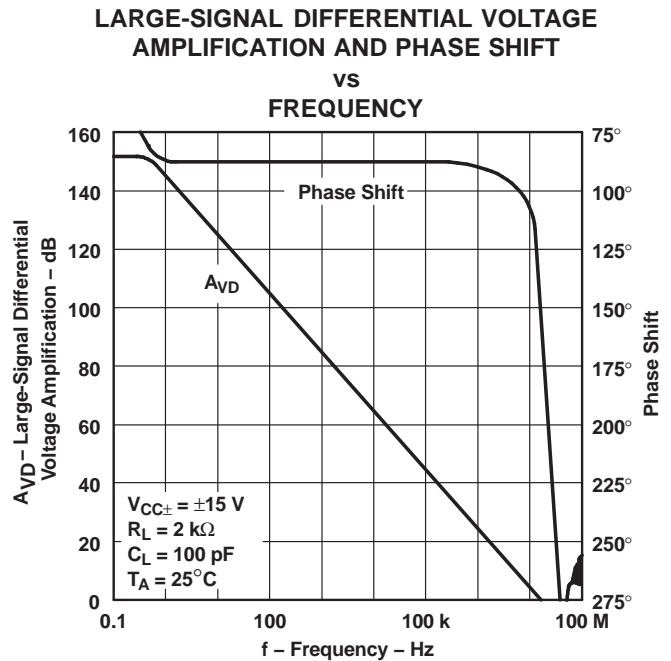

Figure 21.

TYPICAL CHARACTERISTICS (continued)

LARGE-SIGNAL DIFFERENTIAL VOLTAGE AMPLIFICATION AND PHASE SHIFT VS FREQUENCY

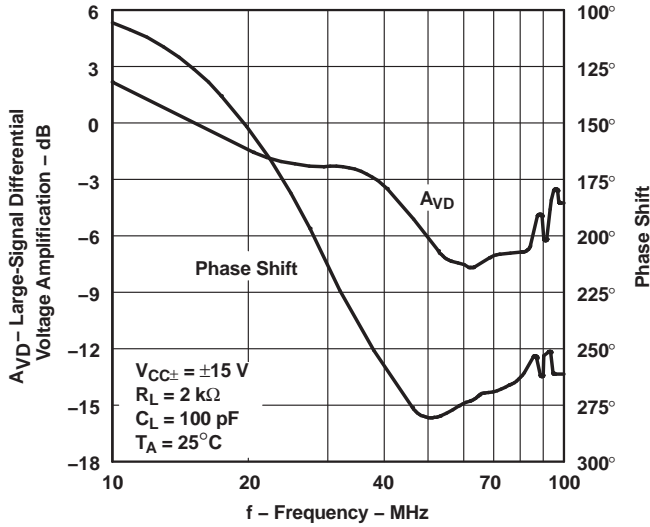

Figure 22.

LARGE-SIGNAL DIFFERENTIAL VOLTAGE AMPLIFICATION VS FREE-AIR TEMPERATURE

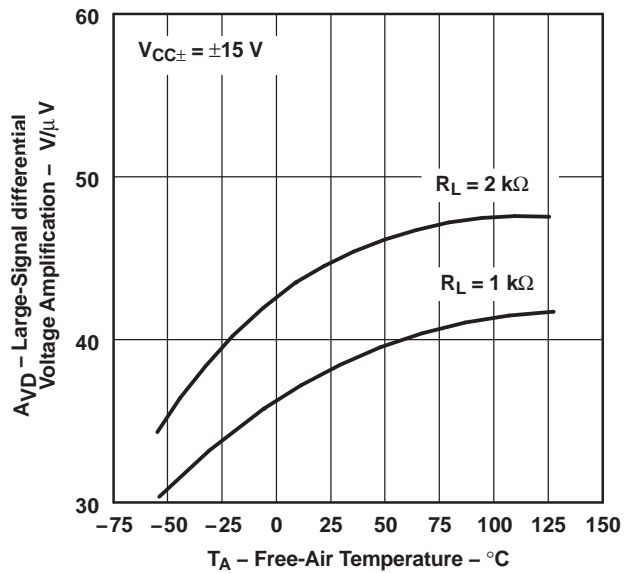
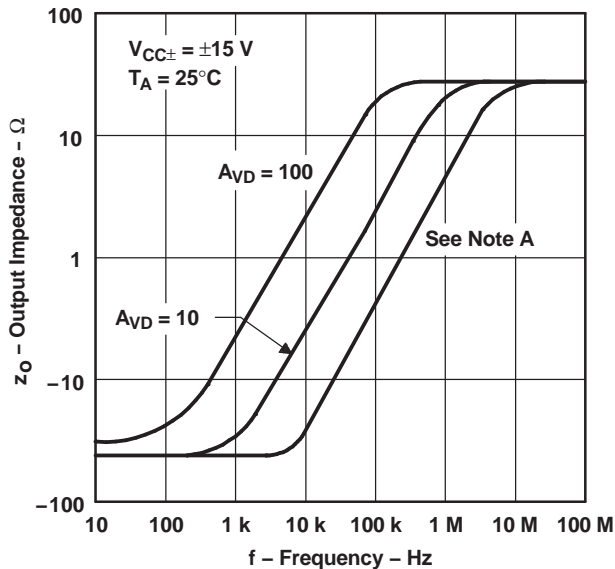

Figure 23.

OUTPUT IMPEDANCE VS FREQUENCY



NOTE A: For this curve, $A_{VD} = 1$

Figure 24.

COMMON-MODE REJECTION RATIO VS FREQUENCY

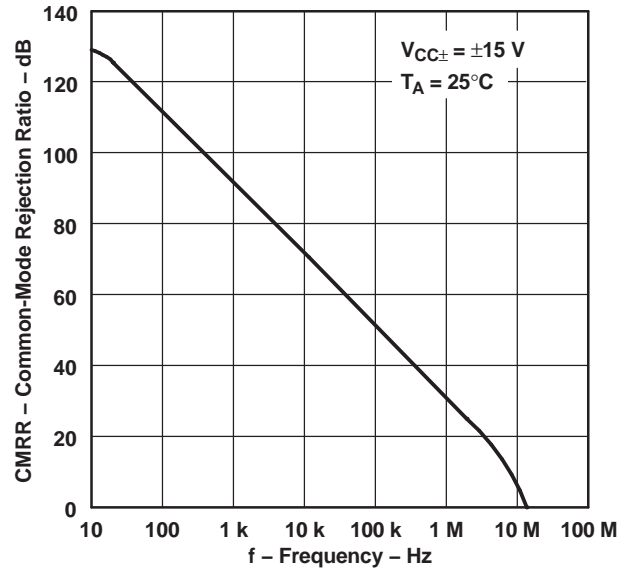
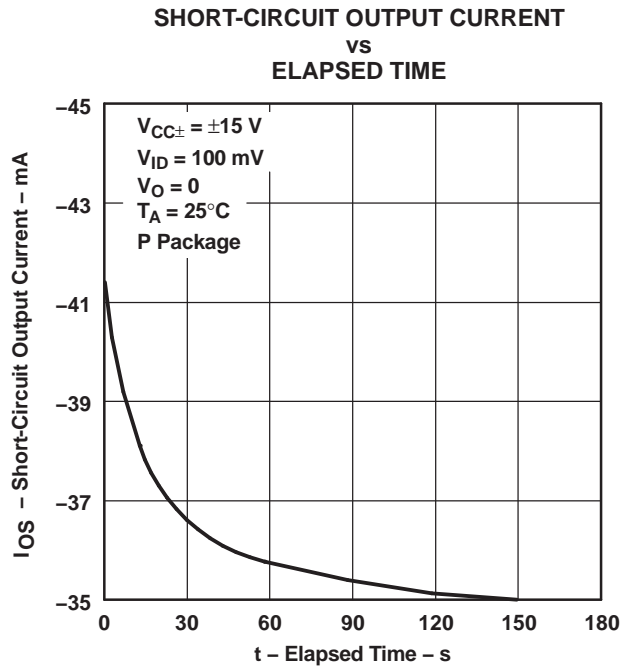
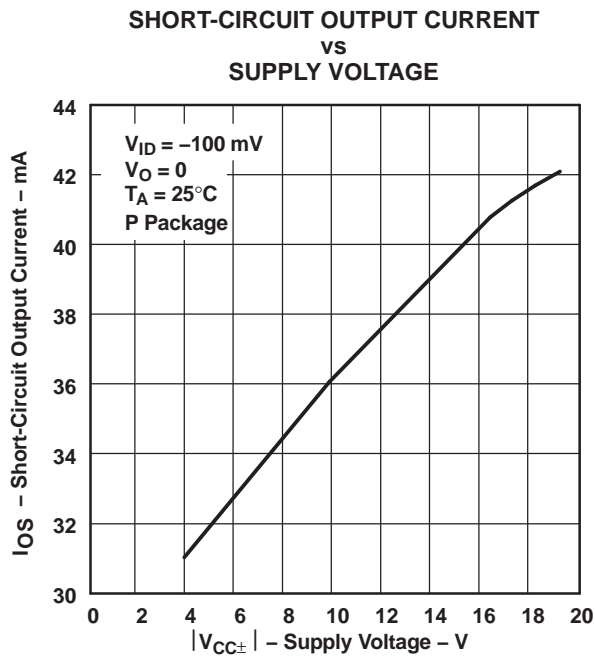
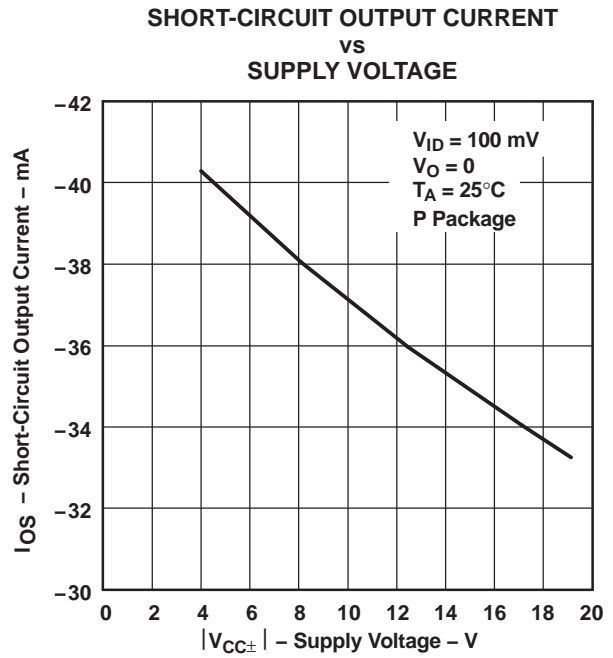
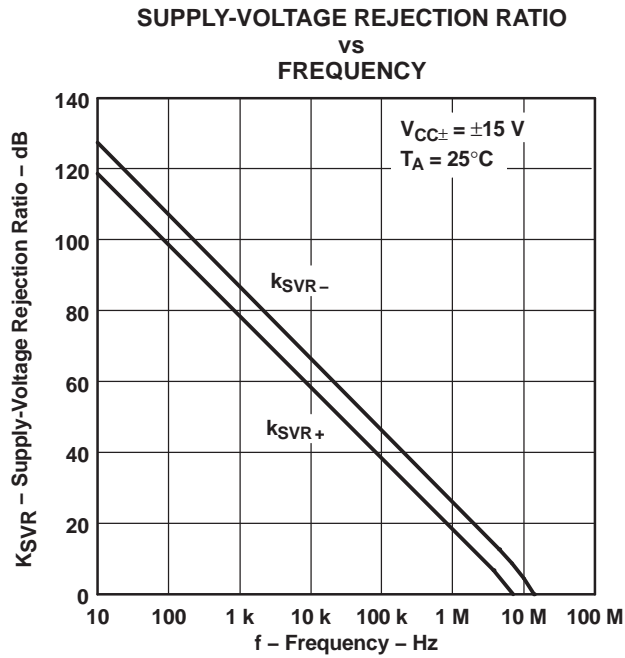

Figure 25.

TYPICAL CHARACTERISTICS (continued)



TYPICAL CHARACTERISTICS (continued)

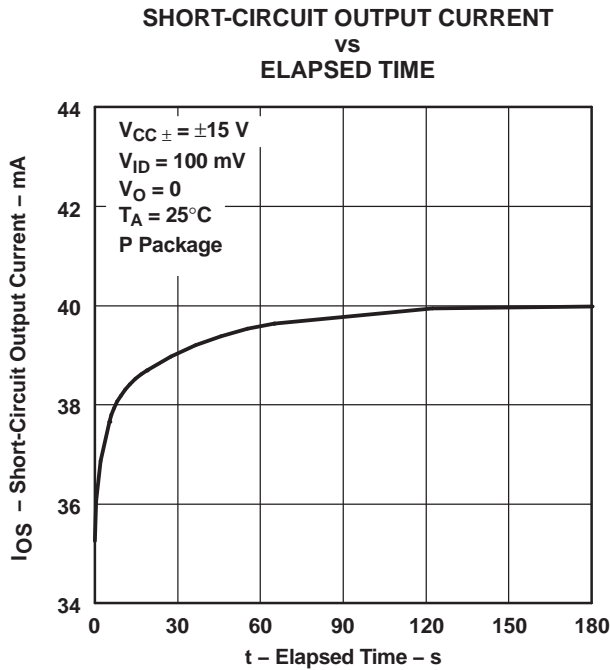
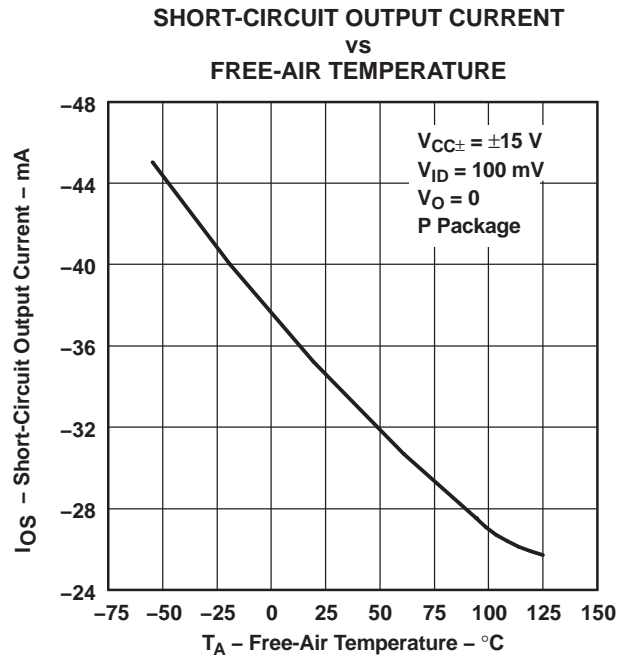
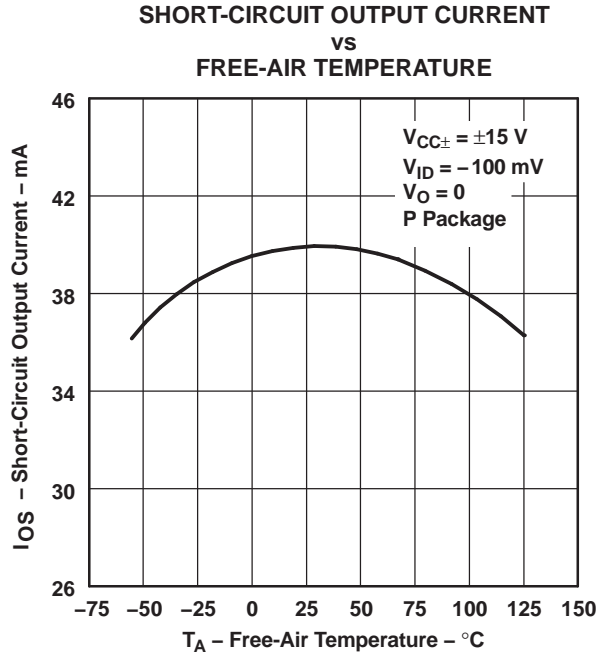

Figure 30.



NOTE A: Data at high and low temperatures are applicable only within the rated operating free-air temperature ranges of the various devices.

Figure 31.



NOTE A: Data at high and low temperatures are applicable only within the rated operating free-air temperature ranges of the various devices.

Figure 32.

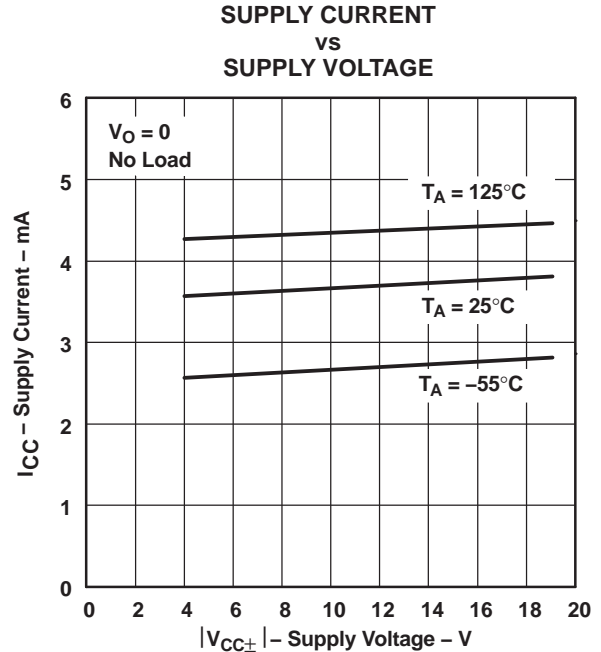

NOTE A: Data at high and low temperatures are applicable only within the rated operating free-air temperature ranges of the various devices.

Figure 33.

TYPICAL CHARACTERISTICS (continued)

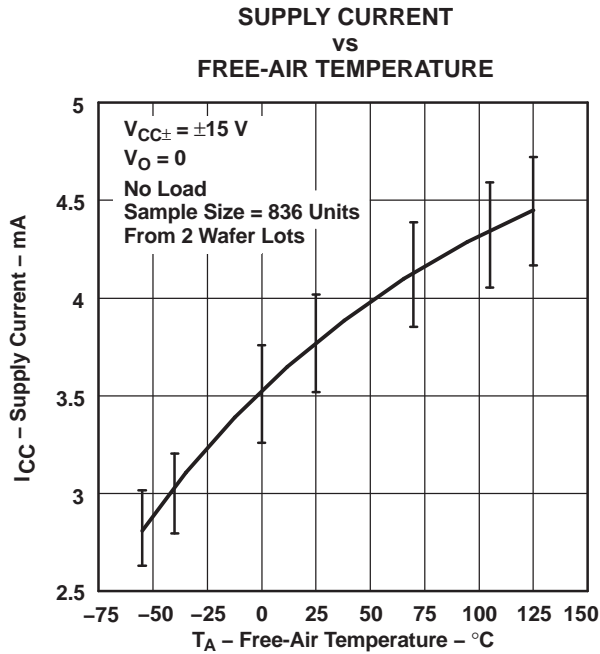

NOTE A: Data at high and low temperatures are applicable only within the rated operating free-air temperature ranges of the various devices.

Figure 34.

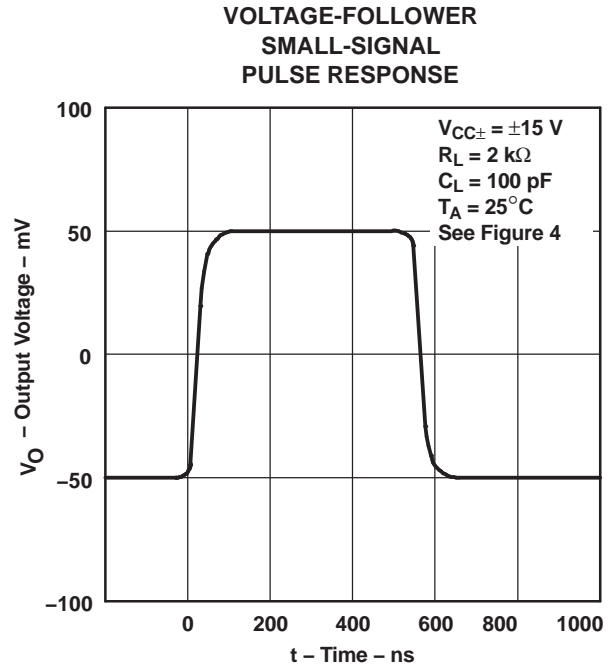

Figure 35.

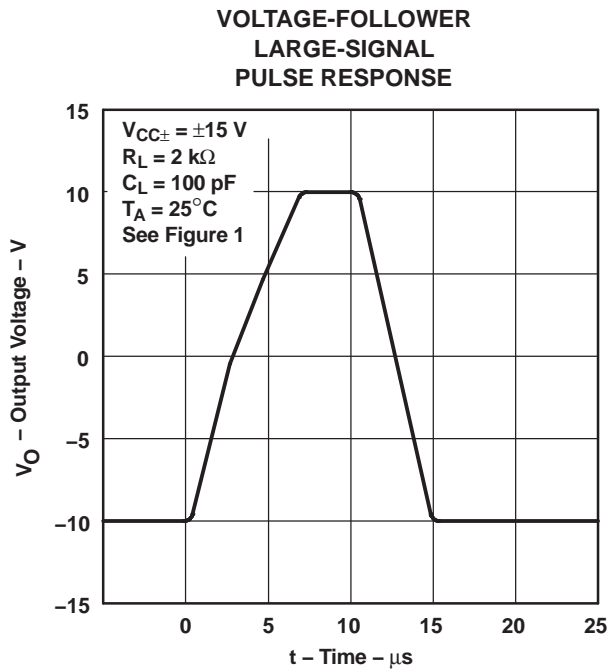

Figure 36.

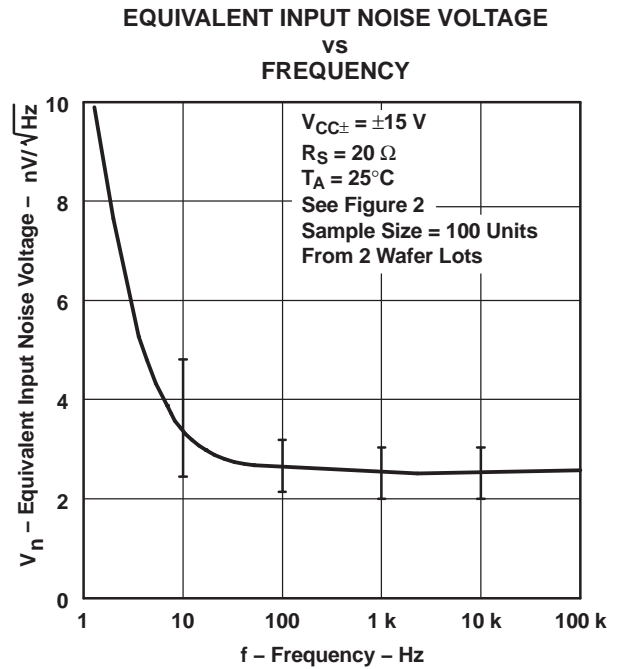

Figure 37.

TYPICAL CHARACTERISTICS (continued)

NOISE VOLTAGE
(REFERRED TO INPUT)
OVER A 10-S INTERVAL

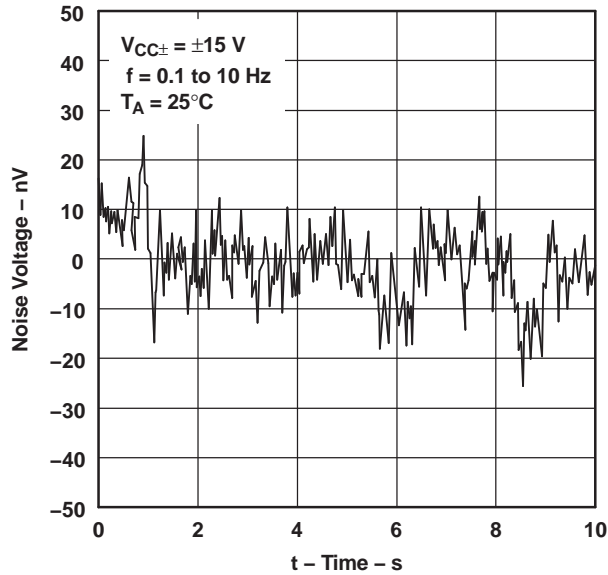

Figure 38.

UNITY-GAIN BANDWIDTH
vs
SUPPLY VOLTAGE

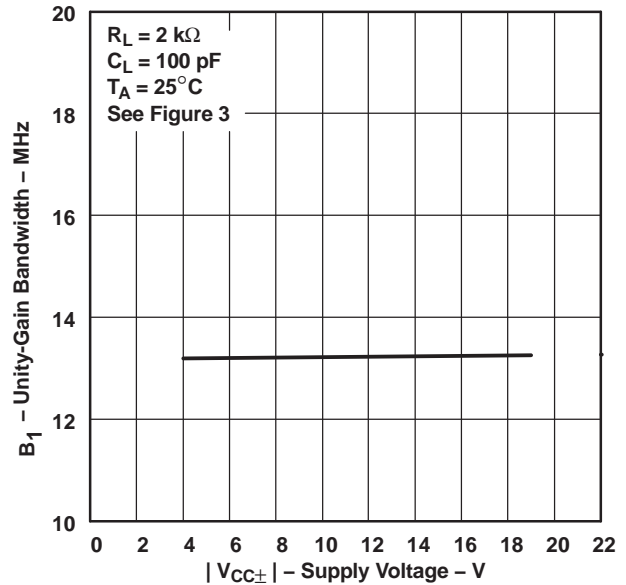

Figure 39.

UNITY-GAIN BANDWIDTH
vs
LOAD CAPACITANCE

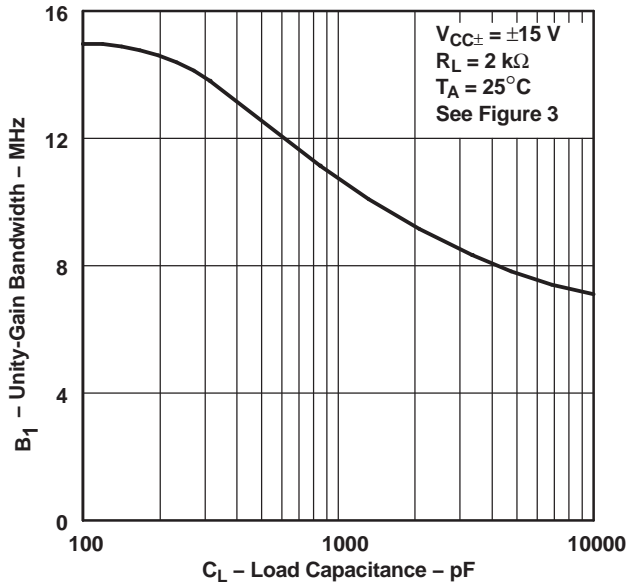

Figure 40.

SLEW RATE
vs
FREE-AIR TEMPERATURE

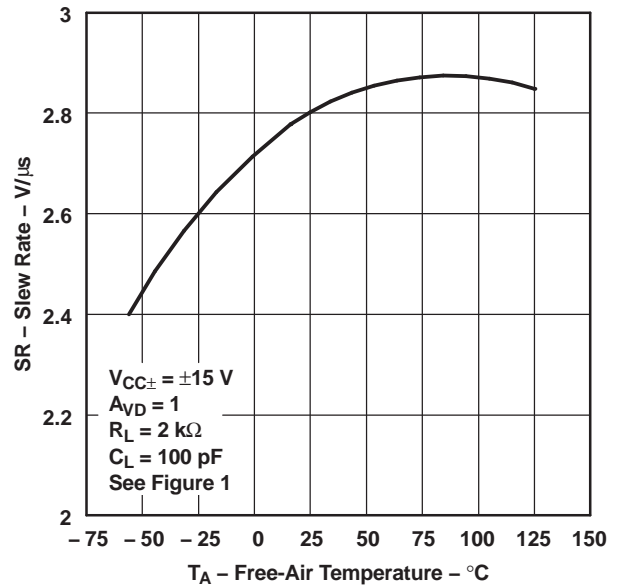

Figure 41.

NOTE A: Data at high and low temperatures are applicable only within the rated operating free-air temperature ranges of the various devices.

TYPICAL CHARACTERISTICS (continued)

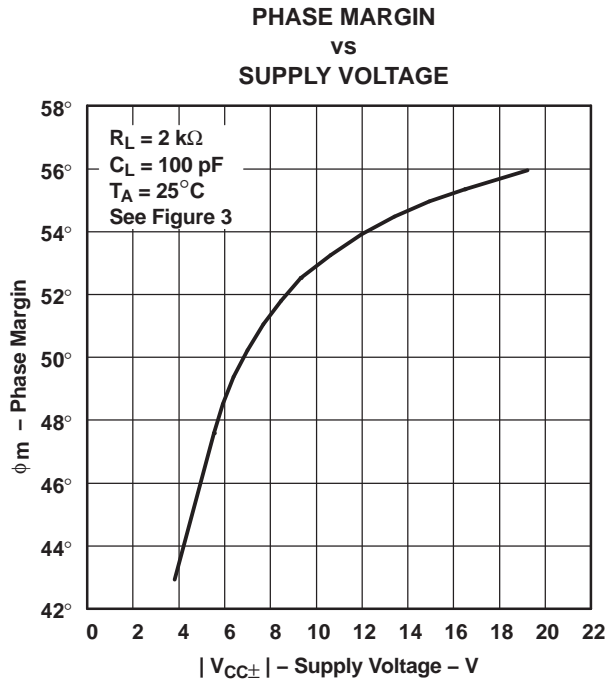

Figure 42.

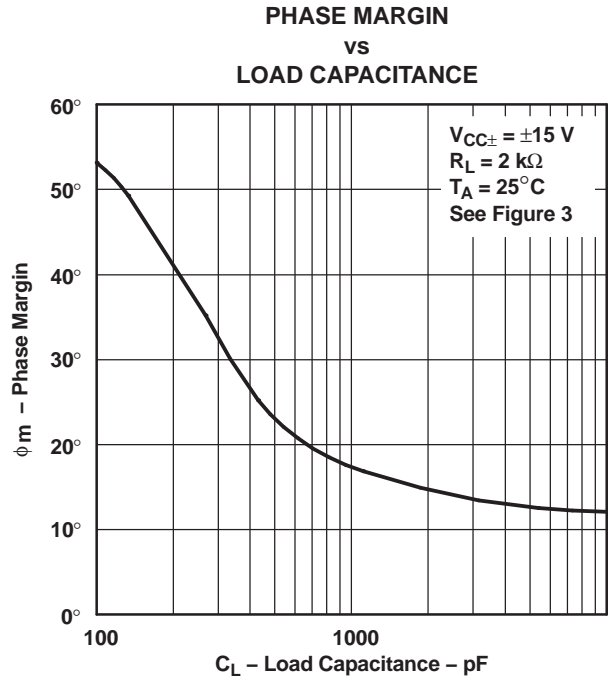
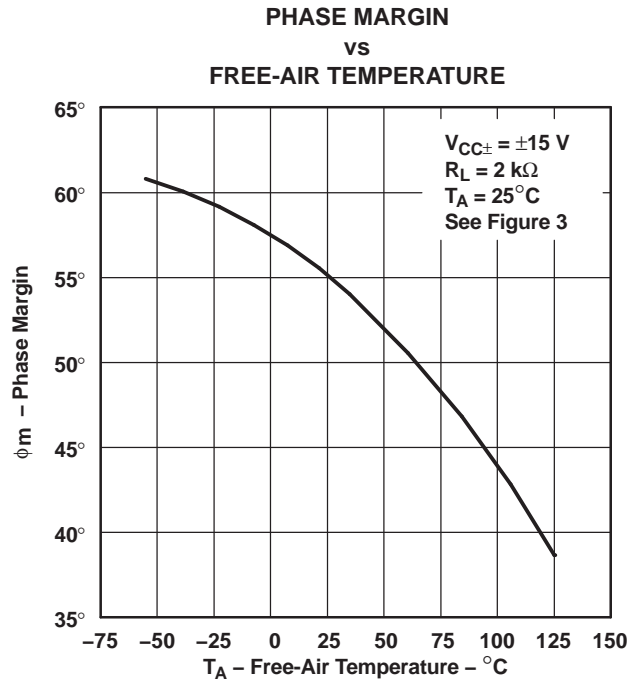

Figure 43.



NOTE A: Data at high and low temperatures are applicable only within the rated operating free-air temperature ranges of the various devices.

Figure 44.

APPLICATION INFORMATION

Input Offset Voltage Nulling

The TLE2027 series offers external null pins that can be used to further reduce the input offset voltage. The circuits of Figure 45 can be connected as shown if the feature is desired. If external nulling is not needed, the null pins may be left disconnected.

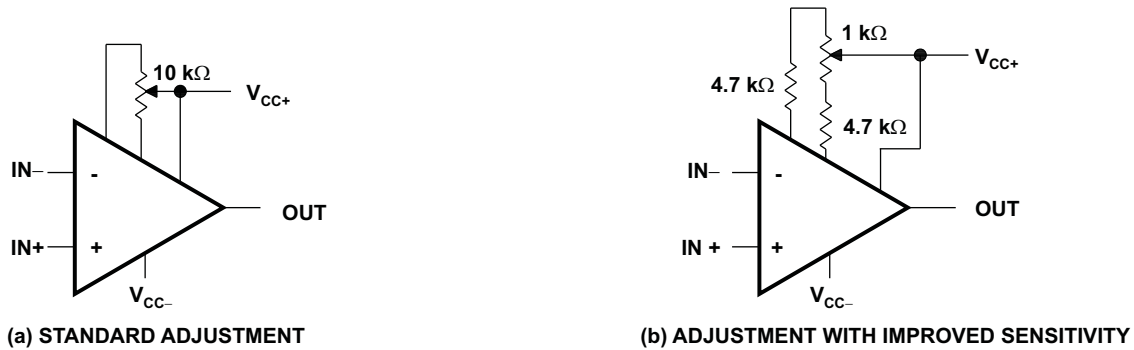

Figure 45. Input Offset Voltage Nulling Circuits

Voltage-Follower Applications

The TLE2027 circuitry includes input-protection diodes to limit the voltage across the input transistors; however, no provision is made in the circuit to limit the current if these diodes are forward biased. This condition can occur when the device is operated in the voltage-follower configuration and driven with a fast, large-signal pulse. It is recommended that a feedback resistor be used to limit the current to a maximum of 1 mA to prevent degradation of the device. Also, this feedback resistor forms a pole with the input capacitance of the device. For feedback resistor values greater than 10 kΩ, this pole degrades the amplifier phase margin. This problem can be alleviated by adding a capacitor (20 pF to 50 pF) in parallel with the feedback resistor (see Figure 46).

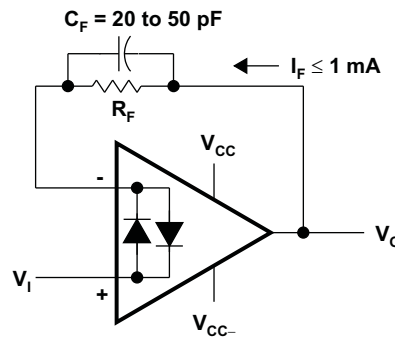

Figure 46. Voltage Follower

APPLICATION INFORMATION (continued)

Macromodel Information

Macromodel information provided was derived using Microsim Parts™, the model generation software used with Microsim PSpice™. The Boyle macromodel (see Note and Figure 47) and subcircuit (see Figure 48) were generated using the TLE202x7 typical electrical and operating characteristics at 25°C. Using this information, output simulations of the following key parameters can be generated to a tolerance of 20% (in most cases):

- Maximum positive output voltage swing
- Maximum negative output voltage swing
- Slew rate
- Quiescent power dissipation
- Input bias current
- Open-loop voltage amplification
- Gain-bandwidth product
- Common-mode rejection ratio
- Phase margin
- DC output resistance
- AC output resistance
- Short-circuit output current limit

NOTE:

G. R. Boyle, B. M. Cohn, D. O. Pederson, and J. E. Solomon, "Macromodeling of Integrated Circuit Operational Amplifiers", IEEE Journal of Solid-State Circuits, SC-9, 353 (1974).

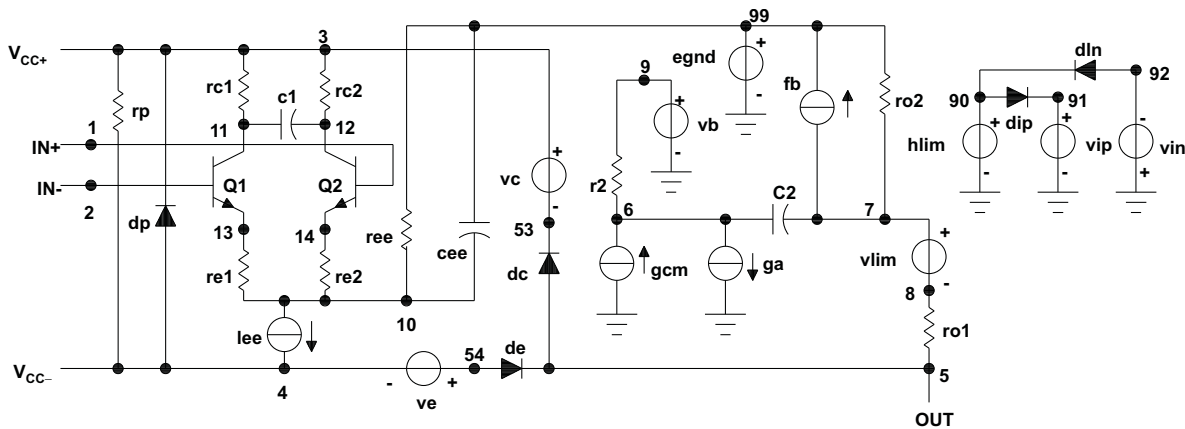

Figure 47. Boyle Macromodel

```
.subckt TLE2027 1 2 3 4 5
*
c1      11  12  4.003E-12
c2      6   7  20.00E-12
dc      5   53 dz
de      54  5  dz
dlp     90  91 dz
dln     92  90 dx
dp      4   3  dz
egnd    99  0  poly(2) (3,0)
(4,0)  0  5  .5
fb      7   99 poly(5) vb vc ve
vlp vln 0 954.8E6 -1E9 1E9 1E9 -1E9
ga      6   0  11  12
2.062E-3
gcm     0   6  10  99
531.3E-12
iee     10  4  dc 56.01E-6
hlim    90  0  vlim 1K
ql      11  2  13 qx
q2      12  1  14 qx
r2      6   9  100.0E3
rc1     3  11  530.5
rc2     3  12  530.5
re1     13  10 -393.2
re2     14  10 -393.2
ree     10  99 3.571E6
ro1     8   5  25
ro2     7  99  25
rp      3   4  8.013E3
vb      9   0  dc 0
vc      3  53  dc 2.400
ve     54  4  dc 2.100
vlim    7   8  dc 0
vlp     91  0  dc 40
vln     0  92  dc 40
.modeldx D(Is=800.0E-18)
.modelqx NPN(Is=800.0E-18
Bf=7.000E3)
.ends
```

Figure 48. TLE2027 Macromodel Subcircuit

PACKAGING INFORMATION

Orderable part number	Status (1)	Material type (2)	Package Pins	Package qty Carrier	RoHS (3)	Lead finish/ Ball material (4)	MSL rating/ Peak reflow (5)	Op temp (°C)	Part marking (6)
TLE2027MDREP	Active	Production	SOIC (D) 8	2500 LARGE T&R	Yes	NIPDAU	Level-1-260C-UNLIM	-55 to 125	2027EP
TLE2027MDREP.A	Active	Production	SOIC (D) 8	2500 LARGE T&R	Yes	NIPDAU	Level-1-260C-UNLIM	-55 to 125	2027EP
V62/06674-01XE	Active	Production	SOIC (D) 8	2500 LARGE T&R	Yes	NIPDAU	Level-1-260C-UNLIM	-55 to 125	2027EP

(1) **Status:** For more details on status, see our [product life cycle](#).

(2) **Material type:** When designated, preproduction parts are prototypes/experimental devices, and are not yet approved or released for full production. Testing and final process, including without limitation quality assurance, reliability performance testing, and/or process qualification, may not yet be complete, and this item is subject to further changes or possible discontinuation. If available for ordering, purchases will be subject to an additional waiver at checkout, and are intended for early internal evaluation purposes only. These items are sold without warranties of any kind.

(3) **RoHS values:** Yes, No, RoHS Exempt. See the [TI RoHS Statement](#) for additional information and value definition.

(4) **Lead finish/Ball material:** Parts may have multiple material finish options. Finish options are separated by a vertical ruled line. Lead finish/Ball material values may wrap to two lines if the finish value exceeds the maximum column width.

(5) **MSL rating/Peak reflow:** The moisture sensitivity level ratings and peak solder (reflow) temperatures. In the event that a part has multiple moisture sensitivity ratings, only the lowest level per JEDEC standards is shown. Refer to the shipping label for the actual reflow temperature that will be used to mount the part to the printed circuit board.

(6) **Part marking:** There may be an additional marking, which relates to the logo, the lot trace code information, or the environmental category of the part.

Multiple part markings will be inside parentheses. Only one part marking contained in parentheses and separated by a "-" will appear on a part. If a line is indented then it is a continuation of the previous line and the two combined represent the entire part marking for that device.

Important Information and Disclaimer: The information provided on this page represents TI's knowledge and belief as of the date that it is provided. TI bases its knowledge and belief on information provided by third parties, and makes no representation or warranty as to the accuracy of such information. Efforts are underway to better integrate information from third parties. TI has taken and continues to take reasonable steps to provide representative and accurate information but may not have conducted destructive testing or chemical analysis on incoming materials and chemicals. TI and TI suppliers consider certain information to be proprietary, and thus CAS numbers and other limited information may not be available for release.

In no event shall TI's liability arising out of such information exceed the total purchase price of the TI part(s) at issue in this document sold by TI to Customer on an annual basis.

OTHER QUALIFIED VERSIONS OF TLE2027-EP :

- Catalog : [TLE2027](#)

- Military : [TLE2027M](#)

NOTE: Qualified Version Definitions:

- Catalog - TI's standard catalog product
- Military - QML certified for Military and Defense Applications

TAPE AND REEL INFORMATION

QUADRANT ASSIGNMENTS FOR PIN 1 ORIENTATION IN TAPE

*All dimensions are nominal

Device	Package Type	Package Drawing	Pins	SPQ	Reel Diameter (mm)	Reel Width W1 (mm)	A0 (mm)	B0 (mm)	K0 (mm)	P1 (mm)	W (mm)	Pin1 Quadrant
TLE2027MDREP	SOIC	D	8	2500	330.0	12.4	6.4	5.2	2.1	8.0	12.0	Q1

TAPE AND REEL BOX DIMENSIONS



*All dimensions are nominal

Device	Package Type	Package Drawing	Pins	SPQ	Length (mm)	Width (mm)	Height (mm)
TLE2027MDREP	SOIC	D	8	2500	353.0	353.0	32.0



D0008A

PACKAGE OUTLINE

SOIC - 1.75 mm max height

SMALL OUTLINE INTEGRATED CIRCUIT



NOTES:

1. Linear dimensions are in inches [millimeters]. Dimensions in parenthesis are for reference only. Controlling dimensions are in inches. Dimensioning and tolerancing per ASME Y14.5M.
2. This drawing is subject to change without notice.
3. This dimension does not include mold flash, protrusions, or gate burrs. Mold flash, protrusions, or gate burrs shall not exceed $.006$ [0.15] per side.
4. This dimension does not include interlead flash.
5. Reference JEDEC registration MS-012, variation AA.

EXAMPLE BOARD LAYOUT

D0008A

SOIC - 1.75 mm max height

SMALL OUTLINE INTEGRATED CIRCUIT



LAND PATTERN EXAMPLE
 EXPOSED METAL SHOWN
 SCALE:8X



SOLDER MASK DETAILS

4214825/C 02/2019

NOTES: (continued)

- 6. Publication IPC-7351 may have alternate designs.
- 7. Solder mask tolerances between and around signal pads can vary based on board fabrication site.

EXAMPLE STENCIL DESIGN

D0008A

SOIC - 1.75 mm max height

SMALL OUTLINE INTEGRATED CIRCUIT



SOLDER PASTE EXAMPLE
BASED ON .005 INCH [0.125 MM] THICK STENCIL
SCALE:8X

4214825/C 02/2019

NOTES: (continued)

8. Laser cutting apertures with trapezoidal walls and rounded corners may offer better paste release. IPC-7525 may have alternate design recommendations.
9. Board assembly site may have different recommendations for stencil design.

IMPORTANT NOTICE AND DISCLAIMER

TI PROVIDES TECHNICAL AND RELIABILITY DATA (INCLUDING DATASHEETS), DESIGN RESOURCES (INCLUDING REFERENCE DESIGNS), APPLICATION OR OTHER DESIGN ADVICE, WEB TOOLS, SAFETY INFORMATION, AND OTHER RESOURCES "AS IS" AND WITH ALL FAULTS, AND DISCLAIMS ALL WARRANTIES, EXPRESS AND IMPLIED, INCLUDING WITHOUT LIMITATION ANY IMPLIED WARRANTIES OF MERCHANTABILITY, FITNESS FOR A PARTICULAR PURPOSE OR NON-INFRINGEMENT OF THIRD PARTY INTELLECTUAL PROPERTY RIGHTS.

These resources are intended for skilled developers designing with TI products. You are solely responsible for (1) selecting the appropriate TI products for your application, (2) designing, validating and testing your application, and (3) ensuring your application meets applicable standards, and any other safety, security, regulatory or other requirements.

These resources are subject to change without notice. TI grants you permission to use these resources only for development of an application that uses the TI products described in the resource. Other reproduction and display of these resources is prohibited. No license is granted to any other TI intellectual property right or to any third party intellectual property right. TI disclaims responsibility for, and you fully indemnify TI and its representatives against any claims, damages, costs, losses, and liabilities arising out of your use of these resources.

TI's products are provided subject to [TI's Terms of Sale](#), [TI's General Quality Guidelines](#), or other applicable terms available either on [ti.com](#) or provided in conjunction with such TI products. TI's provision of these resources does not expand or otherwise alter TI's applicable warranties or warranty disclaimers for TI products. Unless TI explicitly designates a product as custom or customer-specified, TI products are standard, catalog, general purpose devices.

TI objects to and rejects any additional or different terms you may propose.

Copyright © 2025, Texas Instruments Incorporated

Last updated 10/2025