

# TLE202xM Excalibur, High-Speed, Low-Power, Precision, Operational Amplifiers

## 1 Features

- Supply current: 300 $\mu$ A, max
- High unity-gain bandwidth: 2MHz
- High slew rate: 0.65V/ $\mu$ s
- Supply-current change over military temperature range: 10 $\mu$ A at  $V_S = \pm 15$ V
- Specified for both 5V single-supply and  $\pm 15$ V operation
- Phase-reversal protection
- High open-loop gain: 6.5V/ $\mu$ V (136dB)
- Low offset voltage: 100 $\mu$ V, max
- Offset voltage drift with time: 0.005 $\mu$ V/mo
- Low input bias current: 50nA, max
- Low noise voltage: 19nV/ $\sqrt{\text{Hz}}$

## 2 Description

The TLE2021xM, TLE2022xM, and TLE2024xM (TLE202xM) devices are precision, high-speed, low-power operational amplifiers using a new Texas Instruments Excalibur process. These devices combine the best features of the OP21, with a highly improved slew rate and unity-gain bandwidth.

The complementary bipolar Excalibur process uses isolated vertical pnp transistors that yield dramatic improvement in unity-gain bandwidth and slew rate over similar devices.

The addition of a bias circuit in conjunction with this process results in extremely stable parameters with both time and temperature. Therefore, a precision device remains a precision device even with changes in temperature and over years of use.

This combination of excellent dc performance with a common-mode input voltage range that includes the negative rail makes these devices an excellent choice for low-level signal conditioning applications in either single-supply or split-supply configurations. In addition, these devices offer phase-reversal protection circuitry that eliminates an unexpected change in output states when one of the inputs is less than the negative supply rail.

A variety of available options includes ceramic DIP and chip-carrier versions for high-density systems applications.

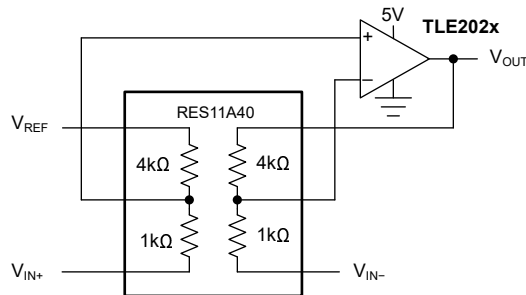
The M-suffix devices are characterized for operation over the full military temperature range of  $-55^{\circ}\text{C}$  to  $+125^{\circ}\text{C}$ .

### Device Information

PART NUMBER <sup>(1)</sup>	CHANNEL COUNT	PACKAGE <sup>(2)</sup>
TLE2021xM	Single	FK (LCCC, 20)
		JG (CDIP, 8)
TLE2022xM	Dual	FK (LCCC, 20)
		JG (CDIP, 8)
TLE2024xM	Quad	FK (LCCC, 20)
		J (CDIP, 14)

(1) See [Section 3](#).

(2) For more information, see [Section 11](#).



**Difference Amplifier Circuit With the RES11A**



## Table of Contents

<b>1 Features</b> .....	1	5.13 Operating Characteristics TLE2024M, $V_{CC} = 5\text{ V}$ .....	9
<b>2 Description</b> .....	1	5.14 Electrical Characteristics TLE2024xM, $V_{CC} =$ $\pm 15\text{ V}$ .....	10
<b>3 Device Comparison Tables</b> .....	2	5.15 Operating Characteristics TLE2024M, $V_{CC} =$ $\pm 15\text{ V}$ .....	10
<b>4 Pin Configuration and Functions</b> .....	3	5.16 Typical Characteristics.....	11
<b>5 Specifications</b> .....	4	<b>6 Parameter Measurement Information</b> .....	23
5.1 Absolute Maximum Ratings.....	4	6.1 Typical Values.....	24
5.2 Dissipation Ratings.....	4	<b>7 Detailed Description</b> .....	25
5.3 Recommended Operating Conditions.....	4	7.1 Functional Block Diagram.....	25
5.4 Electrical Characteristics TLE2021xM, $V_{CC} = 5\text{ V}$ .....	5	<b>8 Application and Implementation</b> .....	26
5.5 Operating Characteristics TLE2021M, $V_{CC} = 5\text{ V}$ .....	5	8.1 Application Information.....	26
5.6 Electrical Characteristics TLE2021xM, $V_{CC} =$ $\pm 15\text{ V}$ .....	6	<b>9 Device and Documentation Support</b> .....	29
5.7 Operating Characteristics TLE2021M, $V_{CC} = \pm 15$ $\text{V}$ .....	6	9.1 Receiving Notification of Documentation Updates....	29
5.8 Electrical Characteristics TLE2022xM, $V_{CC} = 5\text{ V}$ .....	7	9.2 Support Resources.....	29
5.9 Operating Characteristics TLE2022M, $V_{CC} = 5\text{ V}$ .....	7	9.3 Trademarks.....	29
5.10 Electrical Characteristics TLE2022xM, $V_{CC} =$ $\pm 15\text{ V}$ .....	8	9.4 Electrostatic Discharge Caution.....	29
5.11 Operating Characteristics TLE2022M, $V_{CC} =$ $\pm 15\text{ V}$ .....	8	9.5 Glossary.....	29
5.12 Electrical Characteristics TLE2024xM, $V_{CC} = 5\text{ V}$ ....	9	<b>10 Revision History</b> .....	29
		<b>11 Mechanical, Packaging, and Orderable Information</b> .....	29

## 3 Device Comparison Tables

**Table 3-1. TLE2021xM Available Options**

$T_A$	PACKAGED DEVICES		
	$V_{IOmax}$ AT 25°C	CHIP CARRIER (FK)	CERAMIC DIP (JG)
-55°C to +125°C	100 $\mu\text{V}$ 500 $\mu\text{V}$	TLE2021BMFK TLE2021MFK	TLE2021BMJG TLE2021MJG

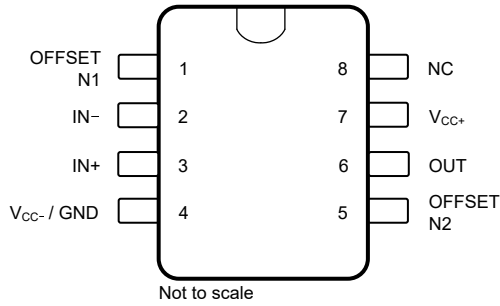
**Table 3-2. TLE2022xM Available Options**

$T_A$	PACKAGED DEVICES		
	$V_{IOmax}$ AT 25°C	CHIP CARRIER (FK)	CERAMIC DIP (JG)
-55°C to +125°C	150 $\mu\text{V}$ 300 $\mu\text{V}$ 500 $\mu\text{V}$	— TLE2022AMFK TLE2022MFK	TLE2022BMJG TLE2022AMJG TLE2022MJG

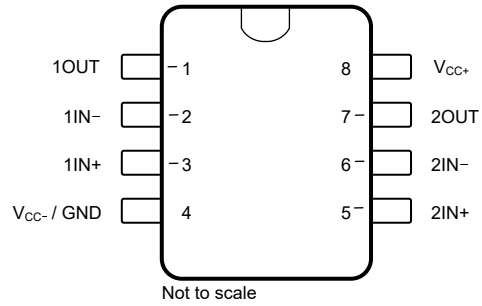
**Table 3-3. TLE2024xM Available Options**

$T_A$	PACKAGED DEVICES		
	$V_{IOmax}$ AT 25°C	CHIP CARRIER (FK)	CERAMIC DIP (J)
-55°C to +125°C	500 $\mu\text{V}$ 750 $\mu\text{V}$ 1000 $\mu\text{V}$	TLE2024BMFK TLE2024AMFK TLE2024MFK	TLE2024BMJ TLE2024AMJ TLE2024MJ

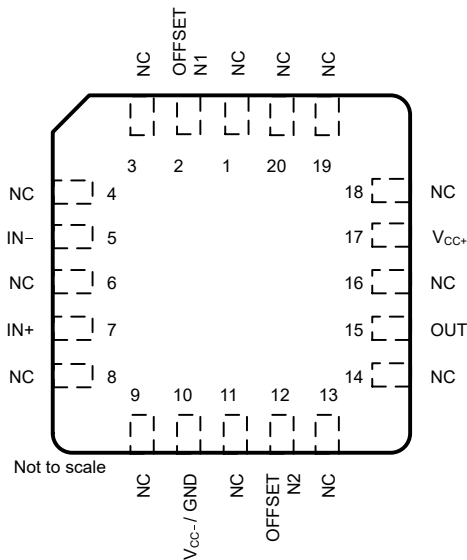
### 4 Pin Configuration and Functions



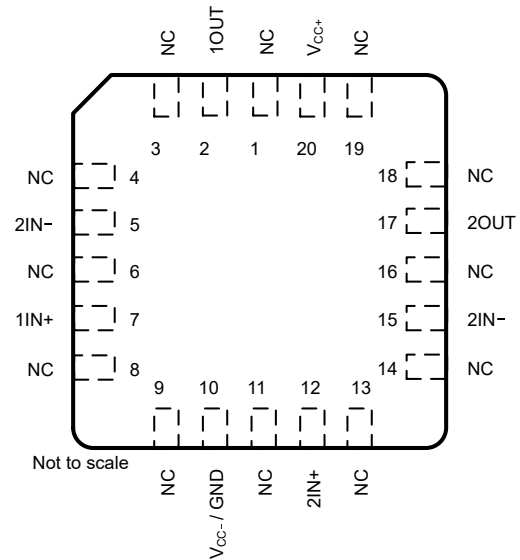
**Figure 4-1. TLE2021xM: JG Package, 8-Pin CDIP (Top View)**



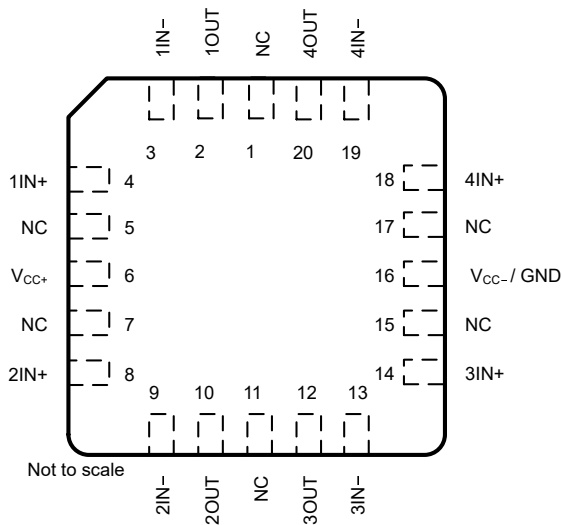
**Figure 4-2. TLE2022xM: JG Package, 8-Pin CDIP (Top View)**



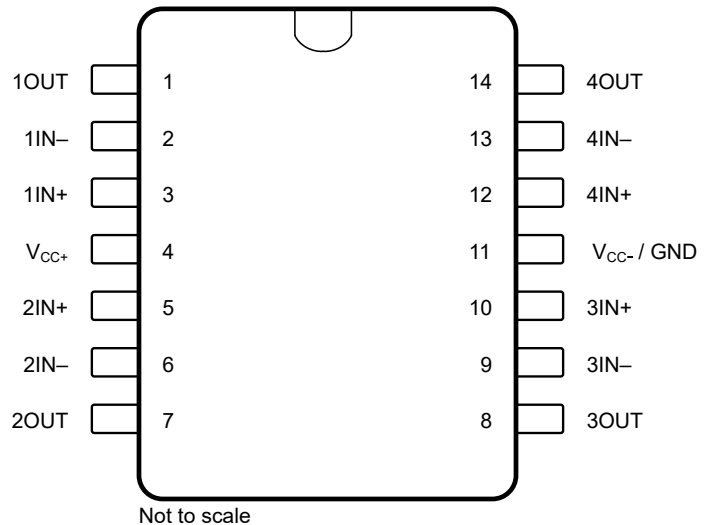
**Figure 4-3. TLE2021xM: FK Package, 20-Pin LCCC (Top View)**



**Figure 4-4. TLE2022xM: FK Package, 20-Pin LCCC (Top View)**



**Figure 4-5. TLE2024xM: FK Package, 20-Pin LCCC (Top View)**



**Figure 4-6. TLE2024xM: J Package, 14-Pin CDIP (Top View)**

## 5 Specifications

### 5.1 Absolute Maximum Ratings

over operating free-air temperature range (unless otherwise noted) <sup>(1)</sup>

		VALUE	UNIT
Supply voltage, $V_{CC+}$ <sup>(2)</sup>		20	V
Supply voltage, $V_{CC-}$ <sup>(2)</sup>		-20	V
Differential input voltage, $V_{ID}$ <sup>(3)</sup>		$\pm 0.6$	V
Input voltage range, $V_I$ (any input) <sup>(2)</sup>		$\pm V_{CC}$	
Input current, $I_I$ (each input)		$\pm 1$	mA
Output current, $I_O$ (each output):	TLE2021	$\pm 20$	mA
	TLE2022	$\pm 30$	
	TLE2024	$\pm 40$	
Total current into $V_{CC+}$		80	mA
Total current out of $V_{CC-}$		80	mA
Duration of short-circuit current at (or below) 25°C <sup>(4)</sup>		Unlimited	
Continuous total power dissipation		See <i>Dissipation Ratings</i>	
Operating free-air temperature range, $T_A$		-55 to 125	°C
Storage temperature range, $T_{stg}$		-65 to 150	°C
Case temperature for 60 seconds, $T_C$ : FK package		260	°C
Lead temperature 1,6 mm (1/16 inch) from case for 60 seconds: JG package		300	°C

- Stresses beyond those listed under *Absolute Maximum Ratings* may cause permanent damage to the device. These are stress ratings only, and functional operation of the device at these or any other conditions beyond those indicated under *Recommended Operating Conditions* is not implied. Exposure to absolute-maximum-rated conditions for extended periods may affect device reliability.
- All voltage values, except differential voltages, are with respect to the midpoint between  $V_{CC+}$ , and  $V_{CC-}$ .
- Differential voltages are at  $IN+$  with respect to  $IN-$ . Excessive current flows if a differential input voltage in excess of approximately  $\pm 600$  mV is applied between the inputs unless some limiting resistance is used.
- The output is able to be shorted to either supply. Limit temperature, supply voltages, or both to not exceed the maximum dissipation ratings.

### 5.2 Dissipation Ratings

PACKAGE	$T_A \leq 25^\circ\text{C}$ POWER RATING	DERATING FACTOR ABOVE $T_A = 25^\circ\text{C}$	$T_A = 70^\circ\text{C}$ POWER RATING	$T_A = 85^\circ\text{C}$ POWER RATING	$T_A = 125^\circ\text{C}$ POWER RATING
FK	1375 mW	11.0 mW/°C	880 mW	715 mW	275 mW
J-14	1375 mW	11.0 mW/°C	880 mW	715 mW	275 mW
JG-8	1050 mW	8.4 mW/°C	672 mW	546 mW	210 mW

### 5.3 Recommended Operating Conditions

over operating free-air temperature range (unless otherwise noted)

	M SUFFIX		UNIT
	MIN	MAX	
Supply voltage, $V_{CC}$	$\pm 2$	$\pm 20$	V
Common-mode input voltage, $V_{IC}$	$V_{CC} = \pm 5$ V	0	V
	$V_{CC} \pm = \pm 15$ V	-15	
Operating free-air temperature, $T_A$	-55	125	°C

## 5.4 Electrical Characteristics TLE2021xM, $V_{CC} = 5\text{ V}$

at specified free-air temperature and  $V_{CC} = 5\text{ V}$  (unless otherwise noted)

PARAMETER		TEST CONDITIONS	$T_A$ <sup>(1)</sup>	TLE2021M			TLE2021BM			UNIT
				MIN	TYP	MAX	MIN	TYP	MAX	
$V_{IO}$	Input offset voltage	$V_{IC} = 0, R_S = 50\ \Omega$	25°C	120		600	80		200	$\mu\text{V}$
			Full range	1100			300			
$\alpha_{VIO}$	Temperature coefficient of input offset voltage		Full range	2			2			$\mu\text{V}/^\circ\text{C}$
	Input offset voltage long-term drift <sup>(2)</sup>		25°C	0.005			0.005			$\mu\text{V}/\text{mo}$
$I_{IO}$	Input offset current		25°C	0.2		6	0.2		6	nA
			Full range	10			10			
$I_{IB}$	Input bias current	25°C	25		70	25		70	nA	
		Full range	90			90				
$V_{ICR}$	Common-mode input voltage range	$R_S = 50\ \Omega$	25°C	0 to 3.5	-0.3 to 4		0 to 3.5	-0.3 to 4	V	
			Full range	0 to 3.2		0 to 3.2				
$V_{OH}$	High-level output voltage	$R_L = 10\ \text{k}\Omega$	25°C	4	4.3		4	4.3	V	
			Full range	3.8		3.8				
$V_{OL}$	Low-level output voltage		25°C	0.7		0.8	0.7		0.8	V
			Full range	0.95			0.95			
$A_{VD}$	Large-signal differential voltage amplification	$V_O = 1.4\text{ V to }4\text{ V}, R_L = 10\ \text{k}\Omega$	25°C	0.3	1.5		0.3	1.5	V/ $\mu\text{V}$	
			Full range	0.1		0.1				
CMRR	Common mode rejection ratio	$V_{IC} = V_{ICRmin}, R_S = 50\ \Omega$	25°C	85	110		85	110	dB	
			Full range	80		80				
$k_{SVR}$	Supply-voltage rejection ratio ( $\Delta V_{CC}/\Delta V_{IO}$ )	$V_{CC} = 5\text{ V to }30\text{ V}$	25°C	105	120		105	120	dB	
			Full range	100		100				
$I_{CC}$	Supply current	$V_O = 2.5\text{ V}, \text{ no load}$	25°C	170		230	170		230	$\mu\text{A}$
			Full range	230			230			
$\Delta I_{CC}$	Supply-current change over operating temperature range		Full range	9		9				$\mu\text{A}$

(1) Full range is  $-55^\circ\text{C}$  to  $+125^\circ\text{C}$ .

(2) Typical values are based on the input offset voltage shift observed through 168 hours of operating life test at  $T_A = 150^\circ\text{C}$  extrapolated to  $T_A = 25^\circ\text{C}$  using the Arrhenius equation and assuming an activation energy of 0.96 eV.

## 5.5 Operating Characteristics TLE2021M, $V_{CC} = 5\text{ V}$

at  $T_A = 25^\circ\text{C}$  and  $V_{CC} = 5\text{ V}$  (unless otherwise noted)

PARAMETER		TEST CONDITIONS	$T_A$	M SUFFIX			UNIT
				MIN	TYP	MAX	
SR	Slew rate at unity gain	$V_O = 1\text{ V to }3\text{ V}$ , see <a href="#">Figure 6-1</a>	25°C	0.5			V/ $\mu\text{s}$
$V_n$	Equivalent input noise voltage (see <a href="#">Figure 6-2</a> )	$f = 10\text{ Hz}$	25°C	21			nV/ $\sqrt{\text{Hz}}$
		$f = 1\text{ kHz}$	25°C	17			
$V_{N(PP)}$	Peak-to-peak equivalent input noise voltage	$f = 0.1\text{ Hz to }1\text{ Hz}$	25°C	0.16			$\mu\text{V}$
		$f = 0.1\text{ Hz to }10\text{ Hz}$	25°C	0.47			
$I_n$	Equivalent input noise current		25°C	0.9			pA/ $\sqrt{\text{Hz}}$
$B_1$	Unity-gain bandwidth	See <a href="#">Figure 6-3</a>	25°C	1.2			MHz
$\Phi_m$	Phase margin at unity gain	See <a href="#">Figure 6-3</a>	25°C	42°			

## 5.6 Electrical Characteristics TLE2021xM, $V_{CC} = \pm 15\text{ V}$

at specified free-air temperature and  $V_{CC} = \pm 15\text{ V}$  (unless otherwise noted)

PARAMETER		TEST CONDITIONS	$T_A$ <sup>(1)</sup>	TLE2021M			TLE2021BM			UNIT
				MIN	TYP	MAX	MIN	TYP	MAX	
$V_{IO}$	Input offset voltage		25°C	120		500	40		100	$\mu\text{V}$
			Full range	1000			200			
$\alpha_{VIO}$	Temperature coefficient of input offset voltage		Full range	2		2			$\mu\text{V}/^\circ\text{C}$	
	Input offset voltage long-term drift <sup>(2)</sup>	$V_{IC} = 0, R_S = 50\ \Omega$	25°C	0.006		0.006			$\mu\text{V}/\text{mo}$	
$I_{IO}$	Input offset current		25°C	0.2		6	0.2		6	nA
			Full range	10			10			
$I_{IB}$	Input bias current		25°C	25		70	25		70	nA
			Full range	90			90			
$V_{ICR}$	Common-mode input voltage range	$R_S = 50\ \Omega$	25°C	-15 to 13.5	-15.3 to 14		-15 to 13.5	-15.3 to 14		V
			Full range	-15 to 13.2		-15 to 13.2				
$V_{OM+}$	Maximum positive peak output voltage swing	$R_L = 10\ \text{k}\Omega$	25°C	14	14.3		14	14.3		V
			Full range	13.8			13.8			
$V_{OM-}$	Maximum negative peak output voltage swing	$R_L = 10\ \text{k}\Omega$	25°C	-13.7	-14.1		-13.7	-14.1		V
			Full range	-13.6			-13.6			
$A_{VD}$	Large-signal differential voltage amplification	$V_O = \pm 10\ \text{V}, R_L = 10\ \text{k}\Omega$	25°C	1	6.5		1	6.5		$\text{V}/\mu\text{V}$
			Full range	0.5			0.5			
CMRR	Common mode rejection ratio	$V_{IC} = V_{ICRmin}, R_S = 50\ \Omega$	25°C	100	115		100	115		dB
			Full range	96			96			
$k_{SVR}$	Supply-voltage rejection ratio ( $\Delta V_{CC}/\Delta V_{IO}$ )	$V_{CC} = \pm 2.5\ \text{V}$ to $\pm 15\ \text{V}$	25°C	105	120		105	120		dB
			Full range	100			100			
$I_{CC}$	Supply current	$V_O = 0, \text{no load}$	25°C	200		300	200		300	$\mu\text{A}$
			Full range	300			300			
$\Delta I_{CC}$	Supply-current change over operating temperature range		Full range	10		10			$\mu\text{A}$	

(1) Full range is  $-55^\circ\text{C}$  to  $+125^\circ\text{C}$ .

(2) Typical values are based on the input offset voltage shift observed through 168 hours of operating life test at  $T_A = 150^\circ\text{C}$  extrapolated to  $T_A = 25^\circ\text{C}$  using the Arrhenius equation and assuming an activation energy of 0.96 eV.

## 5.7 Operating Characteristics TLE2021M, $V_{CC} = \pm 15\text{ V}$

at specified free-air temperature and  $V_{CC} = \pm 15\text{ V}$  (unless otherwise noted)

PARAMETER		TEST CONDITIONS	$T_A$ <sup>(1)</sup>	M SUFFIX			UNIT
				MIN	TYP	MAX	
SR	Slew rate at unity gain	$V_O = 1\ \text{V}$ to $3\ \text{V}$ , see <a href="#">Figure 6-1</a>	25°C	0.45	0.65		$\text{V}/\mu\text{s}$
			Full range	0.42			
$V_n$	Equivalent input noise voltage (see <a href="#">Figure 6-2</a> )	$f = 10\ \text{Hz}$	25°C	19			$\text{nV}/\sqrt{\text{Hz}}$
		$f = 1\ \text{kHz}$	25°C	15			
$V_{N(PP)}$	Peak-to-peak equivalent input noise voltage	$f = 0.1\ \text{Hz}$ to $1\ \text{Hz}$	25°C	0.16			$\mu\text{V}$
		$f = 0.1\ \text{Hz}$ to $10\ \text{Hz}$	25°C	0.47			
$I_n$	Equivalent input noise current		25°C	0.9			$\text{pA}/\sqrt{\text{Hz}}$
$B_1$	Unity-gain bandwidth	See <a href="#">Figure 6-3</a>	25°C	1.2			MHz
$\phi_m$	Phase margin at unity gain	See <a href="#">Figure 6-3</a>	25°C	46°			

(1) Full range is  $-55^\circ\text{C}$  to  $+125^\circ\text{C}$ .

## 5.8 Electrical Characteristics TLE2022xM, $V_{CC} = 5\text{ V}$

at specified free-air temperature and  $V_{CC} = 5\text{ V}$  (unless otherwise noted)

PARAMETER		TEST CONDITIONS	$T_A$ (1)	TLE2022M			TLE2022AM			TLE2022BM			UNIT	
				MIN	TYP	MAX	MIN	TYP	MAX	MIN	TYP	MAX		
$V_{IO}$	Input offset voltage	$V_{IC} = 0, R_S = 50\ \Omega$	25°C	600			400			250			$\mu\text{V}$	
			Full range	800			550			400				
$\alpha_{V_{IO}}$	Temperature coefficient of input offset voltage		Full range	2			2			2			$\mu\text{V}/^\circ\text{C}$	
	Input offset voltage long-term drift(2)		25°C	0.005			0.005			0.005			$\mu\text{V}/\text{mo}$	
$I_{IO}$	Input offset current		25°C	0.5 6			0.4 6			0.3 6			nA	
			Full range	10			10			10				
$I_{IB}$	Input bias current	25°C	35 70			33 70			30 70			nA		
		Full range	90			90			90					
$V_{ICR}$	Common-mode input voltage range	$R_S = 50\ \Omega$	25°C	0 to 3.5 -0.3 to 4			0 to 3.5 -0.3 to 4			0 to 3.5 -0.3 to 4			V	
			Full range	0 to 3.2			0 to 3.2			0 to 3.2				
$V_{OH}$	High-level output voltage		25°C	4 4.3			4 4.3			4 4.3			V	
			Full range	3.8			3.8			3.8				
$V_{OL}$	Low-level output voltage		25°C	0.7 0.8			0.7 0.8			0.7 0.8			V	
			Full range	0.95			0.95			0.95				
$A_{VD}$	Large-signal differential voltage amplification	$V_O = 1.4\text{ V to }4\text{ V}, R_L = 10\text{ k}\Omega$	25°C	0.3 1.5			0.4 1.5			0.5 1.5			$\text{V}/\mu\text{V}$	
			Full range	0.1			0.1			0.1				
CMRR	Common mode rejection ratio		25°C	85 100			87 102			90 105			dB	
			Full range	80			82			85				
$k_{SVR}$	Supply-voltage rejection ratio ( $\Delta V_{CC}/\Delta V_{IO}$ )		$V_{CC} = 5\text{ V to }30\text{ V}$	25°C	100 115			103 118			105 120			dB
				Full range	95			98			100			
$I_{CC}$	Supply current	25°C		450 600			450 600			450 600			$\mu\text{A}$	
		Full range		600			600			600				
$\Delta I_{CC}$	Supply-current change over operating temperature range	Full range		37			37			37			$\mu\text{A}$	

(1) Full range is  $-55^\circ\text{C}$  to  $+125^\circ\text{C}$ .

(2) Typical values are based on the input offset voltage shift observed through 168 hours of operating life test at  $T_A = 150^\circ\text{C}$  extrapolated to  $T_A = 25^\circ\text{C}$  using the Arrhenius equation and assuming an activation energy of 0.96 eV.

## 5.9 Operating Characteristics TLE2022M, $V_{CC} = 5\text{ V}$

at  $T_A = 25^\circ\text{C}$  and  $V_{CC} = 5\text{ V}$  (unless otherwise noted)

PARAMETER		TEST CONDITIONS	$T_A$	M SUFFIX			UNIT
				MIN	TYP	MAX	
SR	Slew rate at unity gain	$V_O = 1\text{ V to }3\text{ V}$ , see <a href="#">Figure 6-1</a>	25°C	0.5			$\text{V}/\mu\text{s}$
$V_n$	Equivalent input noise voltage (see <a href="#">Figure 6-2</a> )	$f = 10\text{ Hz}$	25°C	21			$\text{nV}/\text{Hz}$
		$f = 1\text{ kHz}$	25°C	17			
$V_{N(\text{PP})}$	Peak-to-peak equivalent input noise voltage	$f = 0.1\text{ Hz to }1\text{ Hz}$	25°C	0.16			$\mu\text{V}$
		$f = 0.1\text{ Hz to }10\text{ Hz}$	25°C	0.47			
$I_n$	Equivalent input noise current		25°C	0.1			$\text{pA}/\text{Hz}$
$B_1$	Unity-gain bandwidth	See <a href="#">Figure 6-3</a>	25°C	1.7			MHz
$\Phi_m$	Phase margin at unity gain	See <a href="#">Figure 6-3</a>	25°C	47°			

## 5.10 Electrical Characteristics TLE2022xM, $V_{CC} = \pm 15\text{ V}$

at specified free-air temperature and  $V_{CC} = \pm 15\text{ V}$  (unless otherwise noted)

PARAMETER		TEST CONDITIONS	$T_A$ (1)	TLE2022M			TLE2022AM			TLE2022BM			UNIT	
				MIN	TYP	MAX	MIN	TYP	MAX	MIN	TYP	MAX		
$V_{IO}$	Input offset voltage	$V_{IC} = 0,$ $R_S = 50\ \Omega$	25°C	150 500			120 300			70 150			$\mu\text{V}$	
			Full range	700			450			300				
$\alpha_{VIO}$	Temperature coefficient of input offset voltage		Full range	2			2			2			$\mu\text{V}/^\circ\text{C}$	
	Input offset voltage long-term drift(2)		25°C	0.006			0.006			0.006			$\mu\text{V}/\text{mo}$	
$I_{IO}$	Input offset current		25°C	0.5 6			0.4 6			0.3 6			nA	
			Full range	10			10			10				
$I_{IB}$	Input bias current	25°C	35 70			33 70			30 70			nA		
		Full range	90			90			90					
$V_{ICR}$	Common-mode input voltage range	$R_S = 50\ \Omega$	25°C	-15 to 13.5 -15.3 to 14			-15 to 13.5 -15.3 to 14			-15 to 13.5 -15.3 to 14			V	
			Full range	-15 to 13.2			-15 to 13.2			-15 to 13.2				
$V_{OM+}$	Maximum positive peak output voltage swing		25°C	14 14.3			14 14.3			14 14.3			V	
			Full range	13.9			13.9			13.9				
$V_{OM-}$	Maximum negative peak output voltage swing		25°C	-13.7 -14.1			-13.7 -14.1			-13.7 -14.1			V	
			Full range	-13.6			-13.6			-13.6				
$A_{VD}$	Large-signal differential voltage amplification	$V_O = \pm 10\text{ V},$ $R_L = 10\text{ k}\Omega$	25°C	0.8 4			1 7			1.5 10			$\text{V}/\mu\text{V}$	
			Full range	0.8			1			1.5				
CMRR	Common mode rejection ratio		25°C	95 106			97 109			100 112			dB	
			Full range	91			93			96				
$k_{SVR}$	Supply-voltage rejection ratio ( $\Delta V_{CC}/\Delta V_{IO}$ )		$V_{CC} = \pm 2.5\text{ V to } \pm 15\text{ V}$	25°C	100 115			103 118			105 120			dB
				Full range	95			98			100			
$I_{CC}$	Supply current	25°C		550 700			550 700			550 700			$\mu\text{A}$	
		Full range		700			700			700				
$\Delta I_{CC}$	Supply-current change over operating temperature range	$V_O = 0,$ no load		Full range	60			60			60			$\mu\text{A}$

(1) Full range is  $-55^\circ\text{C}$  to  $+125^\circ\text{C}$ .

(2) Typical values are based on the input offset voltage shift observed through 168 hours of operating life test at  $T_A = 150^\circ\text{C}$  extrapolated to  $T_A = 25^\circ\text{C}$  using the Arrhenius equation and assuming an activation energy of 0.96 eV.

## 5.11 Operating Characteristics TLE2022M, $V_{CC} = \pm 15\text{ V}$

at specified free-air temperature and  $V_{CC} = \pm 15\text{ V}$  (unless otherwise noted)

PARAMETER		TEST CONDITIONS	$T_A$ (1)	M SUFFIX			UNIT
				MIN	TYP	MAX	
SR	Slew rate at unity gain	$V_O = 1\text{ V to } 3\text{ V},$ see <a href="#">Figure 6-1</a>	25°C	0.45	0.65		$\text{V}/\mu\text{s}$
			Full range	0.4			
$V_n$	Equivalent input noise voltage (see <a href="#">Figure 6-2</a> )	$f = 10\text{ Hz}$	25°C	19			nV/ $\sqrt{\text{Hz}}$
		$f = 1\text{ kHz}$	25°C	15			
$V_{N(PP)}$	Peak-to-peak equivalent input noise voltage	$f = 0.1\text{ Hz to } 1\text{ Hz}$	25°C	0.16			$\mu\text{V}$
		$f = 0.1\text{ Hz to } 10\text{ Hz}$	25°C	0.47			
$I_n$	Equivalent input noise current		25°C	0.1			pA/ $\sqrt{\text{Hz}}$
$B_1$	Unity-gain bandwidth	See <a href="#">Figure 6-3</a>	25°C	2.8			MHz
$\phi_m$	Phase margin at unity gain	See <a href="#">Figure 6-3</a>	25°C	52°			

(1) Full range is  $-55^\circ\text{C}$  to  $+125^\circ\text{C}$ .



## 5.12 Electrical Characteristics TLE2024xM, $V_{CC} = 5\text{ V}$

at specified free-air temperature and  $V_{CC} = 5\text{ V}$  (unless otherwise noted)

PARAMETER		TEST CONDITIONS	$T_A$ (1)	TLE2024M			TLE2024AM			TLE2024BM			UNIT	
				MIN	TYP	MAX	MIN	TYP	MAX	MIN	TYP	MAX		
$V_{IO}$	Input offset voltage	$V_{IC} = 0, R_S = 50\ \Omega$	25°C	1100			850			600			$\mu\text{V}$	
			Full range	1300			1050			800				
$\alpha_{V_{IO}}$	Temperature coefficient of input offset voltage		Full range	2			2			2			$\mu\text{V}/^\circ\text{C}$	
	Input offset voltage long-term drift(2)		25°C	0.005			0.005			0.005			$\mu\text{V}/\text{mo}$	
$I_{IO}$	Input offset current		25°C	0.6 6			0.5 6			0.4 6			nA	
			Full range	10			10			10				
$I_{IB}$	Input bias current	25°C	45 70			40 70			35 70			nA		
		Full range	90			90			90					
$V_{ICR}$	Common-mode input voltage range	$R_S = 50\ \Omega$	25°C	0 to 3.5	-0.3 to 4	0 to 3.5	-0.3 to 4	0 to 3.5	-0.3 to 4	0 to 3.5	-0.3 to 4	V		
			Full range	0 to 3.2			0 to 3.2			0 to 3.2				
$V_{OH}$	High-level output voltage		25°C	3.9 4.2			3.9 4.2			4 4.3			V	
			Full range	3.7			3.7			3.8				
$V_{OL}$	Low-level output voltage		25°C	0.7 0.8			0.7 0.8			0.7 0.8			V	
			Full range	0.95			0.95			0.95				
$A_{VD}$	Large-signal differential voltage amplification	$V_O = 1.4\text{ V to }4\text{ V}, R_L = 10\text{ k}\Omega$	25°C	0.2 1.5			0.3 1.5			0.4 1.5			$\text{V}/\mu\text{V}$	
			Full range	0.1			0.1			0.1				
CMRR	Common mode rejection ratio		25°C	80 90			82 92			85 95			dB	
			Full range	80			82			85				
$k_{SVR}$	Supply-voltage rejection ratio ( $\Delta V_{CC}/\Delta V_{IO}$ )		$V_{CC} = 5\text{ V to }30\text{ V}$	25°C	98 112			100 115			103 117			dB
				Full range	93			95			98			
$I_{CC}$	Supply current	25°C		800 1200			800 1200			800 1200			$\mu\text{A}$	
		Full range		1200			1200			1200				
$\Delta I_{CC}$	Supply-current change over operating temperature range	Full range		50			50			50			$\mu\text{A}$	

(1) Full range is  $-55^\circ\text{C}$  to  $+125^\circ\text{C}$ .

(2) Typical values are based on the input offset voltage shift observed through 168 hours of operating life test at  $T_A = 150^\circ\text{C}$  extrapolated to  $T_A = 25^\circ\text{C}$  using the Arrhenius equation and assuming an activation energy of 0.96 eV.

## 5.13 Operating Characteristics TLE2024M, $V_{CC} = 5\text{ V}$

at  $T_A = 25^\circ\text{C}$  and  $V_{CC} = 5\text{ V}$  (unless otherwise noted)

PARAMETER		TEST CONDITIONS	$T_A$	M SUFFIX			UNIT
				MIN	TYP	MAX	
SR	Slew rate at unity gain	$V_O = 1\text{ V to }3\text{ V}$ , see <a href="#">Figure 6-1</a>	25°C	0.5			$\text{V}/\mu\text{s}$
$V_n$	Equivalent input noise voltage (see <a href="#">Figure 6-2</a> )	$f = 10\text{ Hz}$	25°C	21			$\text{nV}/\text{Hz}$
		$f = 1\text{ kHz}$	25°C	17			
$V_{N(PP)}$	Peak-to-peak equivalent input noise voltage	$f = 0.1\text{ Hz to }1\text{ Hz}$	25°C	0.16			$\mu\text{V}$
		$f = 0.1\text{ Hz to }10\text{ Hz}$	25°C	0.47			
$I_n$	Equivalent input noise current		25°C	0.1			$\text{pA}/\text{Hz}$
$B_1$	Unity-gain bandwidth	See <a href="#">Figure 6-3</a>	25°C	1.7			MHz
$\Phi_m$	Phase margin at unity gain	See <a href="#">Figure 6-3</a>	25°C	47°			

## 5.14 Electrical Characteristics TLE2024xM, $V_{CC} = \pm 15\text{ V}$

at specified free-air temperature and  $V_{CC} = \pm 15\text{ V}$  (unless otherwise noted)

PARAMETER		TEST CONDITIONS	$T_A$ (1)	TLE2024M			TLE2024AM			TLE2024BM			UNIT
				MIN	TYP	MAX	MIN	TYP	MAX	MIN	TYP	MAX	
$V_{IO}$	Input offset voltage	$V_{IC} = 0,$ $R_S = 50\ \Omega$	25°C	1000			750			500			$\mu\text{V}$
			Full range	1200			950			700			
$\alpha_{VIO}$	Temperature coefficient of input offset voltage		Full range	2			2			2			$\mu\text{V}/^\circ\text{C}$
	Input offset voltage long-term drift(2)		25°C	0.006			0.006			0.006			$\mu\text{V}/\text{mo}$
$I_{IO}$	Input offset current		25°C	0.6 6			0.5 6			0.4 6			nA
			Full range	10			10			10			
$I_{IB}$	Input bias current	25°C	50 70			45 70			40 70			nA	
		Full range	90			90			90				
$V_{ICR}$	Common-mode input voltage range	$R_S = 50\ \Omega$	25°C	-15 to 13.5	-15.3 to 14	-15 to 13.5	-15.3 to 14	-15 to 13.5	-15.3 to 14	-15 to 13.5	-15.3 to 14	V	
			Full range	-15 to 13.2		-15 to 13.2		-15 to 13.2		-15 to 13.2			
$V_{OM+}$	Maximum positive peak output voltage swing		25°C	13.8	14.1	13.9	14.2	14	14.3	V			
			Full range	13.7		13.7		13.8					
$V_{OM-}$	Maximum negative peak output voltage swing		25°C	-13.7	-14.1	-13.7	-14.1	-13.7	-14.1	V			
			Full range	-13.6		-13.6		-13.6					
$A_{VD}$	Large-signal differential voltage amplification	$V_O = \pm 10\text{ V},$ $R_L = 10\text{ k}\Omega$	25°C	0.4	2	0.8	4	1	7	$\text{V}/\mu\text{V}$			
			Full range	0.4		0.8		1					
CMRR	Common mode rejection ratio		25°C	92	102	94	105	97	108	dB			
			Full range	88		90		93					
$k_{SVR}$	Supply-voltage rejection ratio ( $\Delta V_{CC}/\Delta V_{IO}$ )		$V_{CC} = \pm 2.5\text{ V to } \pm 15\text{ V}$	25°C	98	112	100	115	103	117	dB		
				Full range	93		95		98				
$I_{CC}$	Supply current	25°C		1050 1400		1050 1400		1050 1400		$\mu\text{A}$			
		Full range		1400			1400						
$\Delta I_{CC}$	Supply-current change over operating temperature range	$V_O = 0,$ no load		Full range	85		85		85		$\mu\text{A}$		

(1) Full range is  $-55^\circ\text{C}$  to  $+125^\circ\text{C}$ .

(2) Typical values are based on the input offset voltage shift observed through 168 hours of operating life test at  $T_A = 150^\circ\text{C}$  extrapolated to  $T_A = 25^\circ\text{C}$  using the Arrhenius equation and assuming an activation energy of 0.96 eV.

## 5.15 Operating Characteristics TLE2024M, $V_{CC} = \pm 15\text{ V}$

at specified free-air temperature and  $V_{CC} = \pm 15\text{ V}$  (unless otherwise noted)

PARAMETER		TEST CONDITIONS	$T_A$ (1)	M SUFFIX			UNIT
				MIN	TYP	MAX	
SR	Slew rate at unity gain	$V_O = 1\text{ V to } 3\text{ V},$ see <a href="#">Figure 6-1</a>	25°C	0.45	0.7	$\text{V}/\mu\text{s}$	
			Full range	0.42			
$V_n$	Equivalent input noise voltage (see <a href="#">Figure 6-2</a> )	$f = 10\text{ Hz}$	25°C	19		nV/ $\sqrt{\text{Hz}}$	
		$f = 1\text{ kHz}$	25°C	15			
$V_{N(PP)}$	Peak-to-peak equivalent input noise voltage	$f = 0.1\text{ Hz to } 1\text{ Hz}$	25°C	0.16		$\mu\text{V}$	
		$f = 0.1\text{ Hz to } 10\text{ Hz}$	25°C	0.47			
$I_n$	Equivalent input noise current		25°C	0.1		pA/ $\sqrt{\text{Hz}}$	
$B_1$	Unity-gain bandwidth	See <a href="#">Figure 6-3</a>	25°C	2.8		MHz	
$\phi_m$	Phase margin at unity gain	See <a href="#">Figure 6-3</a>	25°C	52°			

(1) Full range is  $-55^\circ\text{C}$  to  $+125^\circ\text{C}$ .

## 5.16 Typical Characteristics

**Table 5-1. Table of Graphs**

			FIGURE
$V_{IO}$	Input offset voltage	Distribution	4-1 to 4-3
$I_{IB}$	Input bias current	vs Common-mode input voltage vs Free-air temperature	4-4 to 4-9
$I_I$	Input current	vs Differential input voltage	4-10
$V_{OM}$	Maximum peak output voltage	vs Output current vs Free-air temperature	4-11 to 4-14
$V_{OH}$	High-level output voltage	vs High-level output current vs Free-air temperature	4-15 to 4-17
$V_{OL}$	Low-level output voltage	vs Low-level output current vs Free-air temperature	4-18, 4-19
$V_{O(PP)}$	Maximum peak-to-peak output voltage	vs Frequency	4-20, 4-21
$A_{VD}$	Large-signal differential voltage amplification and phase shift	vs Frequency	4-22
	Large-signal differential voltage amplification	vs Free-air temperature	4-23 to 4-25
$I_{OS}$	Short-circuit output current	vs Supply voltage vs Free-air temperature	4-26 to 4-33
$I_{CC}$	Supply current	vs Supply voltage vs Free-air temperature	4-34 to 4-39
CMRR	Common-mode rejection ratio	vs Frequency	4-40 to 4-42
SR	Slew rate	vs Free-air temperature	4-43 to 4-45
	Voltage-follower small-signal pulse response		4-46, 4-47
	Voltage-follower large-signal pulse response		4-48 to 4-53
$V_{N(PP)}$	Peak-to-peak equivalent input noise voltage	0.1Hz to 1Hz 0.1Hz to 10Hz	4-54, 4-55
$V_n$	Equivalent input noise voltage	vs Frequency	4-56
$B_1$	Unity-gain bandwidth	vs Supply voltage	4-57 to 4-60
		vs Free-air temperature	
$\phi_m$	Phase margin	vs Supply voltage	4-61 to 4-66
		vs Load capacitance	
		vs Free-air temperature	
	Phase shift	vs Frequency	4-22

### 5.16 Typical Characteristics (continued)

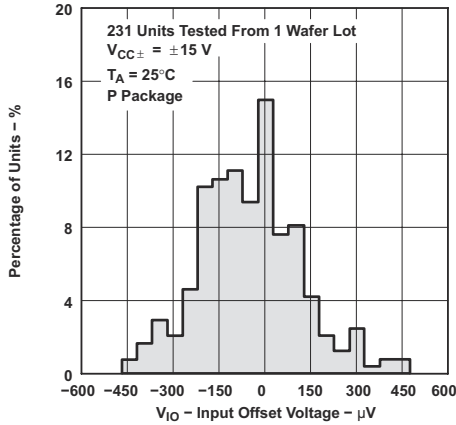


Figure 5-1. Distribution of TLE2021xM Input Offset Voltage

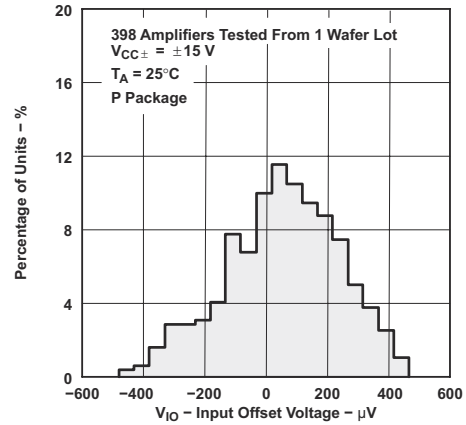


Figure 5-2. Distribution of TLE2022xM Input Offset Voltage

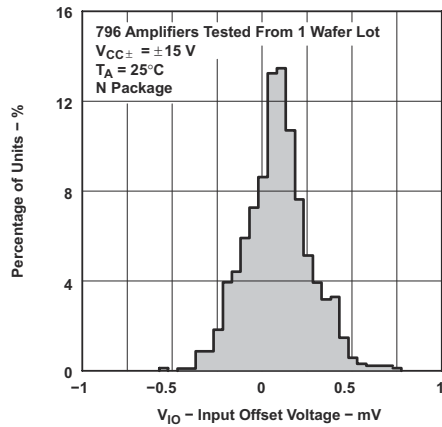


Figure 5-3. Distribution of TLE2024xM Input Offset Voltage

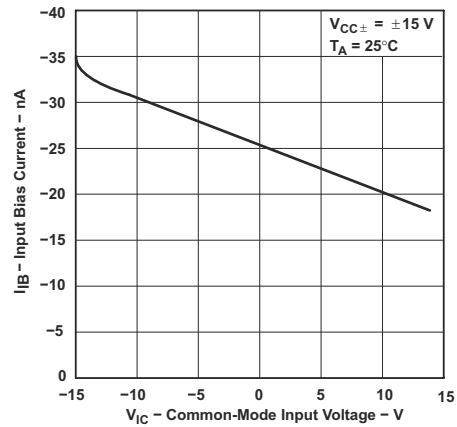


Figure 5-4. TLE2021xM Input Bias Current vs Common-Mode Input Voltage

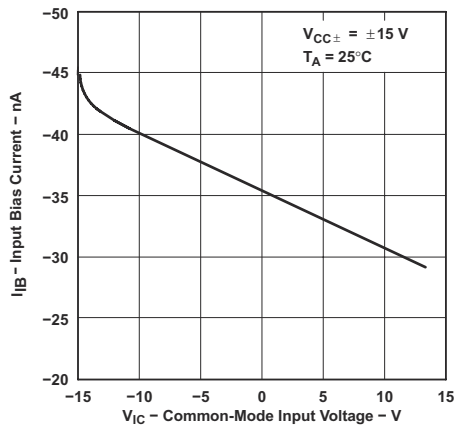


Figure 5-5. TLE2022xM Input Bias Current vs Common-Mode Input Voltage

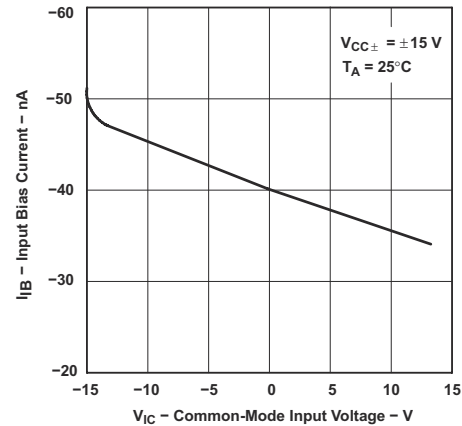
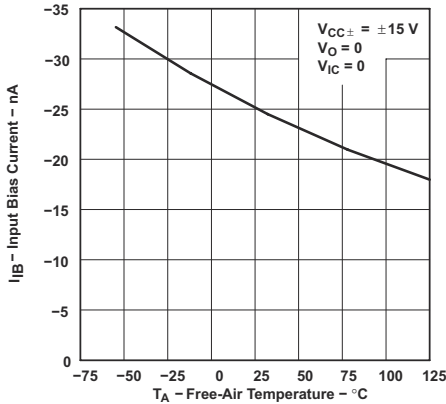


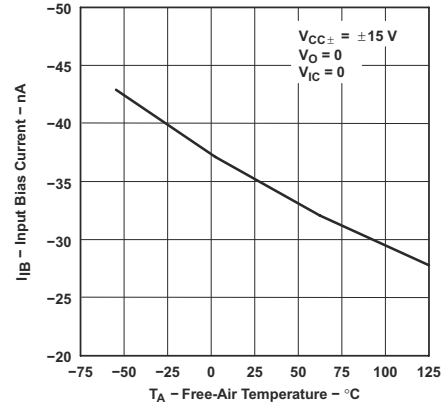
Figure 5-6. TLE2024xM Input Bias Current vs Common-Mode Input Voltage

**5.16 Typical Characteristics (continued)**



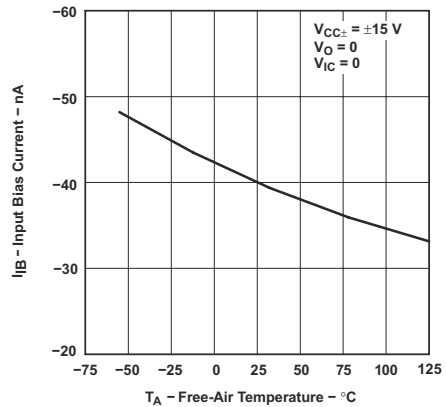
Data at high and low temperatures applicable only within rated operating free-air temperature ranges of the various devices

**Figure 5-7. TLE2021xM Input Bias Current vs Free-Air Temperature**



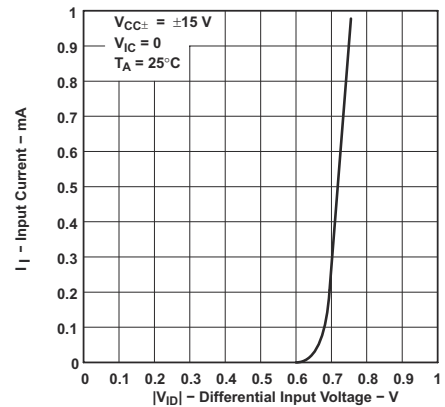
Data at high and low temperatures applicable only within rated operating free-air temperature ranges of the various devices

**Figure 5-8. TLE2022xM Input Bias Current vs Free-Air Temperature**

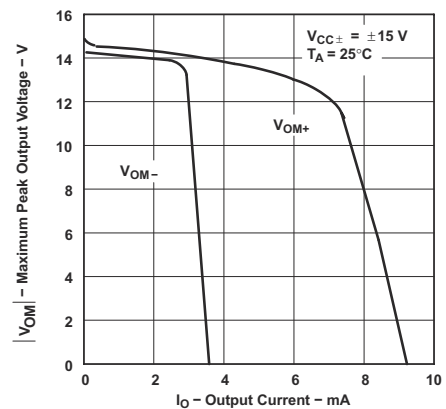


Data at high and low temperatures applicable only within rated operating free-air temperature ranges of the various devices

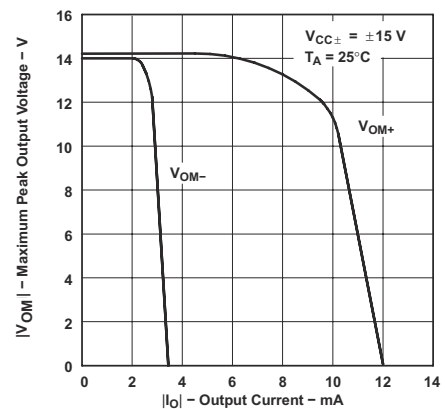
**Figure 5-9. TLE2024xM Input Bias Current vs Free-Air Temperature**



**Figure 5-10. Input Current vs Differential Input Voltage**

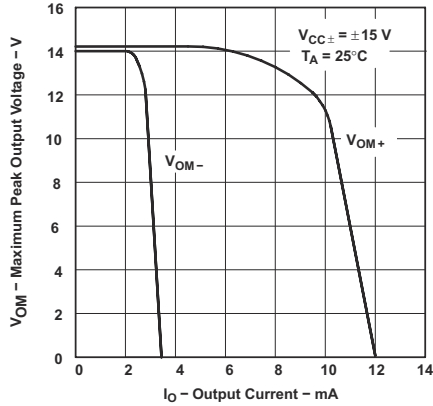


**Figure 5-11. TLE2021xM Maximum Peak Output Voltage vs Output Current**

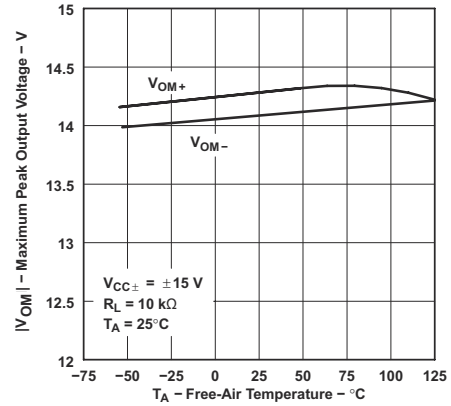


**Figure 5-12. TLE2022xM Maximum Peak Output Voltage vs Output Current**

### 5.16 Typical Characteristics (continued)

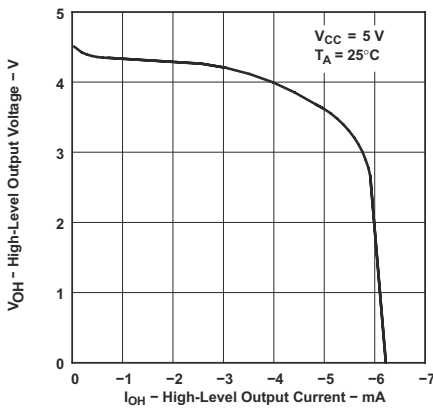


**Figure 5-13. TLE2024xM Maximum Peak Output Voltage vs Output Current**

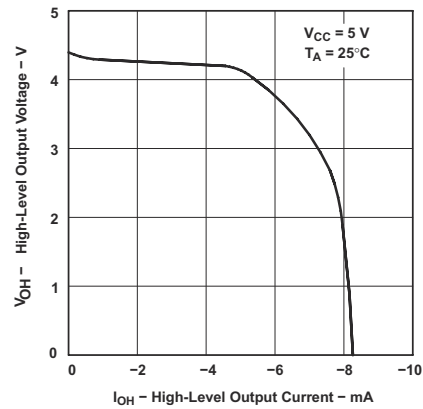


Data at high and low temperatures applicable only within rated operating free-air temperature ranges of the various devices

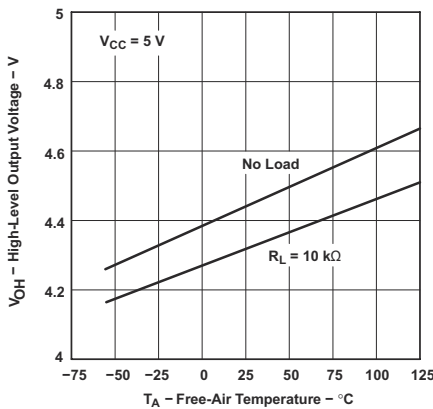
**Figure 5-14. Maximum Peak Output Voltage vs Free-Air Temperature**



**Figure 5-15. TLE2021xM High-Level Output Voltage vs High-Level Output Current**

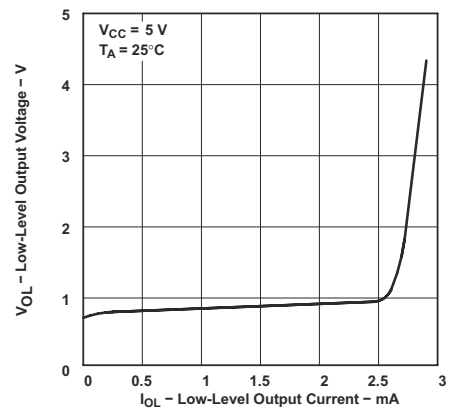


**Figure 5-16. TLE2022xM and TLE2024xM High-Level Output Voltage vs High-Level Output Current**



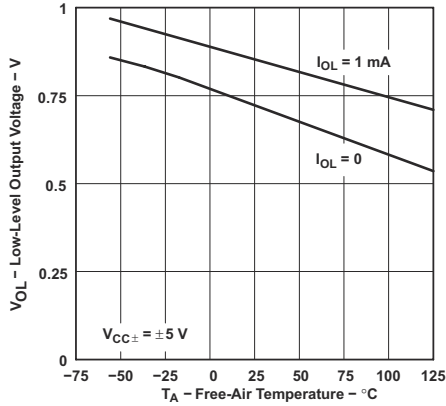
Data at high and low temperatures applicable only within rated operating free-air temperature ranges of the various devices

**Figure 5-17. High-Level Output Voltage vs Free-Air Temperature**



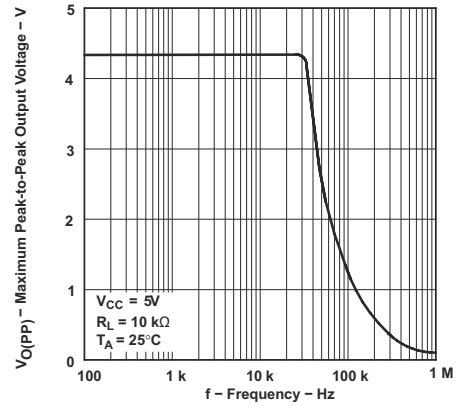
**Figure 5-18. Low-Level Output Voltage vs Low-Level Output Current**

**5.16 Typical Characteristics (continued)**

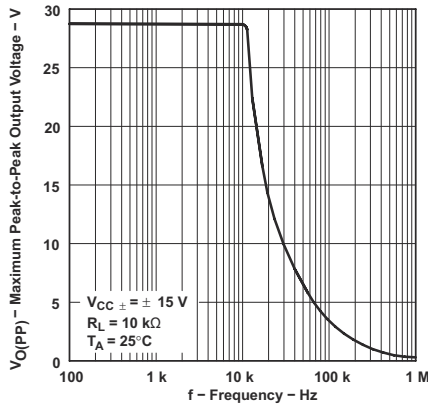


Data at high and low temperatures applicable only within rated operating free-air temperature ranges of the various devices

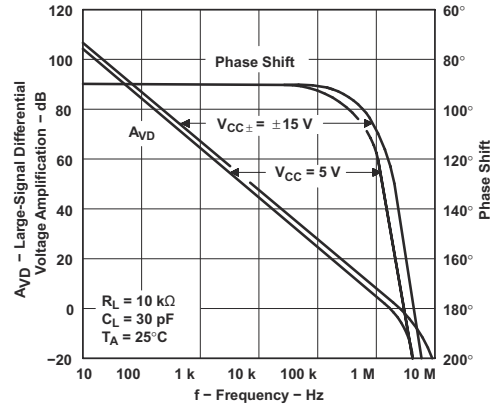
**Figure 5-19. Low-Level Output Voltage vs Free-Air Temperature**



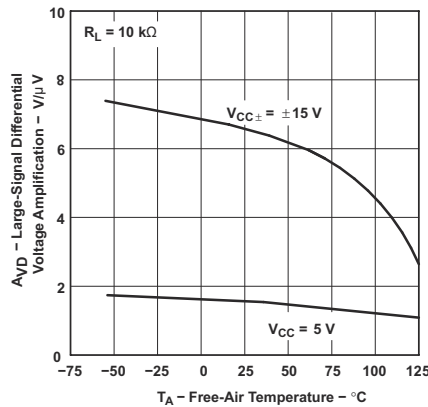
**Figure 5-20. Maximum Peak-to-Peak Output Voltage Vs Frequency**



**Figure 5-21. Maximum Peak-to-Peak Output Voltage vs Frequency**

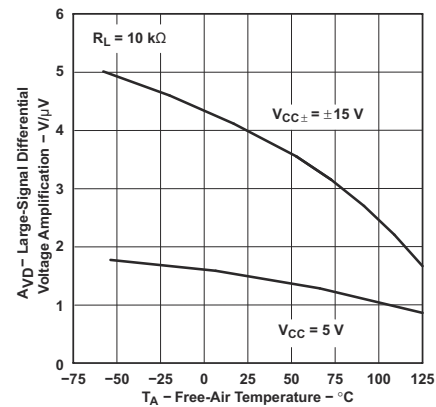


**Figure 5-22. Large-Signal Differential Voltage Amplification and Phase Shift vs Frequency**



Data at high and low temperatures applicable only within rated operating free-air temperature ranges of the various devices

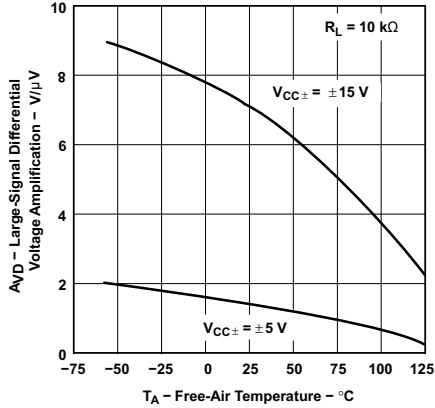
**Figure 5-23. TLE2021xM Large-Scale Differential Voltage Amplification vs Free-Air Temperature**



Data at high and low temperatures applicable only within rated operating free-air temperature ranges of the various devices

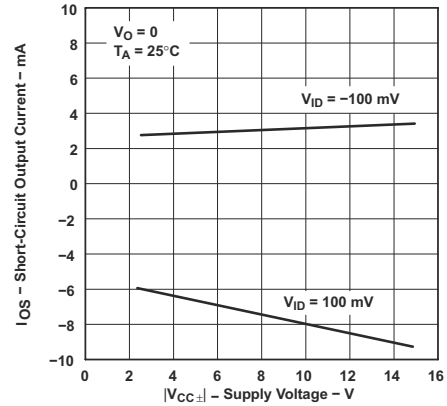
**Figure 5-24. TLE2022xM Large-Signal Differential Voltage Amplification vs Free-Air Temperature**

### 5.16 Typical Characteristics (continued)

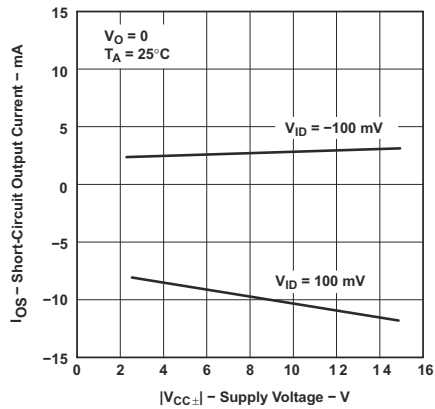


Data at high and low temperatures applicable only within rated operating free-air temperature ranges of the various devices

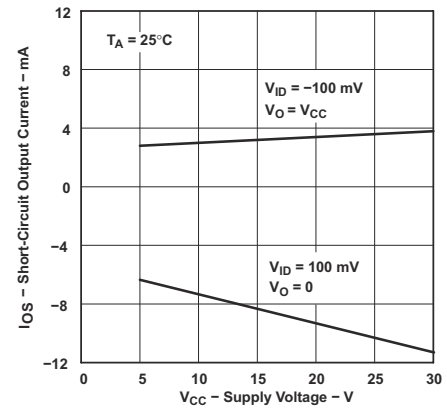
**Figure 5-25. TLE2024xM Large-Scale Differential Voltage Amplification vs Free-Air Temperature**



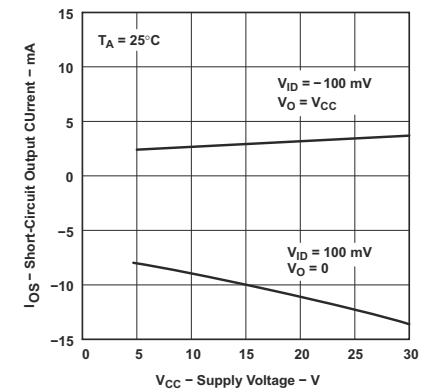
**Figure 5-26. TLE2021xM Short-Circuit Output Current vs Supply Voltage**



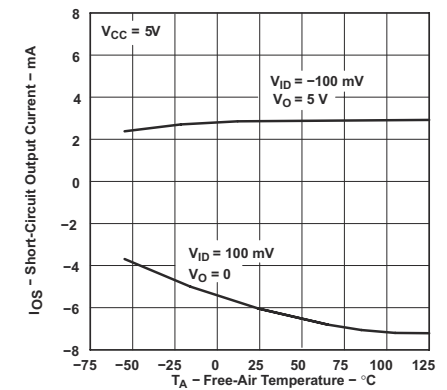
**Figure 5-27. TLE2022xM and TLE2024xM Short-Circuit Output Current vs Supply Voltage**



**Figure 5-28. TLE2021xM Short-Circuit Output Current vs Supply Voltage**



**Figure 5-29. TLE2022xM and TLE2024xM Short-Circuit Output Current vs Supply Voltage**

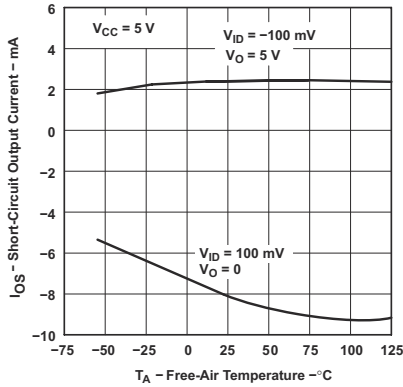


Data at high and low temperatures applicable only within rated operating free-air temperature ranges of the various devices

**Figure 5-30. TLE2021xM Short-Circuit Output Current vs Free-Air Temperature**

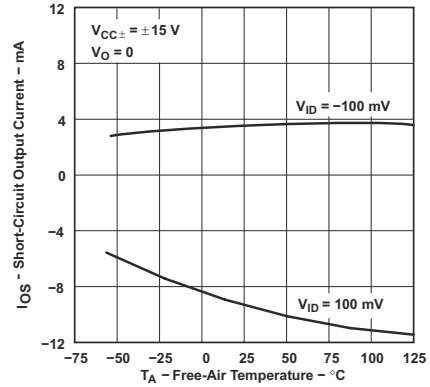


**5.16 Typical Characteristics (continued)**



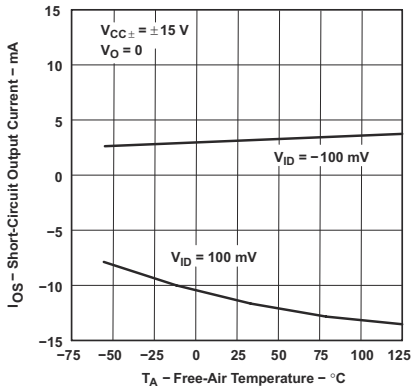
Data at high and low temperatures applicable only within rated operating free-air temperature ranges of the various devices

**Figure 5-31. TLE2022xM and TLE2024xM Short-Circuit Output Current vs Free-Air Temperature**



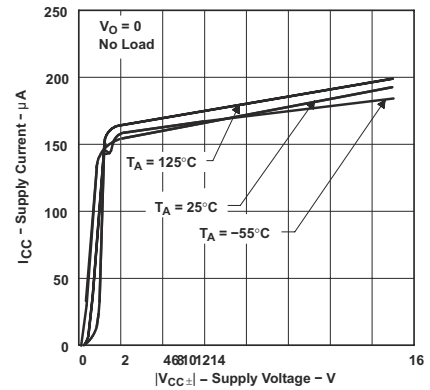
Data at high and low temperatures applicable only within rated operating free-air temperature ranges of the various devices

**Figure 5-32. TLE2021xM Short-Circuit Output Current vs Free-Air Temperature**

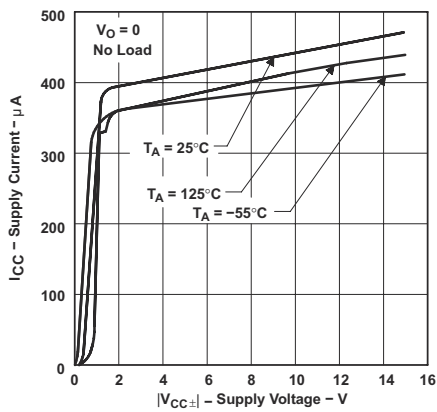


Data at high and low temperatures applicable only within rated operating free-air temperature ranges of the various devices

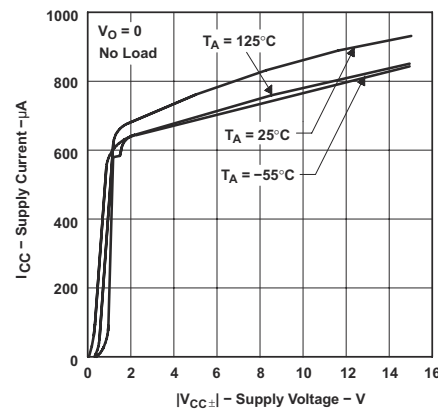
**Figure 5-33. TLE2022xM and TLE2024xM Short-Circuit Output Current vs Free-Air Temperature**



**Figure 5-34. TLE2021xM Supply Current vs Supply Voltage**

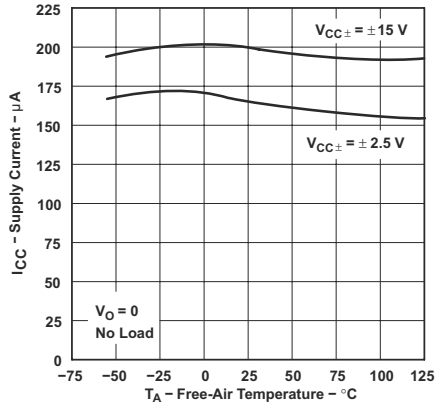


**Figure 5-35. TLE2022xM Supply Current vs Supply Voltage**



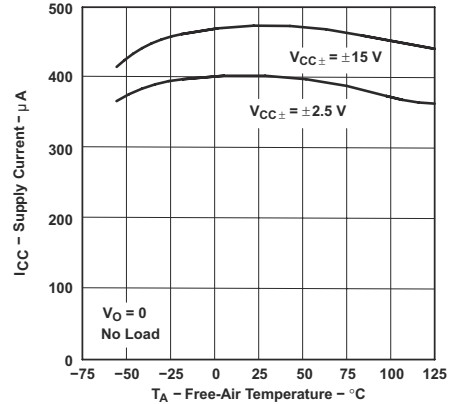
**Figure 5-36. TLE2024xM Supply Current vs Supply Voltage**

### 5.16 Typical Characteristics (continued)



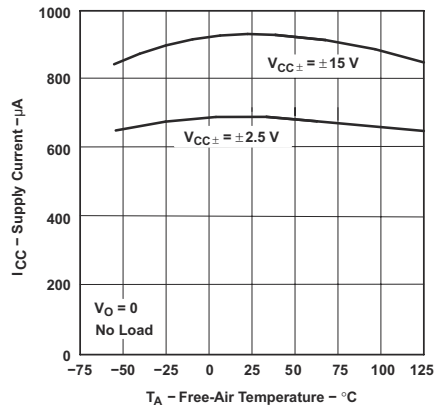
Data at high and low temperatures applicable only within rated operating free-air temperature ranges of the various devices

**Figure 5-37. TLE2021xM Supply Current vs Free-Air Temperature**



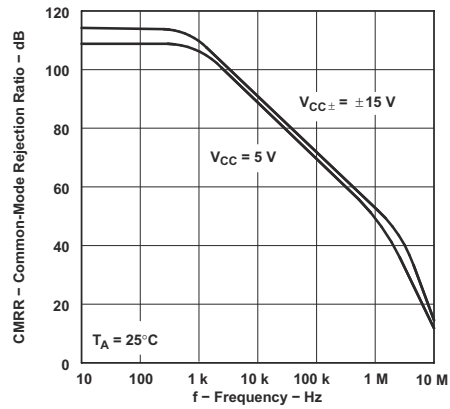
Data at high and low temperatures applicable only within rated operating free-air temperature ranges of the various devices

**Figure 5-38. TLE2022xM Supply Current vs Free-Air Temperature**

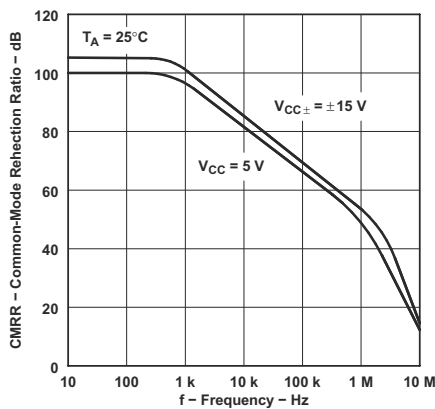


Data at high and low temperatures applicable only within rated operating free-air temperature ranges of the various devices

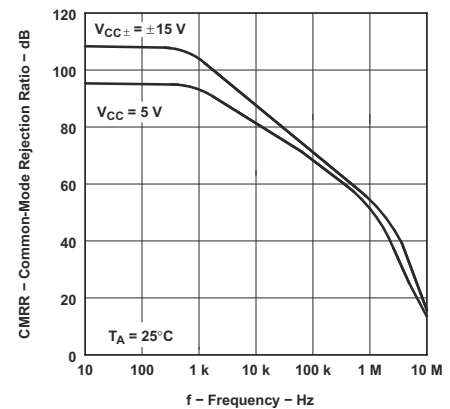
**Figure 5-39. TLE2024xM Supply Current vs Free-Air Temperature**



**Figure 5-40. TLE2021xM Common-Mode Rejection Ratio vs Frequency**

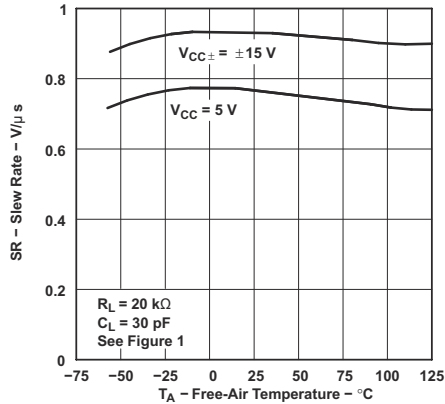


**Figure 5-41. TLE2022xM Common-Mode Rejection Ratio vs Frequency**



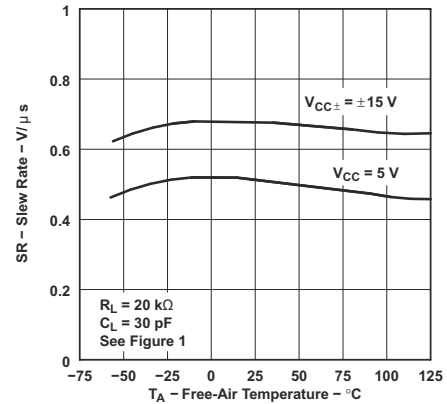
**Figure 5-42. TLE2024xM Common-Mode Rejection Ratio vs Frequency**

### 5.16 Typical Characteristics (continued)



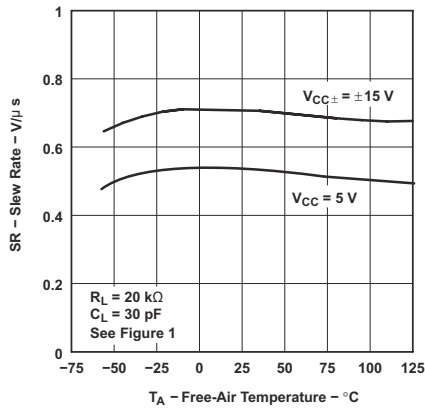
Data at high and low temperatures applicable only within rated operating free-air temperature ranges of the various devices

**Figure 5-43. TLE2021xM Slew Rate vs Free-Air Temperature**



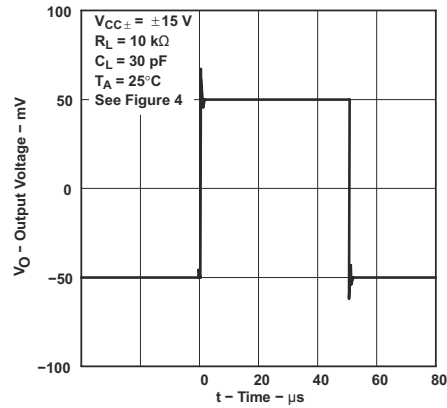
Data at high and low temperatures applicable only within rated operating free-air temperature ranges of the various devices

**Figure 5-44. TLE2022xM Slew Rate vs Free-Air Temperature**

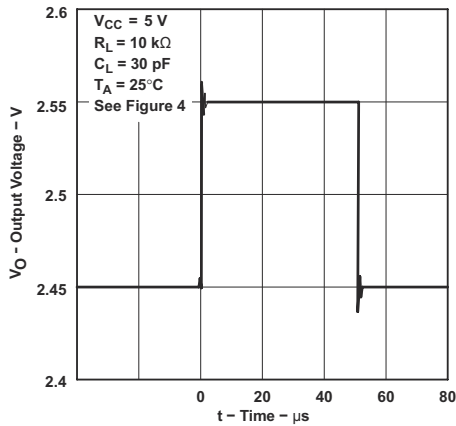


Data at high and low temperatures applicable only within rated operating free-air temperature ranges of the various devices

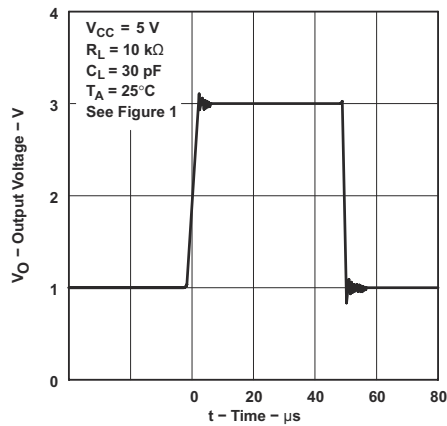
**Figure 5-45. TLE2024xM Slew Rate vs Free-Air Temperature**



**Figure 5-46. Voltage-Follower Small-Signal Pulse Response**



**Figure 5-47. Voltage-Follower Small-Signal Pulse Response**



**Figure 5-48. TLE2021xM Voltage-Follower Large-Signal Pulse Response**

### 5.16 Typical Characteristics (continued)

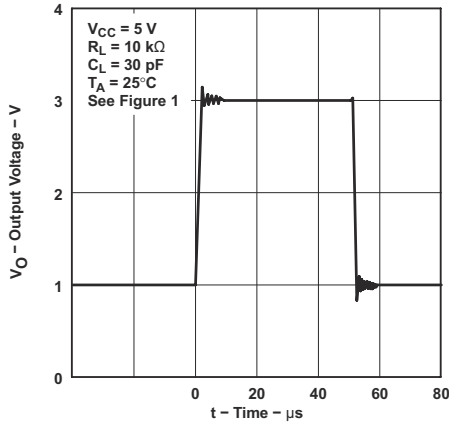


Figure 5-49. TLE2022xM Voltage-Follower Large-Signal Pulse Response

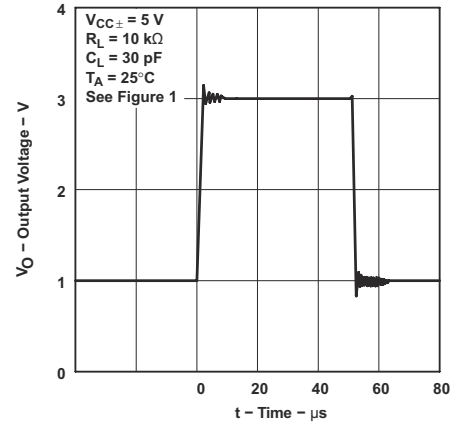


Figure 5-50. TLE2024xM Voltage-Follower Large-Scale Pulse Response

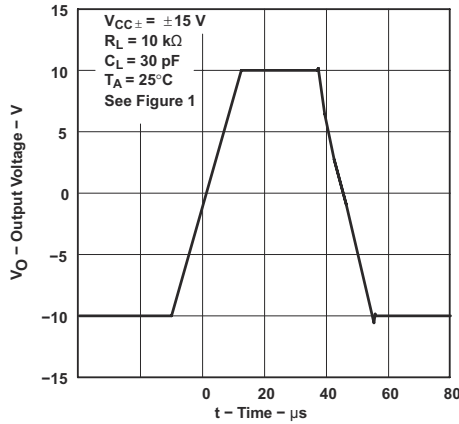


Figure 5-51. TLE2021xM Voltage-Follower Large-Signal Pulse Response

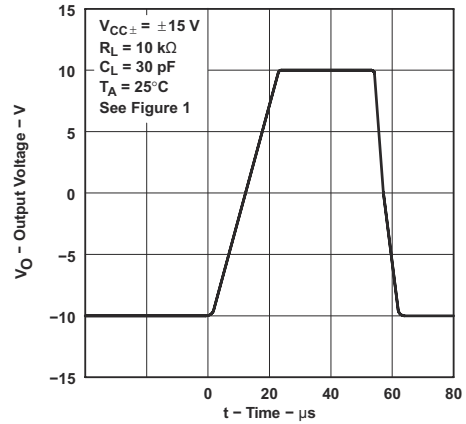


Figure 5-52. TLE2022xM Voltage-Follower Large-Signal Pulse Response

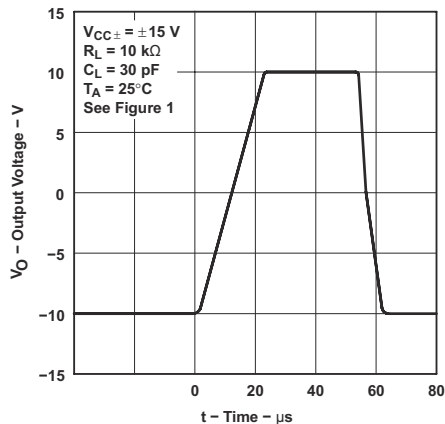


Figure 5-53. TLE2024xM Voltage-Follower Large-Signal Pulse Response

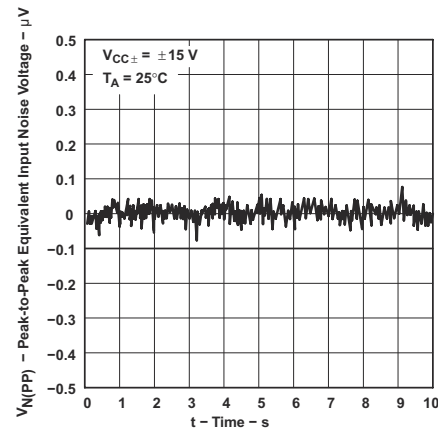
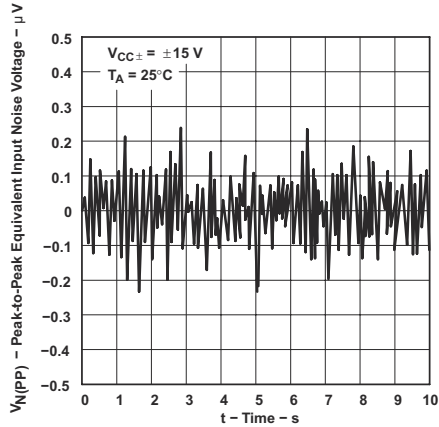
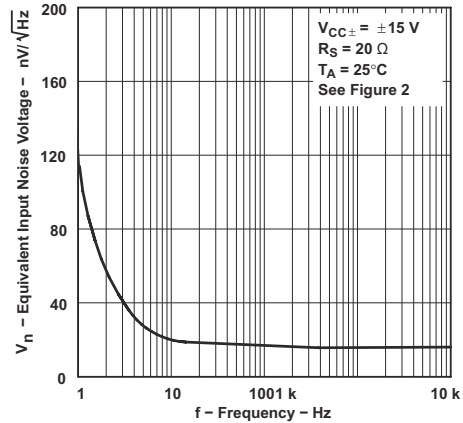


Figure 5-54. Peak-to-Peak Equivalent Input Noise Voltage 0.1Hz to 1Hz

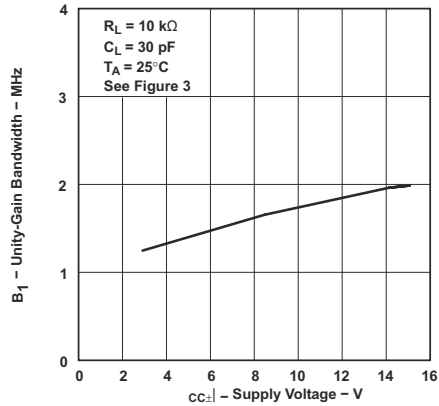
**5.16 Typical Characteristics (continued)**



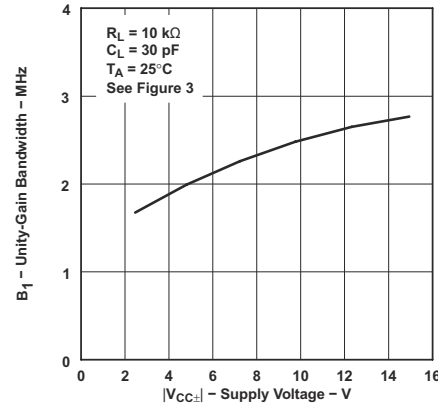
**Figure 5-55. Peak-to-Peak Equivalent Input Noise Voltage 0.1Hz to 10Hz**



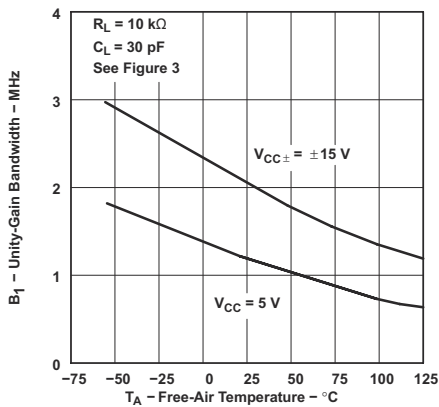
**Figure 5-56. Equivalent Input Noise Voltage vs Frequency**



**Figure 5-57. TLE2021xM Unity-Gain Bandwidth vs Supply Voltage**

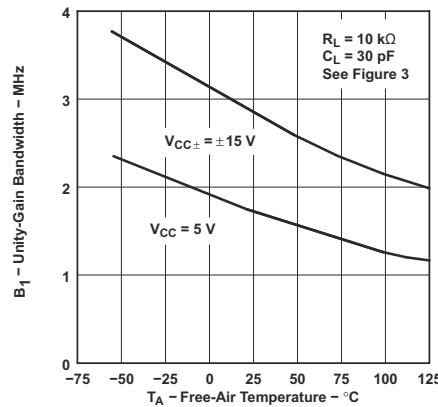


**Figure 5-58. TLE2022xM and TLE2024xM Unity-Gain Bandwidth vs Supply Voltage**



Data at high and low temperatures applicable only within rated operating free-air temperature ranges of the various devices

**Figure 5-59. TLE2021xM Unity-Gain Bandwidth vs Free-Air Temperature**



Data at high and low temperatures applicable only within rated operating free-air temperature ranges of the various devices

**Figure 5-60. TLE2022xM and TLE2024xM Unity-Gain Bandwidth vs Free-Air Temperature**

### 5.16 Typical Characteristics (continued)

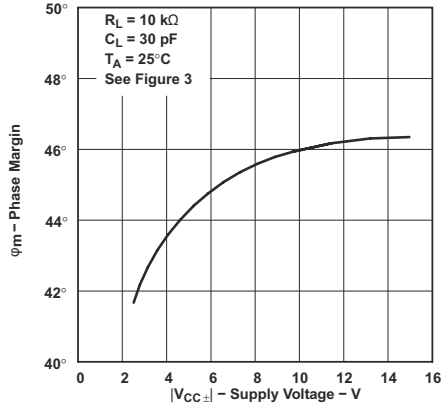


Figure 5-61. TLE2021xM Phase Margin vs Supply Voltage

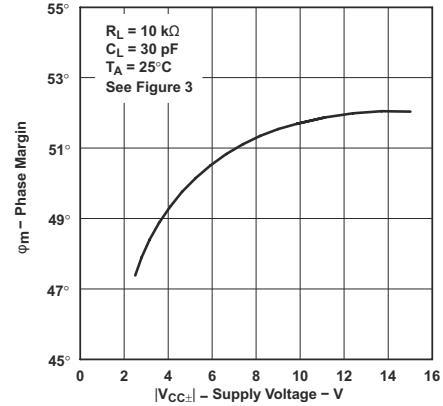


Figure 5-62. TLE2022xM and TLE2024xM Phase Margin vs Supply Voltage

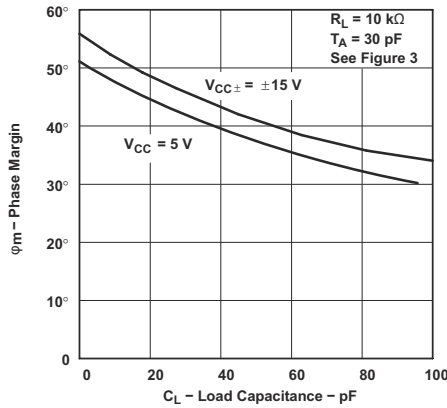


Figure 5-63. TLE2021xM Phase Margin vs Load Capacitance

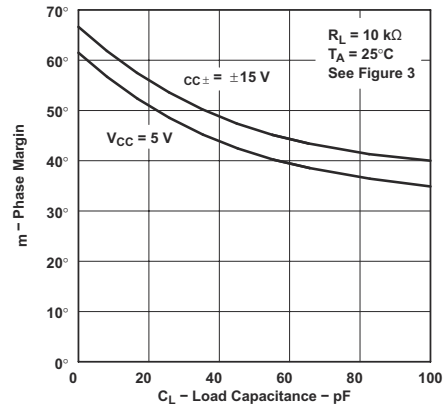
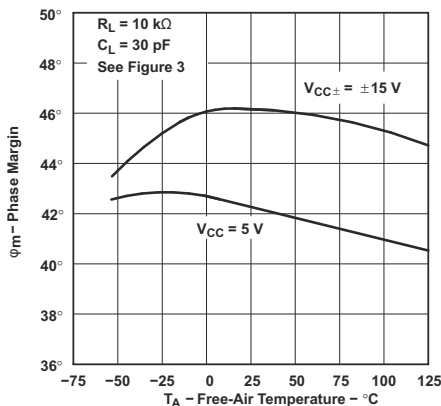
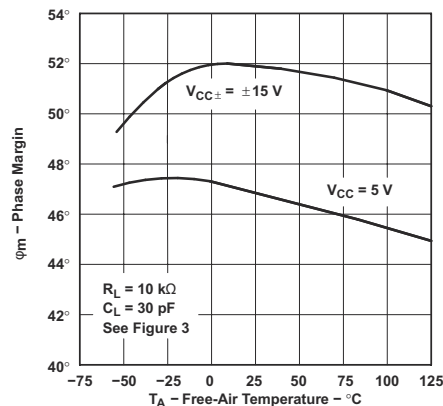


Figure 5-64. TLE2022xM and TLE2024xM Phase Margin vs Load Capacitance



Data at high and low temperatures applicable only within rated operating free-air temperature ranges of the various devices

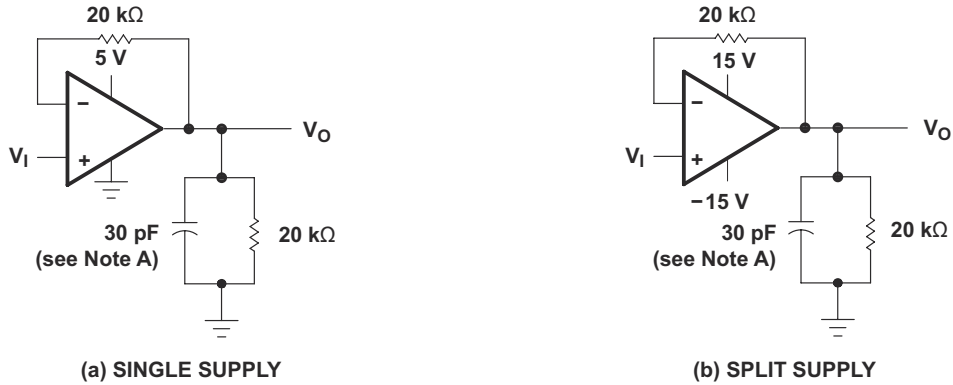
Figure 5-65. TLE2021xM Phase Margin vs Free-Air Temperature



Data at high and low temperatures applicable only within rated operating free-air temperature ranges of the various devices

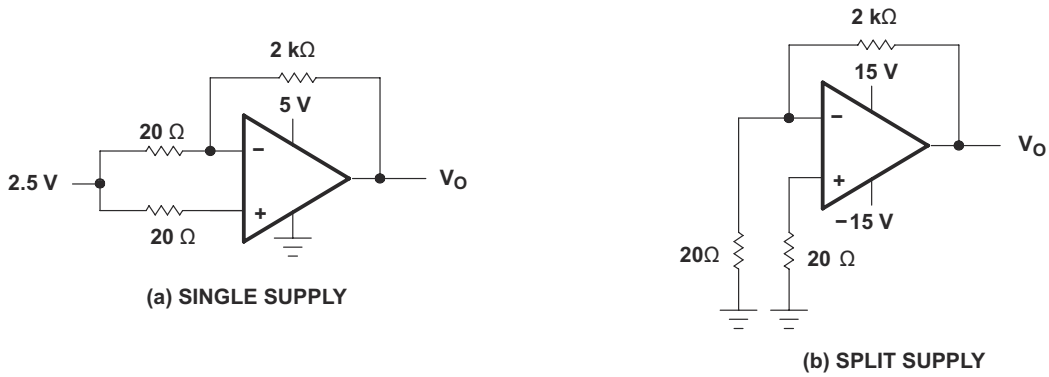
Figure 5-66. TLE2022xM and TLE2024xM Phase Margin vs Free-Air Temperature

## 6 Parameter Measurement Information

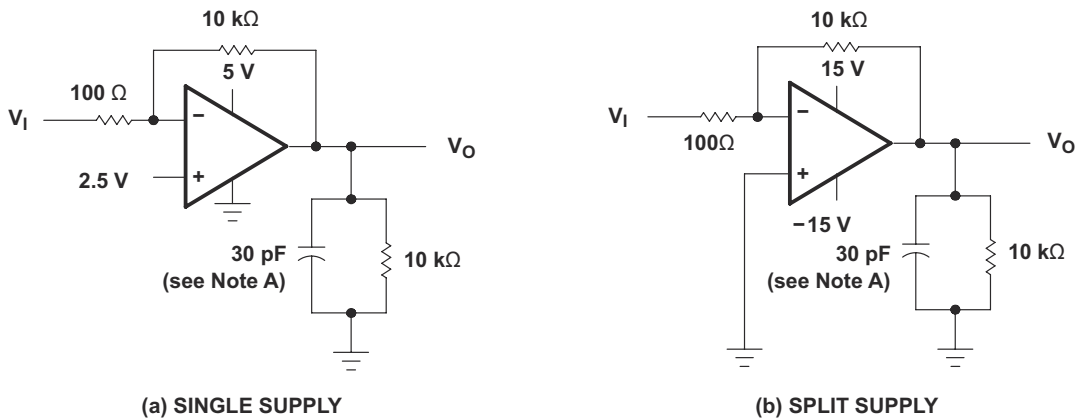


A.  $C_L$  includes fixture capacitance.

**Figure 6-1. Slew-Rate Test Circuit**

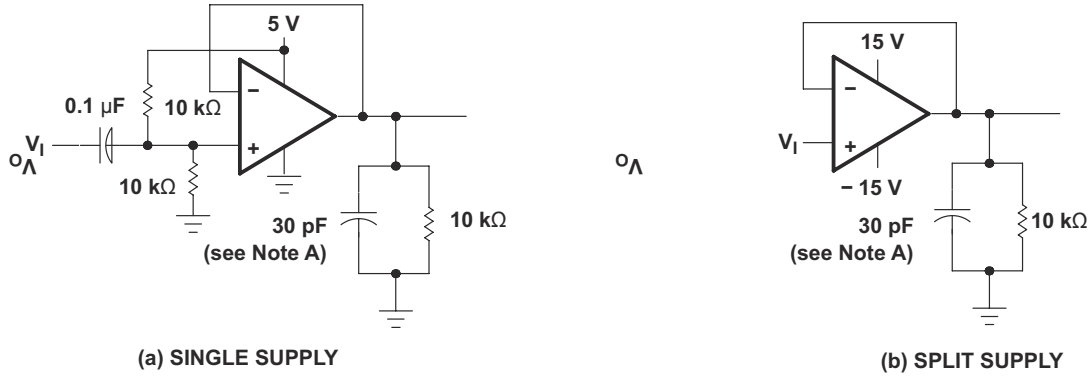


**Figure 6-2. Noise-Voltage Test Circuit**



A.  $C_L$  includes fixture capacitance.

**Figure 6-3. Unity-Gain Bandwidth and Phase-Margin Test Circuit**



A.  $C_L$  includes fixture capacitance.

**Figure 6-4. Small-Signal Pulse-Response Test Circuit**

### 6.1 Typical Values

Typical values presented in this data sheet represent the median (50% point) of device parametric performance.



## 7 Detailed Description

### 7.1 Functional Block Diagram

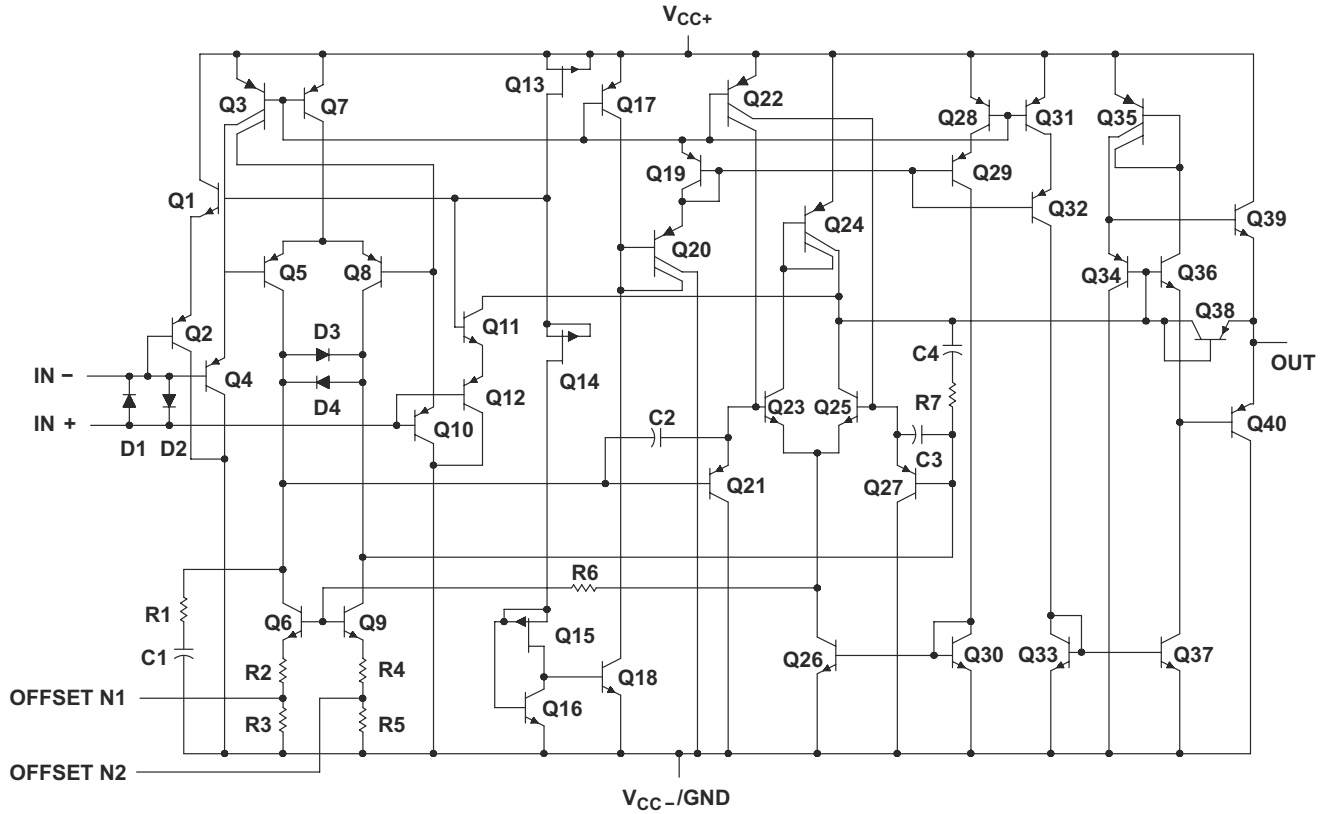


Figure 7-1. Equivalent Schematic (Each Amplifier)

Table 7-1. Actual Device Component Count

COMPONENT	TLE2021	TLE2022	TLE2024
Transistors	40	80	160
Resistors	7	14	28
Diodes	4	8	16
Capacitors	4	8	16

## 8 Application and Implementation

### Note

Information in the following applications sections is not part of the TI component specification, and TI does not warrant its accuracy or completeness. TI's customers are responsible for determining suitability of components for their purposes, as well as validating and testing their design implementation to confirm system functionality.

### 8.1 Application Information

#### 8.1.1 Voltage-Follower Applications

The TLE202xM circuitry includes input-protection diodes to limit the voltage across the input transistors; however, no provision is made in the circuit to limit the current if these diodes are forward biased. This condition sometimes occurs when the device is operated in the voltage-follower configuration and driven with a fast, large-signal pulse. Use a feedback resistor to limit the current to a maximum of 1mA to prevent degradation of the device. This feedback resistor forms a pole with the input capacitance of the device. For feedback resistor values greater than 10kΩ, this pole degrades the amplifier phase margin. Figure 8-1 shows that to alleviate this problem, add a capacitor (20pF to 50pF) in parallel with the feedback resistor.

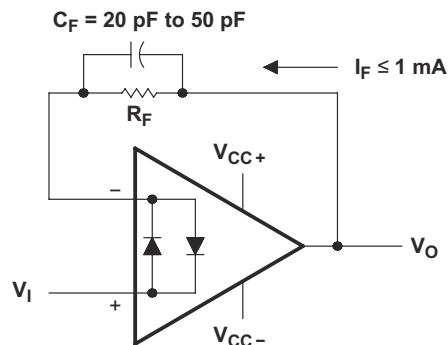


Figure 8-1. Voltage Follower

#### 8.1.2 Input Offset Voltage Null

The TLE202xM series offers external null pins that further reduce the input offset voltage. Figure 8-2 shows how to connect the circuit if this feature is desired. When external null is not needed, leave the null pins disconnected.

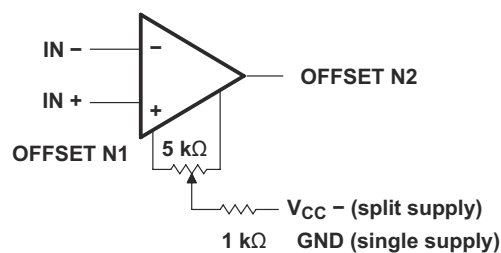


Figure 8-2. Input Offset Voltage Null Circuit

### 8.1.3 Macromodel Information

Macromodel information derived using Microsim Parts™, the model generation software used with PSpice™. The Boyle macromodel<sup>1</sup> (see subcircuit in Figure 8-3, Figure 8-4, and Figure 8-5) are generated using the TLE202x typical electrical and operating characteristics at 25°C. Using this information, output simulations of the following key parameters are generated to a tolerance of 20% (in most cases):

- Maximum positive output voltage swing
- Maximum negative output voltage swing
- Slew rate
- Quiescent power dissipation
- Input bias current
- Open-loop voltage amplification
- Unity-gain frequency
- Common-mode rejection ratio
- Phase margin
- DC output resistance
- AC output resistance
- Short-circuit output current limit

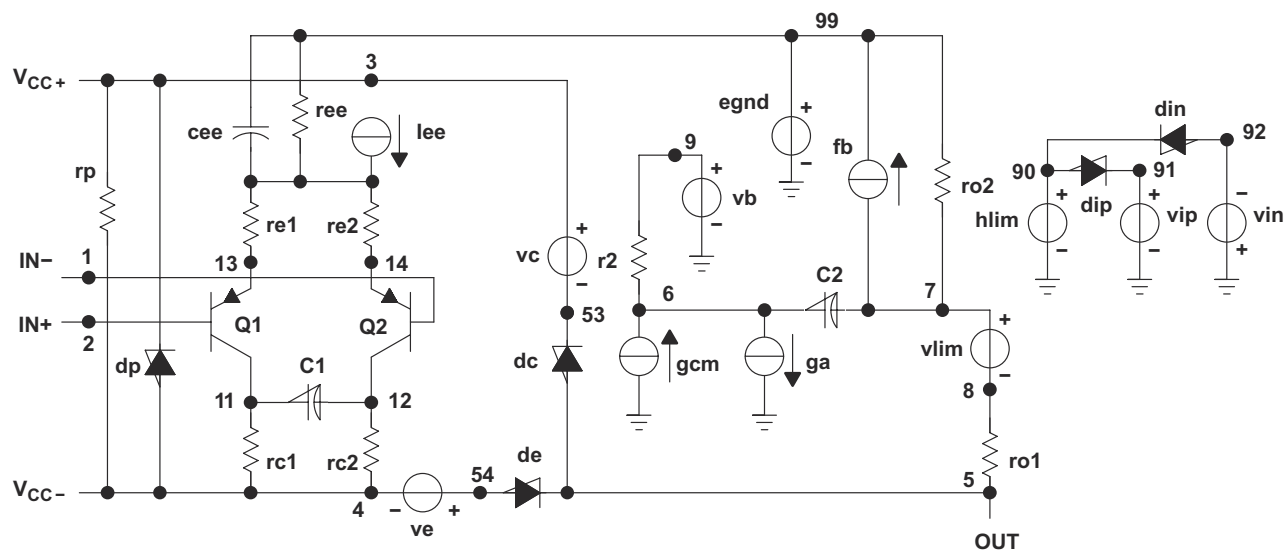


Figure 8-3. Boyle Subcircuit

<sup>1</sup> G. R. Boyle, B. M. Cohn, D. O. Pederson, and J. E. Solomon, "Macromodeling of Integrated Circuit Operational Amplifiers", *IEEE Journal of Solid-State Circuits*, SC-9, 353 (1974).

```

.SUBCKT TLE2021 1 2 3 4 5
*
c111126.244E      ! 12
c26713.4E         ! 12
c387010.64E       ! 9
cpsr858615.9E     ! 9
dcm+8182dx
dcm! 8381dx
dc553dx
de545dx
dlp9091dx
dln9290dx
dp43dx
ecmr8499(2 99) 1
egnd990poly(2) (3,0) (4,0) 0 .5 .5
epsr850poly(1) (3,4)      ! 60E! 6 2.0E! 6
ense892poly(1) (88,0) 120E      ! 6 1
fb799poly(6) vb vc ve vlp vln vpsr 0 547.3E6
+ ! 50E7 50E7 50E7 ! 50E7 547E6
ga6011 12 188.5E      ! 6
gcm0610 99 335.2E     ! 12
gpsr8586(85,86) 100E   ! 6
grc1411(4,11) 1.885E  ! 4
grc2412(4,12) 1.885E  ! 4
gre11310(13,10) 6.82E ! 4
gre21410(14,10) 6.82E ! 4
hlim900vlim 1k

hcmr801poly(2) vcm+ vcm      ! 0 1E2 1E2
irp34185E      ! 6
iee310dc 15.67E      ! 6
iio202E        ! 9
i18801E        ! 21
q1118913 qx
q2128014 qx
R269100.0E3
rcm 84811K
ree109914.76E6
rn18702.55E8
rn2878811.67E3
ro18562
ro279963
vcm+829913.3
vcm! 8399      ! 14.6
vb90dc 0
vc353dc 1.300
ve544dc 1.500
vlim78dc 0
vlp910dc 3.600
vln092dc 3.600
vpsr086dc 0
.model dx d(is=800.0E! 18)
.model qx pnp(is=800.0E! 18 bf=270)
.ends

```

**Figure 8-4. Boyle Macromodel for the TLE2021xM**

```

.SUBCKT TLE2022 1 2 3 4 5
*
c11112 6.814E      ! 12
c26720.00E         ! 12
dc553 dx
de545 dx
dlp9091 dx
dln9290 dx
dp43 dx
egnd 990poly(2) (3,0) (4,0) 0 .5 .5
fb799poly(5) vb vc ve vlp vln 0
+ 45.47E6      ! 50E6 50E6 50E6      ! 50E6
ga 6011 12 377.9E      ! 6
gcm 0610 99 7.84E      ! 10
iee310 DC 18.07E      ! 6
hlim 900 vlim 1k
q1112 13 qx
q2121 14 qx
r269 100.0E3

rc1411 2.842E3
rc2412 2.842E3
ge11310 (10,13) 31.299E      ! 3
ge21410 (10,14) 31.299E      ! 3
ree1099 11.07E6
ro185 250
ro2799 250
rp34 137.2E3
vb90 dc 0
vc353 dc 1.300
ve544 dc 1.500
vlim78 dc 0
vlp910 dc 3
vln092 dc 3
.model dx d(is=800.0E      ! 18)
.model qx pnp(is=800.0E      ! 18 bf=257.1)
.ends

```

**Figure 8-5. Boyle Macromodel for the TLE2022xM**

## 9 Device and Documentation Support

TI offers an extensive line of development tools. Tools and software to evaluate the performance of the device, generate code, and develop solutions are listed below.

### 9.1 Receiving Notification of Documentation Updates

To receive notification of documentation updates, navigate to the device product folder on [ti.com](http://ti.com). Click on *Notifications* to register and receive a weekly digest of any product information that has changed. For change details, review the revision history included in any revised document.

### 9.2 Support Resources

[TI E2E™ support forums](#) are an engineer's go-to source for fast, verified answers and design help — straight from the experts. Search existing answers or ask your own question to get the quick design help you need.

Linked content is provided "AS IS" by the respective contributors. They do not constitute TI specifications and do not necessarily reflect TI's views; see TI's [Terms of Use](#).

### 9.3 Trademarks

Microsim Parts™ and PSpice™ are trademarks of Cadence Design Systems, Inc..

TI E2E™ is a trademark of Texas Instruments.

All trademarks are the property of their respective owners.

### 9.4 Electrostatic Discharge Caution



This integrated circuit can be damaged by ESD. Texas Instruments recommends that all integrated circuits be handled with appropriate precautions. Failure to observe proper handling and installation procedures can cause damage.

ESD damage can range from subtle performance degradation to complete device failure. Precision integrated circuits may be more susceptible to damage because very small parametric changes could cause the device not to meet its published specifications.

### 9.5 Glossary

[TI Glossary](#) This glossary lists and explains terms, acronyms, and definitions.

## 10 Revision History

NOTE: Page numbers for previous revisions may differ from page numbers in the current version.

<b>Changes from Revision D (November 2010) to Revision E (July 2025)</b>	<b>Page</b>
• Deleted obsolete Y-suffix device and associated content from data sheet.....	<a href="#">1</a>
• Deleted DB and PW packages and associated content from data sheet.....	<a href="#">1</a>
• Moved D, DW, N, and P devices and associated content to SLVSJD7.....	<a href="#">1</a>
• Updated the numbering format for tables, figures, and cross-references throughout the document.....	<a href="#">1</a>
• Added application circuit to <i>Description</i> .....	<a href="#">1</a>

## 11 Mechanical, Packaging, and Orderable Information

The following pages include mechanical, packaging, and orderable information. This information is the most current data available for the designated devices. This data is subject to change without notice and revision of this document. For browser-based versions of this data sheet, refer to the left-hand navigation.

## PACKAGING INFORMATION

Orderable part number	Status (1)	Material type (2)	Package   Pins	Package qty   Carrier	RoHS (3)	Lead finish/ Ball material (4)	MSL rating/ Peak reflow (5)	Op temp (°C)	Part marking (6)
<a href="#">5962-9088101MPA</a>	Active	Production	CDIP (JG)   8	50   TUBE	No	SNPB	N/A for Pkg Type	-55 to 125	9088101MPA TLE2021M
<a href="#">5962-9088102M2A</a>	Active	Production	LCCC (FK)   20	55   TUBE	No	SNPB	N/A for Pkg Type	-55 to 125	5962- 9088102M2A TLE2022MFKB
<a href="#">5962-9088102MPA</a>	Active	Production	CDIP (JG)   8	50   TUBE	No	SNPB	N/A for Pkg Type	-55 to 125	9088102MPA TLE2022M
<a href="#">5962-9088103M2A</a>	Active	Production	LCCC (FK)   20	55   TUBE	No	SNPB	N/A for Pkg Type	-55 to 125	5962- 9088103M2A TLE2024MFKB
<a href="#">5962-9088103MCA</a>	Active	Production	CDIP (J)   14	25   TUBE	No	SNPB	N/A for Pkg Type	-55 to 125	5962-9088103MC A TLE2024MJB
<a href="#">5962-9088104Q2A</a>	Active	Production	LCCC (FK)   20	55   TUBE	No	SNPB	N/A for Pkg Type	-55 to 125	5962- 9088104Q2A TLE2021 AMFKB
<a href="#">5962-9088104QPA</a>	Active	Production	CDIP (JG)   8	50   TUBE	No	SNPB	N/A for Pkg Type	-55 to 125	9088104QPA TLE2021AM
<a href="#">5962-9088105Q2A</a>	Active	Production	LCCC (FK)   20	55   TUBE	No	SNPB	N/A for Pkg Type	-55 to 125	5962- 9088105Q2A TLE2022A MFKB
<a href="#">5962-9088105QPA</a>	Active	Production	CDIP (JG)   8	50   TUBE	No	SNPB	N/A for Pkg Type	-55 to 125	9088105QPA TLE2022AM
<a href="#">5962-9088106Q2A</a>	Active	Production	LCCC (FK)   20	55   TUBE	No	SNPB	N/A for Pkg Type	-55 to 125	5962- 9088106Q2A TLE2024A MFKB
<a href="#">5962-9088106QCA</a>	Active	Production	CDIP (J)   14	25   TUBE	No	SNPB	N/A for Pkg Type	-55 to 125	5962-9088106QC A TLE2024AMJB

Orderable part number	Status (1)	Material type (2)	Package   Pins	Package qty   Carrier	RoHS (3)	Lead finish/ Ball material (4)	MSL rating/ Peak reflow (5)	Op temp (°C)	Part marking (6)
<a href="#">5962-9088107Q2A</a>	Active	Production	LCCC (FK)   20	55   TUBE	No	SNPB	N/A for Pkg Type	-55 to 125	5962-9088107Q2A TLE2021 BMFKB
<a href="#">5962-9088107QPA</a>	Active	Production	CDIP (JG)   8	50   TUBE	No	SNPB	N/A for Pkg Type	-55 to 125	9088107QPA TLE2021BM
<a href="#">5962-9088108Q2A</a>	Active	Production	LCCC (FK)   20	55   TUBE	No	SNPB	N/A for Pkg Type	-55 to 125	5962-9088108Q2A TLE2022B MFKB
<a href="#">5962-9088108QPA</a>	Active	Production	CDIP (JG)   8	50   TUBE	No	SNPB	N/A for Pkg Type	-55 to 125	9088108QPA TLE2022BM
<a href="#">5962-9088109Q2A</a>	Active	Production	LCCC (FK)   20	55   TUBE	No	SNPB	N/A for Pkg Type	-55 to 125	5962-9088109Q2A TLE2024 BMFKB
<a href="#">5962-9088109QCA</a>	Active	Production	CDIP (J)   14	25   TUBE	No	SNPB	N/A for Pkg Type	-55 to 125	5962-9088109QC A TLE2024BMJB
<a href="#">TLE2021AMFKB</a>	Active	Production	LCCC (FK)   20	55   TUBE	No	SNPB	N/A for Pkg Type	-55 to 125	5962-9088104Q2A TLE2021 AMFKB
TLE2021AMFKB.A	Active	Production	LCCC (FK)   20	55   TUBE	No	SNPB	N/A for Pkg Type	-55 to 125	5962-9088104Q2A TLE2021 AMFKB
<a href="#">TLE2021AMJGB</a>	Active	Production	CDIP (JG)   8	50   TUBE	No	SNPB	N/A for Pkg Type	-55 to 125	9088104QPA TLE2021AM
TLE2021AMJGB.A	Active	Production	CDIP (JG)   8	50   TUBE	No	SNPB	N/A for Pkg Type	-55 to 125	9088104QPA TLE2021AM
<a href="#">TLE2021BMFKB</a>	Active	Production	LCCC (FK)   20	55   TUBE	No	SNPB	N/A for Pkg Type	-	5962-9088107Q2A TLE2021 BMFKB

Orderable part number	Status (1)	Material type (2)	Package   Pins	Package qty   Carrier	RoHS (3)	Lead finish/ Ball material (4)	MSL rating/ Peak reflow (5)	Op temp (°C)	Part marking (6)
TLE2021BMFKB.A	Active	Production	LCCC (FK)   20	55   TUBE	No	SNPB	N/A for Pkg Type	-55 to 125	5962- 9088107Q2A TLE2021 BMFKB
<a href="#">TLE2021BMJG</a>	Active	Production	CDIP (JG)   8	50   TUBE	No	SNPB	N/A for Pkg Type	-55 to 125	TLE2021 BMJG
TLE2021BMJG.A	Active	Production	CDIP (JG)   8	50   TUBE	No	SNPB	N/A for Pkg Type	-55 to 125	TLE2021 BMJG
<a href="#">TLE2021BMJGB</a>	Active	Production	CDIP (JG)   8	50   TUBE	No	SNPB	N/A for Pkg Type	-	9088107QPA TLE2021BM
TLE2021BMJGB.A	Active	Production	CDIP (JG)   8	50   TUBE	No	SNPB	N/A for Pkg Type	-55 to 125	9088107QPA TLE2021BM
<a href="#">TLE2021MJG</a>	Active	Production	CDIP (JG)   8	50   TUBE	No	SNPB	N/A for Pkg Type	-55 to 125	TLE2021MJG
TLE2021MJG.A	Active	Production	CDIP (JG)   8	50   TUBE	No	SNPB	N/A for Pkg Type	-55 to 125	TLE2021MJG
<a href="#">TLE2021MJGB</a>	Active	Production	CDIP (JG)   8	50   TUBE	No	SNPB	N/A for Pkg Type	-55 to 125	9088101MPA TLE2021M
TLE2021MJGB.A	Active	Production	CDIP (JG)   8	50   TUBE	No	SNPB	N/A for Pkg Type	-55 to 125	9088101MPA TLE2021M
<a href="#">TLE2022AMFKB</a>	Active	Production	LCCC (FK)   20	55   TUBE	No	SNPB	N/A for Pkg Type	-55 to 125	5962- 9088105Q2A TLE2022A MFKB
TLE2022AMFKB.A	Active	Production	LCCC (FK)   20	55   TUBE	No	SNPB	N/A for Pkg Type	-55 to 125	5962- 9088105Q2A TLE2022A MFKB
<a href="#">TLE2022AMJGB</a>	Active	Production	CDIP (JG)   8	50   TUBE	No	SNPB	N/A for Pkg Type	-55 to 125	9088105QPA TLE2022AM
TLE2022AMJGB.A	Active	Production	CDIP (JG)   8	50   TUBE	No	SNPB	N/A for Pkg Type	-55 to 125	9088105QPA TLE2022AM
<a href="#">TLE2022BMFKB</a>	Active	Production	LCCC (FK)   20	55   TUBE	No	SNPB	N/A for Pkg Type	-55 to 125	5962- 9088108Q2A TLE2022B MFKB



Orderable part number	Status (1)	Material type (2)	Package   Pins	Package qty   Carrier	RoHS (3)	Lead finish/ Ball material (4)	MSL rating/ Peak reflow (5)	Op temp (°C)	Part marking (6)
TLE2022BMFKB.A	Active	Production	LCCC (FK)   20	55   TUBE	No	SNPB	N/A for Pkg Type	-55 to 125	5962- 9088108Q2A TLE2022B MFKB
<a href="#">TLE2022BMJGB</a>	Active	Production	CDIP (JG)   8	50   TUBE	No	SNPB	N/A for Pkg Type	-55 to 125	9088108QPA TLE2022BM
TLE2022BMJGB.A	Active	Production	CDIP (JG)   8	50   TUBE	No	SNPB	N/A for Pkg Type	-55 to 125	9088108QPA TLE2022BM
<a href="#">TLE2022MFKB</a>	Active	Production	LCCC (FK)   20	55   TUBE	No	SNPB	N/A for Pkg Type	-55 to 125	5962- 9088102M2A TLE2022MFKB
TLE2022MFKB.A	Active	Production	LCCC (FK)   20	55   TUBE	No	SNPB	N/A for Pkg Type	-55 to 125	5962- 9088102M2A TLE2022MFKB
<a href="#">TLE2022MJG</a>	Active	Production	CDIP (JG)   8	50   TUBE	No	SNPB	N/A for Pkg Type	-55 to 125	TLE2022MJG
TLE2022MJG.A	Active	Production	CDIP (JG)   8	50   TUBE	No	SNPB	N/A for Pkg Type	-55 to 125	TLE2022MJG
<a href="#">TLE2022MJGB</a>	Active	Production	CDIP (JG)   8	50   TUBE	No	SNPB	N/A for Pkg Type	-55 to 125	9088102MPA TLE2022M
TLE2022MJGB.A	Active	Production	CDIP (JG)   8	50   TUBE	No	SNPB	N/A for Pkg Type	-55 to 125	9088102MPA TLE2022M
<a href="#">TLE2024AMFKB</a>	Active	Production	LCCC (FK)   20	55   TUBE	No	SNPB	N/A for Pkg Type	-55 to 125	5962- 9088106Q2A TLE2024A MFKB
TLE2024AMFKB.A	Active	Production	LCCC (FK)   20	55   TUBE	No	SNPB	N/A for Pkg Type	-55 to 125	5962- 9088106Q2A TLE2024A MFKB
<a href="#">TLE2024AMJB</a>	Active	Production	CDIP (J)   14	25   TUBE	No	SNPB	N/A for Pkg Type	-55 to 125	5962-9088106QC A TLE2024AMJB
TLE2024AMJB.A	Active	Production	CDIP (J)   14	25   TUBE	No	SNPB	N/A for Pkg Type	-55 to 125	5962-9088106QC A TLE2024AMJB

Orderable part number	Status (1)	Material type (2)	Package   Pins	Package qty   Carrier	RoHS (3)	Lead finish/ Ball material (4)	MSL rating/ Peak reflow (5)	Op temp (°C)	Part marking (6)
<a href="#">TLE2024BMFKB</a>	Active	Production	LCCC (FK)   20	55   TUBE	No	SNPB	N/A for Pkg Type	-55 to 125	5962-9088109Q2A TLE2024 BMFKB
TLE2024BMFKB.A	Active	Production	LCCC (FK)   20	55   TUBE	No	SNPB	N/A for Pkg Type	-55 to 125	5962-9088109Q2A TLE2024 BMFKB
<a href="#">TLE2024BMJ</a>	Active	Production	CDIP (J)   14	25   TUBE	No	SNPB	N/A for Pkg Type	-55 to 125	TLE2024BMJ
TLE2024BMJ.A	Active	Production	CDIP (J)   14	25   TUBE	No	SNPB	N/A for Pkg Type	-55 to 125	TLE2024BMJ
<a href="#">TLE2024BMJB</a>	Active	Production	CDIP (J)   14	25   TUBE	No	SNPB	N/A for Pkg Type	-55 to 125	5962-9088109QC A TLE2024BMJB
TLE2024BMJB.A	Active	Production	CDIP (J)   14	25   TUBE	No	SNPB	N/A for Pkg Type	-55 to 125	5962-9088109QC A TLE2024BMJB
<a href="#">TLE2024MFKB</a>	Active	Production	LCCC (FK)   20	55   TUBE	No	SNPB	N/A for Pkg Type	-55 to 125	5962-9088103M2A TLE2024MFKB
TLE2024MFKB.A	Active	Production	LCCC (FK)   20	55   TUBE	No	SNPB	N/A for Pkg Type	-55 to 125	5962-9088103M2A TLE2024MFKB
<a href="#">TLE2024MJB</a>	Active	Production	CDIP (J)   14	25   TUBE	No	SNPB	N/A for Pkg Type	-55 to 125	5962-9088103MC A TLE2024MJB
TLE2024MJB.A	Active	Production	CDIP (J)   14	25   TUBE	No	SNPB	N/A for Pkg Type	-55 to 125	5962-9088103MC A TLE2024MJB

<sup>(1)</sup> **Status:** For more details on status, see our [product life cycle](#).

<sup>(2)</sup> **Material type:** When designated, preproduction parts are prototypes/experimental devices, and are not yet approved or released for full production. Testing and final process, including without limitation quality assurance, reliability performance testing, and/or process qualification, may not yet be complete, and this item is subject to further changes or possible discontinuation. If available for ordering, purchases will be subject to an additional waiver at checkout, and are intended for early internal evaluation purposes only. These items are sold without warranties of any kind.

<sup>(3)</sup> **RoHS values:** Yes, No, RoHS Exempt. See the [TI RoHS Statement](#) for additional information and value definition.

(4) **Lead finish/Ball material:** Parts may have multiple material finish options. Finish options are separated by a vertical ruled line. Lead finish/Ball material values may wrap to two lines if the finish value exceeds the maximum column width.

(5) **MSL rating/Peak reflow:** The moisture sensitivity level ratings and peak solder (reflow) temperatures. In the event that a part has multiple moisture sensitivity ratings, only the lowest level per JEDEC standards is shown. Refer to the shipping label for the actual reflow temperature that will be used to mount the part to the printed circuit board.

(6) **Part marking:** There may be an additional marking, which relates to the logo, the lot trace code information, or the environmental category of the part.

Multiple part markings will be inside parentheses. Only one part marking contained in parentheses and separated by a "~" will appear on a part. If a line is indented then it is a continuation of the previous line and the two combined represent the entire part marking for that device.

**Important Information and Disclaimer:** The information provided on this page represents TI's knowledge and belief as of the date that it is provided. TI bases its knowledge and belief on information provided by third parties, and makes no representation or warranty as to the accuracy of such information. Efforts are underway to better integrate information from third parties. TI has taken and continues to take reasonable steps to provide representative and accurate information but may not have conducted destructive testing or chemical analysis on incoming materials and chemicals. TI and TI suppliers consider certain information to be proprietary, and thus CAS numbers and other limited information may not be available for release.

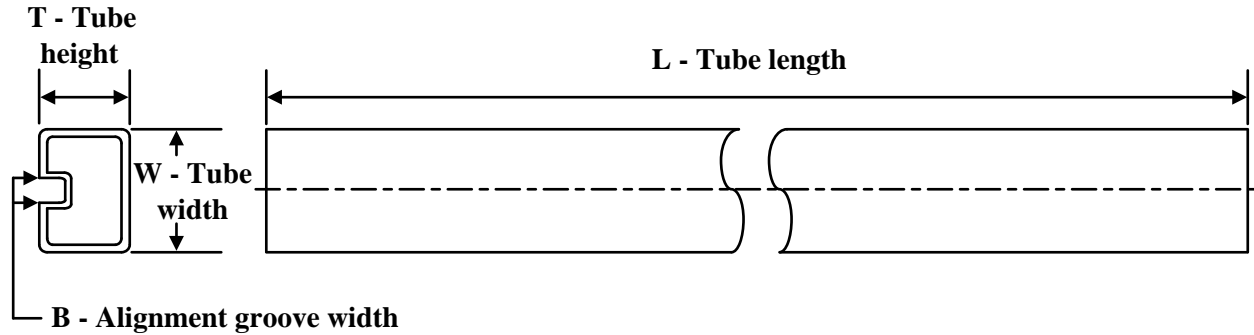
In no event shall TI's liability arising out of such information exceed the total purchase price of the TI part(s) at issue in this document sold by TI to Customer on an annual basis.

**OTHER QUALIFIED VERSIONS OF TLE2021AM, TLE2024AM, TLE2024M :**

- Catalog : [TLE2021A](#), [TLE2024A](#), [TLE2024](#)
- Automotive : [TLE2021A-Q1](#), [TLE2024-Q1](#)
- Enhanced Product : [TLE2021A-EP](#), [TLE2024A-EP](#), [TLE2024-EP](#)

NOTE: Qualified Version Definitions:

- Catalog - TI's standard catalog product
- Automotive - Q100 devices qualified for high-reliability automotive applications targeting zero defects
- Enhanced Product - Supports Defense, Aerospace and Medical Applications

**TUBE**


\*All dimensions are nominal

Device	Package Name	Package Type	Pins	SPQ	L (mm)	W (mm)	T (μm)	B (mm)
5962-9088102M2A	FK	LCCC	20	55	506.98	12.06	2030	NA
5962-9088103M2A	FK	LCCC	20	55	506.98	12.06	2030	NA
5962-9088104Q2A	FK	LCCC	20	55	506.98	12.06	2030	NA
5962-9088105Q2A	FK	LCCC	20	55	506.98	12.06	2030	NA
5962-9088106Q2A	FK	LCCC	20	55	506.98	12.06	2030	NA
5962-9088107Q2A	FK	LCCC	20	55	506.98	12.06	2030	NA
5962-9088108Q2A	FK	LCCC	20	55	506.98	12.06	2030	NA
5962-9088109Q2A	FK	LCCC	20	55	506.98	12.06	2030	NA
TLE2021AMFKB	FK	LCCC	20	55	506.98	12.06	2030	NA
TLE2021AMFKB.A	FK	LCCC	20	55	506.98	12.06	2030	NA
TLE2021BMFKB	FK	LCCC	20	55	506.98	12.06	2030	NA
TLE2021BMFKB.A	FK	LCCC	20	55	506.98	12.06	2030	NA
TLE2022AMFKB	FK	LCCC	20	55	506.98	12.06	2030	NA
TLE2022AMFKB.A	FK	LCCC	20	55	506.98	12.06	2030	NA
TLE2022BMFKB	FK	LCCC	20	55	506.98	12.06	2030	NA
TLE2022BMFKB.A	FK	LCCC	20	55	506.98	12.06	2030	NA
TLE2022MFKB	FK	LCCC	20	55	506.98	12.06	2030	NA
TLE2022MFKB.A	FK	LCCC	20	55	506.98	12.06	2030	NA
TLE2024AMFKB	FK	LCCC	20	55	506.98	12.06	2030	NA
TLE2024AMFKB.A	FK	LCCC	20	55	506.98	12.06	2030	NA
TLE2024BMFKB	FK	LCCC	20	55	506.98	12.06	2030	NA
TLE2024BMFKB.A	FK	LCCC	20	55	506.98	12.06	2030	NA
TLE2024MFKB	FK	LCCC	20	55	506.98	12.06	2030	NA
TLE2024MFKB.A	FK	LCCC	20	55	506.98	12.06	2030	NA

## GENERIC PACKAGE VIEW

**FK 20**

**LCCC - 2.03 mm max height**

8.89 x 8.89, 1.27 mm pitch

LEADLESS CERAMIC CHIP CARRIER

This image is a representation of the package family, actual package may vary.  
Refer to the product data sheet for package details.



4229370VA\

J 14

**GENERIC PACKAGE VIEW**  
**CDIP - 5.08 mm max height**  
CERAMIC DUAL IN LINE PACKAGE



Images above are just a representation of the package family, actual package may vary.  
Refer to the product data sheet for package details.

4040083-5/G

J0014A



# PACKAGE OUTLINE

CDIP - 5.08 mm max height

CERAMIC DUAL IN LINE PACKAGE



4214771/A 05/2017

NOTES:

1. All controlling linear dimensions are in inches. Dimensions in brackets are in millimeters. Any dimension in brackets or parenthesis are for reference only. Dimensioning and tolerancing per ASME Y14.5M.
2. This drawing is subject to change without notice.
3. This package is hermetically sealed with a ceramic lid using glass frit.
4. Index point is provided on cap for terminal identification only and on press ceramic glass frit seal only.
5. Falls within MIL-STD-1835 and GDIP1-T14.

# EXAMPLE BOARD LAYOUT

J0014A

CDIP - 5.08 mm max height

CERAMIC DUAL IN LINE PACKAGE



LAND PATTERN EXAMPLE  
NON-SOLDER MASK DEFINED  
SCALE: 5X



4214771/A 05/2017





# EXAMPLE BOARD LAYOUT

JG0008A

CDIP - 5.08 mm max height

CERAMIC DUAL IN-LINE PACKAGE



LAND PATTERN EXAMPLE  
NON SOLDER MASK DEFINED  
SCALE: 9X

4230036/A 09/2023

## IMPORTANT NOTICE AND DISCLAIMER

TI PROVIDES TECHNICAL AND RELIABILITY DATA (INCLUDING DATA SHEETS), DESIGN RESOURCES (INCLUDING REFERENCE DESIGNS), APPLICATION OR OTHER DESIGN ADVICE, WEB TOOLS, SAFETY INFORMATION, AND OTHER RESOURCES "AS IS" AND WITH ALL FAULTS, AND DISCLAIMS ALL WARRANTIES, EXPRESS AND IMPLIED, INCLUDING WITHOUT LIMITATION ANY IMPLIED WARRANTIES OF MERCHANTABILITY, FITNESS FOR A PARTICULAR PURPOSE OR NON-INFRINGEMENT OF THIRD PARTY INTELLECTUAL PROPERTY RIGHTS.

These resources are intended for skilled developers designing with TI products. You are solely responsible for (1) selecting the appropriate TI products for your application, (2) designing, validating and testing your application, and (3) ensuring your application meets applicable standards, and any other safety, security, regulatory or other requirements.

These resources are subject to change without notice. TI grants you permission to use these resources only for development of an application that uses the TI products described in the resource. Other reproduction and display of these resources is prohibited. No license is granted to any other TI intellectual property right or to any third party intellectual property right. TI disclaims responsibility for, and you will fully indemnify TI and its representatives against, any claims, damages, costs, losses, and liabilities arising out of your use of these resources.

TI's products are provided subject to [TI's Terms of Sale](#) or other applicable terms available either on [ti.com](https://www.ti.com) or provided in conjunction with such TI products. TI's provision of these resources does not expand or otherwise alter TI's applicable warranties or warranty disclaimers for TI products.

TI objects to and rejects any additional or different terms you may have proposed.

Mailing Address: Texas Instruments, Post Office Box 655303, Dallas, Texas 75265

Copyright © 2025, Texas Instruments Incorporated