

FEATURES

- Operating Voltage... ± 2 V to ± 18 V
- Low Offset Voltage...1 mV Max at 25°C, TL5580A
- Wide GBW...12 MHz Typ
- Slew Rate...5 V/ μ s Typ
- Low THD...0.0005% Typ
- Low-Noise Voltage...7 nV/ $\sqrt{\text{Hz}}$ at 1 kHz Typ

APPLICATIONS

- Audio
- Test Equipment
- Industrial Process Controls
- Data-Acquisition Systems
- Active Filters
- Power-Supply Regulation

D, P, OR PW PACKAGE
(TOP VIEW)

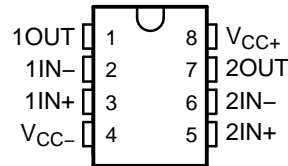

DESCRIPTION/ORDERING INFORMATION

The TL5580 is a dual bipolar operational amplifier that combines both high dc and ac performance with its low offset voltage, high-gain bandwidth, low harmonic distortion, and low-noise characteristics. In addition, its output is capable of driving 600- Ω loads. All these characteristics make the device ideally suited for use in audio, active filtering, and industrial measurement applications.

ORDERING INFORMATION

T_A	V_{IO} (25°C, MAX)	PACKAGE ⁽¹⁾		ORDERABLE PART NUMBER	TOP-SIDE MARKING
-40°C to 85°C	Standard grade 1.5 mV	PDIP – P	Tube of 50	TL5580IP	TL5580IP
		SOIC – D	Tube of 75	TL5580ID	Z5580
			Reel of 2500	TL5580IDR	
	A grade 1 mV	TSSOP – PW	Tube of 150	TL5580IPW	Z5580
			Reel of 2000	TL5580IPWR	
		PDIP – P	Tube of 50	TL5580AIP	TL5580AIP
SOIC – D	Tube of 75		TL5580AID	Z5580A	
	Reel of 2500		TL5580AIDR		
TSSOP – PW	Tube of 150	TL5580AIPW	Z5580A		
	Reel of 2000	TL5580AIPWR			

(1) Package drawings, standard packing quantities, thermal data, symbolization, and PCB design guidelines are available at www.ti.com/sc/package.



Please be aware that an important notice concerning availability, standard warranty, and use in critical applications of Texas Instruments semiconductor products and disclaimers thereto appears at the end of this data sheet.

TL5580, TL5580A DUAL LOW-NOISE WIDE-BANDWIDTH PRECISION AMPLIFIER

SLOS477A–JUNE 2005–REVISED JULY 2005

EQUIVALENT SCHEMATIC

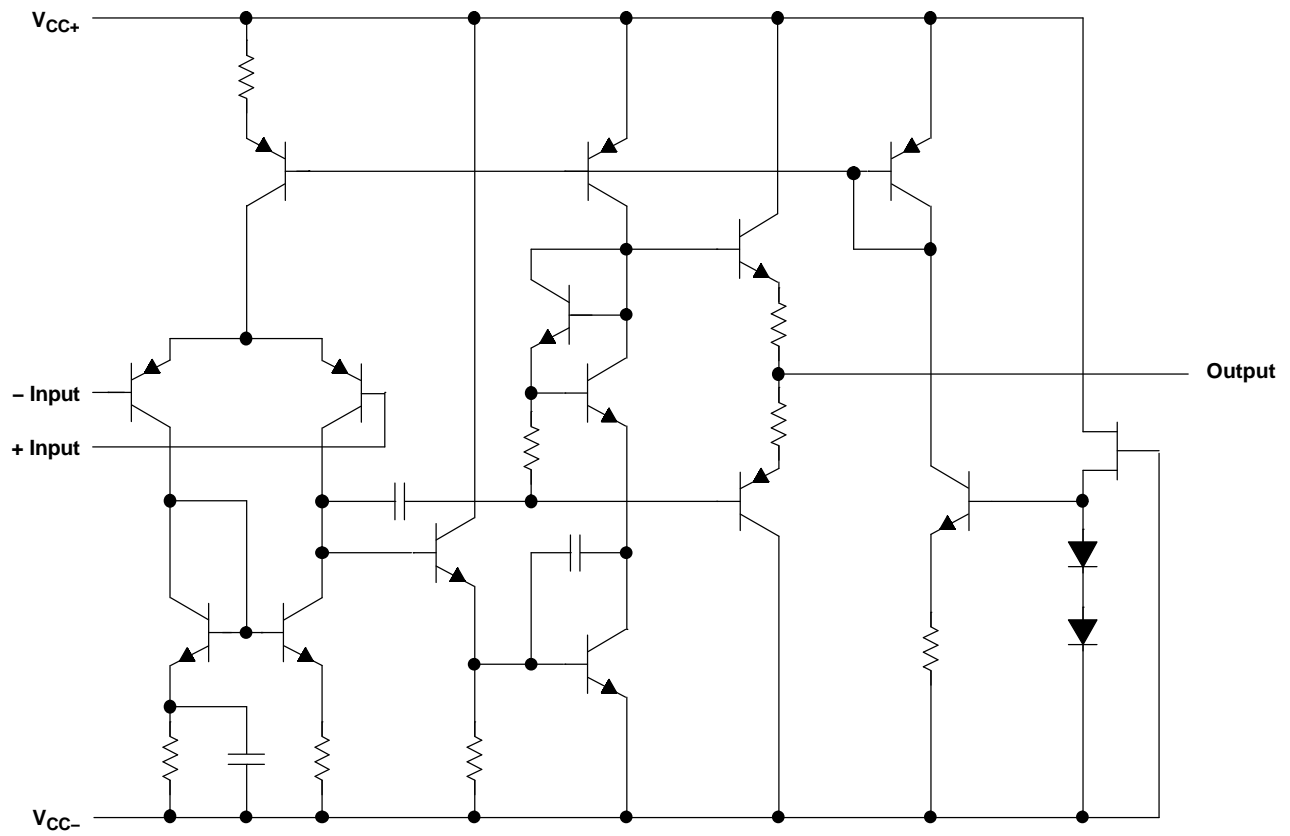

Absolute Maximum Ratings⁽¹⁾

over operating free-air temperature range (unless otherwise noted)

		MIN	MAX	UNIT
$V_{CC\pm}$	Supply voltage		±18	V
V_I	Input voltage (any input)		±15	V
V_{ID}	Differential input voltage		±30	V
I_O	Output current		±50	mA
θ_{JA}	Package thermal impedance ⁽²⁾⁽³⁾	D package	97	°C/W
		P package	85	
		PW package	149	
T_J	Operating virtual junction temperature		150	°C
T_{stg}	Storage temperature range	–60	125	°C

- (1) Stresses beyond those listed under “absolute maximum ratings” may cause permanent damage to the device. These are stress ratings only, and functional operation of the device at these or any other conditions beyond those indicated under “recommended operating conditions” is not implied. Exposure to absolute-maximum-rated conditions for extended periods may affect device reliability.
- (2) Maximum power dissipation is a function of $T_J(\text{max})$, θ_{JA} , and T_A . The maximum allowable power dissipation at any allowable ambient temperature is $P_D = (T_J(\text{max}) - T_A)/\theta_{JA}$. Operating at the absolute maximum T_J of 150°C can affect reliability.
- (3) The package thermal impedance is calculated in accordance with JESD 51-7.

Recommended Operating Conditions

		MIN	MAX	UNIT
V_{CC+}	Supply voltage	2	16	V
V_{CC-}		–2	–16	
T_A	Operating free-air temperature	–40	85	°C

TL5580, TL5580A DUAL LOW-NOISE WIDE-BANDWIDTH PRECISION AMPLIFIER

SLOS477A–JUNE 2005–REVISED JULY 2005

Electrical Characteristics

$V_{CC\pm} = \pm 15\text{ V}$ (unless otherwise noted)

PARAMETER		TEST CONDITIONS	T_A	MIN	TYP	MAX	UNIT
V_{IO}	Input offset voltage	$R_S \leq 10\text{ k}\Omega$	25°C	0.3	1		mV
			–40°C to 85°C		1.35		
			25°C	0.3	1.5		
			–40°C to 85°C		2		
αV_{IO}	Average temperature coefficient of input offset voltage		–40°C to 85°C	1.8	5		$\mu\text{V}/^\circ\text{C}$
I_{IO}	Input offset current		25°C	5	75		nA
			–40°C to 85°C		100		
I_{IB}	Input bias current		25°C	100	500		nA
			–40°C to 85°C		800		
A_{VD}	Large-signal differential-voltage amplification	$R_L \geq 2\text{ k}\Omega$, $V_O = \pm 10\text{ V}$	25°C	90	110		dB
			–40°C to 85°C		87		
V_{OM}	Output voltage swing	$R_L \geq 2\text{ k}\Omega$	25°C	12.75 – 12.25	± 13.5		V
			–40°C to 85°C		12.5 – 12		
V_{ICR}	Common-mode input voltage range		25°C	± 13	± 13.5		V
			–40°C to 85°C		± 12		
CMRR	Common-mode rejection ratio	$R_S \leq 10\text{ k}\Omega$, $V_{ICR} = -12\text{ V to } 12\text{ V}$	25°C	90	110		dB
			–40°C to 85°C		85		
$k_{SVR}^{(1)}$	Supply-voltage rejection ratio	$R_S \leq 10\text{ k}\Omega$	25°C	85	110		dB
			–40°C to 85°C		83		
I_{CC}	Supply current (all amplifiers)		25°C	6	9		mA
			–40°C to 85°C		12		

(1) Measured with $V_{CC\pm}$ varied simultaneously

Operating Characteristics

$V_{CC\pm} = \pm 15\text{ V}$, $T_A = 25^\circ\text{C}$ (unless otherwise noted)

PARAMETER		TEST CONDITIONS	TYP	UNIT
SR	Slew rate at unity gain	$R_L \geq 2\text{ k}\Omega$	5	$\text{V}/\mu\text{s}$
GBW	Gain bandwidth product	$f = 10\text{ kHz}$	12	MHz
THD	Total harmonic distortion	$V_O = 5\text{ V}$, $R_L = 2\text{ k}\Omega$, $f = 1\text{ kHz}$, $A_{VD} = 20\text{ dB}$	0.0005	%
V_n	Equivalent input noise voltage	$f = 1\text{ kHz}$	7	$\text{nV}/\sqrt{\text{Hz}}$

TYPICAL CHARACTERISTICS

MAXIMUM OUTPUT VOLTAGE SWING
VS
LOAD RESISTANCE

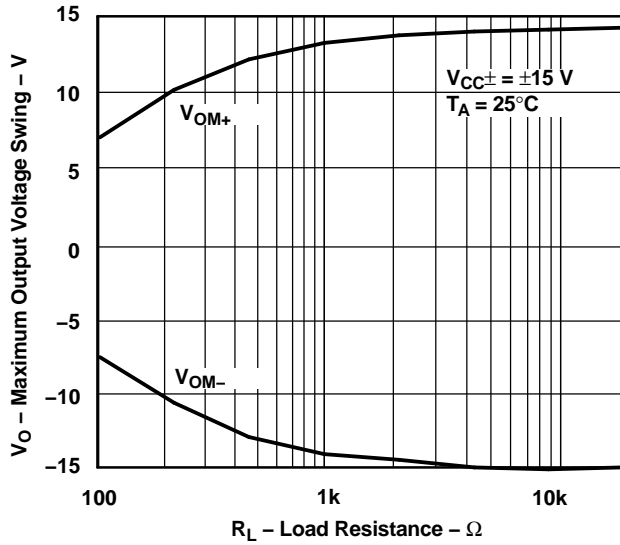

Figure 1.

MAXIMUM OUTPUT VOLTAGE SWING
VS
FREQUENCY

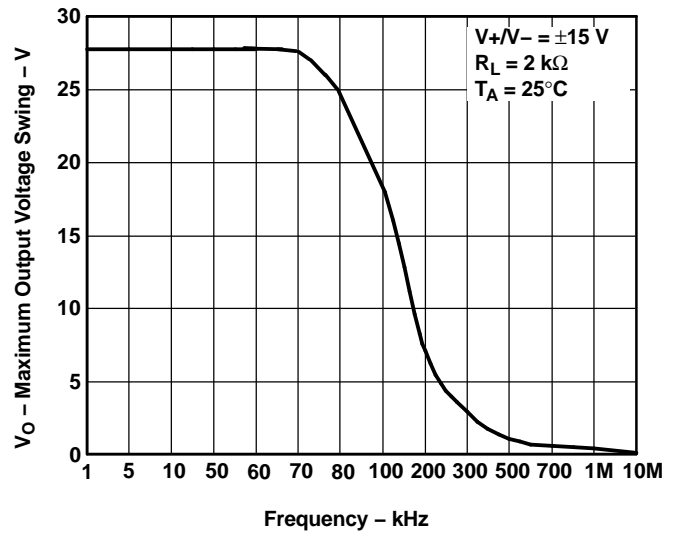

Figure 2.

OUTPUT VOLTAGE SWING
VS
OUTPUT CURRENT

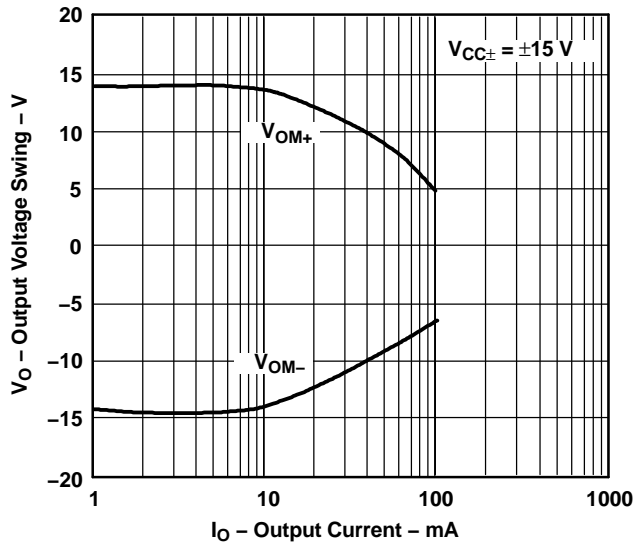

Figure 3.

EQUIVALENT INPUT NOISE VOLTAGE
VS
FREQUENCY

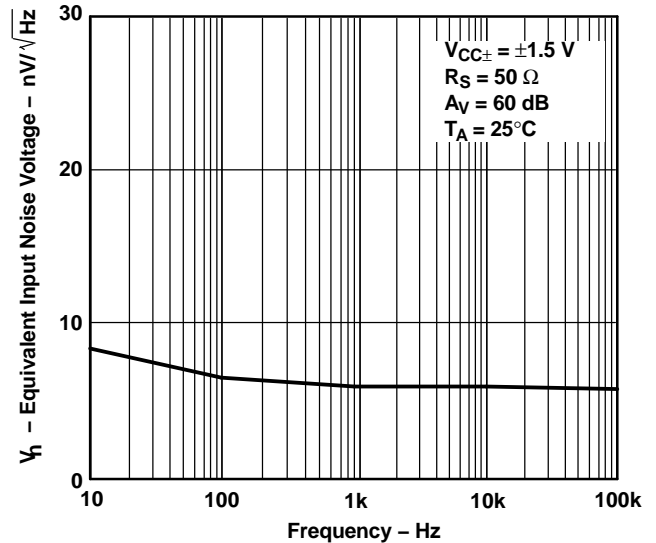

Figure 4.

TYPICAL CHARACTERISTICS (continued)

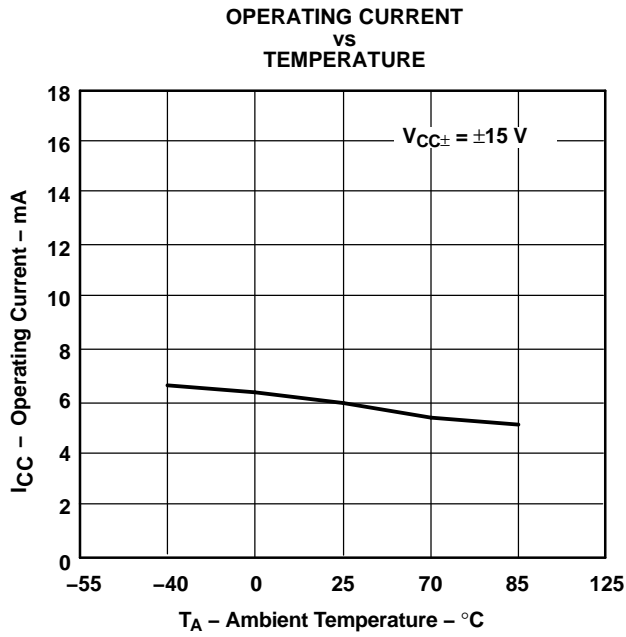

Figure 5.

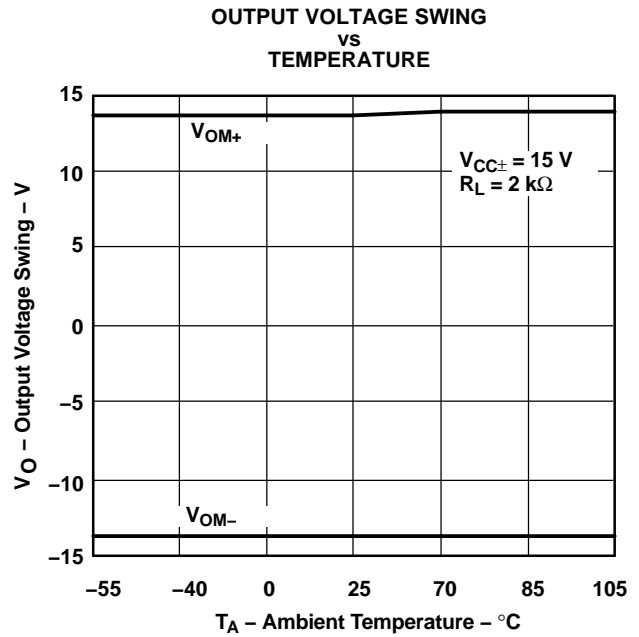

Figure 6.

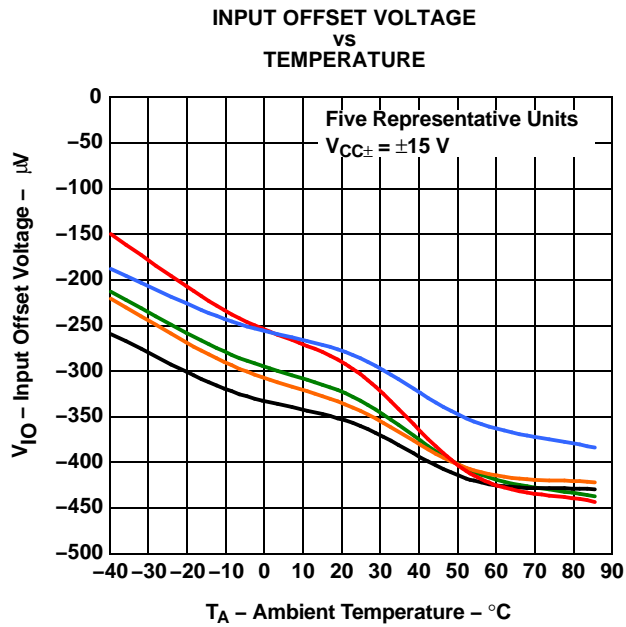

Figure 7.

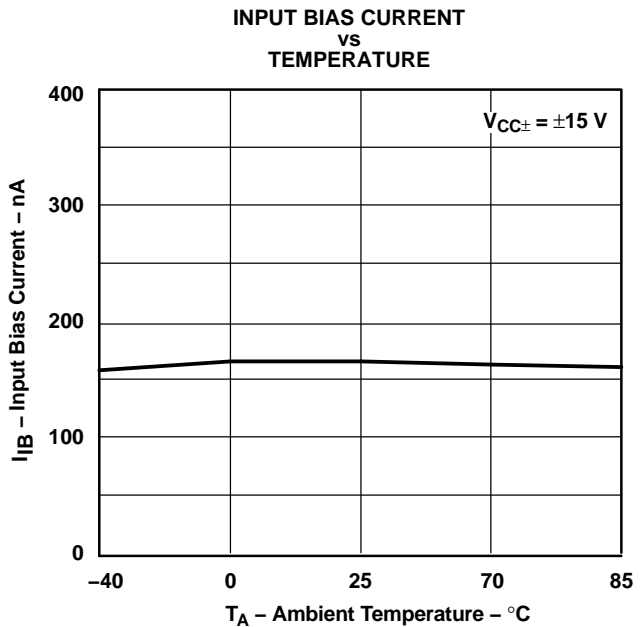

Figure 8.

TYPICAL CHARACTERISTICS (continued)

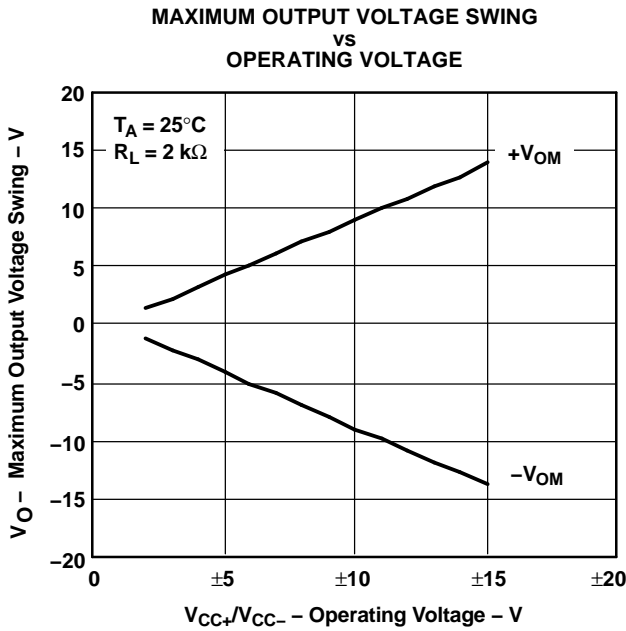

Figure 9.

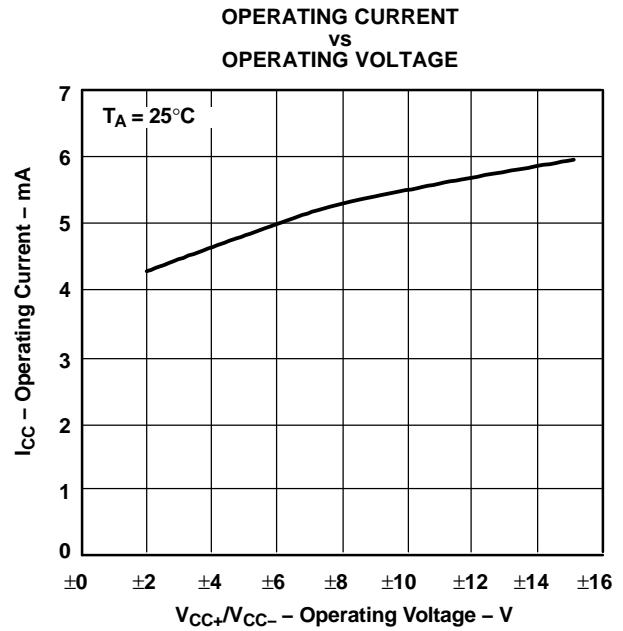

Figure 10.

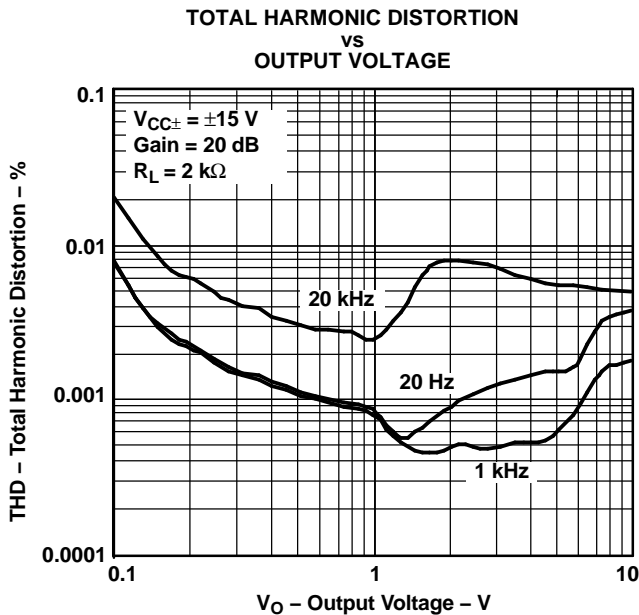

Figure 11.

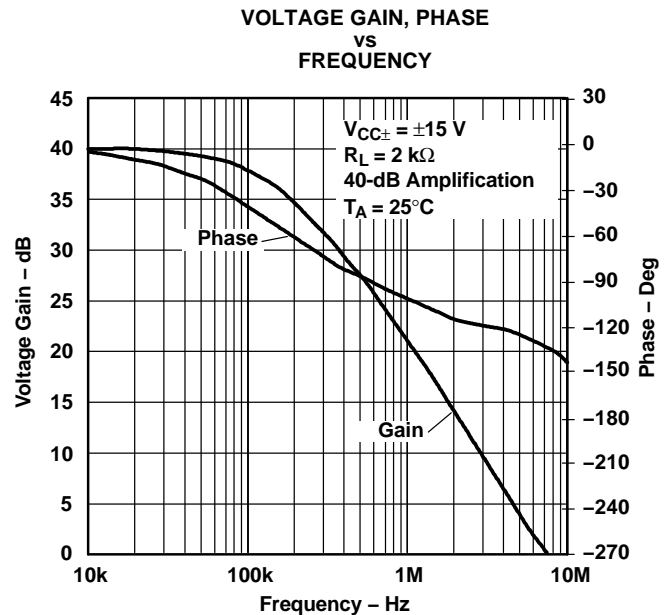

Figure 12.

PACKAGING INFORMATION

Orderable part number	Status (1)	Material type (2)	Package Pins	Package qty Carrier	RoHS (3)	Lead finish/ Ball material (4)	MSL rating/ Peak reflow (5)	Op temp (°C)	Part marking (6)
TL5580AID	Obsolete	Production	SOIC (D) 8	-	-	Call TI	Call TI	-40 to 85	Z5580A
TL5580AIDR	Active	Production	SOIC (D) 8	2500 LARGE T&R	Yes	NIPDAU	Level-1-260C-UNLIM	-40 to 85	Z5580A
TL5580AIDR.A	Active	Production	SOIC (D) 8	2500 LARGE T&R	Yes	NIPDAU	Level-1-260C-UNLIM	-40 to 85	Z5580A
TL5580AIP	Active	Production	PDIP (P) 8	50 TUBE	Yes	NIPDAU	N/A for Pkg Type	-40 to 85	TL5580AIP
TL5580AIP.A	Active	Production	PDIP (P) 8	50 TUBE	Yes	NIPDAU	N/A for Pkg Type	-40 to 85	TL5580AIP
TL5580AIPWR	Active	Production	TSSOP (PW) 8	2000 LARGE T&R	Yes	NIPDAU	Level-1-260C-UNLIM	-40 to 85	Z5580A
TL5580AIPWR.A	Active	Production	TSSOP (PW) 8	2000 LARGE T&R	Yes	NIPDAU	Level-1-260C-UNLIM	-40 to 85	Z5580A
TL5580IDR	Active	Production	SOIC (D) 8	2500 LARGE T&R	Yes	NIPDAU	Level-1-260C-UNLIM	-40 to 85	Z5580
TL5580IDR.A	Active	Production	SOIC (D) 8	2500 LARGE T&R	Yes	NIPDAU	Level-1-260C-UNLIM	-40 to 85	Z5580
TL5580IDR.B	Active	Production	SOIC (D) 8	2500 LARGE T&R	-	Call TI	Call TI	-40 to 85	
TL5580IP	Active	Production	PDIP (P) 8	50 TUBE	Yes	NIPDAU	N/A for Pkg Type	-40 to 85	TL5580IP
TL5580IP.A	Active	Production	PDIP (P) 8	50 TUBE	Yes	NIPDAU	N/A for Pkg Type	-40 to 85	TL5580IP
TL5580IPWR	Active	Production	TSSOP (PW) 8	2000 LARGE T&R	Yes	NIPDAU	Level-1-260C-UNLIM	-40 to 85	Z5580
TL5580IPWR.A	Active	Production	TSSOP (PW) 8	2000 LARGE T&R	Yes	NIPDAU	Level-1-260C-UNLIM	-40 to 85	Z5580

(1) **Status:** For more details on status, see our [product life cycle](#).

(2) **Material type:** When designated, preproduction parts are prototypes/experimental devices, and are not yet approved or released for full production. Testing and final process, including without limitation quality assurance, reliability performance testing, and/or process qualification, may not yet be complete, and this item is subject to further changes or possible discontinuation. If available for ordering, purchases will be subject to an additional waiver at checkout, and are intended for early internal evaluation purposes only. These items are sold without warranties of any kind.

(3) **RoHS values:** Yes, No, RoHS Exempt. See the [TI RoHS Statement](#) for additional information and value definition.

(4) **Lead finish/Ball material:** Parts may have multiple material finish options. Finish options are separated by a vertical ruled line. Lead finish/Ball material values may wrap to two lines if the finish value exceeds the maximum column width.

(5) **MSL rating/Peak reflow:** The moisture sensitivity level ratings and peak solder (reflow) temperatures. In the event that a part has multiple moisture sensitivity ratings, only the lowest level per JEDEC standards is shown. Refer to the shipping label for the actual reflow temperature that will be used to mount the part to the printed circuit board.

(6) **Part marking:** There may be an additional marking, which relates to the logo, the lot trace code information, or the environmental category of the part.

Multiple part markings will be inside parentheses. Only one part marking contained in parentheses and separated by a "~" will appear on a part. If a line is indented then it is a continuation of the previous line and the two combined represent the entire part marking for that device.

Important Information and Disclaimer: The information provided on this page represents TI's knowledge and belief as of the date that it is provided. TI bases its knowledge and belief on information provided by third parties, and makes no representation or warranty as to the accuracy of such information. Efforts are underway to better integrate information from third parties. TI has taken and continues to take reasonable steps to provide representative and accurate information but may not have conducted destructive testing or chemical analysis on incoming materials and chemicals. TI and TI suppliers consider certain information to be proprietary, and thus CAS numbers and other limited information may not be available for release.

In no event shall TI's liability arising out of such information exceed the total purchase price of the TI part(s) at issue in this document sold by TI to Customer on an annual basis.

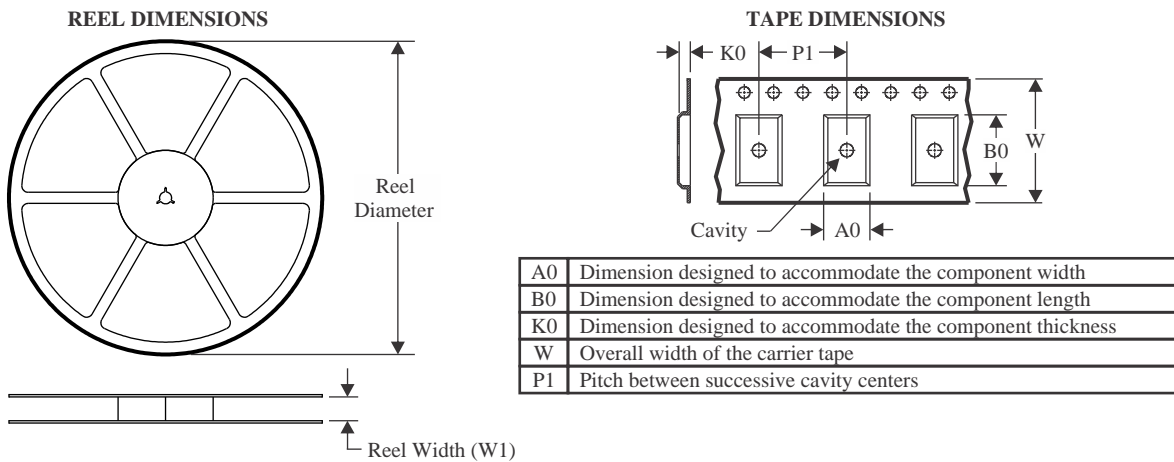
TAPE AND REEL INFORMATION

QUADRANT ASSIGNMENTS FOR PIN 1 ORIENTATION IN TAPE

*All dimensions are nominal

Device	Package Type	Package Drawing	Pins	SPQ	Reel Diameter (mm)	Reel Width W1 (mm)	A0 (mm)	B0 (mm)	K0 (mm)	P1 (mm)	W (mm)	Pin1 Quadrant
TL5580AIDR	SOIC	D	8	2500	330.0	12.4	6.4	5.2	2.1	8.0	12.0	Q1
TL5580AIPWR	TSSOP	PW	8	2000	330.0	12.4	7.0	3.6	1.6	8.0	12.0	Q1
TL5580IDR	SOIC	D	8	2500	330.0	12.4	6.4	5.2	2.1	8.0	12.0	Q1
TL5580IPWR	TSSOP	PW	8	2000	330.0	12.4	7.0	3.6	1.6	8.0	12.0	Q1

TAPE AND REEL BOX DIMENSIONS



*All dimensions are nominal

Device	Package Type	Package Drawing	Pins	SPQ	Length (mm)	Width (mm)	Height (mm)
TL5580AIDR	SOIC	D	8	2500	353.0	353.0	32.0
TL5580AIPWR	TSSOP	PW	8	2000	353.0	353.0	32.0
TL5580IDR	SOIC	D	8	2500	353.0	353.0	32.0
TL5580IPWR	TSSOP	PW	8	2000	353.0	353.0	32.0

TUBE

*All dimensions are nominal

Device	Package Name	Package Type	Pins	SPQ	L (mm)	W (mm)	T (μm)	B (mm)
TL5580AIP	P	PDIP	8	50	506	13.97	11230	4.32
TL5580AIP.A	P	PDIP	8	50	506	13.97	11230	4.32
TL5580IP	P	PDIP	8	50	506	13.97	11230	4.32
TL5580IP.A	P	PDIP	8	50	506	13.97	11230	4.32



D0008A

PACKAGE OUTLINE

SOIC - 1.75 mm max height

SMALL OUTLINE INTEGRATED CIRCUIT



4214825/C 02/2019

NOTES:

1. Linear dimensions are in inches [millimeters]. Dimensions in parenthesis are for reference only. Controlling dimensions are in inches. Dimensioning and tolerancing per ASME Y14.5M.
2. This drawing is subject to change without notice.
3. This dimension does not include mold flash, protrusions, or gate burrs. Mold flash, protrusions, or gate burrs shall not exceed $.006$ [0.15] per side.
4. This dimension does not include interlead flash.
5. Reference JEDEC registration MS-012, variation AA.

EXAMPLE BOARD LAYOUT

D0008A

SOIC - 1.75 mm max height

SMALL OUTLINE INTEGRATED CIRCUIT



LAND PATTERN EXAMPLE
 EXPOSED METAL SHOWN
 SCALE:8X



SOLDER MASK DETAILS

4214825/C 02/2019

NOTES: (continued)

- 6. Publication IPC-7351 may have alternate designs.
- 7. Solder mask tolerances between and around signal pads can vary based on board fabrication site.

EXAMPLE STENCIL DESIGN

D0008A

SOIC - 1.75 mm max height

SMALL OUTLINE INTEGRATED CIRCUIT



SOLDER PASTE EXAMPLE
BASED ON .005 INCH [0.125 MM] THICK STENCIL
SCALE:8X

4214825/C 02/2019

NOTES: (continued)

8. Laser cutting apertures with trapezoidal walls and rounded corners may offer better paste release. IPC-7525 may have alternate design recommendations.
9. Board assembly site may have different recommendations for stencil design.

P (R-PDIP-T8)

PLASTIC DUAL-IN-LINE PACKAGE



- NOTES:
- A. All linear dimensions are in inches (millimeters).
 - B. This drawing is subject to change without notice.
 - C. Falls within JEDEC MS-001 variation BA.

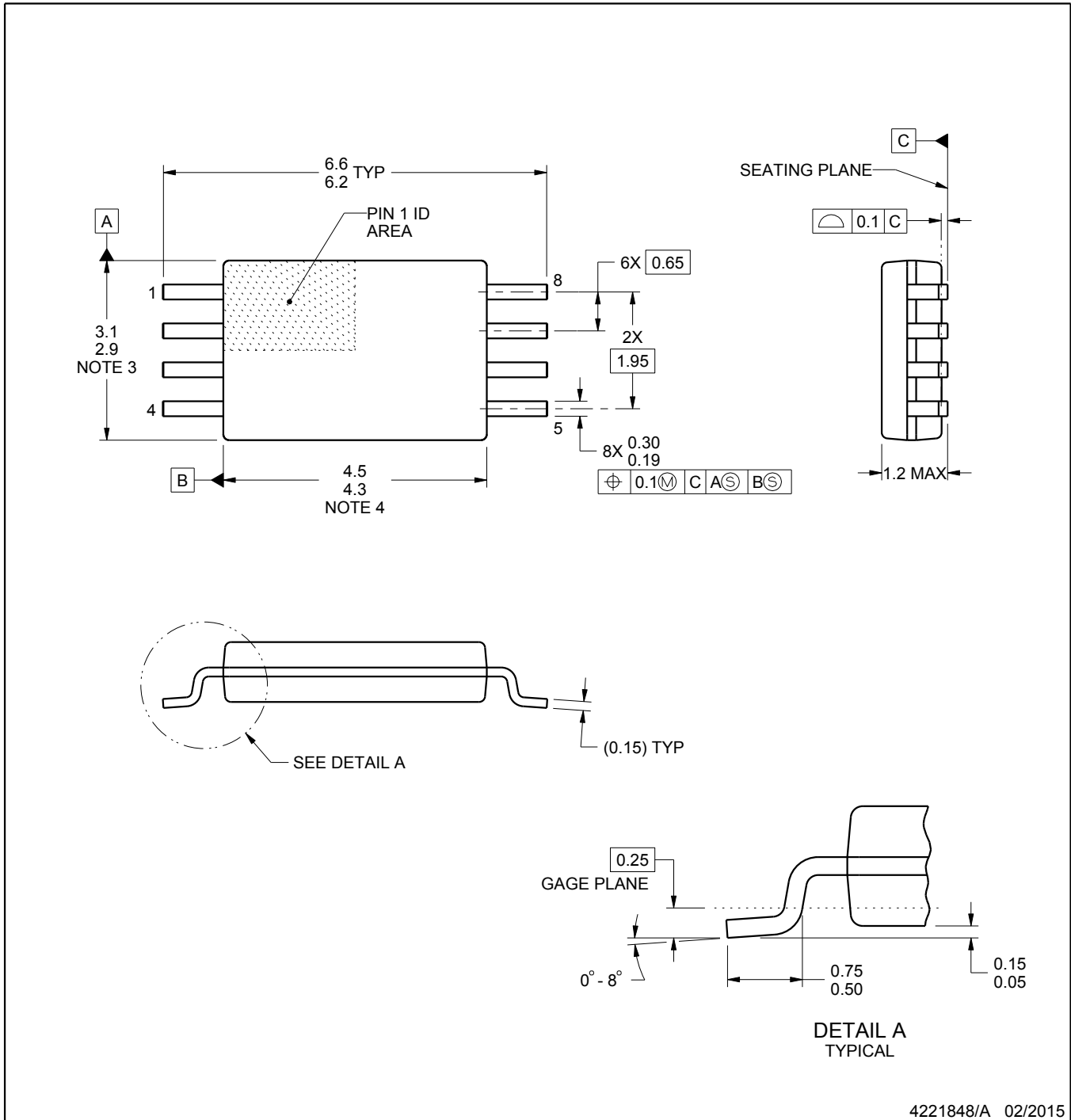

4221848/A 02/2015

NOTES:

1. All linear dimensions are in millimeters. Any dimensions in parenthesis are for reference only. Dimensioning and tolerancing per ASME Y14.5M.
2. This drawing is subject to change without notice.
3. This dimension does not include mold flash, protrusions, or gate burrs. Mold flash, protrusions, or gate burrs shall not exceed 0.15 mm per side.
4. This dimension does not include interlead flash. Interlead flash shall not exceed 0.25 mm per side.
5. Reference JEDEC registration MO-153, variation AA.

EXAMPLE BOARD LAYOUT

PW0008A

TSSOP - 1.2 mm max height

SMALL OUTLINE PACKAGE



LAND PATTERN EXAMPLE
SCALE:10X



SOLDER MASK DETAILS
NOT TO SCALE

4221848/A 02/2015

NOTES: (continued)

- 6. Publication IPC-7351 may have alternate designs.
- 7. Solder mask tolerances between and around signal pads can vary based on board fabrication site.

EXAMPLE STENCIL DESIGN

PW0008A

TSSOP - 1.2 mm max height

SMALL OUTLINE PACKAGE



SOLDER PASTE EXAMPLE
BASED ON 0.125 mm THICK STENCIL
SCALE:10X

4221848/A 02/2015

NOTES: (continued)

8. Laser cutting apertures with trapezoidal walls and rounded corners may offer better paste release. IPC-7525 may have alternate design recommendations.
9. Board assembly site may have different recommendations for stencil design.

IMPORTANT NOTICE AND DISCLAIMER

TI PROVIDES TECHNICAL AND RELIABILITY DATA (INCLUDING DATASHEETS), DESIGN RESOURCES (INCLUDING REFERENCE DESIGNS), APPLICATION OR OTHER DESIGN ADVICE, WEB TOOLS, SAFETY INFORMATION, AND OTHER RESOURCES "AS IS" AND WITH ALL FAULTS, AND DISCLAIMS ALL WARRANTIES, EXPRESS AND IMPLIED, INCLUDING WITHOUT LIMITATION ANY IMPLIED WARRANTIES OF MERCHANTABILITY, FITNESS FOR A PARTICULAR PURPOSE OR NON-INFRINGEMENT OF THIRD PARTY INTELLECTUAL PROPERTY RIGHTS.

These resources are intended for skilled developers designing with TI products. You are solely responsible for (1) selecting the appropriate TI products for your application, (2) designing, validating and testing your application, and (3) ensuring your application meets applicable standards, and any other safety, security, regulatory or other requirements.

These resources are subject to change without notice. TI grants you permission to use these resources only for development of an application that uses the TI products described in the resource. Other reproduction and display of these resources is prohibited. No license is granted to any other TI intellectual property right or to any third party intellectual property right. TI disclaims responsibility for, and you fully indemnify TI and its representatives against any claims, damages, costs, losses, and liabilities arising out of your use of these resources.

TI's products are provided subject to [TI's Terms of Sale](#), [TI's General Quality Guidelines](#), or other applicable terms available either on [ti.com](#) or provided in conjunction with such TI products. TI's provision of these resources does not expand or otherwise alter TI's applicable warranties or warranty disclaimers for TI products. Unless TI explicitly designates a product as custom or customer-specified, TI products are standard, catalog, general purpose devices.

TI objects to and rejects any additional or different terms you may propose.

Copyright © 2025, Texas Instruments Incorporated

Last updated 10/2025