

DUAL-BIT DUAL-SUPPLY BUS TRANSCEIVER WITH CONFIGURABLE VOLTAGE TRANSLATION AND 3-STATE OUTPUTS

Check for Samples: [SN74LVC2T45-EP](#)

FEATURES

- Available in the Texas Instruments NanoFree™ Package
- Fully Configurable Dual-Rail Design Allows Each Port to Operate Over the Full 1.65-V to 5.5-V Power-Supply Range
- V_{CC} Isolation Feature – If Either V_{CC} Input Is at GND, Both Ports Are in the High-Impedance State
- DIR Input Circuit Referenced to V_{CCA}
- Low Power Consumption, 10- μ A Max I_{CC}
- ± 24 -mA Output Drive at 3.3 V
- I_{off} Supports Partial-Power-Down Mode Operation
- Max Data Rates
 - 420 Mbps (3.3-V to 5-V Translation)
 - 210 Mbps (Translate to 3.3 V)
 - 140 Mbps (Translate to 2.5 V)
 - 75 Mbps (Translate to 1.8 V)
- Latch-Up Performance Exceeds 100 mA Per JESD 78, Class II
- ESD Protection Exceeds JESD 22
 - 4000-V Human-Body Model (A114-A)
 - 200-V Machine Model (A115-A)
 - 1000-V Charged-Device Model (C101)

SUPPORTS DEFENSE, AEROSPACE, AND MEDICAL APPLICATIONS

- Controlled Baseline
- One Assembly/Test Site
- One Fabrication Site
- Available Temperature Ranges:
 - -55°C to 125°C
 - -55°C to 150°C
- Extended Product Life Cycle
- Extended Product-Change Notification
- Product Traceability

DCT OR DCU PACKAGE
(TOP VIEW)

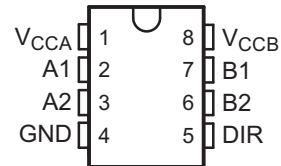

DESCRIPTION/ORDERING INFORMATION

This dual-bit noninverting bus transceiver uses two separate configurable power-supply rails. The A port is designed to track V_{CCA} . V_{CCA} accepts any supply voltage from 1.65 V to 5.5 V. The B port is designed to track V_{CCB} . V_{CCB} accepts any supply voltage from 1.65 V to 5.5 V. This allows for universal low-voltage bidirectional translation between any of the 1.8-V, 2.5-V, 3.3-V, and 5-V voltage nodes.

Table 1. ORDERING INFORMATION⁽¹⁾

T_A	PACKAGE ⁽²⁾		ORDERABLE PART NUMBER	TOP-SIDE MARKING
-55°C to 125°C	SSOP – DCT	Reel of 250	SN74LVC2T45MDCTTEP	NXR
-55°C to 150°C	SSOP – DCU	Reel of 250	SN74LVC2T45SDCUT	CCVR

(1) For the most current package and ordering information, see the Package Option Addendum at the end of this document, or see the TI website at www.ti.com.

(2) Package drawings, standard packing quantities, thermal data, symbolization, and PCB design guidelines are available at www.ti.com/sc/package.



Please be aware that an important notice concerning availability, standard warranty, and use in critical applications of Texas Instruments semiconductor products and disclaimers thereto appears at the end of this data sheet.

DESCRIPTION/ORDERING INFORMATION (CONTINUED)

The SN74LVC2T45 is designed for asynchronous communication between two data buses. The logic levels of the direction-control (DIR) input activate either the B-port outputs or the A-port outputs. The device transmits data from the A bus to the B bus when the B-port outputs are activated, and from the B bus to the A bus when the A-port outputs are activated. The input circuitry on both A and B ports always is active and must have a logic HIGH or LOW level applied to prevent excess I_{CC} and I_{CCZ} .

The SN74LVC2T45 is designed so that the DIR input circuit is supplied by V_{CCA} .

This device is fully specified for partial-power-down applications using I_{off} . The I_{off} circuitry disables the outputs, preventing damaging current backflow through the device when it is powered down.

The V_{CC} isolation feature ensures that if either V_{CC} input is at GND, both ports are in the high-impedance state.

NanoFree™ package technology is a major breakthrough in IC packaging concepts, using the die as the package.

**Table 2. FUNCTION TABLE⁽¹⁾
(EACH TRANSCEIVER)**

INPUT DIR	OPERATION
L	B data to A bus
H	A data to B bus

(1) Input circuits of the data I/Os always are active.

LOGIC DIAGRAM (POSITIVE LOGIC)

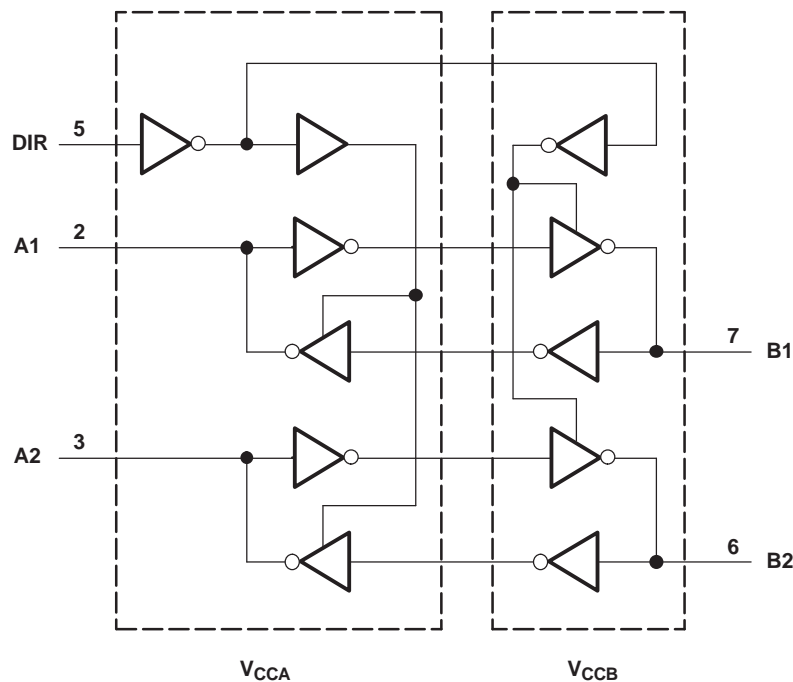

Absolute Maximum Ratings⁽¹⁾

over operating free-air temperature range (unless otherwise noted)

		MIN	MAX	UNIT	
V_{CCA} V_{CCB}	Supply voltage range	-0.5	6.5	V	
V_I	Input voltage range ⁽²⁾	-0.5	6.5	V	
V_O	Voltage range applied to any output in the high-impedance or power-off state ⁽²⁾	-0.5	6.5	V	
V_O	Voltage range applied to any output in the high or low state ⁽²⁾ (3)	A port	-0.5	$V_{CCA} + 0.5$	V
		B port	-0.5	$V_{CCB} + 0.5$	
I_{IK}	Input clamp current	$V_I < 0$	-50	mA	
I_{OK}	Output clamp current	$V_O < 0$	-50	mA	
I_O	Continuous output current		±50	mA	
	Continuous current through V_{CC} or GND		±100	mA	
θ_{JA}	Package thermal impedance ⁽⁴⁾	DCT	220	°C/W	
		DCU	329.4		
T_{stg}	Storage temperature range	-65	150	°C	

- (1) Stresses beyond those listed under "absolute maximum ratings" may cause permanent damage to the device. These are stress ratings only, and functional operation of the device at these or any other conditions beyond those indicated under "recommended operating conditions" is not implied. Exposure to absolute-maximum-rated conditions for extended periods may affect device reliability.
- (2) The input and output negative-voltage ratings may be exceeded if the input and output clamp-current ratings are observed.
- (3) The value of V_{CC} is provided in the recommended operating conditions table.
- (4) The package thermal impedance is calculated in accordance with JESD 51-7.

Recommended Operating Conditions^{(1) (2) (3)}

		V_{CCI}	V_{CCO}	MIN	MAX	UNIT
V_{CCA}	Supply voltage			1.65	5.5	V
V_{CCB}				1.65	5.5	
V_{IH}	High-level input voltage	Data inputs ⁽⁴⁾	1.65 V to 1.95 V	$V_{CCI} \times 0.65$	V	
			2.3 V to 2.7 V	1.7		
			3 V to 3.6 V	2		
			4.5 V to 5.5 V	$V_{CCI} \times 0.7$		
V_{IL}	Low-level input voltage	Data inputs ⁽⁴⁾	1.65 V to 1.95 V	$V_{CCI} \times 0.35$	V	
			2.3 V to 2.7 V	0.7		
			3 V to 3.6 V	0.8		
			4.5 V to 5.5 V	$V_{CCI} \times 0.3$		
V_{IH}	High-level input voltage	DIR (referenced to V_{CCA}) ⁽⁵⁾	1.65 V to 1.95 V	$V_{CCA} \times 0.65$	V	
			2.3 V to 2.7 V	1.7		
			3 V to 3.6 V	2		
			4.5 V to 5.5 V	$V_{CCA} \times 0.7$		
V_{IL}	Low-level input voltage	DIR (referenced to V_{CCA}) ⁽⁵⁾	1.65 V to 1.95 V	$V_{CCA} \times 0.35$	V	
			2.3 V to 2.7 V	0.7		
			3 V to 3.6 V	0.8		
			4.5 V to 5.5 V	$V_{CCA} \times 0.3$		
V_I	Input voltage			0	5.5	V
V_O	Output voltage			0	V_{CCO}	V
I_{OH}	High-level output current		1.65 V to 1.95 V	-4	mA	
			2.3 V to 2.7 V	-8		
			3 V to 3.6 V	-24		
			4.5 V to 5.5 V	-32		
I_{OL}	Low-level output current		1.65 V to 1.95 V	4	mA	
			2.3 V to 2.7 V	8		
			3 V to 3.6 V	24		
			4.5 V to 5.5 V	32		
$\Delta t/\Delta v$	Input transition rise or fall rate	Data inputs	1.65 V to 1.95 V	20	ns/V	
			2.3 V to 2.7 V	20		
			3 V to 3.6 V	10		
			4.5 V to 5.5 V	5		
		Control input	1.65 V to 5.5 V	5		
T_A	Operating free-air temperature	DCT		-55	125	°C
		DCU		-55	150	

(1) V_{CCI} is the V_{CC} associated with the input port.

(2) V_{CCO} is the V_{CC} associated with the output port.

(3) All unused data inputs of the device must be held at V_{CCI} or GND to ensure proper device operation. Refer to the TI application report, *Implications of Slow or Floating CMOS Inputs*, literature number SCBA004.

(4) For V_{CCI} values not specified in the data sheet, V_{IH} min = $V_{CCI} \times 0.7$ V, V_{IL} max = $V_{CCI} \times 0.3$ V.

(5) For V_{CCI} values not specified in the data sheet, V_{IH} min = $V_{CCA} \times 0.7$ V, V_{IL} max = $V_{CCA} \times 0.3$ V.

Electrical Characteristics^{(1) (2)}

over recommended operating free-air temperature range (unless otherwise noted)

PARAMETER	TEST CONDITIONS		V _{CCA}	V _{CCB}	T _A = 25°C		-55°C to 125°C		-55°C to 150°C		UNIT
					TYP	MAX	MIN	MAX	MIN	MAX	
V _{OH}		V _I = V _{IH}	1.65 V to 4.5 V	1.65 V to 4.5 V			V _{CCO} - 0.1		V _{CCO} - 0.1		V
			1.65 V	1.65 V			1.2		1.2		
			2.3 V	2.3 V			1.9		1.9		
			3 V	3 V			2.4		2.4		
			4.5 V	4.5 V			3.8		3.8		
V _{OL}		V _I = V _{IL}	1.65 V to 4.5 V	1.65 V to 4.5 V				0.1		0.1	V
			1.65 V	1.65 V				0.45		0.45	
			2.3 V	2.3 V				0.3		0.3	
			3 V	3 V				0.55		0.55	
			4.5 V	4.5 V				0.55		0.55	
I _I	DIR	V _I = V _{CCA} or GND	1.65 V to 5.5 V	1.65 V to 5.5 V		±1		±2		±2	μA
I _{off}	A port	V _I or V _O = 0 to 5.5 V	0 V	0 to 5.5 V		±1		±9		±9	μA
	B port		0 to 5.5 V	0 V		±1		±9		±9	
I _{OZ}	A or B port	V _O = V _{CCO} or GND	1.65 V to 5.5 V	1.65 V to 5.5 V		±1		±9		±9	μA
I _{CCA}		V _I = V _{CCI} or GND, I _O = 0	1.65 V to 5.5 V	1.65 V to 5.5 V				4		4	μA
			5 V	0 V				2		2	
			0 V	5 V				-12		-12	
I _{CCB}		V _I = V _{CCI} or GND, I _O = 0	1.65 V to 5.5 V	1.65 V to 5.5 V				4		4	μA
			5 V	0 V				-12		-12	
			0 V	5 V				2		2	
I _{CCA} + I _{CCB} (see Table 3)		V _I = V _{CCI} or GND, I _O = 0	1.65 V to 5.5 V	1.65 V to 5.5 V				4		4	μA
ΔI _{CCA}	A port	One A port at V _{CCA} - 0.6 V, DIR at V _{CCA} , B port = open	3 V to 5.5 V	3 V to 5.5 V				50		50	μA
	DIR				DIR at V _{CCA} - 0.6 V, B port = open, A port at V _{CCA} or GND				50		
ΔI _{CCB}	B port	One B port at V _{CCB} - 0.6 V, DIR at GND, A port = open	3 V to 5.5 V	3 V to 5.5 V				50		50	μA
C _I	DIR	V _I = V _{CCA} or GND	3.3 V	3.3 V		2.5					pF
C _{io}	A or B port	V _O = V _{CCA/B} or GND	3.3 V	3.3 V		6					pF

 (1) V_{CCO} is the V_{CC} associated with the output port.

 (2) V_{CCI} is the V_{CC} associated with the input port.

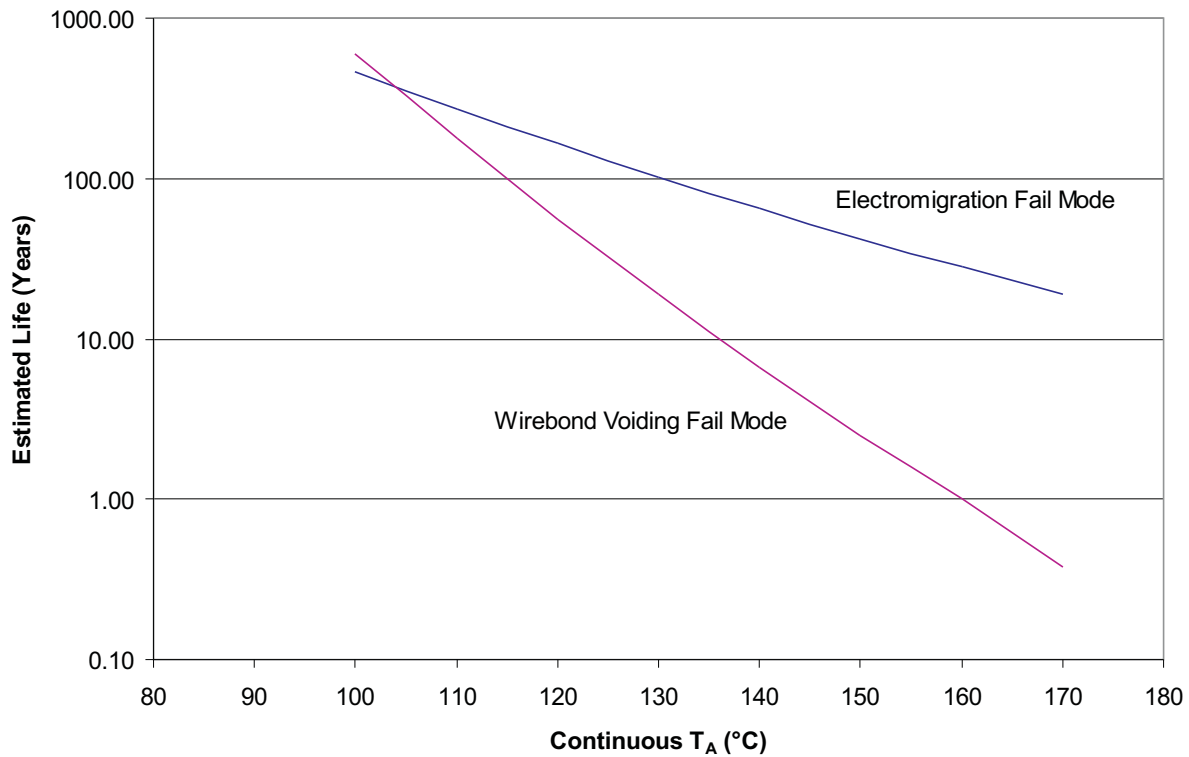
**Notes:**

1. See datasheet for absolute maximum and minimum recommended operating conditions.
2. Silicon operating life design goal is 10 years at 105°C junction temperature (does not include package interconnect life).
3. Product disclaimer applies to DCU package 150°C.

Figure 1. LVC2T45SDCU Operating Life Derating Chart

Switching Characteristics

over recommended operating free-air temperature range, $V_{CCA} = 1.8\text{ V} \pm 0.15\text{ V}$ (unless otherwise noted) (see [Figure 2](#))

PARAMETER	FROM (INPUT)	TO (OUTPUT)	$V_{CCB} = 1.8\text{ V} \pm 0.15\text{ V}$		$V_{CCB} = 2.5\text{ V} \pm 0.2\text{ V}$		$V_{CCB} = 3.3\text{ V} \pm 0.3\text{ V}$		$V_{CCB} = 5\text{ V} \pm 0.5\text{ V}$		UNIT
			MIN	MAX	MIN	MAX	MIN	MAX	MIN	MAX	
t_{PLH}	A	B	3	21.7	2.2	14.3	1.7	12.3	1.4	11.2	ns
t_{PHL}			2.8	28.3	2.2	12.5	1.8	11.1	1.7	11	
t_{PLH}	B	A	3	21.7	2.3	20	2.1	19.5	1.9	19.1	ns
t_{PHL}			2.8	18.3	2.1	16.9	2	16.6	1.8	16.2	
t_{PHZ}	DIR	A	10.6	34.9	10.3	34.5	10.5	34.5	10.7	33.3	ns
t_{PLZ}			7.3	23.7	7.5	23.6	7.5	23.5	7	23.4	
t_{PHZ}	DIR	B	10	31.9	8.4	18.9	6.5	15.3	4.1	12.6	ns
t_{PLZ}			6.5	23.5	7.2	16.6	4.3	13.7	2.1	11.1	
$t_{PZH}^{(1)}$	DIR	A		45.2		36.6		33.2		30.2	ns
$t_{PZL}^{(1)}$				50.2		35.8		31.9		28.8	
$t_{PZH}^{(1)}$	DIR	B		45.4		37.9		35.8		34.6	ns
$t_{PZL}^{(1)}$				53.2		47		45.6		44.3	

(1) The enable time is a calculated value, derived using the formula shown in the *enable times* section.

Switching Characteristics

over recommended operating free-air temperature range, $V_{CCA} = 2.5\text{ V} \pm 0.2\text{ V}$ (unless otherwise noted) (see [Figure 2](#))

PARAMETER	FROM (INPUT)	TO (OUTPUT)	$V_{CCB} = 1.8\text{ V} \pm 0.15\text{ V}$		$V_{CCB} = 2.5\text{ V} \pm 0.2\text{ V}$		$V_{CCB} = 3.3\text{ V} \pm 0.3\text{ V}$		$V_{CCB} = 5\text{ V} \pm 0.5\text{ V}$		UNIT
			MIN	MAX	MIN	MAX	MIN	MAX	MIN	MAX	
t_{PLH}	A	B	2.3	20	1.5	12.5	1.3	10.4	1.1	9.1	ns
t_{PHL}			2.1	16.9	1.4	11.5	1.3	9.4	0.9	8.6	
t_{PLH}	B	A	2.2	14.3	1.5	12.5	1.4	12	1	11.5	ns
t_{PHL}			2.2	12.5	1.4	11.5	1.3	11	0.9	10.2	
t_{PHZ}	DIR	A	6.6	21.1	7.1	20.8	6.8	20.8	5.2	20.5	ns
t_{PLZ}			5.3	16.6	5.2	16.5	4.9	16.3	4.8	16.3	
t_{PHZ}	DIR	B	10.7	31.9	8.1	17.9	5.8	14.5	3.5	11.6	ns
t_{PLZ}			7.8	22.9	6.2	15.2	3.6	12.9	1.4	11.2	
$t_{PZH}^{(1)}$	DIR	A		37.2		27.7		24.9		21.7	ns
$t_{PZL}^{(1)}$				44.4		29.4		25.5		21.8	
$t_{PZH}^{(1)}$	DIR	B		26.6		29		26.7		25.4	ns
$t_{PZL}^{(1)}$				38		32.3		30.2		29.1	

(1) The enable time is a calculated value, derived using the formula shown in the *enable times* section.

Switching Characteristics

over recommended operating free-air temperature range, $V_{CCA} = 3.3 \text{ V} \pm 0.3 \text{ V}$ (unless otherwise noted) (see Figure 2)

PARAMETER	FROM (INPUT)	TO (OUTPUT)	$V_{CCB} = 1.8 \text{ V} \pm 0.15 \text{ V}$		$V_{CCB} = 2.5 \text{ V} \pm 0.2 \text{ V}$		$V_{CCB} = 3.3 \text{ V} \pm 0.3 \text{ V}$		$V_{CCB} = 5 \text{ V} \pm 0.5 \text{ V}$		UNIT
			MIN	MAX	MIN	MAX	MIN	MAX	MIN	MAX	
t_{PLH}	A	B	2.1	19.5	1.4	12	0.7	9.6	0.7	8.4	ns
t_{PHL}			2	16.6	1.3	11	0.8	9	0.7	8	
t_{PLH}	B	A	1.7	12.3	1.3	10.4	0.7	9.8	0.6	9.4	ns
t_{PHL}			1.8	11.1	1.3	9.4	0.8	9	0.7	8.5	
t_{PHZ}	DIR	A	5	14.9	5.1	14.8	5	14.8	5	14.4	ns
t_{PLZ}			3.4	12.4	3.7	12.4	3.9	12.1	3.3	11.8	
t_{PHZ}	DIR	B	11.2	31.3	8	17.7	5.8	14.4	2.9	11.4	ns
t_{PLZ}			9.4	21.7	5.6	15.3	4.3	12.3	1	9.6	
$t_{PZH}^{(1)}$	DIR	A	34		25.7		22.1		19		ns
$t_{PZL}^{(1)}$			42.4		27.1		23.4		19.9		
$t_{PZH}^{(1)}$	DIR	B	31.9		24.4		21.9		20.2		ns
$t_{PZL}^{(1)}$			31.5		25.8		23.8		22.4		

(1) The enable time is a calculated value, derived using the formula shown in the *enable times* section.

Switching Characteristics

over recommended operating free-air temperature range, $V_{CCA} = 5 \text{ V} \pm 0.5 \text{ V}$ (unless otherwise noted) (see Figure 2)

PARAMETER	FROM (INPUT)	TO (OUTPUT)	$V_{CCB} = 1.8 \text{ V} \pm 0.15 \text{ V}$		$V_{CCB} = 2.5 \text{ V} \pm 0.2 \text{ V}$		$V_{CCB} = 3.3 \text{ V} \pm 0.3 \text{ V}$		$V_{CCB} = 5 \text{ V} \pm 0.5 \text{ V}$		UNIT
			MIN	MAX	MIN	MAX	MIN	MAX	MIN	MAX	
t_{PLH}	A	B	1.9	19.1	1	11.5	0.6	9.4	0.5	7.9	ns
t_{PHL}			1.8	16.2	0.9	10.2	0.7	8.5	0.5	7.5	
t_{PLH}	B	A	1.4	11.2	1	9.1	0.7	8.4	0.5	7.9	ns
t_{PHL}			1.7	11	0.9	8.6	0.7	8	0.5	7.5	
t_{PHZ}	DIR	A	2.9	12.2	2.9	11.9	2.8	11.9	2.2	11.8	ns
t_{PLZ}			1.4	10.9	1.3	10.7	0.7	10.7	0.7	10.6	
t_{PHZ}	DIR	B	11.2	30.1	7.2	17.9	5.8	14.1	1.3	11.3	ns
t_{PLZ}			8.4	20.9	5	15	4	11.7	1	9.6	
$t_{PZH}^{(1)}$	DIR	A	32.1		24.1		20.1		18.5		ns
$t_{PZL}^{(1)}$			41.1		26.5		22.1		18.8		
$t_{PZH}^{(1)}$	DIR	B	30		22.2		20.1		18.5		ns
$t_{PZL}^{(1)}$			28.4		22.1		22.4		19.3		

(1) The enable time is a calculated value, derived using the formula shown in the *enable times* section.

Operating Characteristics

 $T_A = 25^\circ\text{C}$

PARAMETER		TEST CONDITIONS	$V_{CCA} =$ $V_{CCB} = 1.8\text{ V}$	$V_{CCA} =$ $V_{CCB} = 2.5\text{ V}$	$V_{CCA} =$ $V_{CCB} = 3.3\text{ V}$	$V_{CCA} =$ $V_{CCB} = 5\text{ V}$	UNIT
			TYP	TYP	TYP	TYP	
C_{pdA} (1)	A-port input, B-port output	$C_L = 0\text{ pF},$ $f = 10\text{ MHz},$ $t_r = t_f = 1\text{ ns}$	3	4	4	4	pF
	B-port input, A-port output		18	19	20	21	
C_{pdB} (1)	A-port input, B-port output	$C_L = 0\text{ pF},$ $f = 10\text{ MHz},$ $t_r = t_f = 1\text{ ns}$	18	19	20	21	pF
	B-port input, A-port output		3	4	4	4	

(1) Power dissipation capacitance per transceiver

Power-Up Considerations

A proper power-up sequence always should be followed to avoid excessive supply current, bus contention, oscillations, or other anomalies. To guard against such power-up problems, take the following precautions:

1. Connect ground before any supply voltage is applied.
2. Power up V_{CCA} .
3. V_{CCB} can be ramped up along with or after V_{CCA} .

Table 3. Typical Total Static Power Consumption ($I_{CCA} + I_{CCB}$)

V_{CCB}	V_{CCA}					UNIT
	0 V	1.8 V	2.5 V	3.3 V	5 V	
0 V	0	<1	<1	<1	<1	μA
1.8 V	<1	<2	<2	<2	2	
2.5 V	<1	<2	<2	<2	<2	
3.3 V	<1	<2	<2	<2	<2	
5 V	<1	2	<2	<2	<2	

TYPICAL CHARACTERISTICS

TYPICAL PROPAGATION DELAY (A to B) vs LOAD CAPACITANCE

$T_A = 25^\circ\text{C}$, $V_{CCA} = 1.8\text{ V}$

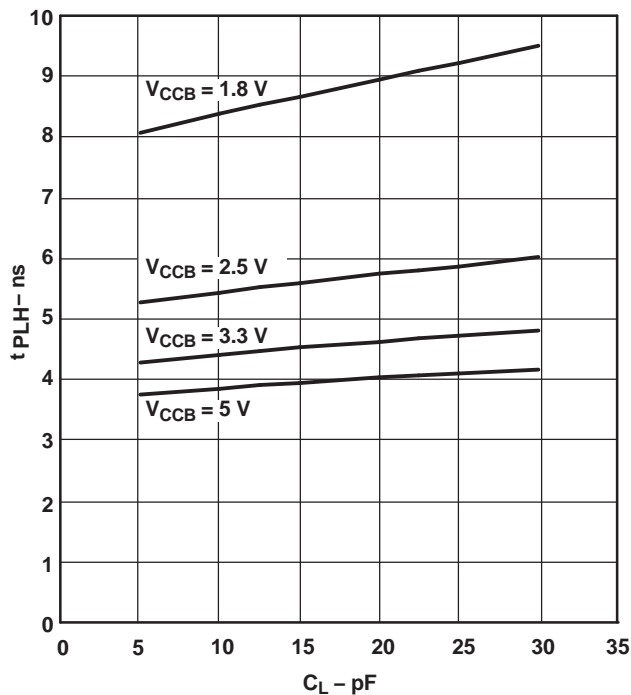
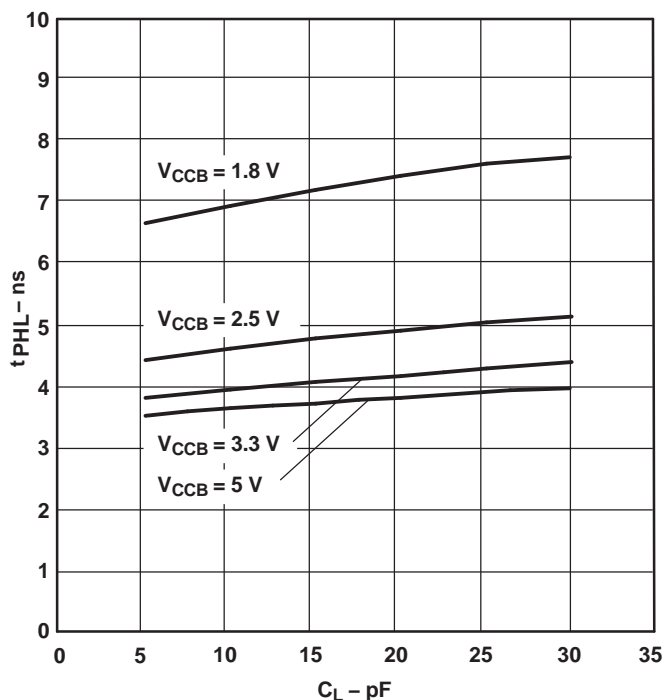

TYPICAL PROPAGATION DELAY (B to A) vs LOAD CAPACITANCE
 $T_A = 25^\circ\text{C}, V_{CCA} = 1.8\text{ V}$

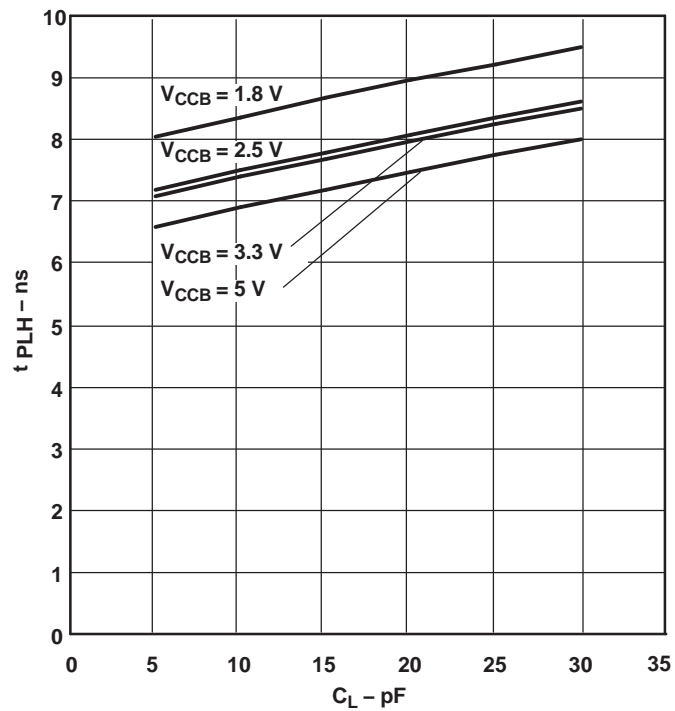
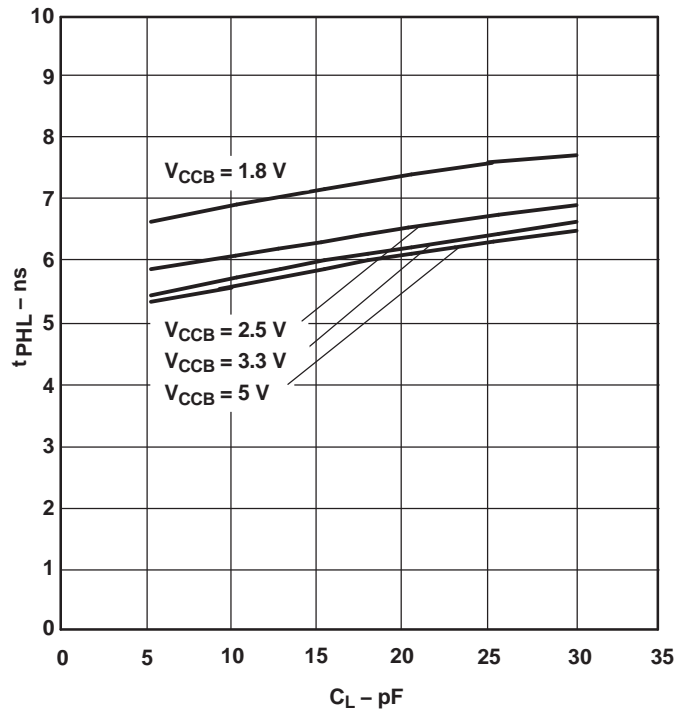

TYPICAL PROPAGATION DELAY (A to B) vs LOAD CAPACITANCE
 $T_A = 25^\circ\text{C}$, $V_{CCA} = 2.5\text{ V}$

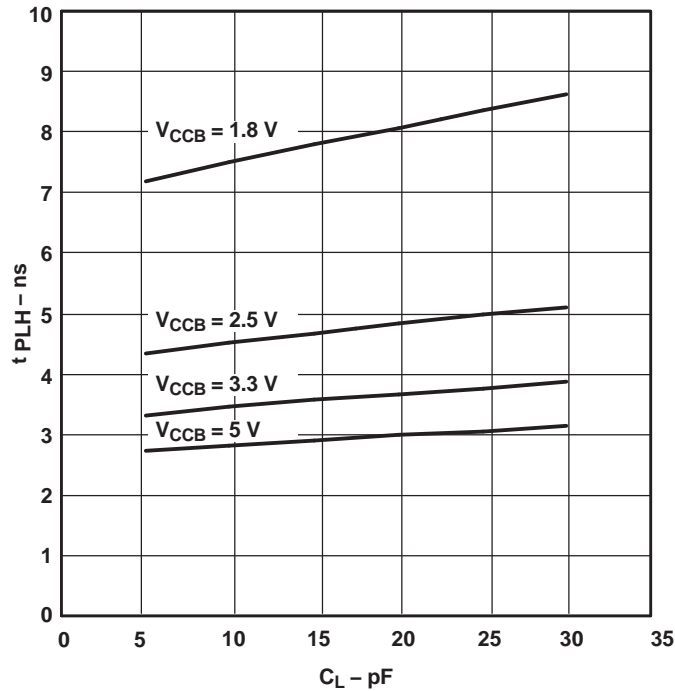
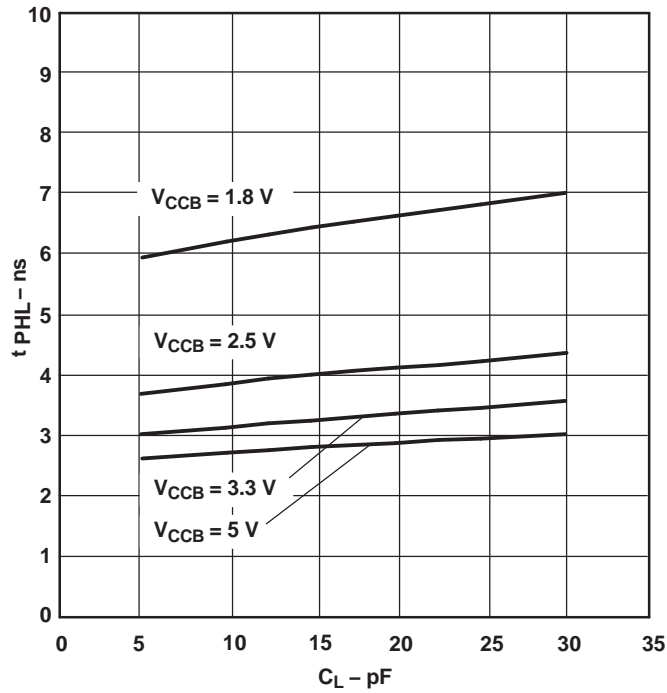

TYPICAL PROPAGATION DELAY (B to A) vs LOAD CAPACITANCE
 $T_A = 25^\circ\text{C}, V_{CCA} = 2.5\text{ V}$

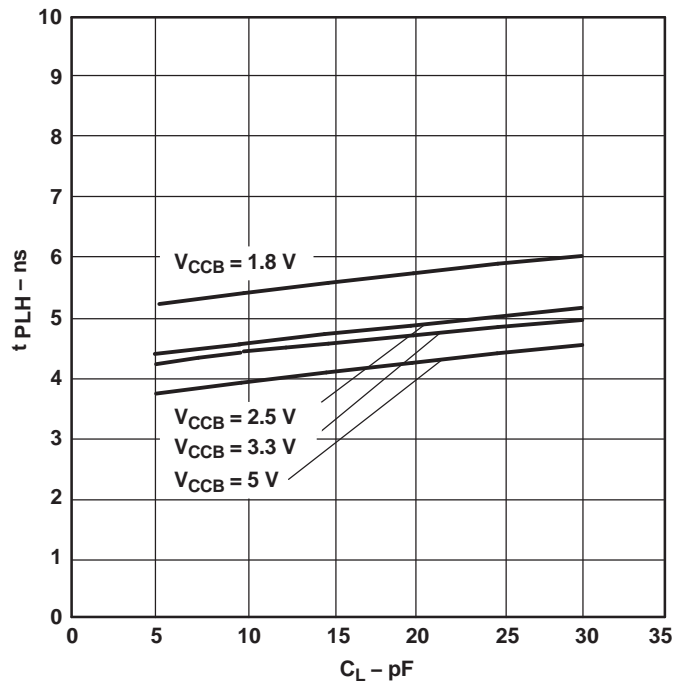
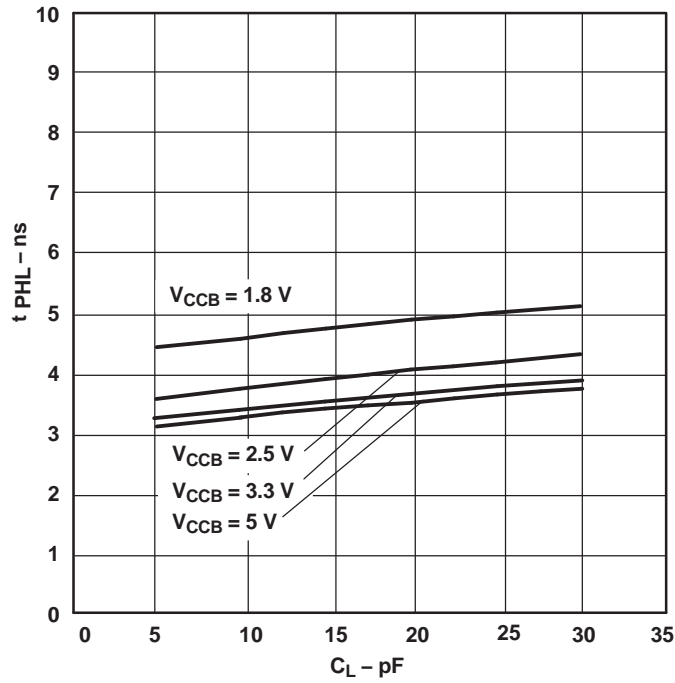

TYPICAL PROPAGATION DELAY (A to B) vs LOAD CAPACITANCE
 $T_A = 25^\circ\text{C}$, $V_{CCA} = 3.3\text{ V}$

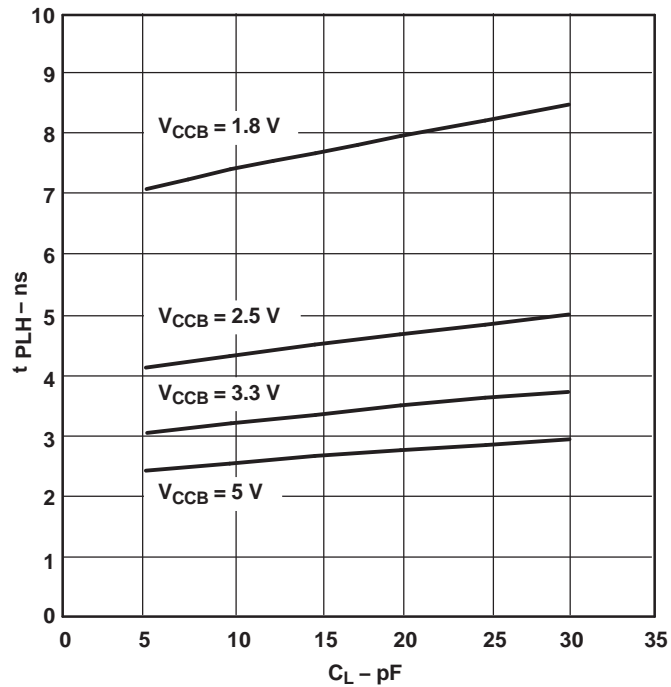
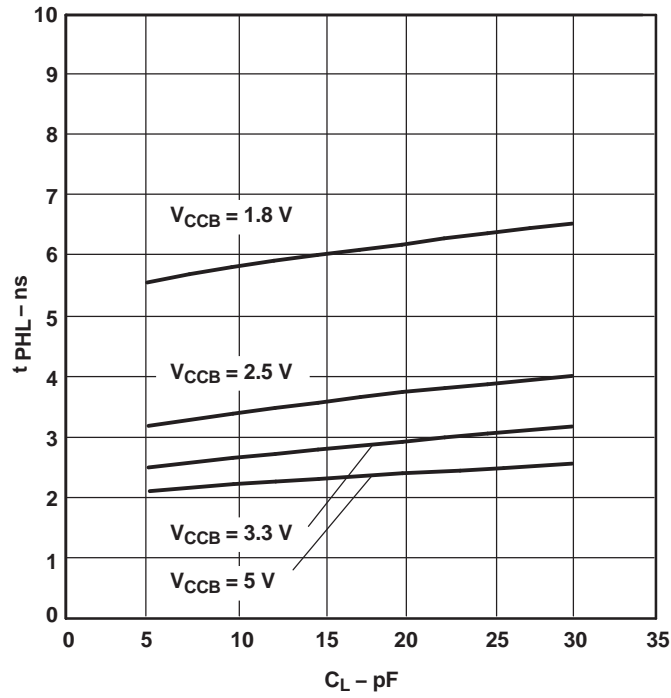

TYPICAL PROPAGATION DELAY (B to A) vs LOAD CAPACITANCE
 $T_A = 25^\circ\text{C}, V_{CCA} = 3.3\text{ V}$

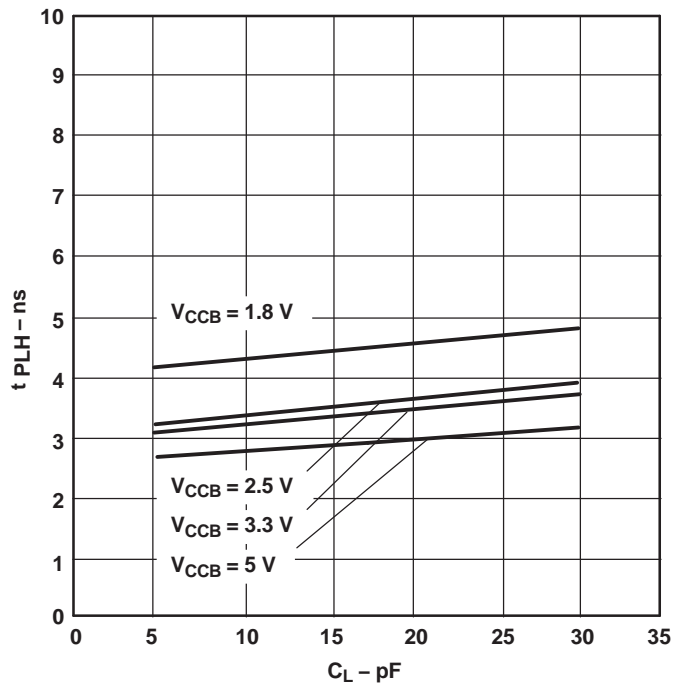
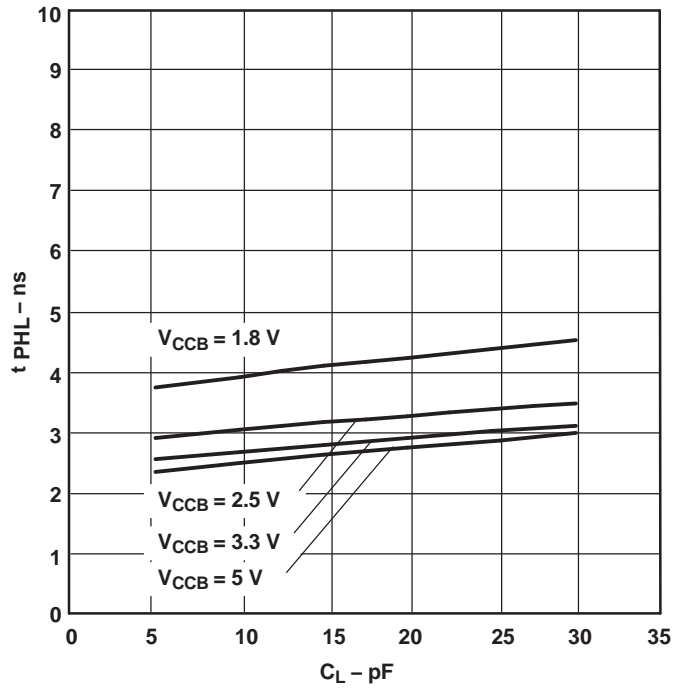

TYPICAL PROPAGATION DELAY (A to B) vs LOAD CAPACITANCE
 $T_A = 25^\circ\text{C}$, $V_{CCA} = 5\text{ V}$

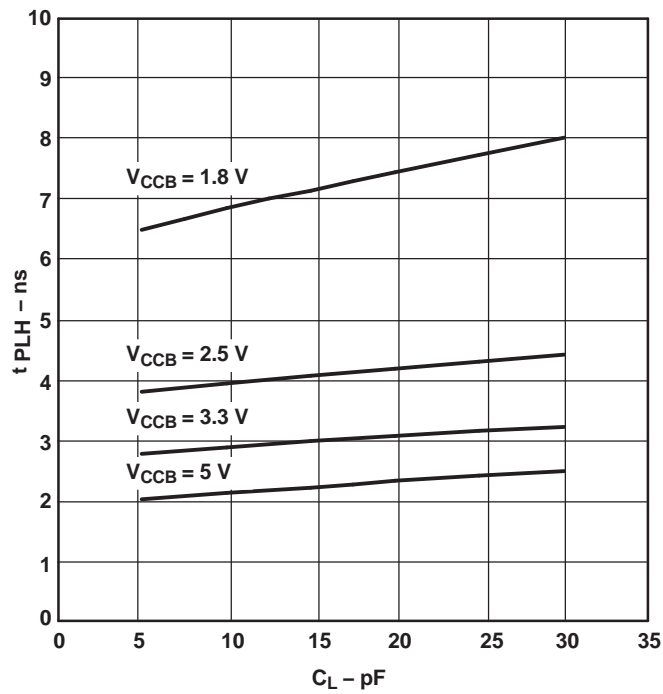
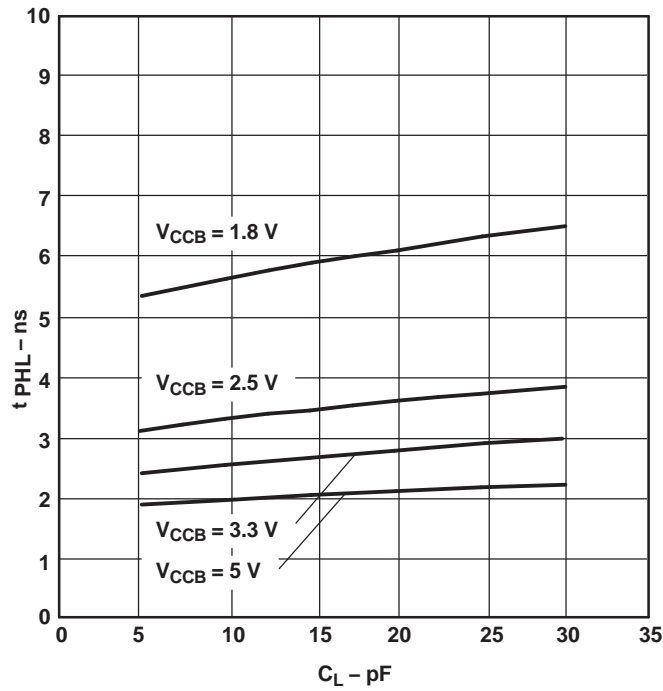

TYPICAL PROPAGATION DELAY (B to A) vs LOAD CAPACITANCE
 $T_A = 25^\circ\text{C}, V_{CCA} = 5\text{ V}$

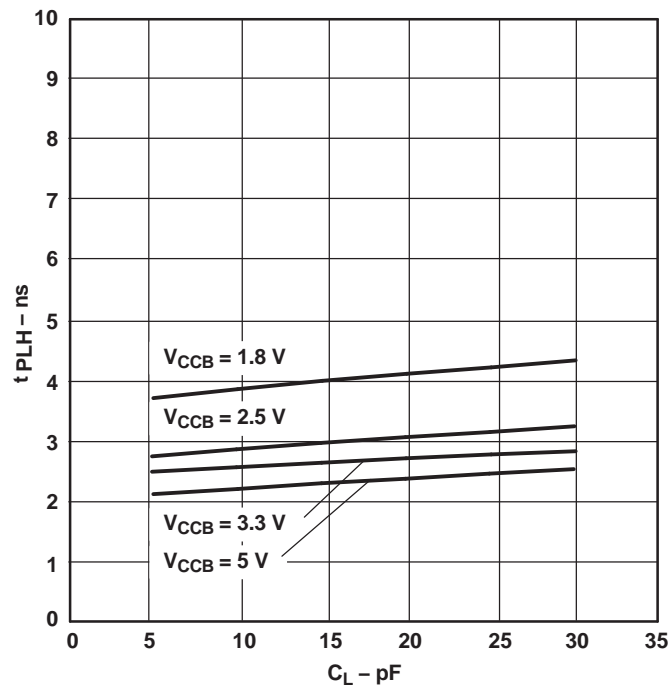
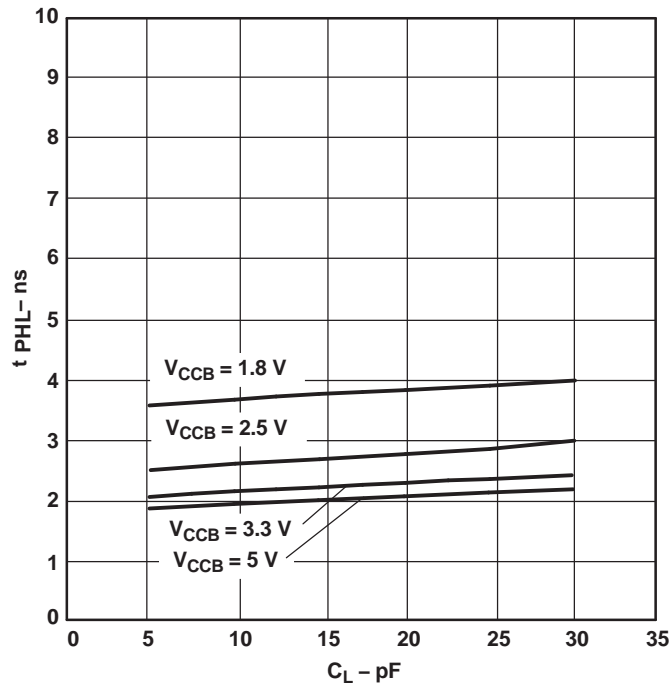

PARAMETER MEASUREMENT INFORMATION

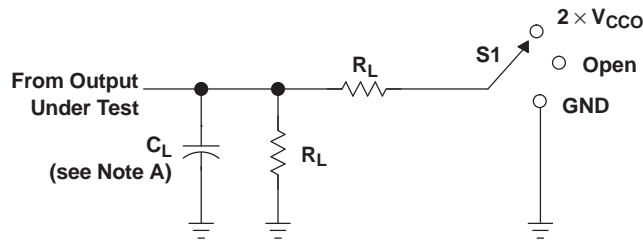

LOAD CIRCUIT

TEST	S1
t_{pd}	Open
t_{PLZ}/t_{PZL}	$2 \times V_{CCO}$
t_{PHZ}/t_{PZH}	GND

V_{CCO}	C_L	R_L	V_{TP}
$1.8\text{ V} \pm 0.15\text{ V}$	15 pF	2 k Ω	0.15 V
$2.5\text{ V} \pm 0.2\text{ V}$	15 pF	2 k Ω	0.15 V
$3.3\text{ V} \pm 0.3\text{ V}$	15 pF	2 k Ω	0.3 V
$5\text{ V} \pm 0.5\text{ V}$	15 pF	2 k Ω	0.3 V

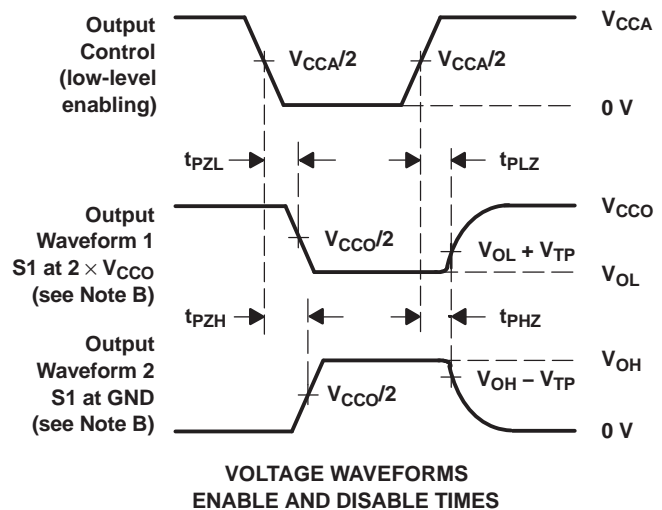
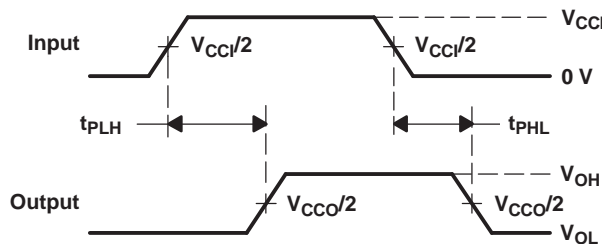
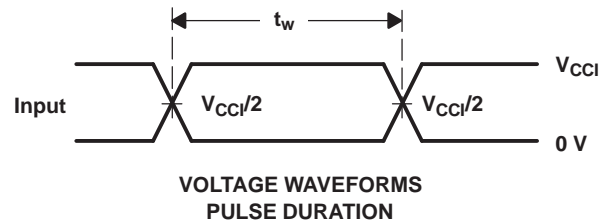

- NOTES:
- A. C_L includes probe and jig capacitance.
 - B. Waveform 1 is for an output with internal conditions such that the output is low, except when disabled by the output control. Waveform 2 is for an output with internal conditions such that the output is high, except when disabled by the output control.
 - C. All input pulses are supplied by generators having the following characteristics: PRR \leq 10 MHz, $Z_O = 50\ \Omega$, $dv/dt \geq 1\text{ V/ns}$.
 - D. The outputs are measured one at a time, with one transition per measurement.
 - E. t_{PLZ} and t_{PHZ} are the same as t_{dis} .
 - F. t_{PZL} and t_{PZH} are the same as t_{en} .
 - G. t_{PLH} and t_{PHL} are the same as t_{pd} .
 - H. V_{CC1} is the V_{CC} associated with the input port.
 - I. V_{CCO} is the V_{CC} associated with the output port.
 - J. All parameters and waveforms are not applicable to all devices.

Figure 2. Load Circuit and Voltage Waveforms

APPLICATION INFORMATION

The following shows an example of the SN74LVC2T45 being used in a unidirectional logic level-shifting application.

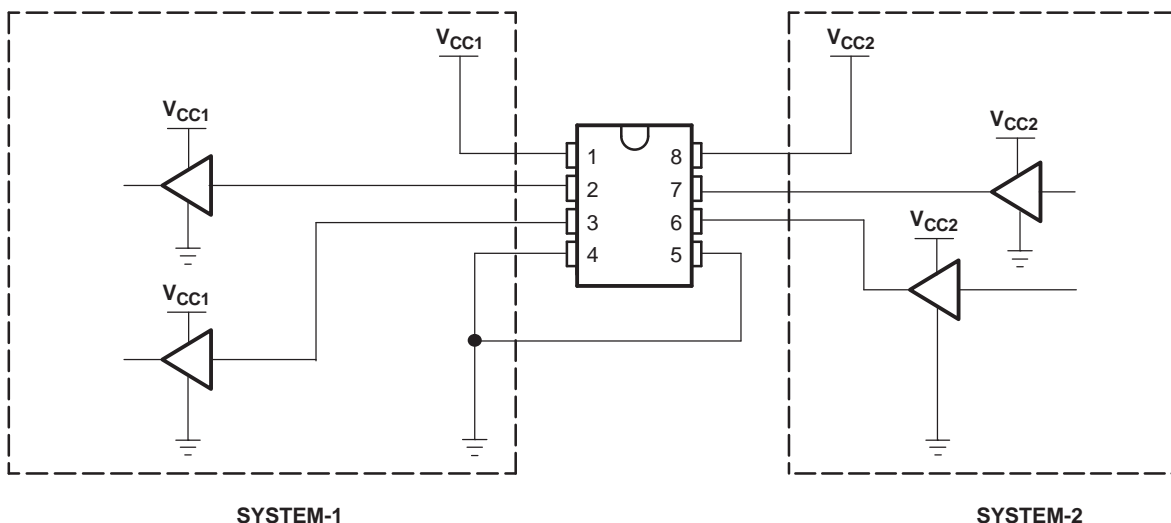

PIN	NAME	FUNCTION	DESCRIPTION
1	V _{CCA}	V _{CC1}	SYSTEM-1 supply voltage (1.65 V to 5.5 V)
2	A1	OUT1	Output level depends on V _{CC1} voltage.
3	A2	OUT2	Output level depends on V _{CC1} voltage.
4	GND	GND	Device GND
5	DIR	DIR	GND (low level) determines B-port to A-port direction.
6	B2	IN2	Input threshold value depends on V _{CC2} voltage.
7	B1	IN1	Input threshold value depends on V _{CC2} voltage.
8	V _{CCB}	V _{CC2}	SYSTEM-2 supply voltage (1.65 V to 5.5 V)

Figure 3. Unidirectional Logic Level-Shifting Application

APPLICATION INFORMATION

Figure 4 shows the SN74LVC2T45 being used in a bidirectional logic level-shifting application. Since the SN74LVC2T45 does not have an output-enable (OE) pin, the system designer should take precautions to avoid bus contention between SYSTEM-1 and SYSTEM-2 when changing directions.

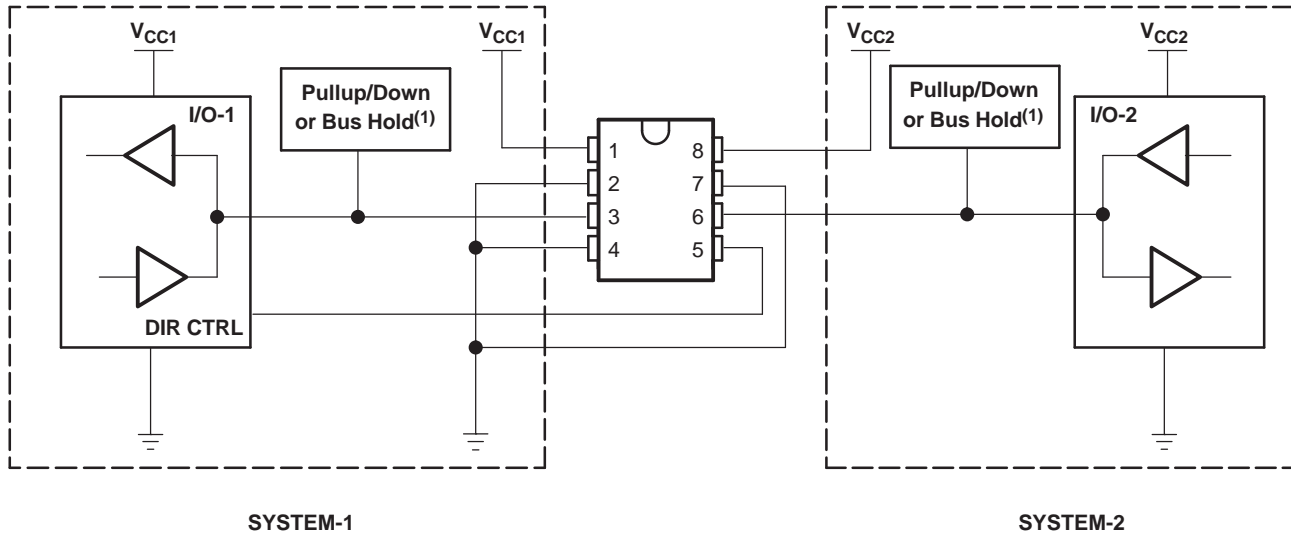

The following table shows data transmission from SYSTEM-1 to SYSTEM-2 and then from SYSTEM-2 to SYSTEM-1.

STATE	DIR CTRL	I/O-1	I/O-2	DESCRIPTION
1	H	Out	In	SYSTEM-1 data to SYSTEM-2
2	H	Hi-Z	Hi-Z	SYSTEM-2 is getting ready to send data to SYSTEM-1. I/O-1 and I/O-2 are disabled. The bus-line state depends on pullup or pulldown. ⁽¹⁾
3	L	Hi-Z	Hi-Z	DIR bit is flipped. I/O-1 and I/O-2 still are disabled. The bus-line state depends on pullup or pulldown. ⁽¹⁾
4	L	In	Out	SYSTEM-2 data to SYSTEM-1

(1) SYSTEM-1 and SYSTEM-2 must use the same conditions, i.e., both pullup or both pulldown.

Figure 4. Bidirectional Logic Level-Shifting Application

Enable Times

Calculate the enable times for the SN74LVC2T45 using the following formulas:

- $t_{PZH} \text{ (DIR to A)} = t_{PLZ} \text{ (DIR to B)} + t_{PLH} \text{ (B to A)}$
- $t_{PZL} \text{ (DIR to A)} = t_{PHZ} \text{ (DIR to B)} + t_{PHL} \text{ (B to A)}$
- $t_{PZH} \text{ (DIR to B)} = t_{PLZ} \text{ (DIR to A)} + t_{PLH} \text{ (A to B)}$
- $t_{PZL} \text{ (DIR to B)} = t_{PHZ} \text{ (DIR to A)} + t_{PHL} \text{ (A to B)}$

In a bidirectional application, these enable times provide the maximum delay from the time the DIR bit is switched until an output is expected. For example, if the SN74LVC2T45 initially is transmitting from A to B, then the DIR bit is switched; the B port of the device must be disabled before presenting it with an input. After the B port has been disabled, an input signal applied to it appears on the corresponding A port after the specified propagation delay.

PACKAGING INFORMATION

Orderable part number	Status (1)	Material type (2)	Package Pins	Package qty Carrier	RoHS (3)	Lead finish/ Ball material (4)	MSL rating/ Peak reflow (5)	Op temp (°C)	Part marking (6)
SN74LVC2T45MDCTTEP	Active	Production	SSOP (DCT) 8	250 SMALL T&R	Yes	NIPDAU	Level-1-260C-UNLIM	-55 to 125	NXR Z
V62/09604-01XE	Active	Production	SSOP (DCT) 8	250 SMALL T&R	Yes	NIPDAU	Level-1-260C-UNLIM	-55 to 125	NXR Z

(1) **Status:** For more details on status, see our [product life cycle](#).

(2) **Material type:** When designated, preproduction parts are prototypes/experimental devices, and are not yet approved or released for full production. Testing and final process, including without limitation quality assurance, reliability performance testing, and/or process qualification, may not yet be complete, and this item is subject to further changes or possible discontinuation. If available for ordering, purchases will be subject to an additional waiver at checkout, and are intended for early internal evaluation purposes only. These items are sold without warranties of any kind.

(3) **RoHS values:** Yes, No, RoHS Exempt. See the [TI RoHS Statement](#) for additional information and value definition.

(4) **Lead finish/Ball material:** Parts may have multiple material finish options. Finish options are separated by a vertical ruled line. Lead finish/Ball material values may wrap to two lines if the finish value exceeds the maximum column width.

(5) **MSL rating/Peak reflow:** The moisture sensitivity level ratings and peak solder (reflow) temperatures. In the event that a part has multiple moisture sensitivity ratings, only the lowest level per JEDEC standards is shown. Refer to the shipping label for the actual reflow temperature that will be used to mount the part to the printed circuit board.

(6) **Part marking:** There may be an additional marking, which relates to the logo, the lot trace code information, or the environmental category of the part.

Multiple part markings will be inside parentheses. Only one part marking contained in parentheses and separated by a "-" will appear on a part. If a line is indented then it is a continuation of the previous line and the two combined represent the entire part marking for that device.

Important Information and Disclaimer: The information provided on this page represents TI's knowledge and belief as of the date that it is provided. TI bases its knowledge and belief on information provided by third parties, and makes no representation or warranty as to the accuracy of such information. Efforts are underway to better integrate information from third parties. TI has taken and continues to take reasonable steps to provide representative and accurate information but may not have conducted destructive testing or chemical analysis on incoming materials and chemicals. TI and TI suppliers consider certain information to be proprietary, and thus CAS numbers and other limited information may not be available for release.

In no event shall TI's liability arising out of such information exceed the total purchase price of the TI part(s) at issue in this document sold by TI to Customer on an annual basis.

OTHER QUALIFIED VERSIONS OF SN74LVC2T45-EP :

- Catalog : [SN74LVC2T45](#)
- Automotive : [SN74LVC2T45-Q1](#)

NOTE: Qualified Version Definitions:

- Catalog - TI's standard catalog product
- Automotive - Q100 devices qualified for high-reliability automotive applications targeting zero defects

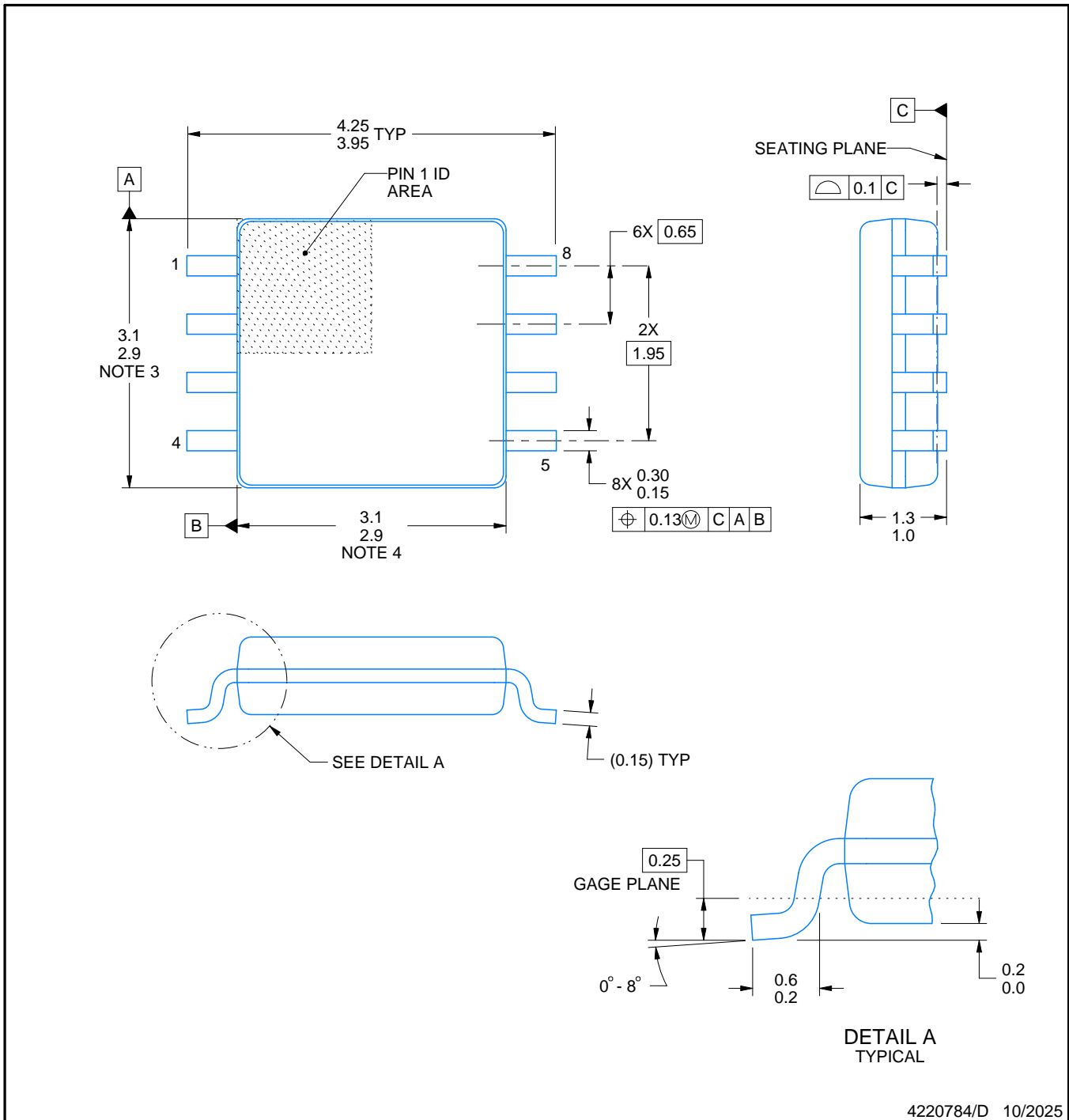
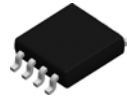

4220784/D 10/2025

NOTES:

1. All linear dimensions are in millimeters. Dimensions in parenthesis are for reference only. Dimensioning and tolerancing per ASME Y14.5M.
2. This drawing is subject to change without notice.
3. This dimension does not include mold flash, protrusions, or gate burrs. Mold flash, protrusions, or gate burrs shall not exceed 0.15 mm per side.
4. This dimension does not include interlead flash. Interlead flash shall not exceed 0.25 mm per side.

EXAMPLE BOARD LAYOUT

DCT0008A

SSOP - 1.3 mm max height

SMALL OUTLINE PACKAGE



LAND PATTERN EXAMPLE
EXPOSED METAL SHOWN
SCALE:15X

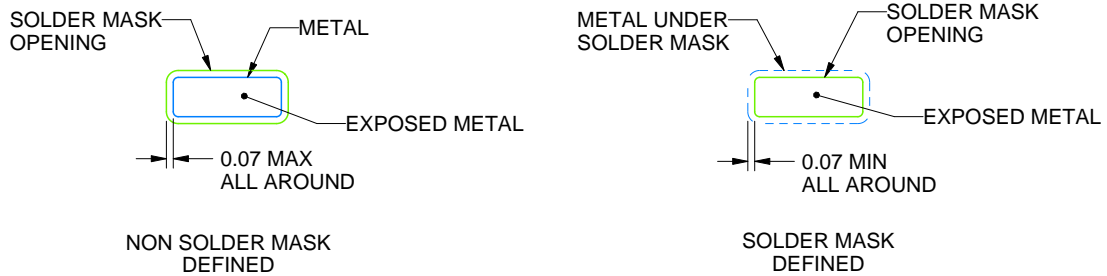

SOLDER MASK DETAILS

4220784/D 10/2025

NOTES: (continued)

- 5. Publication IPC-7351 may have alternate designs.
- 6. Solder mask tolerances between and around signal pads can vary based on board fabrication site.

EXAMPLE STENCIL DESIGN

DCT0008A

SSOP - 1.3 mm max height

SMALL OUTLINE PACKAGE

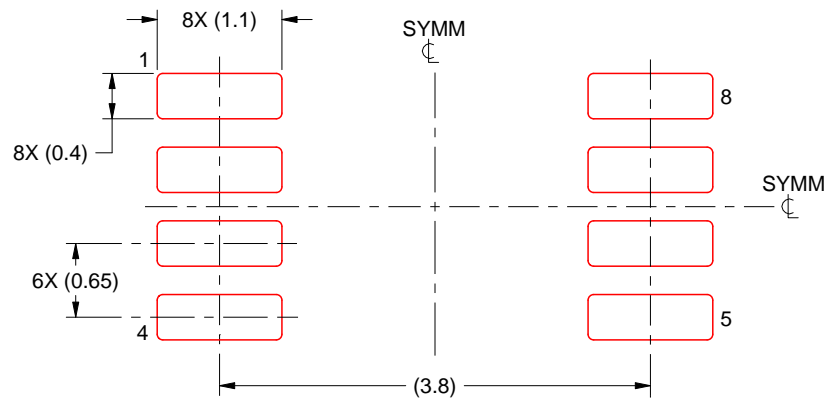

SOLDER PASTE EXAMPLE
BASED ON 0.125 mm THICK STENCIL
SCALE:15X

4220784/D 10/2025

NOTES: (continued)

7. Laser cutting apertures with trapezoidal walls and rounded corners may offer better paste release. IPC-7525 may have alternate design recommendations.
8. Board assembly site may have different recommendations for stencil design.

IMPORTANT NOTICE AND DISCLAIMER

TI PROVIDES TECHNICAL AND RELIABILITY DATA (INCLUDING DATASHEETS), DESIGN RESOURCES (INCLUDING REFERENCE DESIGNS), APPLICATION OR OTHER DESIGN ADVICE, WEB TOOLS, SAFETY INFORMATION, AND OTHER RESOURCES "AS IS" AND WITH ALL FAULTS, AND DISCLAIMS ALL WARRANTIES, EXPRESS AND IMPLIED, INCLUDING WITHOUT LIMITATION ANY IMPLIED WARRANTIES OF MERCHANTABILITY, FITNESS FOR A PARTICULAR PURPOSE OR NON-INFRINGEMENT OF THIRD PARTY INTELLECTUAL PROPERTY RIGHTS.

These resources are intended for skilled developers designing with TI products. You are solely responsible for (1) selecting the appropriate TI products for your application, (2) designing, validating and testing your application, and (3) ensuring your application meets applicable standards, and any other safety, security, regulatory or other requirements.

These resources are subject to change without notice. TI grants you permission to use these resources only for development of an application that uses the TI products described in the resource. Other reproduction and display of these resources is prohibited. No license is granted to any other TI intellectual property right or to any third party intellectual property right. TI disclaims responsibility for, and you fully indemnify TI and its representatives against any claims, damages, costs, losses, and liabilities arising out of your use of these resources.

TI's products are provided subject to [TI's Terms of Sale](#), [TI's General Quality Guidelines](#), or other applicable terms available either on ti.com or provided in conjunction with such TI products. TI's provision of these resources does not expand or otherwise alter TI's applicable warranties or warranty disclaimers for TI products. Unless TI explicitly designates a product as custom or customer-specified, TI products are standard, catalog, general purpose devices.

TI objects to and rejects any additional or different terms you may propose.

Copyright © 2026, Texas Instruments Incorporated

Last updated 10/2025