

- Replacements for ADI, PMI and LTC OP27 Series

**Features of OP27A and OP27C:**

- **Maximum Equivalent Input Noise Voltage:**  
 3.8 nV/√Hz at 1 kHz  
 5.5 nV/√Hz at 10 kHz
- **Very Low Peak-to-Peak Noise Voltage at 0.1 Hz to 10 Hz . . . 80 nV Typ**
- **Low Input Offset Voltage**  
 OP27A . . . 25 μV Max  
 OP27C . . . 100 μV Max
- **High Voltage Amplification**  
 OP27A . . . 1 V/μV Min  
 OP27C . . . 0.7 V/μV Min

**description**

The OP27 operational amplifiers combine outstanding noise performance with excellent precision and high-speed specifications. The wideband noise is only 3 nV/√Hz and with the 1/f noise corner at 2.7 Hz, low noise is maintained for all low-frequency applications.

The outstanding characteristics of the OP27 make these devices excellent choices for low-noise amplifier applications requiring precision performance and reliability.

The OP27 series is compensated for unity gain.

The OP27A and OP27C are characterized for operation over the full military temperature range of -55°C to 125°C.

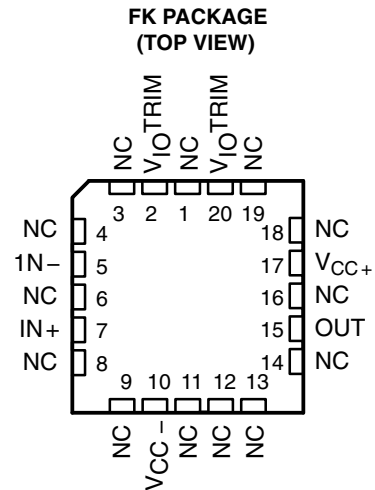
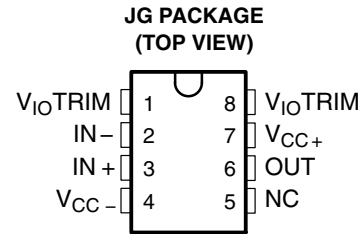

NC – No internal connection

**symbol**

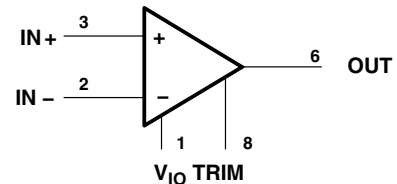

Pin numbers are for the JG packages.

**AVAILABLE OPTIONS**

T <sub>A</sub>	V <sub>IO</sub> max AT 25°C	STABLE GAIN	PACKAGE	
			CERAMIC DIP (JG)	CHIP CARRIER (FK)
-55°C to 125°C	25 μV	1	OP27AJG	OP27AFK
	100 μV	1	OP27CJG	—



Please be aware that an important notice concerning availability, standard warranty, and use in critical applications of Texas Instruments semiconductor products and disclaimers thereto appears at the end of this data sheet.

PRODUCTION DATA information is current as of publication date. Products conform to specifications per the terms of Texas Instruments standard warranty. Production processing does not necessarily include testing of all parameters.

# OP27A, OP27C LOW-NOISE HIGH-SPEED PRECISION OPERATIONAL-AMPLIFIER

SLOS100E - FEBRUARY 1989 - REVISED FEBRUARY 2010

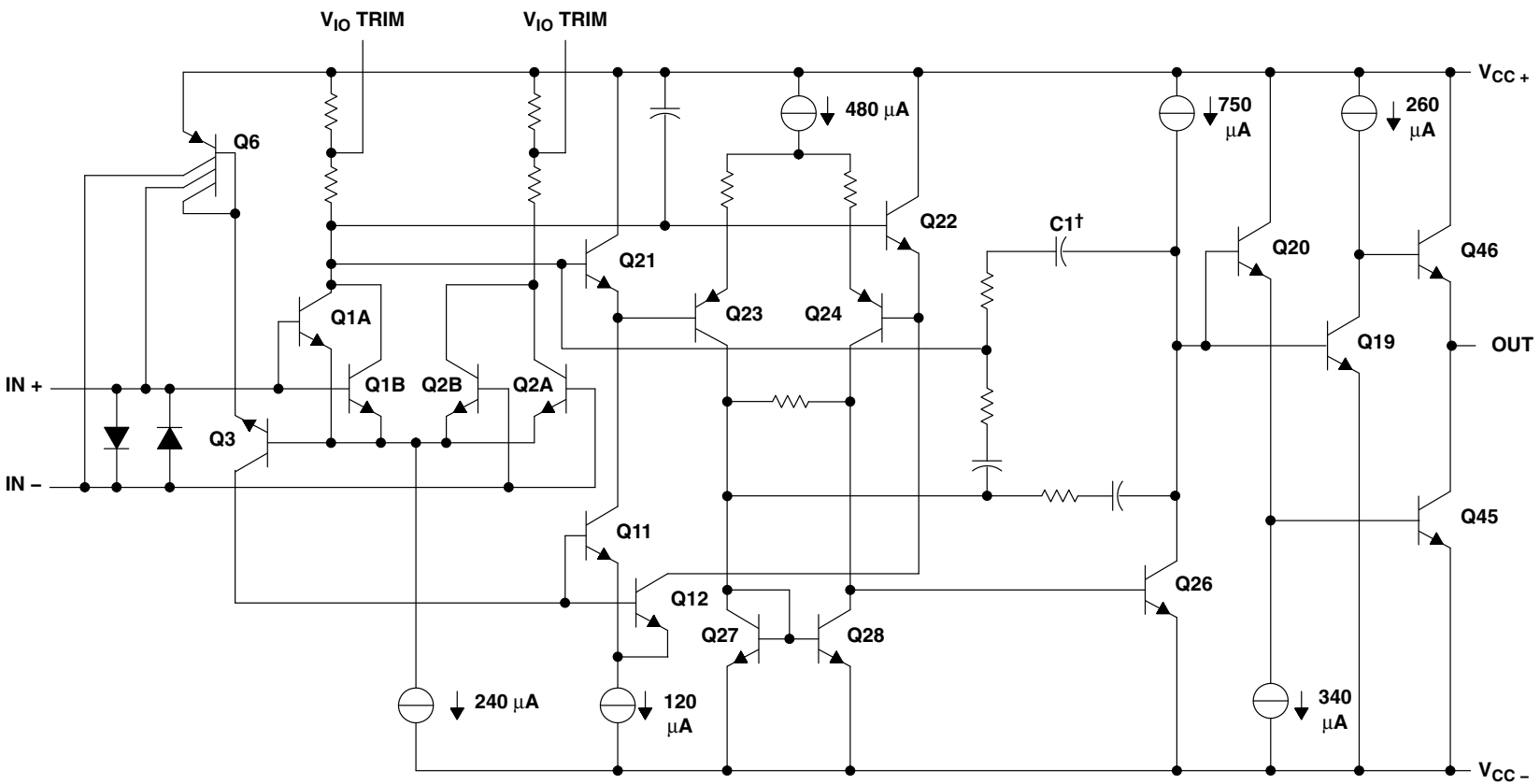

† C1 = 120 pF for OP27

schematic

# OP27A, OP27C

## LOW-NOISE HIGH-SPEED PRECISION OPERATIONAL-AMPLIFIER

SLOS100E – FEBRUARY 1989 – REVISED FEBRUARY 2010

**absolute maximum ratings over operating free-air temperature range (unless otherwise noted)**

Supply voltage, $V_{CC+}$ (see Note 1) .....	22 V
Supply voltage, $V_{CC-}$ (see Note 1) .....	22 V
Input voltage, $V_I$ .....	$V_{CC\pm}$
Duration of output short circuit .....	unlimited
Differential input current (see Note 2) .....	$\pm 25$ mA
Continuous power dissipation .....	See Dissipation Rating Table
Operating free-air temperature range: OP27A, OP27C .....	$-55^{\circ}\text{C}$ to $125^{\circ}\text{C}$
Storage temperature range .....	$-65^{\circ}\text{C}$ to $150^{\circ}\text{C}$
Lead temperature 1,6 mm (1/16 inch) from case for 60 seconds: JG or FK package .....	$300^{\circ}\text{C}$

- NOTES: 1. All voltage values are with respect to the midpoint between  $V_{CC+}$  and  $V_{CC-}$  unless otherwise noted.  
 2. The inputs are protected by back-to-back diodes. Current-limiting resistors are not used in order to achieve low noise. Excessive input current will flow if a differential input voltage in excess of approximately  $\pm 0.7$  V is applied between the inputs unless some limiting resistance is used.

**DISSIPATION RATING TABLE**

PACKAGE	$T_A \leq 25^{\circ}\text{C}$ POWER RATING	DERATING FACTOR ABOVE $T_A = 25^{\circ}\text{C}$	$T_A = 85^{\circ}\text{C}$ POWER RATING	$T_A = 125^{\circ}\text{C}$ POWER RATING
JG	1050 mW	8.4 mW/ $^{\circ}\text{C}$	546 mW	210 mW
FK	1375 mW	11.0 mW/ $^{\circ}\text{C}$	715 mW	275 mW



# OP27A, OP27C LOW-NOISE HIGH-SPEED PRECISION OPERATIONAL-AMPLIFIER

SLOS100E – FEBRUARY 1989 – REVISED FEBRUARY 2010

## recommended operating conditions

		OP27A			OP27C			UNIT
		MIN	NOM	MAX	MIN	NOM	MAX	
Supply voltage, $V_{CC+}$		4	15	22	4	15	22	V
Supply voltage, $V_{CC-}$		-4	-15	-22	-4	-15	-22	V
Common-mode input voltage, $V_{IC}$	$V_{CC\pm} = \pm 15$ V, $T_A = 25^\circ\text{C}$	$\pm 11$			$\pm 11$			V
	$V_{CC\pm} = \pm 15$ V, $T_A = -55^\circ\text{C}$ to $125^\circ\text{C}$	$\pm 10.3$			$\pm 10.2$			
Operating free-air temperature, $T_A$		-55		125	-55		125	$^\circ\text{C}$

## electrical characteristics at specified free-air temperature, $V_{CC\pm} = \pm 15$ V (unless otherwise noted)

PARAMETER		TEST CONDITIONS	$T_A^\dagger$	OP27A			OP27C			UNIT
				MIN	TYP	MAX	MIN	TYP	MAX	
$V_{IO}$	Input offset voltage	$V_O = 0$ , $R_S = 50 \Omega$ , $V_{IC} = 0$ See Note 3	25 $^\circ\text{C}$	10		25	30		100	$\mu\text{V}$
			Full range	60			300			
$\alpha_{VIO}$	Average temperature coefficient of input offset voltage		Full range	0.2	0.6	0.4		1.8	$\mu\text{V}/^\circ\text{C}$	
	Long-term drift of input offset voltage	See Note 4		0.2	1	0.4		2	$\mu\text{V}/\text{mo}$	
$I_{IO}$	Input offset current	$V_O = 0$ , $V_{IC} = 0$	25 $^\circ\text{C}$	7		35	12		75	nA
			Full range	50			135			
$I_{IB}$	Input bias current	$V_O = 0$ , $V_{IC} = 0$	25 $^\circ\text{C}$	$\pm 10$		$\pm 40$	$\pm 15$		$\pm 80$	nA
			Full range	$\pm 60$			$\pm 150$			
$V_{ICR}$	Common-mode input voltage range		25 $^\circ\text{C}$	11 to -11		11 to -11				V
			Full range	10.3 to -10.3		10.5 to -10.5				
$V_{OM}$	Peak output voltage swing	$R_L \geq 2 \text{ k}\Omega$		$\pm 12$		$\pm 13.8$	$\pm 11.5$		$\pm 13.5$	V
				$\pm 10$		$\pm 11.5$	$\pm 10$		$\pm 11.5$	
			Full range	$\pm 11.5$			10.5			
$A_{VD}$	Large-signal differential voltage amplification	$R_L \geq 2 \text{ k}\Omega$ , $V_O = \pm 10$ V		1000	1800	700		1500	V/mV	
		$R_L \geq 1 \text{ k}\Omega$ , $V_O = \pm 10$ V		800		1500		1500		
		$R_L \geq 0.6 \text{ k}\Omega$ , $V_O = \pm 1$ V, $V_{CC\pm} = \pm 4$ V		250	700	200		500		
		$R_L \geq 2 \text{ k}\Omega$ , $V_O = \pm 10$ V	Full range	600			300			
$r_{i(CM)}$	Common-mode input resistance			3			2		G $\Omega$	
$r_o$	Output resistance	$V_O = 0$ , $I_O = 0$	25 $^\circ\text{C}$	70			70		$\Omega$	
CMRR	Common-mode rejection ratio	$V_{IC} = \pm 11$ V $V_{IC} = \pm 10$ V	25 $^\circ\text{C}$	114	126	100		120	dB	
			Full range	110			94			
$k_{SVR}$	Supply voltage rejection ratio	$V_{CC\pm} = \pm 4$ V to $\pm 18$ V $V_{CC\pm} = \pm 4.5$ V to $\pm 18$ V	25 $^\circ\text{C}$	100	120	94		118	dB	
			Full range	96			86			

$^\dagger$  Full range is  $-55^\circ\text{C}$  to  $125^\circ\text{C}$ .

- NOTES: 3. Input offset voltage measurements are performed by automatic test equipment approximately 0.5 seconds after applying power.  
4. Long-term drift of input offset voltage refers to the average trend line of offset voltage versus time over extended periods after the first 30 days of operation. Excluding the initial hour of operation, changes in  $V_{IO}$  during the first 30 days are typically 2.5  $\mu\text{V}$  (see Figure 3).



# OP27A, OP27C

## LOW-NOISE HIGH-SPEED PRECISION OPERATIONAL-AMPLIFIER

SLOS100E – FEBRUARY 1989 – REVISED FEBRUARY 2010

### OP27 operating characteristics, $V_{CC\pm} = \pm 15\text{ V}$ , $T_A = 25^\circ\text{C}$

PARAMETER		TEST CONDITIONS	OP27A			OP27C			UNIT	
			MIN	TYP	MAX	MIN	TYP	MAX		
SR	Slew rate	$A_{VD} \geq 1$ , $R_L \geq 2\text{ k}\Omega$	1.7	2.8		1.7	2.8		$\text{V}/\mu\text{s}$	
$V_{N(PP)}$	Peak-to-peak equivalent input noise voltage	$f = 0.1\text{ Hz to }10\text{ Hz}$ , $R_S = 20\ \Omega$ , See Figure 26		0.225	0.375		0.225	0.375		$\mu\text{V}$
$V_n$	Equivalent input noise voltage	$f = 10\text{ Hz}$ , $R_S = 20\ \Omega$		3.5	8		3.8	8	$\text{nV}/\sqrt{\text{Hz}}$	
		$f = 1\text{ kHz}$ , $R_S = 20\ \Omega$		3	4		3.2	4		
$I_n$	Equivalent input noise current	$f = 10\text{ Hz}$ , See Figure 27		5	25		5	25	$\text{pA}/\sqrt{\text{Hz}}$	
		$f = 1\text{ kHz}$ , See Figure 27		0.7	2.5		0.7	2.5		
	Gain-bandwidth product	$f = 100\text{ kHz}$	5	8		5	8		MHz	

# OP27A, OP27C LOW-NOISE HIGH-SPEED PRECISION OPERATIONAL-AMPLIFIER

SLOS100E – FEBRUARY 1989 – REVISED FEBRUARY 2010

## TYPICAL CHARACTERISTICS

Table of Graphs

			FIGURE
$V_{IO}$	Input offset voltage	vs Temperature	1
$\Delta V_{IO}$	Change in input offset voltage	vs Time after power on	2
		vs Time (long-term drift)	3
$I_{IO}$	Input offset current	vs Temperature	4
$I_{IB}$	Input bias current	vs Temperature	5
$V_{ICR}$	Common-mode input voltage range	vs Supply voltage	6
$V_{OM}$	Maximum peak output voltage	vs Load resistance	7
$V_{O(PP)}$	Maximum peak-to-peak output voltage	vs Frequency	8
$A_{VD}$	Differential voltage amplification	vs Supply voltage	9
		vs Load resistance	10
		vs Frequency	11, 12
CMRR	Common-mode rejection ratio	vs Frequency	13
$k_{SVR}$	Supply voltage rejection ratio	vs Frequency	14
SR	Slew rate	vs Temperature	15
$\phi_m$	Phase margin	vs Temperature	16
$\phi$	Phase shift	vs Frequency	11
$V_n$	Equivalent input noise voltage	vs Bandwidth	17
		vs Source resistance	18
		vs Supply voltage	19
		vs Temperature	20
		vs Frequency	21
	Gain-bandwidth product	vs Temperature	16
$I_{OS}$	Short-circuit output current	vs Time	22
$I_{CC}$	Supply current	vs Supply voltage	23
	Pulse response	Small signal	24
		Large signal	25



**TYPICAL CHARACTERISTICS**

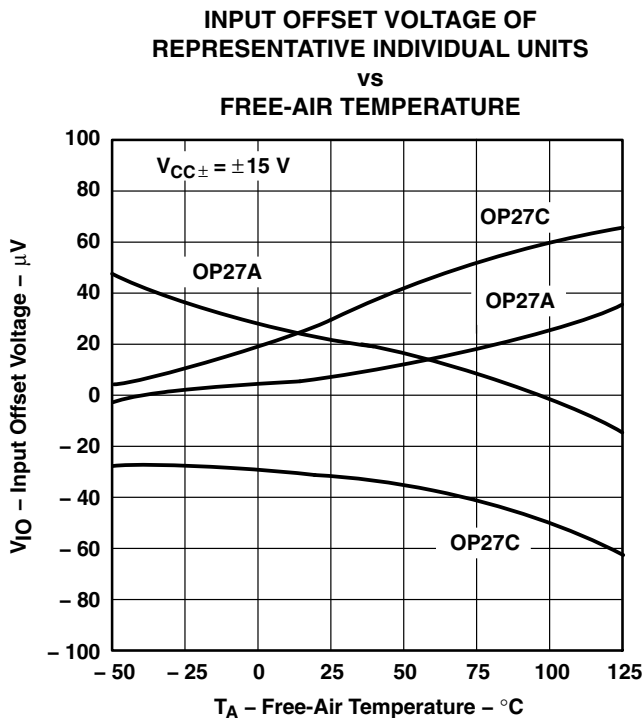

**Figure 1**

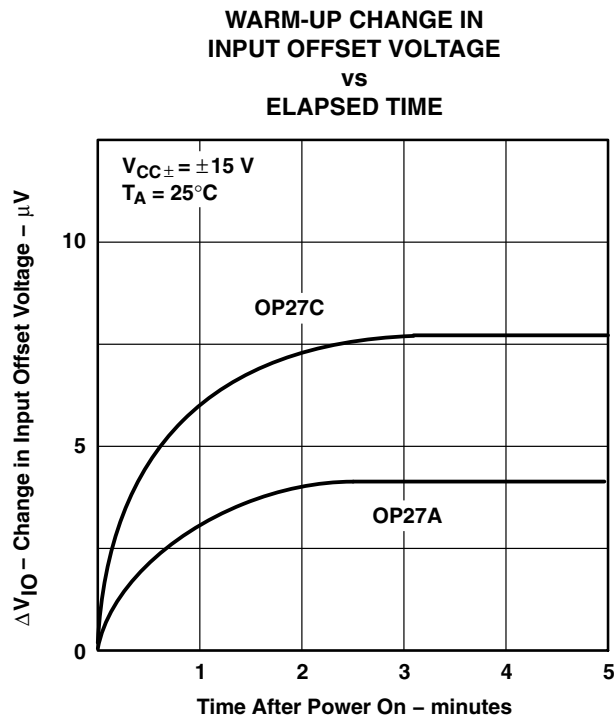

**Figure 2**

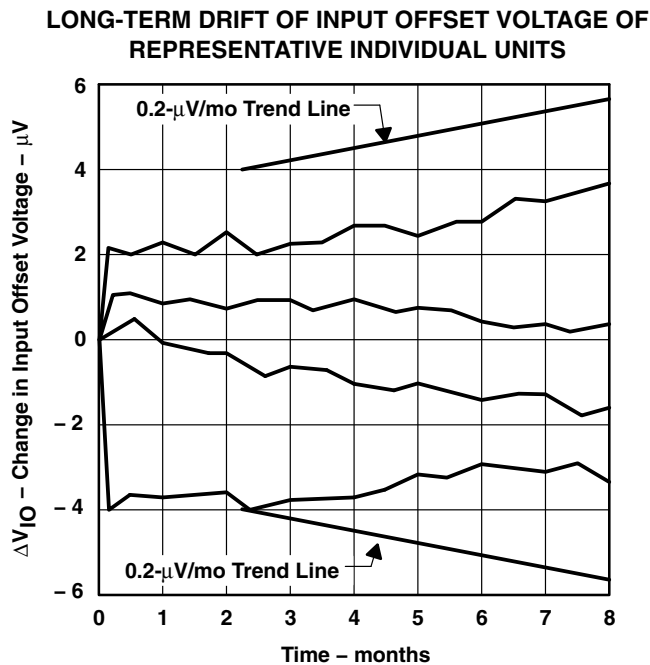

**Figure 3**

# OP27A, OP27C LOW-NOISE HIGH-SPEED PRECISION OPERATIONAL-AMPLIFIER

SLOS100E – FEBRUARY 1989 – REVISED FEBRUARY 2010

## TYPICAL CHARACTERISTICS

**INPUT OFFSET CURRENT  
vs  
FREE-AIR TEMPERATURE**

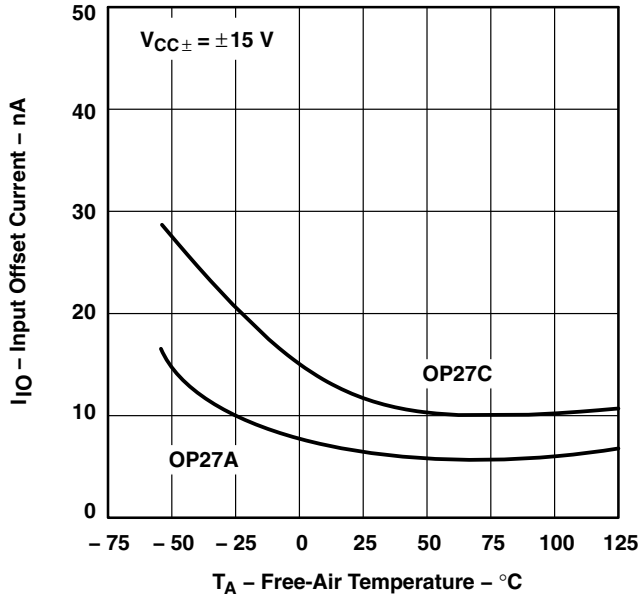

Figure 4

**INPUT BIAS CURRENT  
vs  
FREE-AIR TEMPERATURE**

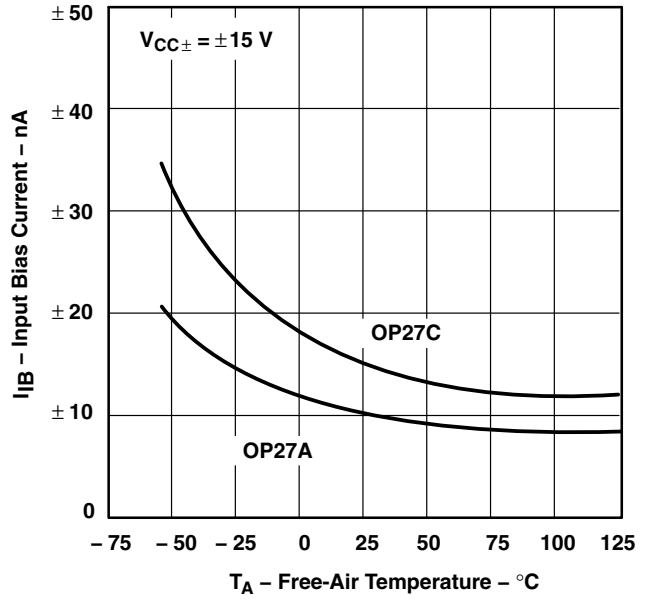

Figure 5

**COMMON-MODE INPUT VOLTAGE RANGE LIMITS  
vs  
SUPPLY VOLTAGE**

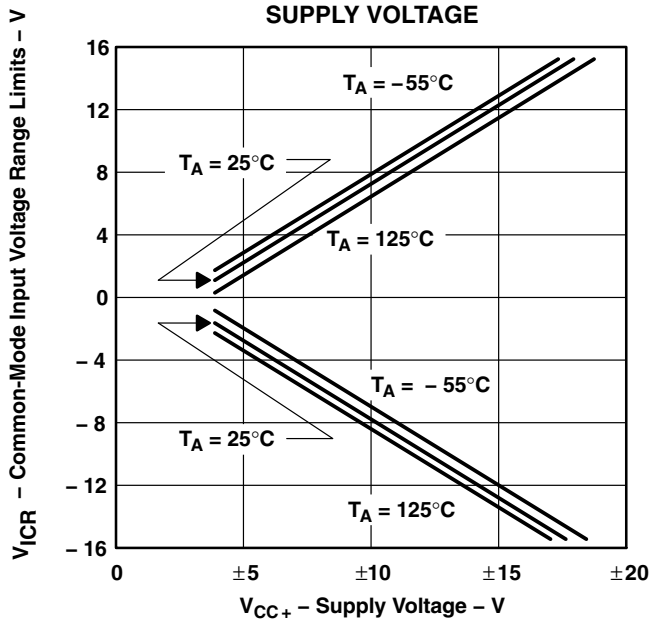

Figure 6

**MAXIMUM PEAK OUTPUT VOLTAGE  
vs  
LOAD RESISTANCE**

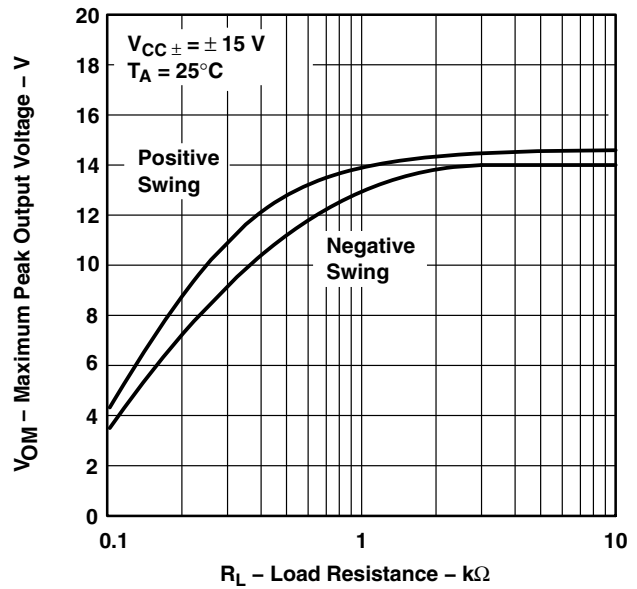

Figure 7





**TYPICAL CHARACTERISTICS**

**OP27**  
**MAXIMUM PEAK-TO-PEAK**  
**OUTPUT VOLTAGE**  
**vs**  
**FREQUENCY**

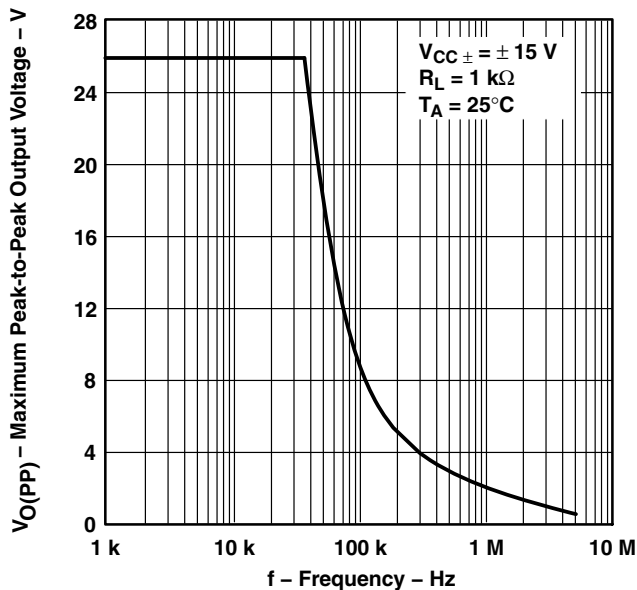

Figure 8.

**OP27A**  
**LARGE-SIGNAL**  
**DIFFERENTIAL VOLTAGE AMPLIFICATION**  
**vs**  
**TOTAL SUPPLY VOLTAGE**

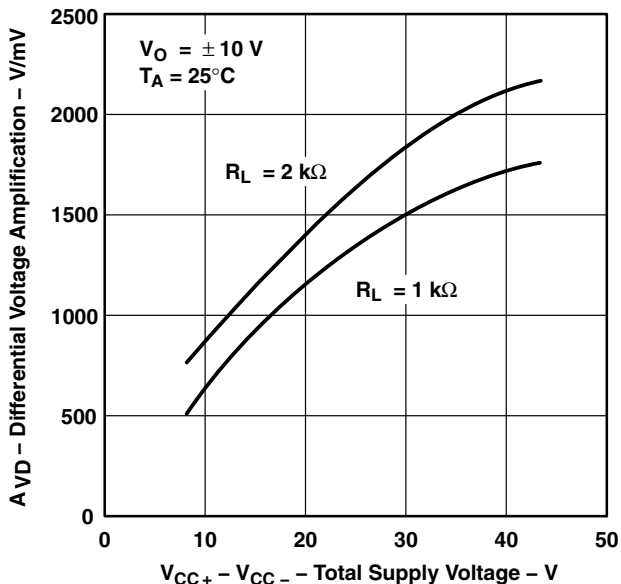

Figure 9

**OP27A**  
**LARGE-SIGNAL**  
**DIFFERENTIAL VOLTAGE AMPLIFICATION**  
**vs**  
**LOAD RESISTANCE**

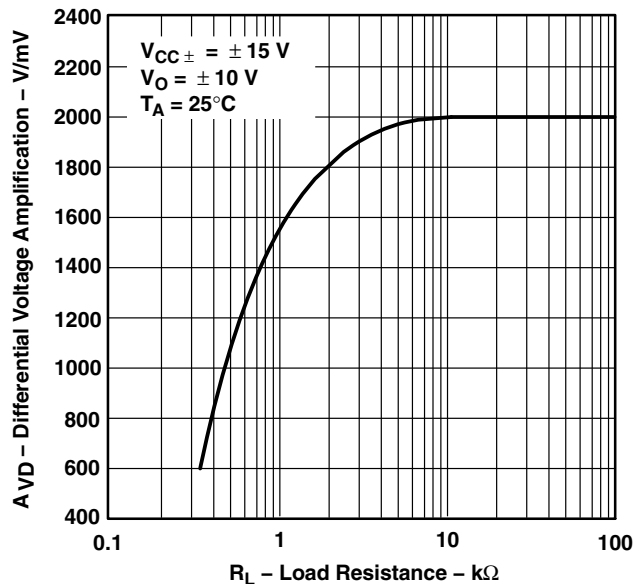

Figure 10

# OP27A, OP27C LOW-NOISE HIGH-SPEED PRECISION OPERATIONAL-AMPLIFIER

SLOS100E – FEBRUARY 1989 – REVISED FEBRUARY 2010

## TYPICAL CHARACTERISTICS

OP27  
LARGE-SIGNAL DIFFERENTIAL  
VOLTAGE AMPLIFICATION AND PHASE SHIFT  
vs  
FREQUENCY

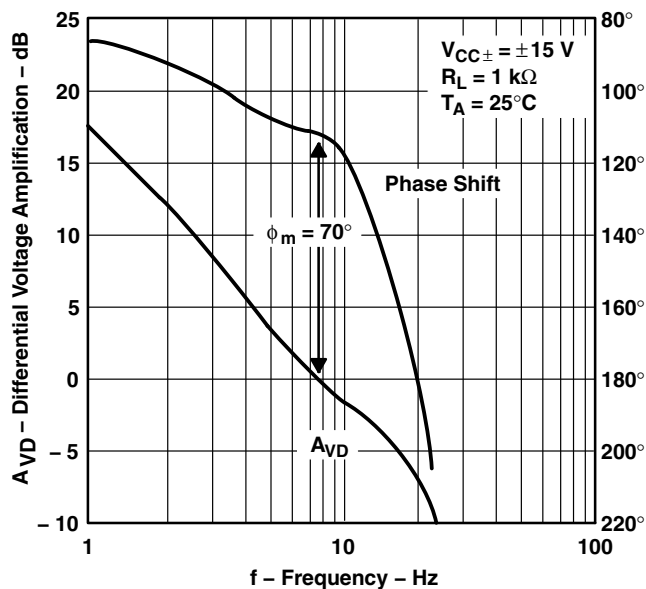

Figure 11.

OP27A  
LARGE-SIGNAL  
DIFFERENTIAL VOLTAGE AMPLIFICATION  
vs  
FREQUENCY

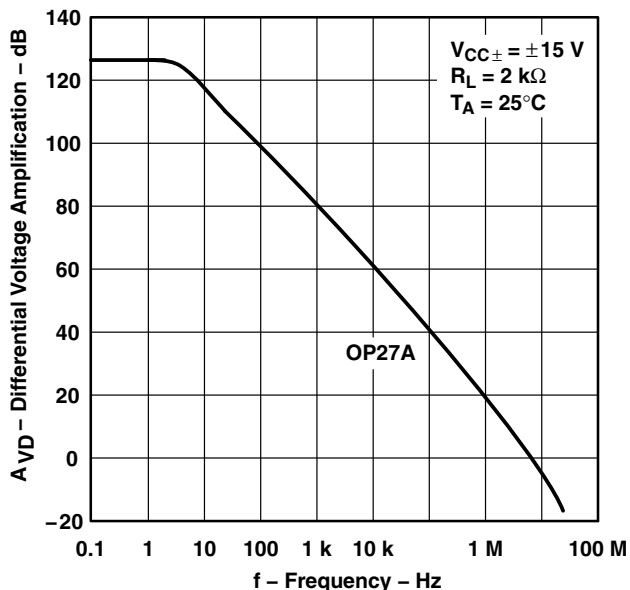

Figure 12

OP27A  
COMMON-MODE REJECTION RATIO  
vs  
FREQUENCY

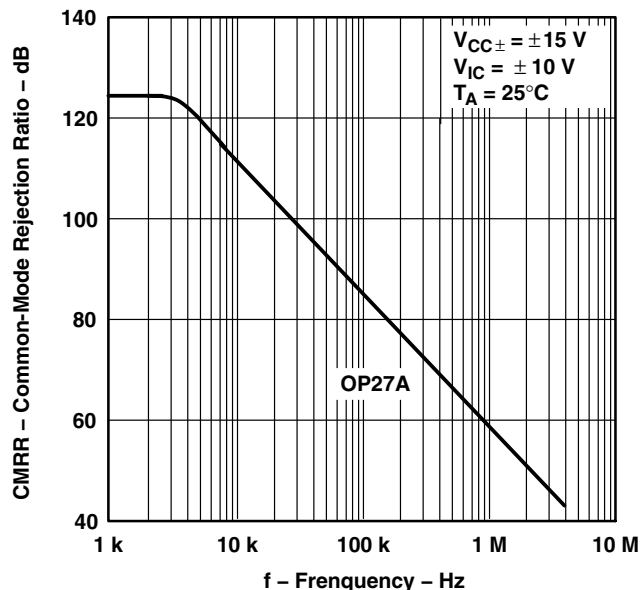

Figure 13



**TYPICAL CHARACTERISTICS**

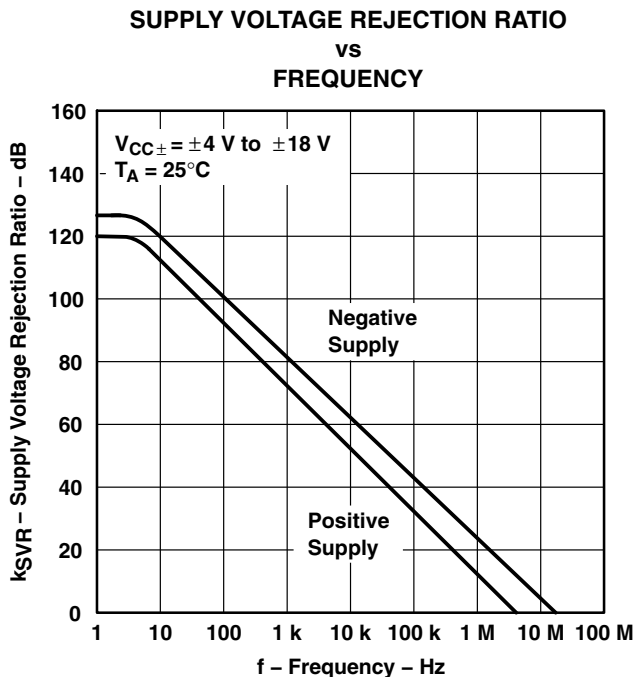

Figure 14

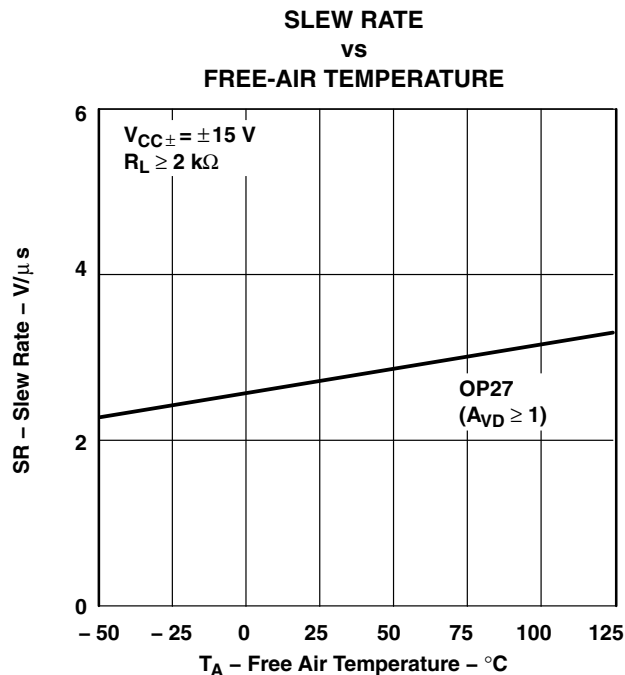

Figure 15

**OP27  
PHASE MARGIN AND  
GAIN-BANDWIDTH PRODUCT  
vs  
FREE-AIR TEMPERATURE**

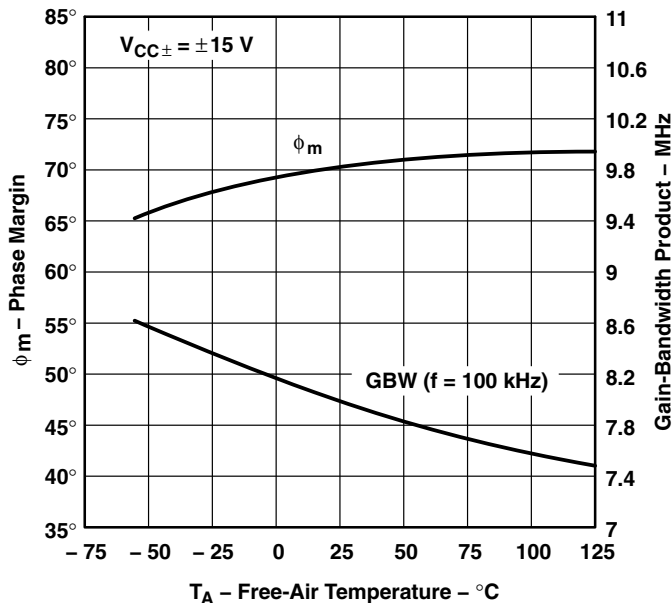

Figure 16.

# OP27A, OP27C LOW-NOISE HIGH-SPEED PRECISION OPERATIONAL-AMPLIFIER

SLOS100E – FEBRUARY 1989 – REVISED FEBRUARY 2010

## TYPICAL CHARACTERISTICS

**EQUIVALENT INPUT NOISE VOLTAGE  
vs  
BANDWIDTH**

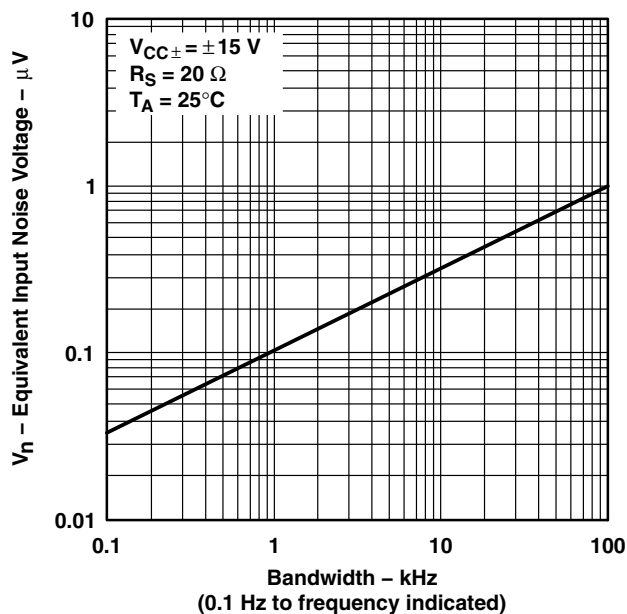

Figure 17

**OP27A  
EQUIVALENT INPUT NOISE VOLTAGE  
vs  
TOTAL SUPPLY VOLTAGE**

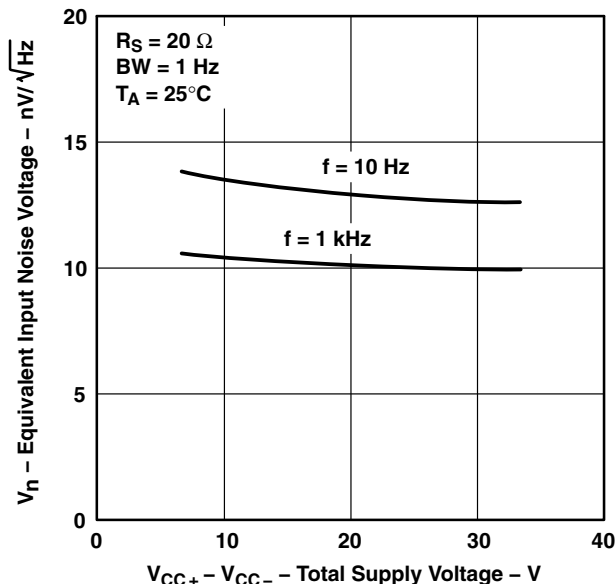

Figure 19

**TOTAL EQUIVALENT INPUT NOISE VOLTAGE  
vs  
SOURCE RESISTANCE**

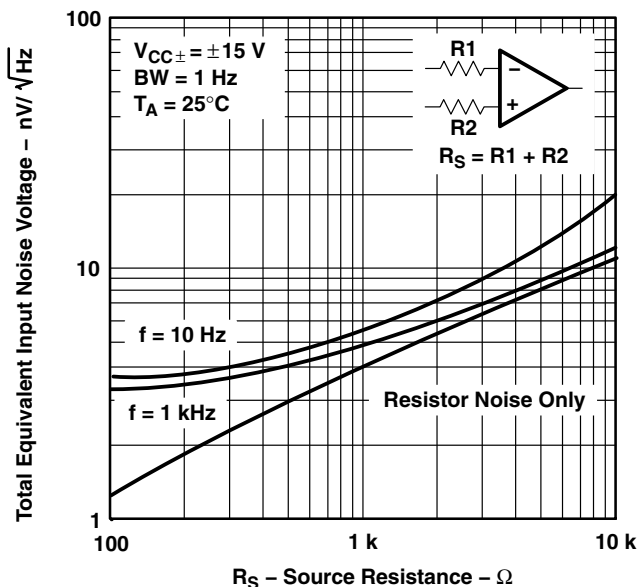

Figure 18

**OP27A  
EQUIVALENT INPUT NOISE VOLTAGE  
vs  
FREE-AIR TEMPERATURE**

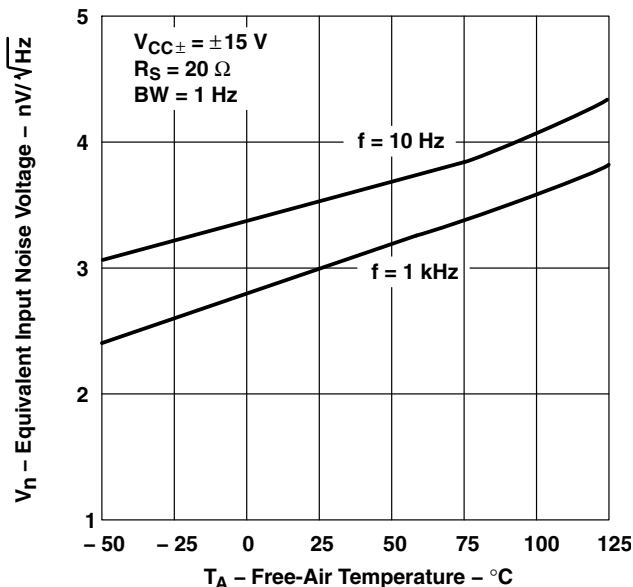
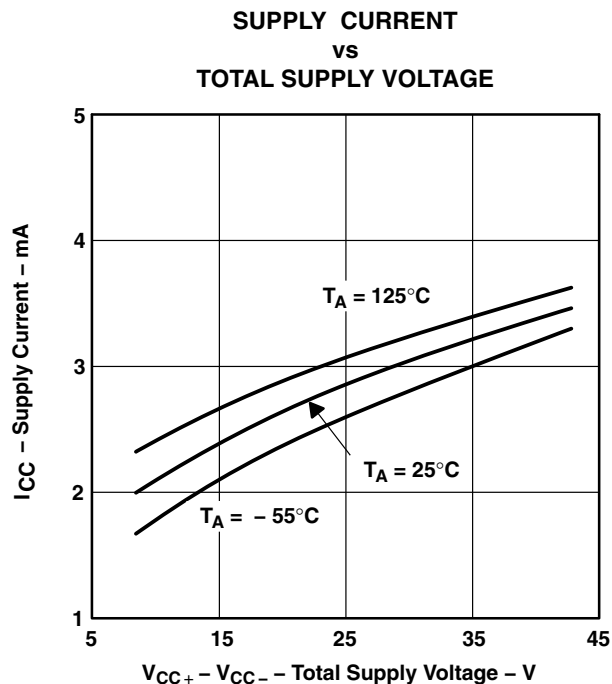
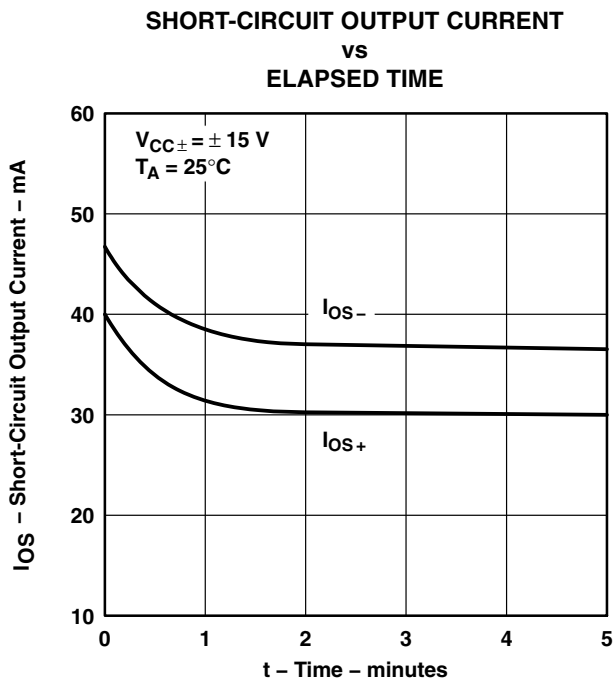
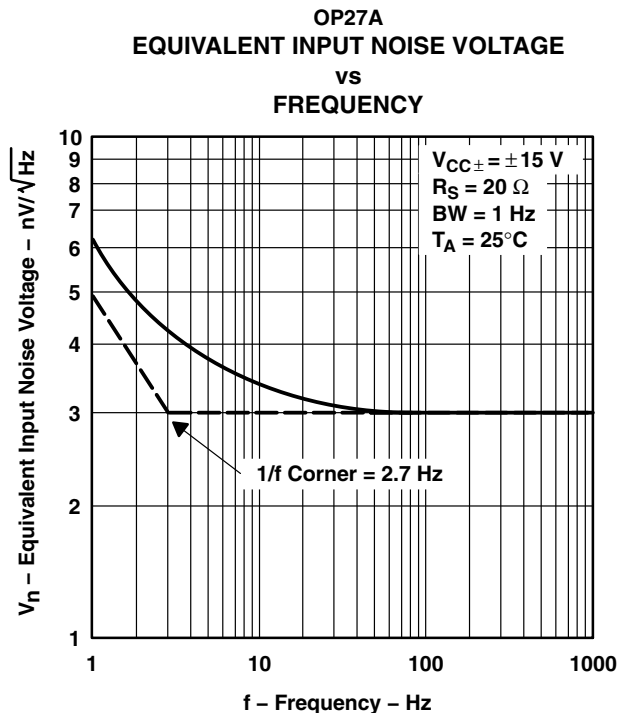

Figure 20



**TYPICAL CHARACTERISTICS**



# OP27A, OP27C LOW-NOISE HIGH-SPEED PRECISION OPERATIONAL-AMPLIFIER

SLOS100E – FEBRUARY 1989 – REVISED FEBRUARY 2010

## TYPICAL CHARACTERISTICS

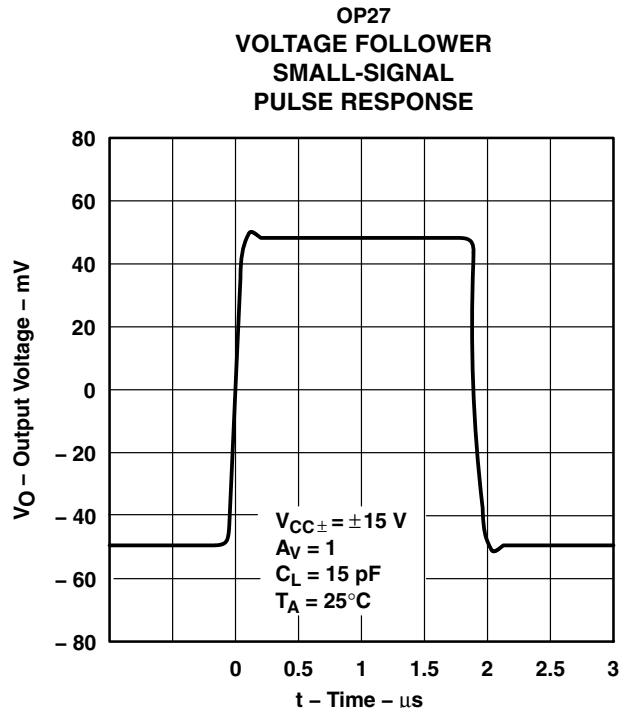

Figure 24

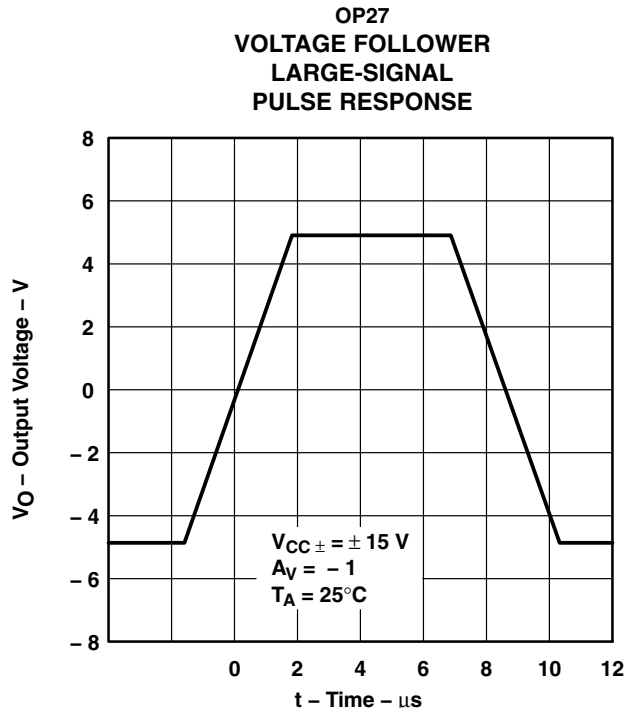

Figure 25

## APPLICATION INFORMATION

### general

The OP27 series devices can be inserted directly onto OP07, OP05,  $\mu\text{A}725$ , and SE5534 sockets with or without removing external compensation or nulling components. In addition, the OP27 can be fitted to  $\mu\text{A}741$  sockets by removing or modifying external nulling components.

### noise testing

Figure 26 shows a test circuit for 0.1-Hz to 10-Hz peak-to-peak noise measurement of the OP27. The frequency response of this noise tester indicates that the 0.1-Hz corner is defined by only one zero. Because the time limit acts as an additional zero to eliminate noise contributions from the frequency band below 0.1 Hz, the test time to measure 0.1-Hz to 10-Hz noise should not exceed 10 seconds.

Measuring the typical 80-nV peak-to-peak noise performance of the OP27 requires the following special test precautions:



**APPLICATION INFORMATION**

**noise testing (continued)**

1. The device should be warmed up for at least five minutes. As the operational amplifier warms up, the offset voltage typically changes  $4 \mu\text{V}$  due to the chip temperature increasing from  $10^\circ\text{C}$  to  $20^\circ\text{C}$  starting from the moment the power supplies are turned on. In the 10-s measurement interval, these temperature-induced effects can easily exceed tens of nanovolts.
2. For similar reasons, the device should be well shielded from air currents to eliminate the possibility of thermoelectric effects in excess of a few nanovolts, which would invalidate the measurements.
3. Sudden motion in the vicinity of the device should be avoided, as it produces a feedthrough effect that increases observed noise.

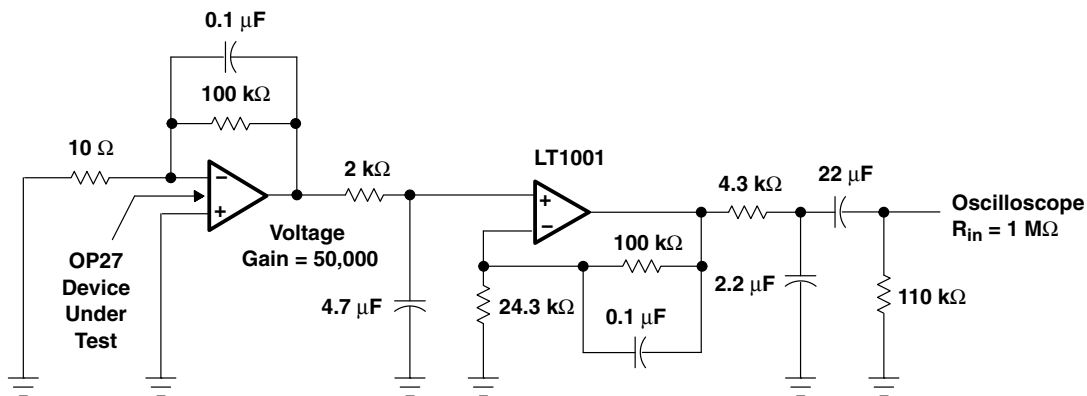
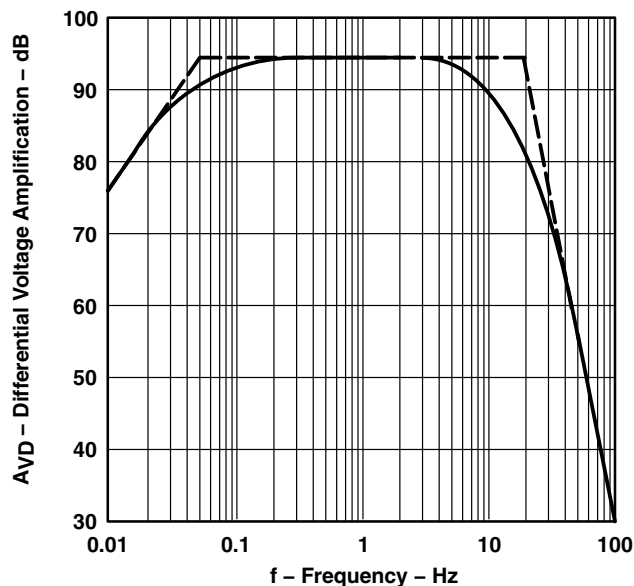

NOTE: All capacitor values are for nonpolarized capacitors only.

**Figure 26. 0.1-Hz to 10-Hz Peak-to-Peak Noise Test Circuit and Frequency Response**

# OP27A, OP27C LOW-NOISE HIGH-SPEED PRECISION OPERATIONAL-AMPLIFIER

SLOS100E – FEBRUARY 1989 – REVISED FEBRUARY 2010

## APPLICATION INFORMATION

### noise testing (continued)

When measuring noise on a large number of units, a noise-voltage density test is recommended. A 10-Hz noise-voltage density measurement correlates well with a 0.1-Hz to 10-Hz peak-to-peak noise reading since both results are determined by the white noise and the location of the 1/f corner frequency.

Figure 27 shows a circuit measuring current noise and the formula for calculating current noise.

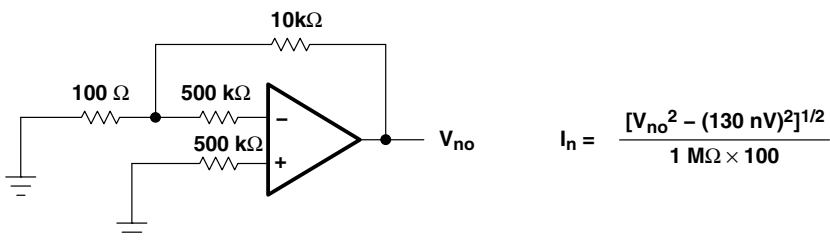

Figure 27. Current Noise Test Circuit and Formula

### offset voltage adjustment

The input offset voltage and temperature coefficient of the OP27 are permanently trimmed to a low level at wafer testing. However, if further adjustment of  $V_{IO}$  is necessary, using a 10-kΩ nulling potentiometer as shown in Figure 28 does not degrade the temperature coefficient  $\alpha_{V_{IO}}$ . Trimming to a value other than zero creates an  $\alpha_{V_{IO}}$  of  $V_{IO}/300 \mu\text{V}/^\circ\text{C}$ . For example, if  $V_{IO}$  is adjusted to 300  $\mu\text{V}$ , the change in  $\alpha_{V_{IO}}$  is 1  $\mu\text{V}/^\circ\text{C}$ .

The adjustment range with a 10-kΩ potentiometer is approximately  $\pm 2.5 \text{ mV}$ . If a smaller adjustment range is needed, the sensitivity and resolution of the nulling can be improved by using a smaller potentiometer in conjunction with fixed resistors. The example in Figure 29 has an approximate null range of  $\pm 200 \mu\text{V}$ .

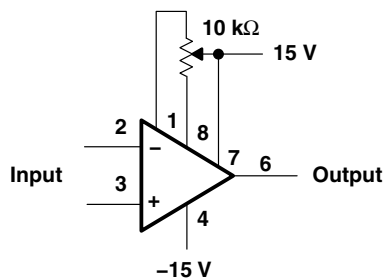

Figure 28. Standard Input Offset Voltage Adjustment

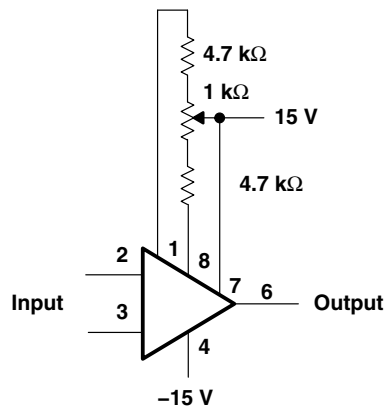

Figure 29. Input Offset Voltage Adjustment With Improved Sensitivity

### offset voltage and drift

Unless proper care is exercised, thermoelectric effects caused by temperature gradients across dissimilar metals at the contacts to the input terminals can exceed the inherent temperature coefficient  $\alpha_{V_{IO}}$  of the amplifier. Air currents should be minimized, package leads should be short, and the two input leads should be close together and at the same temperature.



**APPLICATION INFORMATION**

**offset voltage and drift (continued)**

The circuit shown in Figure 30 measures offset voltage. This circuit can also be used as the burn-in configuration for the OP27 with the supply voltage increased to 20 V,  $R_1 = R_3 = 10\text{ k}\Omega$ ,  $R_2 = 200\ \Omega$ , and  $A_{VD} = 100$ .

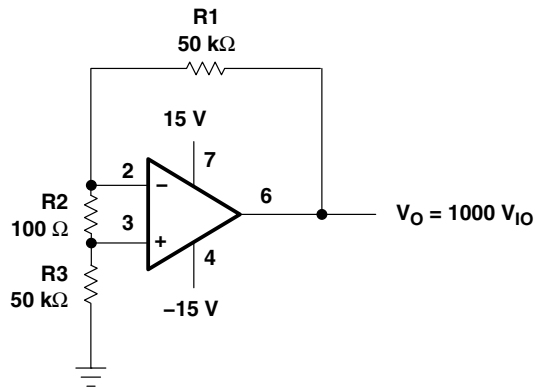

NOTE A: Resistors must have low thermoelectric potential.

**Figure 30. Test Circuit for Offset Voltage and Offset Voltage Temperature Coefficient**

**unity gain buffer applications**

The resulting output waveform, when  $R_f \leq 100\ \Omega$  and the input is driven with a fast large-signal pulse ( $>1\text{ V}$ ), is shown in the pulsed-operation diagram in Figure 31.

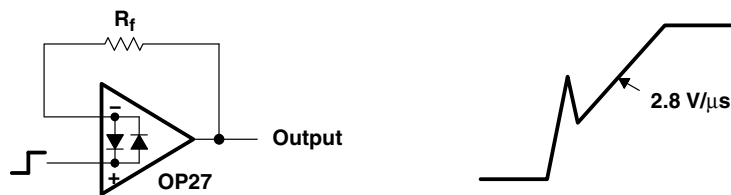

**Figure 31. Pulsed Operation**

During the initial (fast-feedthrough-like) portion of the output waveform, the input protection diodes effectively short the output to the input, and a current, limited only by the output short-circuit protection, is drawn by the signal generator. When  $R_f \geq 500\ \Omega$ , the output is capable of handling the current requirements (load current  $\leq 20\text{ mA}$  at  $10\text{ V}$ ), the amplifier stays in its active mode, and a smooth transition occurs. When  $R_f > 2\text{ k}\Omega$ , a pole is created with  $R_f$  and the amplifier's input capacitance, creating additional phase shift and reducing the phase margin. A small capacitor ( $20\text{ pF}$  to  $50\text{ pF}$ ) in parallel with  $R_f$  eliminates this problem.

# OP27A, OP27C LOW-NOISE HIGH-SPEED PRECISION OPERATIONAL-AMPLIFIER

SLOS100E – FEBRUARY 1989 – REVISED FEBRUARY 2010

## APPLICATION INFORMATION

### unity gain buffer applications (continued)

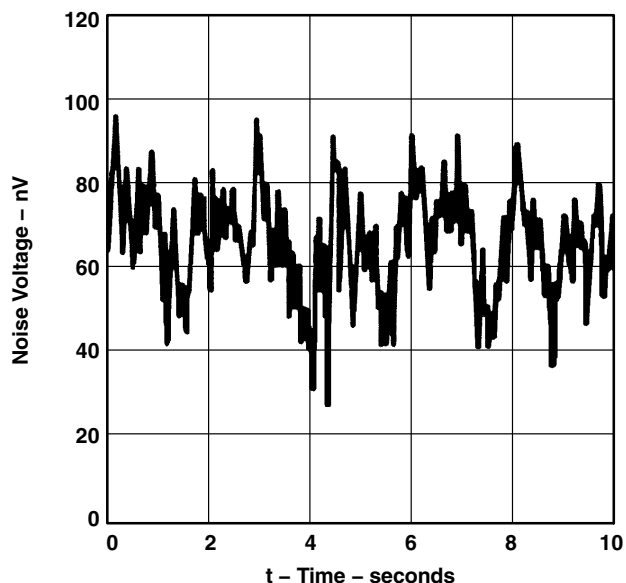

Type S Thermocouples  
5.4  $\mu\text{V}/^\circ\text{C}$  at  $0^\circ\text{C}$

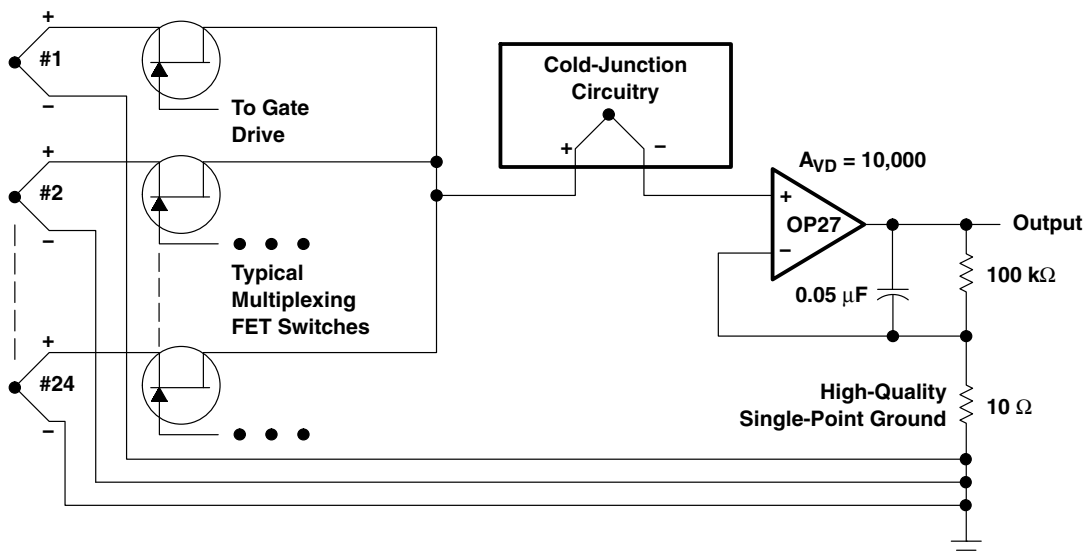

NOTE A: If 24 channels are multiplexed per second and the output is required to settle to 0.1 % accuracy, the amplifier's bandwidth cannot be limited to less than 30 Hz. The peak-to-peak noise contribution of the OP27 will still be only 0.11  $\mu\text{V}$ , which is equivalent to an error of only  $0.02^\circ\text{C}$ .

**Figure 32. Low-Noise, Multiplexed Thermocouple Amplifier and 0.1-Hz to 10-Hz Peak-to-Peak Noise Voltage**

**PACKAGING INFORMATION**

Orderable part number	Status (1)	Material type (2)	Package   Pins	Package qty   Carrier	RoHS (3)	Lead finish/ Ball material (4)	MSL rating/ Peak reflow (5)	Op temp (°C)	Part marking (6)
<a href="#">JM38510/13506BPA</a>	Active	Production	CDIP (JG)   8	50   TUBE	No	SNPB	N/A for Pkg Type	-55 to 125	JM38510 /13506BPA
JM38510/13506BPA.A	Active	Production	CDIP (JG)   8	50   TUBE	No	SNPB	N/A for Pkg Type	-55 to 125	JM38510 /13506BPA
<a href="#">OP27AFKB</a>	Active	Production	LCCC (FK)   20	55   TUBE	No	SNPB	N/A for Pkg Type	-	OP27AFKB
OP27AFKB.A	Active	Production	LCCC (FK)   20	55   TUBE	No	SNPB	N/A for Pkg Type	-55 to 125	OP27AFKB
<a href="#">OP27AJGB</a>	Active	Production	CDIP (JG)   8	50   TUBE	No	SNPB	N/A for Pkg Type	-	OP27AJGB
OP27AJGB.A	Active	Production	CDIP (JG)   8	50   TUBE	No	SNPB	N/A for Pkg Type	-55 to 125	OP27AJGB
<a href="#">OP27CJGB</a>	Active	Production	CDIP (JG)   8	50   TUBE	No	SNPB	N/A for Pkg Type	-	OP27CJGB
OP27CJGB.A	Active	Production	CDIP (JG)   8	50   TUBE	No	SNPB	N/A for Pkg Type	-55 to 125	OP27CJGB

(1) **Status:** For more details on status, see our [product life cycle](#).

(2) **Material type:** When designated, preproduction parts are prototypes/experimental devices, and are not yet approved or released for full production. Testing and final process, including without limitation quality assurance, reliability performance testing, and/or process qualification, may not yet be complete, and this item is subject to further changes or possible discontinuation. If available for ordering, purchases will be subject to an additional waiver at checkout, and are intended for early internal evaluation purposes only. These items are sold without warranties of any kind.

(3) **RoHS values:** Yes, No, RoHS Exempt. See the [TI RoHS Statement](#) for additional information and value definition.

(4) **Lead finish/Ball material:** Parts may have multiple material finish options. Finish options are separated by a vertical ruled line. Lead finish/Ball material values may wrap to two lines if the finish value exceeds the maximum column width.

(5) **MSL rating/Peak reflow:** The moisture sensitivity level ratings and peak solder (reflow) temperatures. In the event that a part has multiple moisture sensitivity ratings, only the lowest level per JEDEC standards is shown. Refer to the shipping label for the actual reflow temperature that will be used to mount the part to the printed circuit board.

(6) **Part marking:** There may be an additional marking, which relates to the logo, the lot trace code information, or the environmental category of the part.

Multiple part markings will be inside parentheses. Only one part marking contained in parentheses and separated by a "-" will appear on a part. If a line is indented then it is a continuation of the previous line and the two combined represent the entire part marking for that device.

**Important Information and Disclaimer:**The information provided on this page represents TI's knowledge and belief as of the date that it is provided. TI bases its knowledge and belief on information provided by third parties, and makes no representation or warranty as to the accuracy of such information. Efforts are underway to better integrate information from third parties. TI has taken and continues to take reasonable steps to provide representative

and accurate information but may not have conducted destructive testing or chemical analysis on incoming materials and chemicals. TI and TI suppliers consider certain information to be proprietary, and thus CAS numbers and other limited information may not be available for release.

In no event shall TI's liability arising out of such information exceed the total purchase price of the TI part(s) at issue in this document sold by TI to Customer on an annual basis.

**TUBE**

\*All dimensions are nominal

Device	Package Name	Package Type	Pins	SPQ	L (mm)	W (mm)	T (μm)	B (mm)
OP27AFKB	FK	LCCC	20	55	506.98	12.06	2030	NA
OP27AFKB.A	FK	LCCC	20	55	506.98	12.06	2030	NA

# PACKAGE OUTLINE

## JG0008A

### CDIP - 5.08 mm max height

CERAMIC DUAL IN-LINE PACKAGE



4230036/A 09/2023

#### NOTES:

1. All linear dimensions are in millimeters. Any dimensions in parenthesis are for reference only. Dimensioning and tolerancing per ASME Y14.5M.
2. This drawing is subject to change without notice.
3. This package can be hermetically sealed with a ceramic lid using glass frit.
4. Index point is provided on cap for terminal identification.
5. Falls within MIL STD 1835 GDIP1-T8

# EXAMPLE BOARD LAYOUT

JG0008A

CDIP - 5.08 mm max height

CERAMIC DUAL IN-LINE PACKAGE



LAND PATTERN EXAMPLE  
NON SOLDER MASK DEFINED  
SCALE: 9X

4230036/A 09/2023

## GENERIC PACKAGE VIEW

**FK 20**

**LCCC - 2.03 mm max height**

8.89 x 8.89, 1.27 mm pitch

LEADLESS CERAMIC CHIP CARRIER

This image is a representation of the package family, actual package may vary.  
Refer to the product data sheet for package details.



4229370VA\



## IMPORTANT NOTICE AND DISCLAIMER

TI PROVIDES TECHNICAL AND RELIABILITY DATA (INCLUDING DATASHEETS), DESIGN RESOURCES (INCLUDING REFERENCE DESIGNS), APPLICATION OR OTHER DESIGN ADVICE, WEB TOOLS, SAFETY INFORMATION, AND OTHER RESOURCES "AS IS" AND WITH ALL FAULTS, AND DISCLAIMS ALL WARRANTIES, EXPRESS AND IMPLIED, INCLUDING WITHOUT LIMITATION ANY IMPLIED WARRANTIES OF MERCHANTABILITY, FITNESS FOR A PARTICULAR PURPOSE OR NON-INFRINGEMENT OF THIRD PARTY INTELLECTUAL PROPERTY RIGHTS.

These resources are intended for skilled developers designing with TI products. You are solely responsible for (1) selecting the appropriate TI products for your application, (2) designing, validating and testing your application, and (3) ensuring your application meets applicable standards, and any other safety, security, regulatory or other requirements.

These resources are subject to change without notice. TI grants you permission to use these resources only for development of an application that uses the TI products described in the resource. Other reproduction and display of these resources is prohibited. No license is granted to any other TI intellectual property right or to any third party intellectual property right. TI disclaims responsibility for, and you fully indemnify TI and its representatives against any claims, damages, costs, losses, and liabilities arising out of your use of these resources.

TI's products are provided subject to [TI's Terms of Sale](#), [TI's General Quality Guidelines](#), or other applicable terms available either on [ti.com](http://ti.com) or provided in conjunction with such TI products. TI's provision of these resources does not expand or otherwise alter TI's applicable warranties or warranty disclaimers for TI products. Unless TI explicitly designates a product as custom or customer-specified, TI products are standard, catalog, general purpose devices.

TI objects to and rejects any additional or different terms you may propose.

Copyright © 2026, Texas Instruments Incorporated

Last updated 10/2025