

# LMR544xx SIMPLE SWITCHER® Power Converter 4V to 45V, 0.6A/1A Buck Converter in a SOT-23 Package

## 1 Features

- **Functional Safety-Capable**
  - Documentation available to aid functional safety system design
- Configured for rugged industrial applications
  - 4V to 36V input voltage range
  - Withstands up to 50V short  $V_{IN}$  transient
  - 0.6A/1A continuous output current
  - 60ns minimum switching on time
  - 1.1MHz fixed switching frequency
  - $-40^{\circ}\text{C}$  to  $150^{\circ}\text{C}$  junction temperature range
  - 98% maximum duty cycle
  - Monotonic start-up with prebiased output
  - Short-circuit protection with hiccup mode
  - Precision enable
  - $\pm 1\%$  tolerance voltage reference
- Small design size and ease of use
  - Integrated synchronous rectification
  - Internal compensation for ease of use
  - SOT-23 package
- Pin-to-pin compatible with the [LMR14010A](#), [LMR50410](#), and [TPS560430](#)
- Various options in pin-to-pin compatible package
  - PFM and forced PWM (FPWM) options

## 2 Applications

- Major appliances
- PLC, DCS, and PAC
- Smart meters
- General purpose wide  $V_{IN}$  power supplies

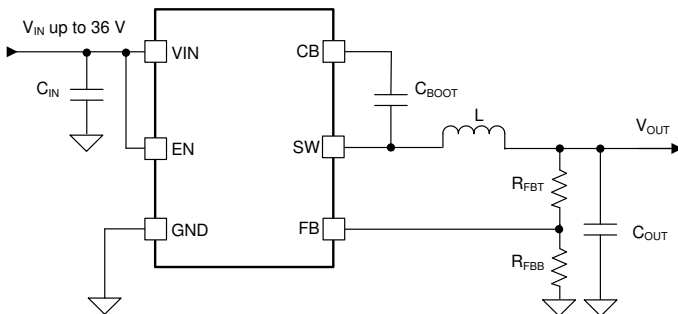

Simplified Schematic

## 3 Description

The LMR544xx is a wide- $V_{IN}$ , easy-to-use synchronous buck converter capable of driving up to 1A and 0.6A load current. With a wide input range of 4V to 36V, the device is designed for a wide range of industrial applications for power conditioning from an unregulated source.

The LMR544xx operates at 1.1MHz switching frequency to support use of relatively small inductors for an optimized design size. The devices have a **PFM version** to realize high efficiency at light load and a **FPWM version** to achieve constant frequency and small output voltage ripple over the full load range. Soft-start and compensation circuits are implemented internally, which allow the device to be used with minimal external components.

The device has built-in protection features, such as cycle-by-cycle current limit, hiccup mode short-circuit protection, and thermal shutdown in case of excessive power dissipation.

### Device Information

PART NUMBER <sup>(3)</sup>	PACKAGE <sup>(1)</sup>	PACKAGE SIZE <sup>(2)</sup>
LMR54410	DBV (SOT-23, 6)	2.90mm × 2.80mm
LMR54406		

- (1) For more information, see [Section 11](#).
- (2) The package size (length × width) is a nominal value and includes pins, where applicable.
- (3) See the [Device Comparison Table](#).

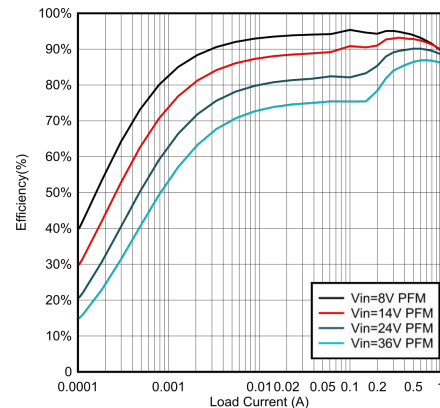

Efficiency Versus Output Current;  
 $V_{OUT} = 5V, 1100\text{kHz}$



## Table of Contents

<b>1 Features</b> .....	1	7.4 Device Functional Modes.....	18
<b>2 Applications</b> .....	1	<b>8 Application and Implementation</b> .....	19
<b>3 Description</b> .....	1	8.1 Application Information.....	19
<b>4 Device Comparison Table</b> .....	3	8.2 Typical Application.....	19
<b>5 Pin Configuration and Functions</b> .....	3	8.3 Power Supply Recommendations.....	25
<b>6 Specifications</b> .....	4	8.4 Layout.....	25
6.1 Absolute Maximum Ratings.....	4	<b>9 Device and Documentation Support</b> .....	28
6.2 ESD Ratings.....	4	9.1 Device Support.....	28
6.3 Recommended Operating Conditions.....	4	9.2 Documentation Support.....	28
6.4 Thermal Information.....	5	9.3 Receiving Notification of Documentation Updates....	28
6.5 Electrical Characteristics.....	5	9.4 Support Resources.....	28
6.6 Timing Requirements.....	7	9.5 Trademarks.....	28
6.7 System Characteristics.....	7	9.6 Electrostatic Discharge Caution.....	28
6.8 Typical Characteristics.....	8	9.7 Glossary.....	28
<b>7 Detailed Description</b> .....	11	<b>10 Revision History</b> .....	29
7.1 Overview.....	11	<b>11 Mechanical, Packaging, and Orderable Information</b> .....	29
7.2 Functional Block Diagram.....	12		
7.3 Feature Description.....	12		

## 4 Device Comparison Table

ORDERABLE PART NUMBER	OUTPUT CURRENT	FREQUENCY	PFM OR FPWM	OUTPUT
LMR54410DBVR	1A	1100kHz	PFM	Adjustable
LMR54410FDBVR	1A	1100kHz	FPWM	Adjustable
LMR54406DBVR	0.6A	1100kHz	PFM	Adjustable
LMR54406FDBVR	0.6A	1100kHz	FPWM	Adjustable

## 5 Pin Configuration and Functions

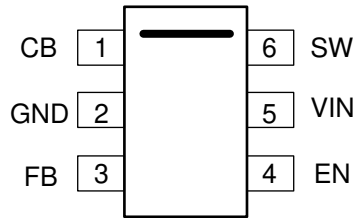

**Figure 5-1. 6-Pin SOT-23 DBV Package (Top View)**

**Table 5-1. Pin Functions**

PIN		TYPE <sup>(1)</sup>	DESCRIPTION
NAME	NO		
CB	1	P	Bootstrap capacitor connection for high-side FET driver. Connect a high quality 100nF capacitor from this pin to the SW pin.
GND	2	G	Power ground pins. Connected to the source of low-side FET internally. Connect to system ground, ground side of $C_{IN}$ and $C_{OUT}$ . The path to $C_{IN}$ must be as short as possible.
FB	3	A	Feedback input to the converter. Connect a resistor divider to set the output voltage. Never short this terminal to ground during operation.
EN	4	A	Precision enable input to the converter. Do not float. High = on, low = off. Can be tied to VIN. Precision enable input allows an adjustable UVLO by an external resistor divider.
VIN	5	P	Supply input pin to the internal bias LDO and high-side FET. Connect to the input supply and input bypass capacitors $C_{IN}$ . Input bypass capacitors must be directly connected to this pin and GND.
SW	6	P	Switching output of the converter. Internally connected to source of the high-side FET and drain of the low-side FET. Connect to the power inductor.

(1) A = Analog, P = Power, G = Ground

## 6 Specifications

### 6.1 Absolute Maximum Ratings

Over junction temperature range of  $-40^{\circ}\text{C}$  to  $150^{\circ}\text{C}$  (unless otherwise noted)<sup>(1)</sup>

		MIN	MAX	UNIT
Input voltage	VIN to GND <sup>(2)</sup>	-0.3	45 <sup>(3)</sup>	V
	EN to GND <sup>(2)</sup>	-0.3	V <sub>IN</sub> +0.3	V
	FB to GND	-0.3	5.5	V
Output voltage	SW to GND <sup>(2)</sup>	-0.3	V <sub>IN</sub> +0.3	V
Output voltage	SW to PGND less than 10ns transient	-5.0	V <sub>IN</sub> +0.3	V
	CBOOT to SW	-0.3	5.5	V
Junction Temperature T <sub>J</sub>		-40	150	°C
Storage temperature, T <sub>stg</sub>		-65	150	°C

- (1) Operation outside the *Absolute Maximum Ratings* may cause permanent device damage. Absolute Maximum Ratings do not imply functional operation of the device at these or any other conditions beyond those listed under Recommended Operating Conditions. If used outside the *Recommended Operating Conditions* but within the *Absolute Maximum Ratings*, the device may not be fully functional, and this may affect device reliability, functionality, performance, and shorten the device lifetime.
- (2) Absolute maximum ratings are rated under typical room temperature conditions. Stresses beyond those listed under *Absolute Maximum Ratings* may cause permanent damage to the device.
- (3) The DC max on device is 45V. A maximum of 50V can be sustained at this pin at room temperature for a duration of  $\leq 1\text{s}$  at a duty cycle of  $\leq 0.01\%$ . In short 100 $\mu\text{s}$  VIN transient at room temperature.

### 6.2 ESD Ratings

			VALUE	UNIT
V <sub>(ESD)</sub>	Electrostatic discharge	Human-body model (HBM), per ANSI/ESDA/JEDEC JS-001 <sup>(1)</sup>	$\pm 2500$	V
		Charged-device model (CDM), per ANSI/ESDA/JEDEC JS-002 <sup>(2)</sup>	$\pm 1000$	

- (1) JEDEC document JEP155 states that 500V HBM allows safe manufacturing with a standard ESD control process.
- (2) JEDEC document JEP157 states that 250V CDM allows safe manufacturing with a standard ESD control process.

### 6.3 Recommended Operating Conditions

Over the recommended operating junction temperature range of  $-40^{\circ}\text{C}$  to  $150^{\circ}\text{C}$  (unless otherwise noted)

		MIN	MAX	UNIT
Input voltage	VIN to GND	4	36	V
	EN to GND <sup>(1)</sup>	0	V <sub>IN</sub>	V
Output voltage	V <sub>OUT</sub> <sup>(2)</sup>	0.8	28	V
Output current	LMR54410	0	1	A
Output current	LMR54406	0	0.6	A

- (1) The voltage on this pin must not exceed the voltage on the VIN pin by more than 0.3V.
- (2) Under no conditions should the output voltage be allowed to fall below zero volts.

## 6.4 Thermal Information

THERMAL METRIC <sup>(1)</sup>		LMR544XX	
		DBV(SOT-23-6)	
		6 PINS	
			UNIT
R <sub>θJA</sub> <sup>(2)</sup>	Junction-to-ambient thermal resistance	173	°C/W
R <sub>θJC(top)</sub>	Junction-to-case (top) thermal resistance	116	°C/W
R <sub>θJB</sub>	Junction-to-board thermal resistance	31	°C/W
ψ <sub>JT</sub>	Junction-to-top characterization parameter	20	°C/W
ψ <sub>JB</sub>	Junction-to-board characterization parameter	30	°C/W

- (1) For more information about traditional and new thermal metrics, see the [Semiconductor and IC Package Thermal Metrics](#) application note.
- (2) The value of R<sub>θJA</sub> given in this table is only valid for comparison with other packages and cannot be used for design purposes. These values were calculated in accordance with JESD 51-7, and simulated on a 4-layer JEDEC board. They do not represent the performance obtained in an actual application. For example, with a 2-layer PCB, a R<sub>θJA</sub> = 80°C/W can be achieved. For design information see Maximum Output Current versus Ambient Temperature.

## 6.5 Electrical Characteristics

Limits apply over operating junction temperature (T<sub>J</sub>) range of –40°C to +150°C, unless otherwise stated. Minimum and Maximum limits are specified through test, design or statistical correlation. Typical values represent the most likely parametric norm at T<sub>J</sub> = 25°C, and are provided for reference purposes only. Unless otherwise stated, the following conditions apply: V<sub>IN</sub> = 4V to 36V.

PARAMETER		TEST CONDITIONS	MIN	TYP	MAX	UNIT
<b>SUPPLY VOLTAGE (VIN PIN)</b>						
V <sub>IN_UVLO</sub>	Undervoltage lockout thresholds	Rising threshold	3.55	3.75	4	V
		Falling threshold	3.25	3.45	3.65	V
		Hysteresis		0.3		V
I <sub>Q-nonSW</sub>	Operating quiescent current (non-switching) <sup>(1)</sup>	V <sub>EN</sub> = 3.3V, V <sub>FB</sub> =1.1V (PFM variant only)		80	120	μA
I <sub>SD</sub>	Shutdown quiescent current; measured at VIN pin	V <sub>EN</sub> = 0V		3	10	μA
<b>ENABLE (EN PIN)</b>						
V <sub>EN-VOUT-H</sub>	Enable input high-level for V <sub>OUT</sub>	V <sub>ENABLE</sub> rising	1.1	1.23	1.36	V
V <sub>EN-VOUT-L</sub>	Enable input low-level for V <sub>OUT</sub>	V <sub>ENABLE</sub> falling	0.95	1.1	1.22	V
V <sub>EN-VOUT-HYS</sub>	Enable input hysteresis for V <sub>OUT</sub>	Hysteresis		130		mV
I <sub>LKG-EN</sub>	Enable input leakage current	V <sub>EN</sub> = 3.3V		10	200	nA
<b>VOLTAGE REFERENCE (FB PIN)</b>						
V <sub>FB</sub>	Feedback voltage		0.79	0.8	0.81	V
I <sub>LKG-FB</sub>	Feedback leakage current	FB = 1.2V		0.2		nA
<b>SWITCHING FREQUENCY</b>						
F <sub>OSC</sub>	Internal oscillator frequency		0.935	1.1	1.265	MHz
<b>CURRENT LIMITS AND HICCUP</b>						
I <sub>SC</sub>	High-side current limit <sup>(2)</sup>	LMR54410	1.25	1.6	1.9	A
I <sub>LS-LIMIT</sub>	Low-side current limit <sup>(2)</sup>	LMR54410	.9	1.1	1.3	A
I <sub>SC</sub>	High-side current limit <sup>(2)</sup>	LMR54406	.85	1.1	1.3	A
I <sub>LS-LIMIT</sub>	Low-side current limit <sup>(2)</sup>	LMR54406	.65	0.8	.95	A
I <sub>L-ZC</sub>	Zero cross detector threshold	PFM variants only		0.02		A
<b>MOSFETS</b>						
R <sub>DS-ON-HS</sub>	High-side MOSFET ON-resistance	T <sub>J</sub> =25 °C, V <sub>IN</sub> = 12V		450		mΩ
R <sub>DS-ON-LS</sub>	Low-side MOSFET ON-resistance	T <sub>J</sub> =25 °C, V <sub>IN</sub> = 12V		240		mΩ
<b>THERMAL SHUTDOWN</b>						

## 6.5 Electrical Characteristics (continued)

Limits apply over operating junction temperature ( $T_J$ ) range of  $-40^{\circ}\text{C}$  to  $+150^{\circ}\text{C}$ , unless otherwise stated. Minimum and Maximum limits are specified through test, design or statistical correlation. Typical values represent the most likely parametric norm at  $T_J = 25^{\circ}\text{C}$ , and are provided for reference purposes only. Unless otherwise stated, the following conditions apply:  $V_{IN} = 4\text{V}$  to  $36\text{V}$ .

PARAMETER		TEST CONDITIONS	MIN	TYP	MAX	UNIT
$T_{SD-Rising}$	Thermal shutdown	Shutdown threshold		170		$^{\circ}\text{C}$
$T_{SD-Falling}$	Thermal shutdown	Recovery threshold		158		$^{\circ}\text{C}$

- (1) This is the current used by the device open loop. It does not represent the total input current of the system when in regulation.
- (2) The current limit values in this table are tested, open loop, in production. They may differ from those found in a closed loop application.

## 6.6 Timing Requirements

Limits apply over operating junction temperature ( $T_J$ ) range of  $-40^{\circ}\text{C}$  to  $+150^{\circ}\text{C}$ , unless otherwise stated. Minimum and Maximum limits<sup>(1)</sup> are specified through test, design or statistical correlation. Typical values represent the most likely parametric norm at  $T_J = 25^{\circ}\text{C}$ , and are provided for reference purposes only. Unless otherwise stated, the following conditions apply:  $V_{IN} = 4\text{V} - 36\text{V}$ .

PARAMETER		TEST CONDITIONS	MIN	TYP	MAX	UNIT
$t_{ON-MIN}$	Minimum switch on-time	$I_{OUT} = 1\text{A}$		60		ns
$t_{OFF-MIN}$	Minimum switch off-time	$I_{OUT} = 1\text{A}$		110		ns
$t_{ON-MAX}$	Maximum switch on-time			7.5		$\mu\text{s}$
$t_{SS}$	Internal soft-start time			1.8		ms

- (1) MIN and MAX limits are 100% production tested at  $25^{\circ}\text{C}$ . Limits over the operating temperature range verified through correlation using Statistical Quality Control (SQC) methods. Limits are used to calculate Average Outgoing Quality Level (AOQL).

## 6.7 System Characteristics

The following specifications apply to a typical application circuit with nominal component values. Specifications in the typical (TYP) column apply to  $T_J = 25^{\circ}\text{C}$  only. Specifications in the minimum (MIN) and maximum (MAX) columns apply to the case of typical components over the temperature range of  $T_J = -40^{\circ}\text{C}$  to  $150^{\circ}\text{C}$ . These specifications are not ensured by production testing.

PARAMETER		TEST CONDITIONS	MIN	TYP	MAX	UNIT
$V_{IN}$	Operating input voltage range		4		36	V
$V_{OUT}$	Adjustable output voltage regulation <sup>(1)</sup>	PFM operation	-1.5%		2.5%	
$V_{OUT}$	Adjustable output voltage regulation <sup>(1)</sup>	FPWM operation	-1.5%		1.5%	
$I_{SUPPLY}$	Input supply current when in regulation	$V_{IN} = 12\text{V}$ , $V_{OUT} = 3.3\text{V}$ , $I_{OUT} = 0\text{A}$ , $R_{FBT} = 1\text{M}\Omega$ , PFM variant		90		$\mu\text{A}$
$D_{MAX}$	Maximum switch duty cycle <sup>(2)</sup>			98%		
$V_{HC}$	FB pin voltage required to trip short-circuit hiccup mode			0.325		V
$t_D$	Switch voltage dead time			2		ns
$T_{SD}$	Thermal shutdown temperature	Shutdown temperature		170		$^{\circ}\text{C}$
$T_{SD}$	Thermal shutdown temperature	Recovery temperature		158		$^{\circ}\text{C}$

- (1) Deviation in  $V_{OUT}$  from nominal output voltage value at  $V_{IN} = 24\text{V}$ ,  $I_{OUT} = 0\text{A}$  to full load  
(2) In dropout the switching frequency drops to increase the effective duty cycle. The lowest frequency is clamped at approximately:  $F_{MIN} = 1 / (t_{ON-MAX} + t_{OFF-MIN})$ .  $D_{MAX} = t_{ON-MAX} / (t_{ON-MAX} + t_{OFF-MIN})$ .

## 6.8 Typical Characteristics

$V_{IN} = 12V$ ,  $f_{SW} = 1100kHz$ ,  $T_A = 25^\circ C$ , unless otherwise specified.

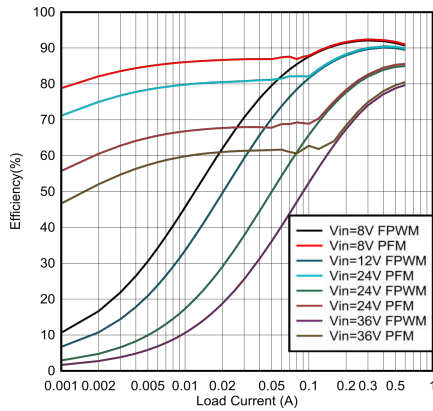

$f_{SW} = 1100kHz$   $V_{OUT} = 3.3V$  LMR54406

Figure 6-1. 3.3V Efficiency Versus Load Current

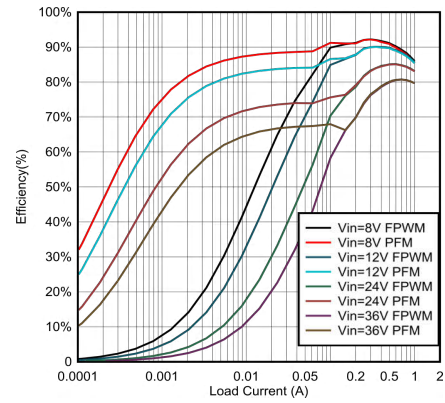

$f_{SW} = 1100kHz$   $V_{OUT} = 3.3V$  LMR54410

Figure 6-2. 3.3V Efficiency Versus Load Current

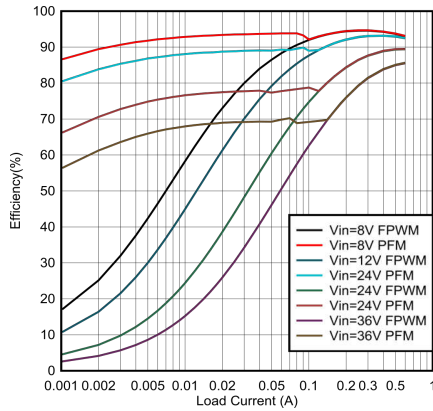

$f_{SW} = 1100kHz$   $V_{OUT} = 5V$  LMR54406

Figure 6-3. 5V Efficiency Versus Load Current

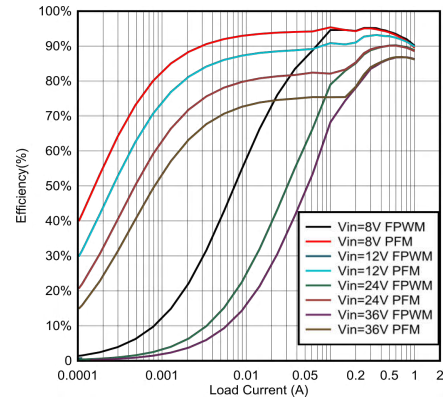

$f_{SW} = 1100kHz$   $V_{OUT} = 5V$  LMR54410

Figure 6-4. 5V Efficiency Versus Load Current

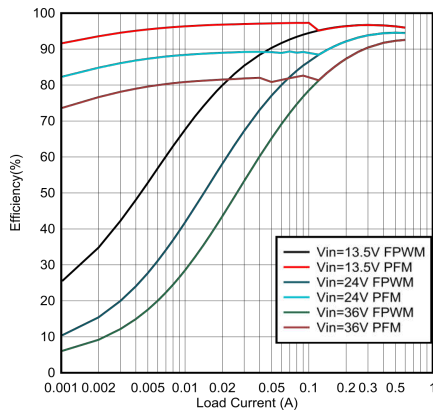

$f_{SW} = 1100kHz$   $V_{OUT} = 12V$  LMR54406

Figure 6-5. 12V Efficiency Versus Load Current

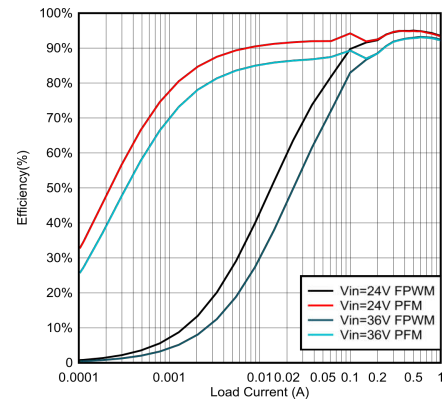

$f_{SW} = 1100kHz$   $V_{OUT} = 12V$  LMR54410

Figure 6-6. 12V Efficiency Versus Load Current

### 6.8 Typical Characteristics (continued)

$V_{IN} = 12V$ ,  $f_{SW} = 1100kHz$ ,  $T_A = 25^{\circ}C$ , unless otherwise specified.

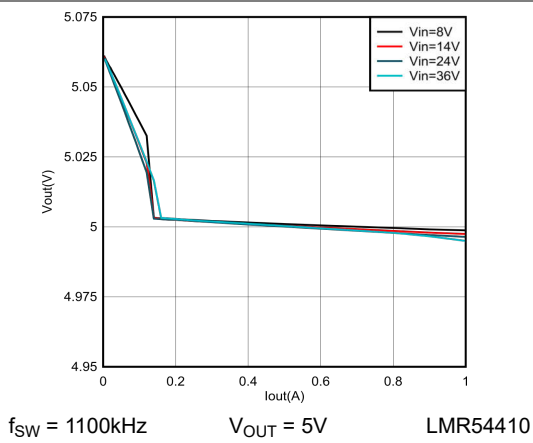

**Figure 6-7. 5V Load Regulation**

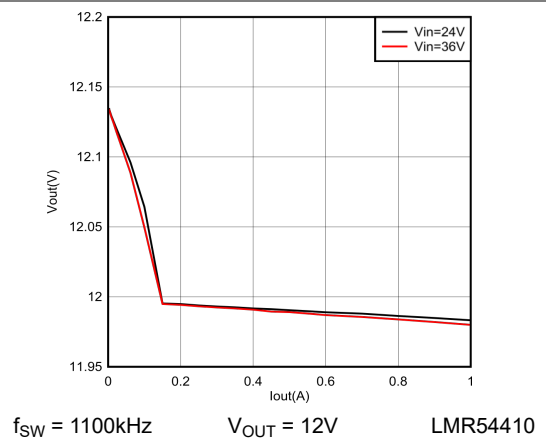

**Figure 6-8. 12V Load Regulation**

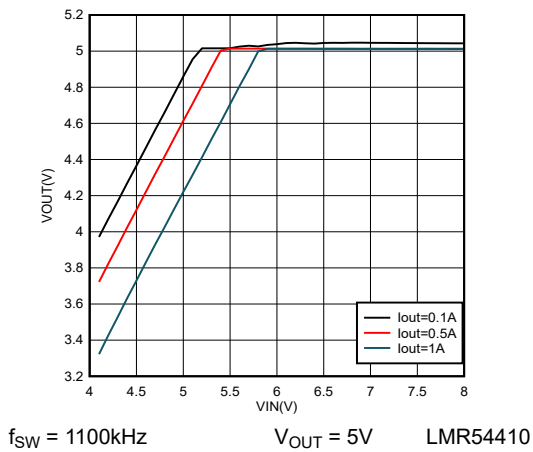

**Figure 6-9. 5V Dropout**

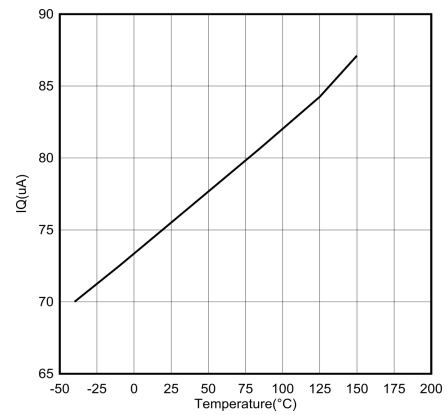

**Figure 6-10. IQ Versus Temperature**

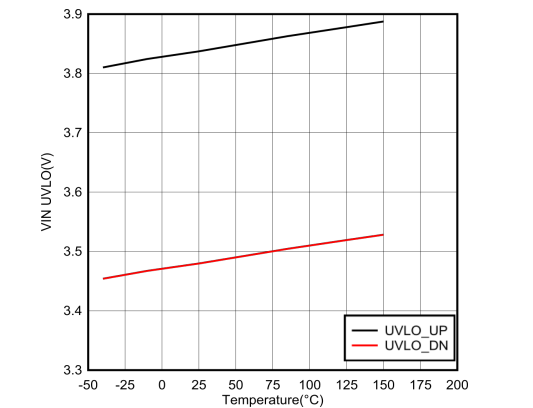

**Figure 6-11. VIN UVLO Versus Temperature**

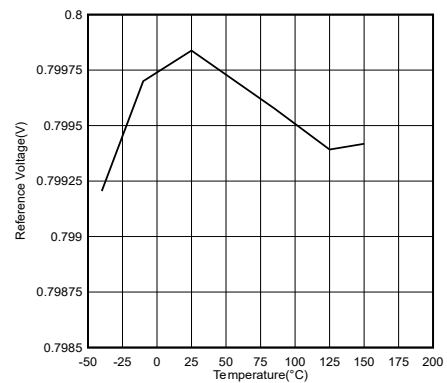

**Figure 6-12. Reference Voltage Versus Temperature**

### 6.8 Typical Characteristics (continued)

$V_{IN} = 12V$ ,  $f_{SW} = 1100kHz$ ,  $T_A = 25^\circ C$ , unless otherwise specified.

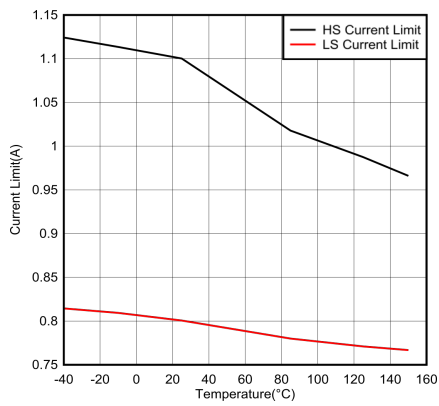

Figure 6-13. HS and LS Current Limit Versus Temperature- LMR54406

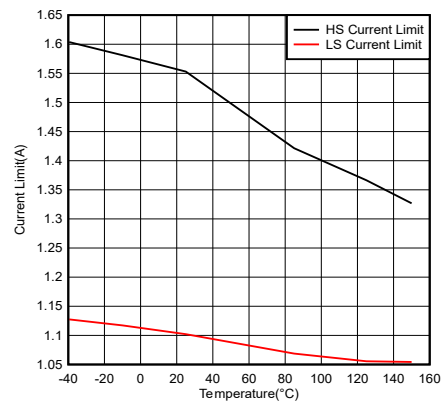

Figure 6-14. HS and LS Current Limit Versus Temperature- LMR54410

## 7 Detailed Description

### 7.1 Overview

The LMR544xx converter is an easy-to-use synchronous step-down DC-DC converter operating from a 4V to 36V supply voltage. The LMR54410 is capable of delivering up to 1A DC load current in a very small design size while the LMR54406 is capable of delivering up to 0.6A load current. The family has multiple versions applicable to various applications. See [Section 4](#) for detailed information.

The LMR544xx employs fixed-frequency peak-current mode control. The PFM version enters PFM mode at light load to achieve high efficiency. A FPWM version is provided to achieve low output voltage ripple, tight output voltage regulation, and constant switching frequency at light load. The device is internally compensated, which reduces design time and requires few external components.

Additional features, such as precision enable and internal soft start, provide a flexible and easy-to-use design for a wide range of applications. Protection features include the following:

- Thermal shutdown
- $V_{IN}$  undervoltage lockout
- Cycle-by-cycle current limit
- Hiccup mode short-circuit protection

This family of devices requires very few external components and has a pinout designed for simple, optimal PCB layout.





**Figure 7-1. SW Node and Inductor Current Waveforms in Continuous Conduction Mode (CCM)**

The LMR544xx employs fixed-frequency peak-current mode control. A voltage feedback loop is used to get accurate DC voltage regulation by adjusting the peak-current command based on voltage offset. The peak inductor current is sensed from the high-side switch and compared to the peak current threshold to control the ON time of the high-side switch. The voltage feedback loop is internally compensated, which allows for fewer external components, making designing easy and providing stable operation when using a variety of output capacitors. The converter operates with fixed switching frequency at normal load conditions. During light-load condition, the LMR544xx operates in PFM mode to maintain high efficiency (PFM version) or in FPWM mode for low output voltage ripple, tight output voltage regulation, and constant switching frequency (FPWM version).

### 7.3.2 Adjustable Output Voltage

A precision 0.8V reference voltage ( $V_{REF}$ ) is used to maintain a tightly regulated output voltage over the entire operating temperature range. The output voltage is set by a resistor divider from  $V_{OUT}$  to the FB pin. TI recommends to use 1% tolerance resistors with a low temperature coefficient for the FB divider. Select the bottom-side resistor,  $R_{FBB}$ , for the desired divider current and use Equation 1 to calculate the top-side resistor,  $R_{FBT}$ . The recommended range for  $R_{FBT}$  is 10k $\Omega$  to 100k $\Omega$ . A lower  $R_{FBT}$  value can be used if pre-loading is desired to reduce the  $V_{OUT}$  offset in PFM operation. Lower  $R_{FBT}$  values reduce efficiency at very light load. Less static current goes through a larger  $R_{FBT}$  value and can be more desirable when light-load efficiency is critical. However,  $R_{FBT}$  values larger than 1M $\Omega$  are not recommended because they make the feedback path more susceptible to noise. Larger  $R_{FBT}$  values require a more carefully designed feedback path trace from the feedback resistors to the feedback pin of the device. The tolerance and temperature variation of the resistor divider network affect the output voltage regulation.

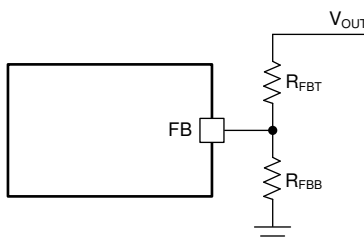

Figure 7-2. Output Voltage Setting

$$R_{FBT} = \frac{V_{OUT} - V_{REF}}{V_{REF}} \times R_{FBB} \quad (1)$$

### 7.3.3 Enable

The voltage on the EN pin controls the ON/OFF operation of the LMR544xx. A voltage of less than 0.95V shuts down the device, while a voltage of greater than 1.36V is required to start the converter. The EN pin is an input and cannot be left open or floating. The simplest way to enable the operation of the LMR544xx is to connect EN to  $V_{IN}$ . This allows self-start-up of the LMR544xx when  $V_{IN}$  is within the operating range.

Many applications benefit from the employment of an enable divider,  $R_{ENT}$  and  $R_{ENB}$  (Figure 7-3) to establish a precision system UVLO level for the converter. A system UVLO can be used for supplies operating from utility power as well as battery power. It can be used for sequencing, ensuring reliable operation, or supplying protection, such as a battery discharge level. An external logic signal can also be used to drive the EN input for system sequencing and protection.

#### Note

The EN pin voltage must not be greater than  $V_{IN} + 0.3V$ . TI does not recommend to apply EN voltage when  $V_{IN}$  is 0V.

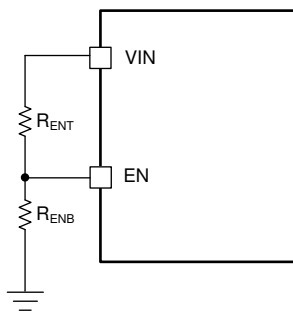

Figure 7-3. System UVLO by Enable Divider

### 7.3.4 Minimum ON Time, Minimum OFF Time, and Frequency Foldback

The minimum ON time ( $T_{ON\_MIN}$ ) is the shortest duration of time that the high-side switch can be turned on.  $T_{ON\_MIN}$  is typically 60ns for the LMR544xx. The minimum OFF time ( $T_{OFF\_MIN}$ ) is the shortest duration of time that the high-side switch can be off.  $T_{OFF\_MIN}$  is typically 110ns. In CCM operation,  $T_{ON\_MIN}$  and  $T_{OFF\_MIN}$  limit the voltage conversion range without switching frequency foldback.

The minimum duty cycle without frequency foldback allowed is:

$$D_{MIN} = T_{ON\_MIN} \times f_{SW} \quad (2)$$

The maximum duty cycle without frequency foldback allowed is:

$$D_{MAX} = 1 - T_{OFF\_MIN} \times f_{SW} \quad (3)$$

Given a required output voltage, the maximum  $V_{IN}$  without frequency foldback can be found by:

$$V_{IN\_MAX} = \frac{V_{OUT}}{f_{SW} \times T_{ON\_MIN}} \quad (4)$$

The minimum  $V_{IN}$  without frequency foldback can be calculated by:

$$V_{IN\_MIN} = \frac{V_{OUT}}{1 - f_{SW} \times T_{OFF\_MIN}} \quad (5)$$

In the LMR544xx, a frequency foldback scheme is employed after the  $T_{ON\_MIN}$  or  $T_{OFF\_MIN}$  is triggered, which can extend the maximum duty cycle or lower the minimum duty cycle.

The on time decreases while  $V_{IN}$  voltage increases. After the on time decreases to  $T_{ON\_MIN}$ , the switching frequency starts to decrease while  $V_{IN}$  continues to go up, which lowers the duty cycle further to keep  $V_{OUT}$  in regulation according to [Equation 2](#).

The frequency foldback scheme also works after larger duty cycle is needed under a low  $V_{IN}$  condition. The frequency decreases after the device hits its  $T_{OFF\_MIN}$ , which extends the maximum duty cycle according to [Equation 3](#). In such condition, the frequency can be as low as approximately 133kHz. A wide range of frequency foldback allows for the LMR544xx output voltage to stay in regulation with a much lower supply voltage  $V_{IN}$ , which leads to a lower effective dropout.

With frequency foldback while maintaining a regulated output voltage,  $V_{IN\_MAX}$  is raised and  $V_{IN\_MIN}$  is lowered by decreased  $f_{SW}$ .

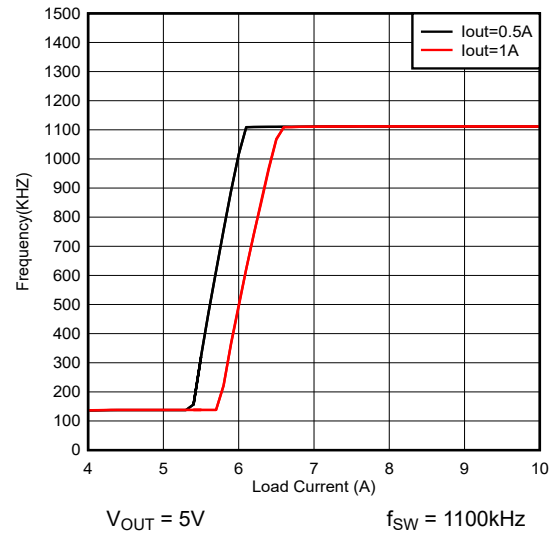
Figure 7-4. Frequency Foldback at T<sub>ON\_MIN</sub>Figure 7-5. Frequency Foldback at T<sub>OFF\_MIN</sub>

### 7.3.5 Bootstrap Voltage

The LMR544xx provides an integrated bootstrap voltage converter. A small capacitor between the CB and SW pins provides the gate drive voltage for the high-side MOSFET. The bootstrap capacitor is refreshed when the high-side MOSFET is off and the low-side switch is on. The recommended value of the bootstrap capacitor is 0.1µF. A ceramic capacitor with an X7R or X5R grade dielectric with a voltage rating of 16V or higher is recommended for stable performance over temperature and voltage.

### 7.3.6 Overcurrent and Short Circuit Protection

The LMR544xx incorporates both peak and valley inductor current limit to provide protection to the device from overloads and short circuits and limit the maximum output current. Valley current limit prevents inductor current runaway during short circuits on the output, while both peak and valley limits work together to limit the maximum output current of the converter. Cycle-by-cycle current limit is used for overloads, while hiccup mode is used for sustained short circuits.

High-side MOSFET overcurrent protection is implemented by the nature of the peak current mode control. The high-side switch current is sensed when the high-side is turned on after a set blanking time. The high-side switch current is compared to the output of the Error Amplifier (EA) minus slope compensation every switching cycle. See Section 7.2 for more details. The peak current of high-side switch is limited by a clamped maximum peak current threshold  $I_{sc}$  (see Section 6.5), which is constant.

The current going through the low-side MOSFET is also sensed and monitored. When the low-side switch turns on, the inductor current begins to ramp down. The low-side switch is not turned OFF at the end of a switching cycle if its current is above the low-side current limit,  $I_{LS\_LIMIT}$  (see Section 6.5). The low-side switch is kept ON so that inductor current keeps ramping down until the inductor current ramps below  $I_{LS\_LIMIT}$ . Then, the low-side switch is turned OFF and the high-side switch is turned on after a dead time. After  $I_{LS\_LIMIT}$  is achieved, peak and valley current limit controls the maximum current delivered and it can be calculated using Equation 6.

$$I_{OUT}|_{max} = \frac{I_{LS\_LIMIT} + I_{SC}}{2} \quad (6)$$

If the feedback voltage is lower than 40% of the  $V_{REF}$ , the current of the low-side switch triggers  $I_{LS\_LIMIT}$  for 256 consecutive cycles and hiccup current protection mode is activated. In hiccup mode, the converter shuts down and keeps off for a period of hiccup,  $T_{HICCUP}$  (135ms typical) before the LMR544x tries to start again. If overcurrent or a short-circuit fault condition still exist, hiccup repeats until the fault condition is removed. Hiccup

mode reduces power dissipation under severe overcurrent conditions, preventing overheating and potential damage to the device.

For the FPWM version, the inductor current is allowed to go negative. When this current exceeds the low-side negative current limit,  $I_{LS\_NEG}$ , the low-side switch is turned off and high-side switch is turned on immediately. This is used to protect the low-side switch from excessive negative current.

### **7.3.7 Soft Start**

The integrated soft-start circuit prevents input inrush current impacting the LMR544xx and the input power supply. Soft start is achieved by slowly ramping up the internal reference voltage when the device is first enabled or powered up. The typical soft-start time is 1.8ms.

The LMR544xx also employs overcurrent protection blanking time,  $T_{OCP\_BLK}$  (33ms typical), at the beginning of power up. Without this feature, in applications with a large amount of output capacitors and high  $V_{OUT}$ , the inrush current is large enough to trigger the current-limit protection, which can cause a false start as the device enters into hiccup mode. This results in a continuous recycling of soft start without raising up to the programmed output voltage. The LMR544xx is able to charge the output capacitor to the programmed  $V_{OUT}$  by controlling the average inductor current during the start-up sequence in the blanking time,  $T_{OCP\_BLK}$ .

### **7.3.8 Thermal Shutdown**

The LMR544xx provides an internal thermal shutdown to protect the device when the junction temperature exceeds 170°C. Both high-side and low-side FETs stop switching in thermal shutdown. After the die temperature falls below 158°C, the device reinitiates the power-up sequence controlled by the internal soft-start circuitry.

## 7.4 Device Functional Modes

### 7.4.1 Shutdown Mode

The EN pin provides electrical ON/OFF control for the LMR544xx. When  $V_{EN}$  is below 0.95V, the device is in shutdown mode. The LMR544xx also employs  $V_{IN}$  undervoltage lockout protection (UVLO). If  $V_{IN}$  voltage is below its UVLO threshold of 3.25V, the converter is turned off.

### 7.4.2 Active Mode

The LMR544xx is in active mode when both  $V_{EN}$  and  $V_{IN}$  are above their respective operating threshold. The simplest way to enable the LMR544xx is to connect the EN pin to VIN pin. This allows self-start-up when the input voltage is in the operating range of 4.0V to 36V. See [Section 7.3.3](#) for details on setting these operating levels.

In active mode, depending on the load current, the LMR544xx is in one of four modes:

1. Continuous conduction mode (CCM) with fixed switching frequency when load current is greater than half of the peak-to-peak inductor current ripple (for both PFM and FPWM versions)
2. Discontinuous conduction mode (DCM) with fixed switching frequency when load current is less than half of the peak-to-peak inductor current ripple(only for PFM version)
3. Pulse frequency modulation mode (PFM) when switching frequency is decreased at very light load (only for PFM version)
4. Forced pulse width modulation mode (FPWM) with fixed switching frequency even at light load (only for FPWM version)

### 7.4.3 CCM Mode

Continuous conduction mode (CCM) operation is employed in the LMR544xx when the load current is greater than half of the peak-to-peak inductor current. In CCM operation, the frequency of operation is fixed, output voltage ripple is at a minimum in this mode and the maximum output current of 1A or 0.6A can be supplied by the LMR54410 or LMR54406, respectively.

### 7.4.4 Light Load Operation (PFM Version)

For PFM version, when the load current is lower than half of the peak-to-peak inductor current in CCM, the LMR544xx operates in discontinuous conduction mode (DCM), also known as diode emulation mode (DEM). In DCM operation, the low-side switch is turned off when the inductor current drops to  $I_{LS\_ZC}$  (20mA typical) to improve efficiency. Both switching losses and conduction losses are reduced in DCM, compared to forced PWM operation at light load.

During light load operation, pulse frequency modulation (PFM) mode is activated to maintain high efficiency operation. When either the minimum high-side switch ON time  $t_{ON\_MIN}$  or the minimum peak inductor current  $I_{PEAK\_MIN}$  (300mA typical) is reached, the switching frequency decreases to maintain regulation. In PFM mode, switching frequency is decreased by the control loop to maintain output voltage regulation when load current reduces. Switching loss is further reduced in PFM operation due to a significant drop in effective switching frequency.

### 7.4.5 Light-Load Operation (FPWM Version)

For FPWM version, LMR544xx is locked in PWM mode at full load range. This operation is maintained, even in no-load condition, by allowing the inductor current to reverse its normal direction. This mode trades off reduced light load efficiency for low output voltage ripple, tight output voltage regulation, and constant switching frequency.

## 8 Application and Implementation

### Note

Information in the following applications sections is not part of the TI component specification, and TI does not warrant its accuracy or completeness. TI's customers are responsible for determining suitability of components for their purposes, as well as validating and testing their design implementation to confirm system functionality.

### 8.1 Application Information

The LMR544xx is a step-down DC-to-DC converter. The LMR54410 is typically used to convert a higher input voltage to a lower output DC voltage with a maximum output current of 1A. The LMR54406 is typically used to convert a higher input voltage to a lower output DC voltage with a maximum output current of 0.6A. The following design procedure can be used to select components for the LMR544xx.

### 8.2 Typical Application

The LMR54410 only requires a few external components to convert from a wide voltage range supply to a fixed output voltage. [Figure 8-1](#) shows a basic schematic.

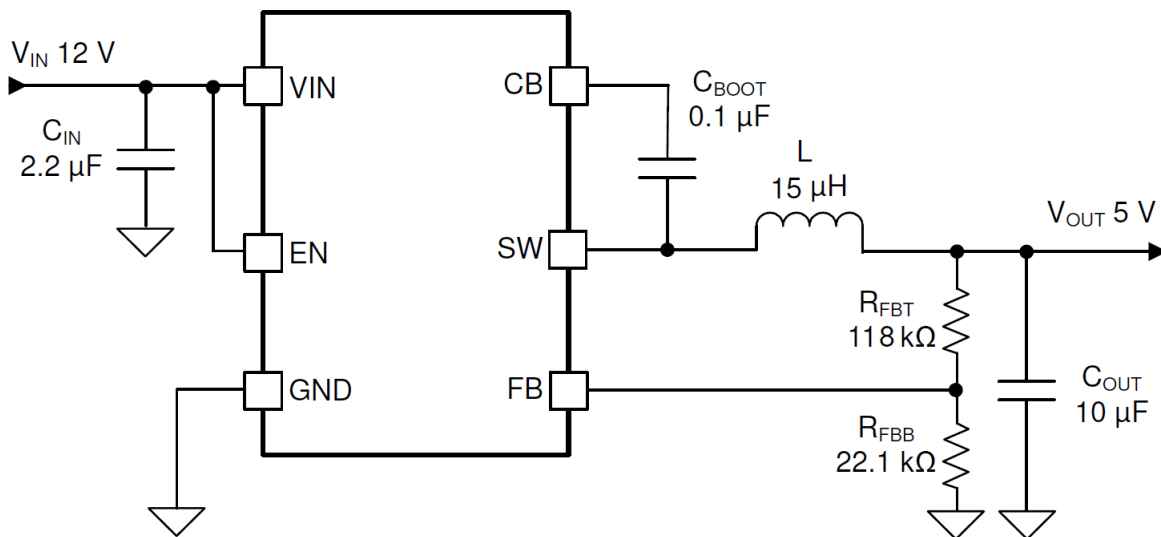

**Figure 8-1. Application Circuit**

The external components have to fulfill the needs of the application and the stability criteria of the control loop of the device. [Table 8-1](#) can be used to simplify the output filter component selection.

**Table 8-1. L and C<sub>OUT</sub> Typical Values**

f <sub>sw</sub> (kHz)	V <sub>OUT</sub> (V)	L (μH)	C <sub>OUT</sub> (μF) <sup>(1)</sup>	R <sub>FBT</sub> (kΩ)	R <sub>FBB</sub> (kΩ)
1100	3.3	10	22μF / 10V	69.8	22.1
	5	15	22μF / 10V	118	22.1
	12	33	22μF / 25V + 10μF / 25V	309	22.1

(1) A ceramic capacitor is used in this table.

### 8.2.1 Design Requirements

The detailed design procedure is described based on a design example. For this design example, use the parameters listed in [Table 8-2](#) as the input parameters.

**Table 8-2. Design Example Parameters**

PARAMETER	VALUE
Input voltage, $V_{IN}$	5V typical, range from 6V to 36V
Output voltage, $V_{OUT}$	5V $\pm$ 3%
Maximum output current, $I_{OUT\_MAX}$	1A
Output overshoot/undershoot (0A to 1A)	5%
Output voltage ripple	0.5%
Operating frequency	1100kHz

### 8.2.2 Detailed Design Procedure

#### 8.2.2.1 Output Voltage Set-Point

The output voltage of the LMR54410 device is externally adjustable using a resistor divider network. The divider network is comprised of a top feedback resistor  $R_{FBT}$  and bottom feedback resistor  $R_{FBB}$ . [Equation 7](#) is used to determine the output voltage of the converter:

$$R_{FBT} = \frac{V_{OUT} - V_{REF}}{V_{REF}} \times R_{FBB} \quad (7)$$

Choose the value of  $R_{FBB}$  to be 22.1k $\Omega$ . With the desired output voltage set to 5V and the  $V_{REF} = 0.8V$ , the  $R_{FBT}$  value can then be calculated using [Equation 7](#). The formula yields to a value 116k $\Omega$ , a standard value of 118k $\Omega$  is selected.

#### 8.2.2.2 Switching Frequency

The higher switching frequency allows for lower value inductors and smaller output capacitors, which results in smaller design size and lower component cost. However, higher switching frequency brings more switching loss, making the design less efficient and produce more heat. The switching frequency is also limited by the minimum on time of the integrated power switch, the input voltage, the output voltage, and the frequency shift limitation as mentioned in [Section 7.3.4](#). For this example, a switching frequency of 1100kHz is selected.

#### 8.2.2.3 Inductor Selection

The most critical parameters for the inductor are the inductance, saturation current, and the RMS current. The inductance is based on the desired peak-to-peak ripple current  $\Delta i_L$ . Because the ripple current increases with the input voltage, the maximum input voltage is always used to calculate the minimum inductance  $L_{MIN}$ . Use [Equation 9](#) to calculate the minimum value of the output inductor.  $K_{IND}$  is a coefficient that represents the amount of inductor ripple current relative to the maximum output current of the device. A reasonable value of  $K_{IND}$  must be 20% to 60% of maximum  $I_{OUT}$  supported by converter. During an instantaneous overcurrent operation event, the RMS and peak inductor current can be high. The inductor saturation current must be higher than peak current limit level.

$$\Delta i_L = \frac{V_{OUT} \times (V_{IN\_MAX} - V_{OUT})}{V_{IN\_MAX} \times L \times f_{SW}} \quad (8)$$

$$L_{MIN} = \frac{V_{IN\_MAX} - V_{OUT}}{I_{OUT} \times K_{IND}} \times \frac{V_{OUT}}{V_{IN\_MAX} \times f_{SW}} \quad (9)$$

In general, it is preferable to choose lower inductance in switching power supplies, because it usually corresponds to faster transient response, smaller DCR, and reduced size for more compact designs. Too low of an inductance can generate too large of an inductor current ripple such that overcurrent protection at the

full load can be falsely triggered. It also generates more inductor core loss because the current ripple is larger. Larger inductor current ripple also implies larger output voltage ripple with the same output capacitors. With peak current mode control, TI recommends to have adequate amount of inductor ripple current. A larger inductor ripple current improves the comparator signal-to-noise ratio.

For this design example, choose  $K_{IND} = 0.4$ ,  $I_{OUT} = 1A$ . The minimum inductor value is calculated to be 9.8- $\mu H$ . Choose the nearest standard 10- $\mu H$  ferrite inductor with a capability of 1.5A RMS current and 2.5A saturation current.

#### 8.2.2.4 Output Capacitor Selection

The device is designed to be used with a wide variety of LC filters. Minimizing the output capacitance to keep cost and size down is generally desired. The output capacitor or capacitors,  $C_{OUT}$ , must be chosen with care because it directly affects the steady state output voltage ripple, loop stability, and output voltage overshoot and undershoot during load current transient. The output voltage ripple is essentially composed of two parts. One part is caused by the inductor ripple current flowing through the Equivalent Series Resistance (ESR) of the output capacitors:

$$\Delta V_{OUT\_ESR} = \Delta i_L \times ESR = K_{IND} \times I_{OUT} \times ESR \quad (10)$$

The other part is caused by the inductor current ripple charging and discharging the output capacitors:

$$\Delta V_{OUT\_C} = \frac{\Delta i_L}{8 \times f_{SW} \times C_{OUT}} = \frac{K_{IND} \times I_{OUT}}{8 \times f_{SW} \times C_{OUT}} \quad (11)$$

The two components of the voltage ripple are not in-phase, therefore, the actual peak-to-peak ripple is less than the sum of the two peaks.

Output capacitance is usually limited by transient performance specifications if the system requires tight voltage regulation with presence of large current steps and fast slew rates. When a large load step occurs, output capacitors provide the required charge before the inductor current can slew to an appropriate level. The control loop of the converter usually requires eight or more clock cycles to regulate the inductor current equal to the new load level during this time. The output capacitance must be large enough to supply the current difference for eight clock cycles to maintain the output voltage within the specified range. Equation 12 shows the minimum output capacitance needed for a specified  $V_{OUT}$  overshoot and undershoot.

$$C_{OUT} > \frac{1}{2} \times \frac{8 \times (I_{OH} - I_{OL})}{f_{SW} \times \Delta V_{OUT\_SHOOT}} \quad (12)$$

where

- $K_{IND}$  = Ripple ratio of the inductor current ( $\Delta i_L / I_{OUT}$ )
- $I_{OL}$  = Low level output current during load transient
- $I_{OH}$  = High level output current during load transient
- $V_{OUT\_SHOOT}$  = Target output voltage overshoot or undershoot

For this design example, the target output ripple is 30mV. Assuming  $\Delta V_{OUT\_ESR} = \Delta V_{OUT\_C} = 30mV$ , choose  $K_{IND} = 0.4$ . Equation 10 yields ESR no larger than 75m $\Omega$  and Equation 11 yields  $C_{OUT}$  no smaller than 2.38 $\mu F$ . For the target overshoot and undershoot limitation of this design,  $\Delta V_{OUT\_SHOOT} = 8\% \times V_{OUT} = 400mV$ . The  $C_{OUT}$  can be calculated to be no less than 14.3 $\mu F$  by Equation 12. In summary, the most stringent criteria for the output capacitor is 14.3 $\mu F$ . Considering derating, one 22- $\mu F$ , 16V, X7R ceramic capacitor with 10m $\Omega$  ESR is used.

### 8.2.2.5 Input Capacitor Selection

The LMR54410 device requires a high frequency input decoupling capacitor or capacitor. The typical recommended value for the high frequency decoupling capacitor is 2.2μF or higher. A high-quality ceramic type X5R or X7R with sufficiency voltage rating is recommended. The voltage rating must be greater than the maximum input voltage. To compensate the derating of ceramic capacitors, a voltage rating of twice the maximum input voltage is recommended. For this design, one 2.2μF, X7R dielectric capacitor rated for 50V is used for the input decoupling capacitor. The equivalent series resistance (ESR) is approximately 10mΩ, and the current rating is 1A. Include a capacitor with a value of 0.1μF for high-frequency filtering and place it as close as possible to the device pins.

### 8.2.2.6 Bootstrap Capacitor

Every LMR54410 design requires a bootstrap capacitor, C<sub>BOOT</sub>. The recommended bootstrap capacitor is 0.1μF and rated at 16V or higher. The bootstrap capacitor is located between the SW pin and the CB pin. The bootstrap capacitor must be a high-quality ceramic type with X7R or X5R grade dielectric for temperature stability.

### 8.2.2.7 Undervoltage Lockout Set-Point

The system undervoltage lockout (UVLO) is adjusted using the external voltage divider network of R<sub>ENT</sub> and R<sub>ENB</sub>. The UVLO has two thresholds, one for power up when the input voltage is rising and one for power down or brown outs when the input voltage is falling. [Equation 13](#) can be used to determine the V<sub>IN</sub> UVLO level.

$$V_{IN\_RISING} = V_{ENH} \times \frac{R_{ENT} + R_{ENB}}{R_{ENB}} \quad (13)$$

The EN rising threshold (V<sub>ENH</sub>) for LMR54410 is set to be 1.23V (typical). Choose a value of 200kΩ for R<sub>ENB</sub> to minimize input current from the supply. If the desired V<sub>IN</sub> UVLO level is at 6.0V, then the value of R<sub>ENT</sub> can be calculated using [Equation 14](#):

$$R_{ENT} = \left( \frac{V_{IN\_RISING}}{V_{ENH}} - 1 \right) \times R_{ENB} \quad (14)$$

The above equation yields a value of 775.6kΩ, a standard value of 768kΩ is selected. The resulting falling UVLO threshold, equal to 5.3V, can be calculated by [Equation 15](#) where EN hysteresis voltage, V<sub>EN\_HYS</sub>, is 0.13V (typical).

$$V_{IN\_FALLING} = (V_{ENH} - V_{EN\_HYS}) \times \frac{R_{ENT} + R_{ENB}}{R_{ENB}} \quad (15)$$

### 8.2.2.8 Replacing Non Sync Converter

The LMR54410 can also be used to replace asynchronous converters, which need a rectifying diode in the application circuit. The design works fine with or without a rectifying diode connected to the switch node of the LMR54410 as shown in [Figure 8-2](#).

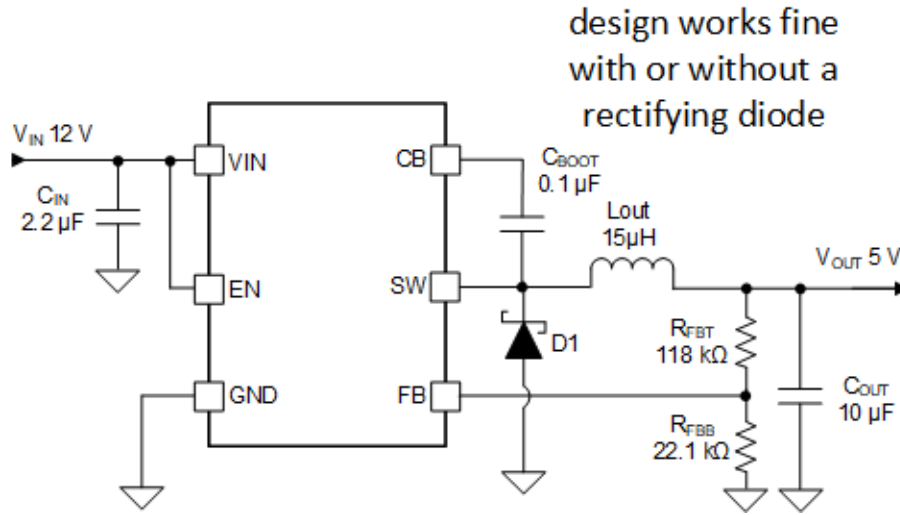

**Figure 8-2. Replacing Non Sync Converter**

### 8.2.3 Application Curves

Unless otherwise specified the following conditions apply:  $V_{IN} = 12V$ ,  $V_{OUT} = 5V$ ,  $f_{SW} = 1100kHz$ ,  $L = 15\mu H$ ,  $C_{OUT} = 22\mu F$ ,  $T_A = 25^\circ C$ .

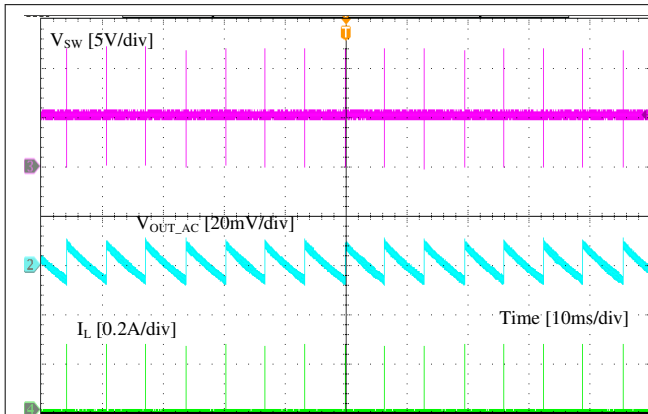

Figure 8-3. Ripple at No Load

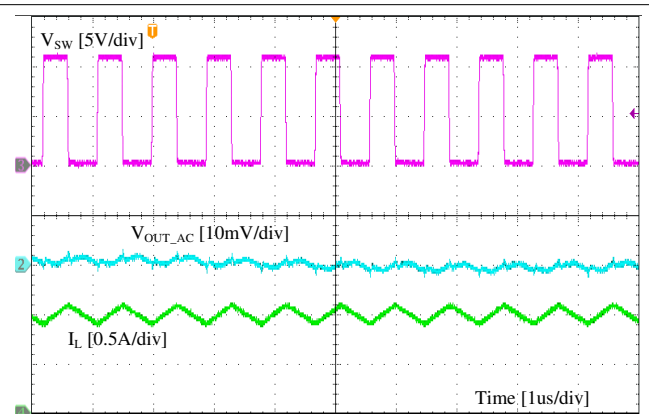

Figure 8-4. Ripple at Full Load

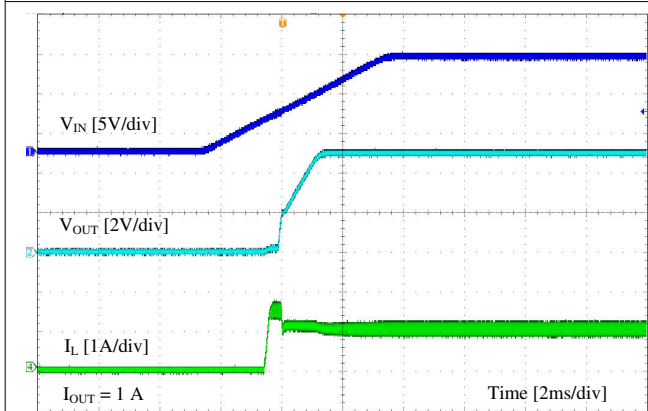

Figure 8-5. Start-Up by  $V_{IN}$

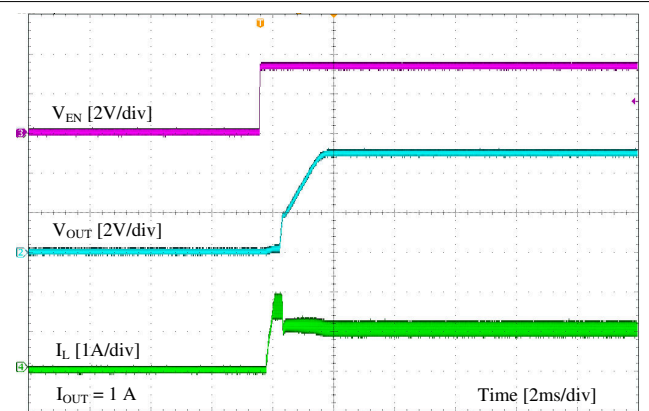

Figure 8-6. Start-Up by EN

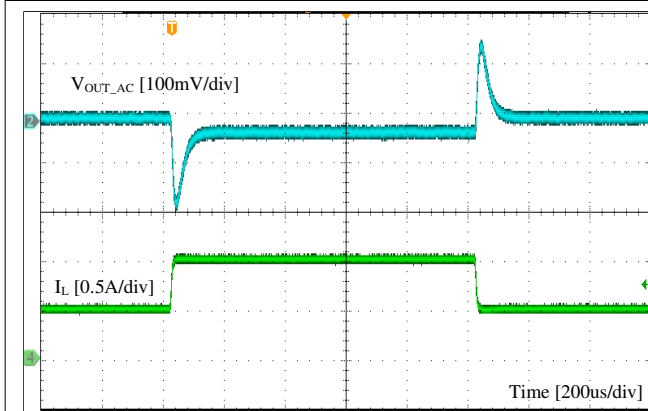

Figure 8-7. Load Transient

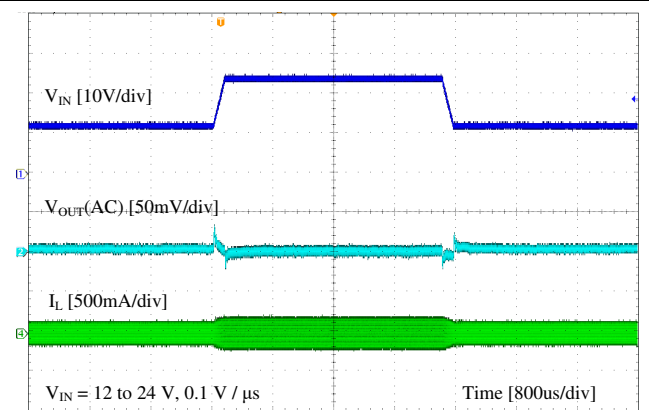
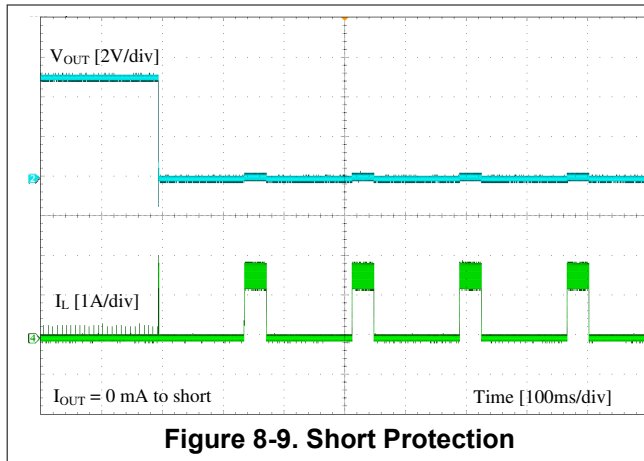
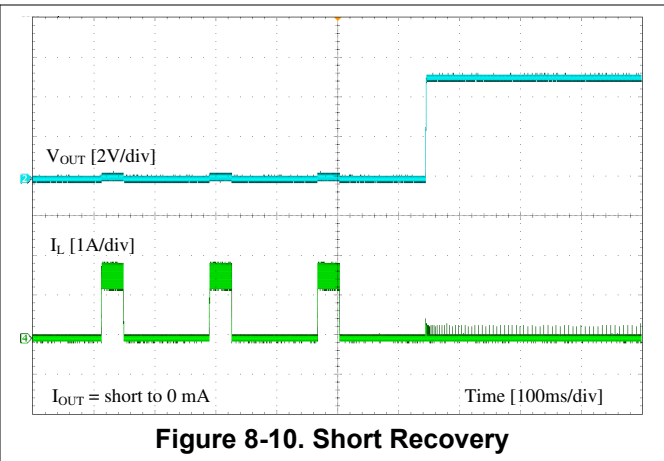

Figure 8-8. Line Transient



**Figure 8-9. Short Protection**



**Figure 8-10. Short Recovery**

## 8.3 Power Supply Recommendations

The LMR544xx is designed to operate from an input voltage supply range between 4.0V and 36V. This input supply must be well-regulated and able to withstand maximum input current and maintain a stable voltage. The resistance of the input supply rail must be low enough that an input current transient does not cause a high enough drop at the LMR544xx supply voltage that can cause a false UVLO fault triggering and system reset. If the input supply is located more than a few inches from the LMR544xx additional bulk capacitance can be required in addition to the ceramic bypass capacitors. The amount of bulk capacitance is not critical, but a 10 $\mu$ F or 22 $\mu$ F electrolytic capacitor is a typical choice.

## 8.4 Layout

### 8.4.1 Layout Guidelines

Layout is a critical portion of good power supply design. The following guidelines help users design a PCB with the best power conversion performance, thermal performance, and minimized generation of unwanted EMI.

- Place the input bypass capacitor  $C_{IN}$  as close as possible to the VIN and GND pins. Grounding for both the input and output capacitors must consist of localized top side planes that connect to the GND pin.
- Minimize trace length to the FB pin net. Both feedback resistors,  $R_{FBT}$  and  $R_{FBB}$ , must be located close to the FB pin. If  $V_{OUT}$  accuracy at the load is important, make sure  $V_{OUT}$  sense is made at the load. Route  $V_{OUT}$  sense path away from noisy nodes and preferably through a layer on the other side of a shielded layer.
- Use ground plane in one of the middle layers as noise shielding and heat dissipation path if possible.
- Make  $V_{IN}$ ,  $V_{OUT}$ , and ground bus connections as wide as possible. This action reduces any voltage drops on the input or output paths of the converter and maximizes efficiency.
- Provide adequate device heat-sinking. GND, VIN, and SW pins provide the main heat dissipation path, make the GND, VIN, and SW plane area as large as possible. Use an array of heat-sinking vias to connect the top side ground plane to the ground plane on the bottom PCB layer. If the PCB has multiple copper layers, these thermal vias can also be connected to inner layer heat-spreading ground planes. Make sure enough copper area is used for heat-sinking to keep the junction temperature below 125°C.

#### 8.4.1.1 Compact Layout for EMI Reduction

Radiated EMI is generated by the high di/dt components in pulsing currents in switching converters. The larger area covered by the path of a pulsing current, the more EMI is generated. High frequency ceramic bypass capacitors at the input side provide primary path for the high di/dt components of the pulsing current. Placing a ceramic bypass capacitor or capacitors as close as possible to the VIN and GND pins is the key to EMI reduction.

The SW pin connecting to the inductor must be as short as possible, and just wide enough to carry the load current without excessive heating. Short, thick traces or copper pours (shapes) must be used for high current conduction path to minimize parasitic resistance. The output capacitors must be placed close to the  $V_{OUT}$  end of the inductor and closely grounded to GND pin.

#### 8.4.1.2 Feedback Resistors

To reduce noise sensitivity of the output voltage feedback path, it is important to place the resistor divider close to the FB pin, rather than close to the load. The FB pin is the input to the error amplifier, so it is a high impedance node and very sensitive to noise. Placing the resistor divider closer to the FB pin reduces the trace length of FB signal and reduces noise coupling. The output node is a low impedance node, so the trace from  $V_{OUT}$  to the resistor divider can be long if short path is not available.

If voltage accuracy at the load is important, make sure voltage sense is made at the load. Doing so corrects for voltage drops along the traces and provides the best output accuracy. The voltage sense trace from the load to the feedback resistor divider must be routed away from the SW node path and the inductor to avoid contaminating the feedback signal with switch noise, while also minimizing the trace length. This is most important when high value resistors are used to set the output voltage. TI recommends to route the voltage sense trace and place the resistor divider on a different layer than the inductor and SW node path, such that there is a ground plane in between the feedback trace and inductor/SW node polygon. This provides further shielding for the voltage feedback path from EMI noises.

### 8.4.2 Layout Example

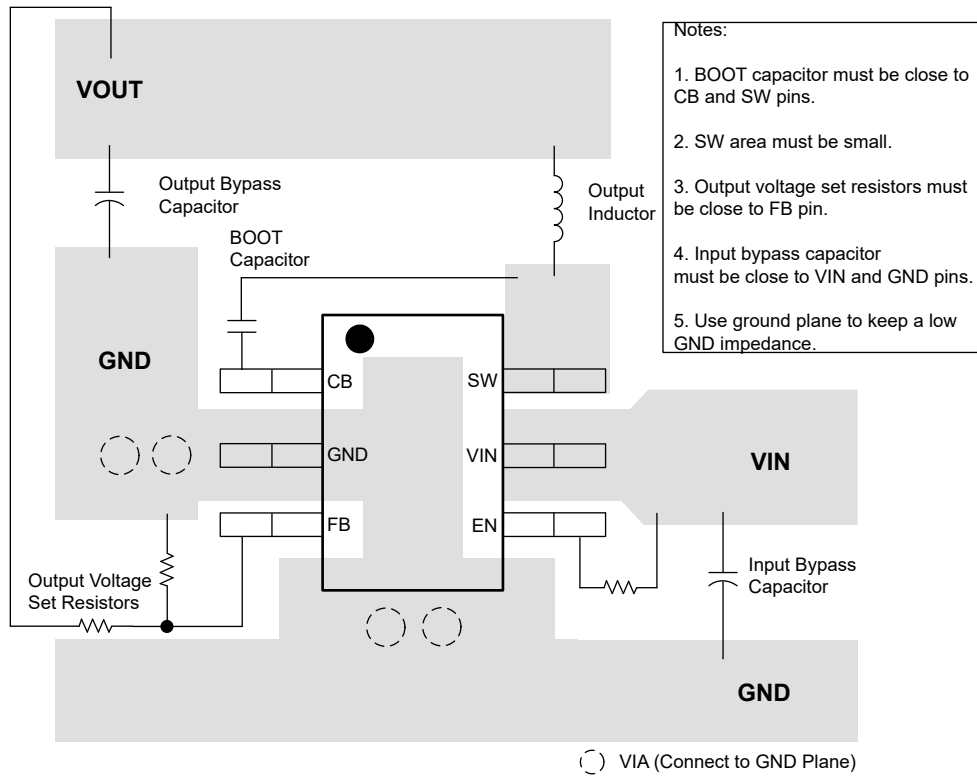

**Figure 8-11. Layout**

## 9 Device and Documentation Support

### 9.1 Device Support

#### 9.1.1 Third-Party Products Disclaimer

TI'S PUBLICATION OF INFORMATION REGARDING THIRD-PARTY PRODUCTS OR SERVICES DOES NOT CONSTITUTE AN ENDORSEMENT REGARDING THE SUITABILITY OF SUCH PRODUCTS OR SERVICES OR A WARRANTY, REPRESENTATION OR ENDORSEMENT OF SUCH PRODUCTS OR SERVICES, EITHER ALONE OR IN COMBINATION WITH ANY TI PRODUCT OR SERVICE.

### 9.2 Documentation Support

#### 9.2.1 Related Documentation

For related documentation see the following:

Texas Instruments, [AN-1149 Layout Guidelines for Switching Power Supplies](#) application report

### 9.3 Receiving Notification of Documentation Updates

To receive notification of documentation updates, navigate to the device product folder on [ti.com](#). Click on *Notifications* to register and receive a weekly digest of any product information that has changed. For change details, review the revision history included in any revised document.

### 9.4 Support Resources

[TI E2E™ support forums](#) are an engineer's go-to source for fast, verified answers and design help — straight from the experts. Search existing answers or ask your own question to get the quick design help you need.

Linked content is provided "AS IS" by the respective contributors. They do not constitute TI specifications and do not necessarily reflect TI's views; see TI's [Terms of Use](#).

### 9.5 Trademarks

TI E2E™ is a trademark of Texas Instruments.

SIMPLE SWITCHER® are registered trademarks of Texas Instruments.

All trademarks are the property of their respective owners.

### 9.6 Electrostatic Discharge Caution



This integrated circuit can be damaged by ESD. Texas Instruments recommends that all integrated circuits be handled with appropriate precautions. Failure to observe proper handling and installation procedures can cause damage.

ESD damage can range from subtle performance degradation to complete device failure. Precision integrated circuits may be more susceptible to damage because very small parametric changes could cause the device not to meet its published specifications.

### 9.7 Glossary

[TI Glossary](#) This glossary lists and explains terms, acronyms, and definitions.

## 10 Revision History

NOTE: Page numbers for previous revisions may differ from page numbers in the current version.

### Changes from Revision D (April 2024) to Revision E (January 2026) Page

- Added spec for SW to GND less than 10ns transients.....4

### Changes from Revision C (February 2024) to Revision D (April 2024) Page

- Changed CDM value from  $\pm 750V$  to  $\pm 1000V$ ..... 4

### Changes from Revision B (February 2022) to Revision C (February 2024) Page

- Changed BODY SIZE to PACKAGE SIZE in the *Device Information* table..... 1
- Updated trademark information..... 1
- Changed [Figure 6-1](#) from 1.1M to 1100K..... 8
- Changed [Figure 6-5](#) and [Figure 6-6](#) position right to left.....8
- Changed [Figure 6-4](#) notes from 2.1Mhz to 1100Khz.....8
- Updated SCH GND connection in [Replacing Non Sync Converter](#) .....22

### Changes from Revision A (November 2021) to Revision B (February 2022) Page

- Changed data sheet title .....1
- Added [Section 8.2.2.8](#) ..... 22

### Changes from Revision \* (October 2021) to Revision A (November 2021) Page

- Changed device status from Advance Information to Production Data..... 1

## 11 Mechanical, Packaging, and Orderable Information

The following pages include mechanical, packaging, and orderable information. This information is the most current data available for the designated devices. This data is subject to change without notice and revision of this document. For browser-based versions of this data sheet, refer to the left-hand navigation.

**PACKAGING INFORMATION**

Orderable part number	Status (1)	Material type (2)	Package   Pins	Package qty   Carrier	RoHS (3)	Lead finish/ Ball material (4)	MSL rating/ Peak reflow (5)	Op temp (°C)	Part marking (6)
<a href="#">LMR54406DBVR</a>	Active	Production	SOT-23 (DBV)   6	3000   LARGE T&R	Yes	NIPDAU   SN	Level-1-260C-UNLIM	-40 to 125	5406
LMR54406DBVR.A	Active	Production	SOT-23 (DBV)   6	3000   LARGE T&R	Yes	NIPDAU	Level-1-260C-UNLIM	-40 to 150	5406
<a href="#">LMR54406FDBVR</a>	Active	Production	SOT-23 (DBV)   6	3000   LARGE T&R	Yes	NIPDAU   SN	Level-1-260C-UNLIM	-40 to 125	546F
LMR54406FDBVR.A	Active	Production	SOT-23 (DBV)   6	3000   LARGE T&R	Yes	NIPDAU	Level-1-260C-UNLIM	-40 to 150	546F
<a href="#">LMR54410DBVR</a>	Active	Production	SOT-23 (DBV)   6	3000   LARGE T&R	Yes	NIPDAU   SN	Level-1-260C-UNLIM	-40 to 125	5410
LMR54410DBVR.A	Active	Production	SOT-23 (DBV)   6	3000   LARGE T&R	Yes	NIPDAU	Level-1-260C-UNLIM	-40 to 150	5410
LMR54410DBVRG4	Active	Production	SOT-23 (DBV)   6	3000   LARGE T&R	Yes	NIPDAU	Level-1-260C-UNLIM	-40 to 150	5410
LMR54410DBVRG4.A	Active	Production	SOT-23 (DBV)   6	3000   LARGE T&R	Yes	NIPDAU	Level-1-260C-UNLIM	-40 to 150	5410
<a href="#">LMR54410FDBVR</a>	Active	Production	SOT-23 (DBV)   6	3000   LARGE T&R	Yes	NIPDAU   SN	Level-1-260C-UNLIM	-40 to 125	541F
LMR54410FDBVR.A	Active	Production	SOT-23 (DBV)   6	3000   LARGE T&R	Yes	NIPDAU	Level-1-260C-UNLIM	-40 to 150	541F

(1) **Status:** For more details on status, see our [product life cycle](#).

(2) **Material type:** When designated, preproduction parts are prototypes/experimental devices, and are not yet approved or released for full production. Testing and final process, including without limitation quality assurance, reliability performance testing, and/or process qualification, may not yet be complete, and this item is subject to further changes or possible discontinuation. If available for ordering, purchases will be subject to an additional waiver at checkout, and are intended for early internal evaluation purposes only. These items are sold without warranties of any kind.

(3) **RoHS values:** Yes, No, RoHS Exempt. See the [TI RoHS Statement](#) for additional information and value definition.

(4) **Lead finish/Ball material:** Parts may have multiple material finish options. Finish options are separated by a vertical ruled line. Lead finish/Ball material values may wrap to two lines if the finish value exceeds the maximum column width.

(5) **MSL rating/Peak reflow:** The moisture sensitivity level ratings and peak solder (reflow) temperatures. In the event that a part has multiple moisture sensitivity ratings, only the lowest level per JEDEC standards is shown. Refer to the shipping label for the actual reflow temperature that will be used to mount the part to the printed circuit board.

(6) **Part marking:** There may be an additional marking, which relates to the logo, the lot trace code information, or the environmental category of the part.

Multiple part markings will be inside parentheses. Only one part marking contained in parentheses and separated by a "~" will appear on a part. If a line is indented then it is a continuation of the previous line and the two combined represent the entire part marking for that device.

**Important Information and Disclaimer:** The information provided on this page represents TI's knowledge and belief as of the date that it is provided. TI bases its knowledge and belief on information provided by third parties, and makes no representation or warranty as to the accuracy of such information. Efforts are underway to better integrate information from third parties. TI has taken and continues to take reasonable steps to provide representative

and accurate information but may not have conducted destructive testing or chemical analysis on incoming materials and chemicals. TI and TI suppliers consider certain information to be proprietary, and thus CAS numbers and other limited information may not be available for release.

In no event shall TI's liability arising out of such information exceed the total purchase price of the TI part(s) at issue in this document sold by TI to Customer on an annual basis.

**TAPE AND REEL INFORMATION**

**QUADRANT ASSIGNMENTS FOR PIN 1 ORIENTATION IN TAPE**

\*All dimensions are nominal

Device	Package Type	Package Drawing	Pins	SPQ	Reel Diameter (mm)	Reel Width W1 (mm)	A0 (mm)	B0 (mm)	K0 (mm)	P1 (mm)	W (mm)	Pin1 Quadrant
LMR54406DBVR	SOT-23	DBV	6	3000	178.0	8.4	3.2	3.2	1.4	4.0	8.0	Q3
LMR54406FDBVR	SOT-23	DBV	6	3000	180.0	8.4	3.2	3.2	1.4	4.0	8.0	Q3
LMR54410DBVR	SOT-23	DBV	6	3000	178.0	8.4	3.2	3.2	1.4	4.0	8.0	Q3
LMR54410DBVRG4	SOT-23	DBV	6	3000	180.0	8.4	3.2	3.2	1.4	4.0	8.0	Q3
LMR54410FDBVR	SOT-23	DBV	6	3000	180.0	8.4	3.2	3.2	1.4	4.0	8.0	Q3

## TAPE AND REEL BOX DIMENSIONS



\*All dimensions are nominal

Device	Package Type	Package Drawing	Pins	SPQ	Length (mm)	Width (mm)	Height (mm)
LMR54406DBVR	SOT-23	DBV	6	3000	208.0	191.0	35.0
LMR54406FDBVR	SOT-23	DBV	6	3000	210.0	185.0	35.0
LMR54410DBVR	SOT-23	DBV	6	3000	208.0	191.0	35.0
LMR54410DBVRG4	SOT-23	DBV	6	3000	210.0	185.0	35.0
LMR54410FDBVR	SOT-23	DBV	6	3000	210.0	185.0	35.0



# EXAMPLE BOARD LAYOUT

DBV0006A

SOT-23 - 1.45 mm max height

SMALL OUTLINE TRANSISTOR



LAND PATTERN EXAMPLE  
EXPOSED METAL SHOWN  
SCALE:15X

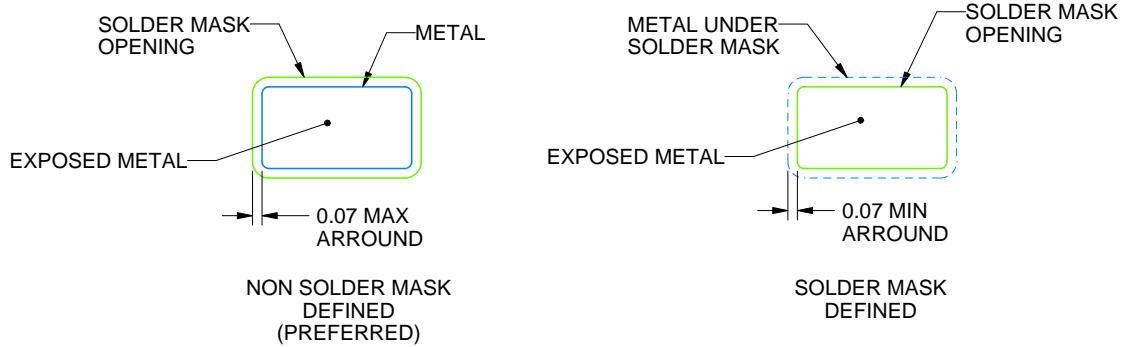

SOLDER MASK DETAILS

4214840/G 08/2024

NOTES: (continued)

6. Publication IPC-7351 may have alternate designs.
7. Solder mask tolerances between and around signal pads can vary based on board fabrication site.

# EXAMPLE STENCIL DESIGN

DBV0006A

SOT-23 - 1.45 mm max height

SMALL OUTLINE TRANSISTOR



SOLDER PASTE EXAMPLE  
BASED ON 0.125 mm THICK STENCIL  
SCALE:15X

4214840/G 08/2024

NOTES: (continued)

8. Laser cutting apertures with trapezoidal walls and rounded corners may offer better paste release. IPC-7525 may have alternate design recommendations.
9. Board assembly site may have different recommendations for stencil design.

## IMPORTANT NOTICE AND DISCLAIMER

TI PROVIDES TECHNICAL AND RELIABILITY DATA (INCLUDING DATASHEETS), DESIGN RESOURCES (INCLUDING REFERENCE DESIGNS), APPLICATION OR OTHER DESIGN ADVICE, WEB TOOLS, SAFETY INFORMATION, AND OTHER RESOURCES "AS IS" AND WITH ALL FAULTS, AND DISCLAIMS ALL WARRANTIES, EXPRESS AND IMPLIED, INCLUDING WITHOUT LIMITATION ANY IMPLIED WARRANTIES OF MERCHANTABILITY, FITNESS FOR A PARTICULAR PURPOSE OR NON-INFRINGEMENT OF THIRD PARTY INTELLECTUAL PROPERTY RIGHTS.

These resources are intended for skilled developers designing with TI products. You are solely responsible for (1) selecting the appropriate TI products for your application, (2) designing, validating and testing your application, and (3) ensuring your application meets applicable standards, and any other safety, security, regulatory or other requirements.

These resources are subject to change without notice. TI grants you permission to use these resources only for development of an application that uses the TI products described in the resource. Other reproduction and display of these resources is prohibited. No license is granted to any other TI intellectual property right or to any third party intellectual property right. TI disclaims responsibility for, and you fully indemnify TI and its representatives against any claims, damages, costs, losses, and liabilities arising out of your use of these resources.

TI's products are provided subject to [TI's Terms of Sale](#), [TI's General Quality Guidelines](#), or other applicable terms available either on [ti.com](#) or provided in conjunction with such TI products. TI's provision of these resources does not expand or otherwise alter TI's applicable warranties or warranty disclaimers for TI products. Unless TI explicitly designates a product as custom or customer-specified, TI products are standard, catalog, general purpose devices.

TI objects to and rejects any additional or different terms you may propose.

Copyright © 2026, Texas Instruments Incorporated

Last updated 10/2025