

LMH6609 900MHz Voltage Feedback Op Amp

Check for Samples: [LMH6609](#)

FEATURES

- 900MHz –3dB bandwidth ($A_V = 1$)
- Large signal bandwidth and slew rate 100% tested
- 280MHz –3dB bandwidth ($A_V = +2$, $V_{OUT} = 2V_{PP}$)
- 90mA linear output current
- 1400V/ μ s slew rate
- Unity gain stable
- <1mV input Offset voltage
- 7mA Supply current (no load)
- 6.6V to 12V supply voltage range
- 0.01%/0.026° differential gain/phase PAL
- 3.1nV $\sqrt{\text{Hz}}$ voltage noise
- Improved replacement for CLC440, CL420, CL426

APPLICATIONS

- Test equipment
- IF/RF amplifier
- A/D Input driver
- Active filter
- Integrator
- DAC output buffer
- TI's Transimpedance amplifier

DESCRIPTION

The LMH6609 is an ultra wideband, unity gain stable, low power, voltage feedback op amp that offers 900MHz bandwidth at a gain of 1, 1400V/ μ s slew rate and 90mA of linear output current.

The LMH6609 is designed with voltage feedback architecture for maximum flexibility especially for active filters and integrators. The LMH6609 has balanced, symmetrical inputs with well-matched bias currents and minimal offset voltage.

With Differential Gain of 0.01% and Differential Phase of 0.026° the LMH6609 is suited for video applications. The 90mA of linear output current makes the LMH6609 suitable for multiple video loads and cable driving applications as well.

The supply voltage is specified at 6.6V and 10V. A low supply current of 7mA (at 10V supply) makes the LMH6609 useful in a wide variety of platforms, including portable or remote equipment that must run from battery power.

The LMH6609 is available in the industry standard 8-pin SOIC package and in the space-saving 5-pin SOT-23 package. The LMH6609 is specified for operation over the -40°C to +85°C temperature range. The LMH6609 is manufactured in state-of-the-art VIP10™ technology for high performance.

Typical Application

$$K = 1 + \frac{R_F}{R_G} \quad Q = \frac{m}{1 + m^2(2 - K)} \quad \omega_0 = \frac{1}{mRC}$$

Q, K ARE UNITLESS.
 ω_0 IS RELATED TO BANDWIDTH AND IS IN UNITS OF RADIANS/SEC. DIVIDE ω_0 BY 2π TO GET IT IN Hz.
REFER TO OA-26 FOR MORE INFORMATION.

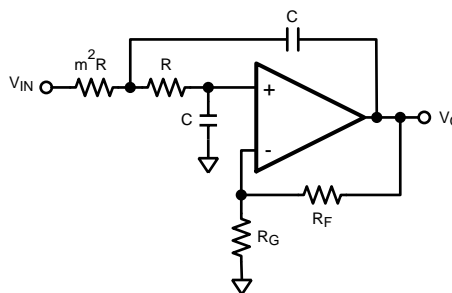

Figure 1. Sallen Key Low Pass Filter with Equal C Value



Please be aware that an important notice concerning availability, standard warranty, and use in critical applications of Texas Instruments semiconductor products and disclaimers thereto appears at the end of this data sheet.

VIP10 is a trademark of Texas Instruments.

All other trademarks are the property of their respective owners.



These devices have limited built-in ESD protection. The leads should be shorted together or the device placed in conductive foam during storage or handling to prevent electrostatic damage to the MOS gates.

Absolute Maximum Ratings ⁽¹⁾

$V_S (V^+ - V^-)$	±6.6V
I_{OUT}	⁽²⁾
Common Mode Input Voltage	V+ to V-
Maximum Junction Temperature	+150°C
Storage Temperature Range	-65°C to +150°C
Lead Temperature Range	+300°C
ESD Tolerance ⁽³⁾	
Human Body Model	2000V
Machine Model	200V

- (1) Absolute Maximum Ratings indicate limits beyond which damage to the device may occur. Operating Ratings indicate conditions for which the device is intended to be functional. For specifications, see the Electrical Characteristics tables.
- (2) The maximum output current (I_{OUT}) is determined by device power dissipation limitations. See the Power Dissipation section of the Application Section for more details.
- (3) Human body model, 1.5kΩ in series with 100pF. Machine model, 0Ω in series with 200pF.

Operating Ratings ⁽¹⁾

Thermal Resistance	Package	(θ_{JC})	(θ_{JA})
	8-Pin SOIC	65°C/W	145°C/W
	5-Pin SOT23	120°C/W	187°C/W
Operating Temperature		-40°C	+85°C
Nominal Supply Voltage ⁽²⁾		±3.3V	±6V

- (1) The maximum output current (I_{OUT}) is determined by device power dissipation limitations. See the Power Dissipation section of the Application Section for more details.
- (2) Nominal Supply voltage range is for supplies with regulation of 10% or better.

±5V Electrical Characteristics

Unless specified, $A_V = +2$, $R_F = 250\Omega$; $V_S = \pm 5V$, $R_L = 100\Omega$; unless otherwise specified. **Boldface** limits apply over temperature Range. ⁽¹⁾

Symbol	Parameter	Conditions	Min	Typ	Max	Units
Frequency Domain Response						
SSBW	-3dB Bandwidth	$V_{OUT} = 0.5V_{PP}$		260		MHz
LSBW	-3dB Bandwidth	$V_{OUT} = 4.0V_{PP}$	150	170		MHz
SSBWG1	-3dB Bandwidth $A_V = 1$	$V_{OUT} = 0.25V_{PP}$		900		MHz
GFP	.1dB Bandwidth	Gain is Flat to .1dB		130		MHz
DG	Differential Gain	$R_L = 150\Omega$, 4.43MHz		0.01		%
DP	Differential Phase	$R_L = 150\Omega$, 4.43MHz		0.026		deg
Time Domain Response						
TRS	Rise and Fall Time	1V Step		1.6		ns
TRL		4V Step		2.6		ns
t_s	Settling Time to 0.05%	2V Step		15		ns
SR	Slew Rate	4V Step ⁽²⁾	1200	1400		V/μs

- (1) Electrical Table values apply only for factory testing conditions at the temperature indicated. Factory testing conditions result in very limited self-heating of the device such that $T_J = T_A$. No specification of parametric performance is indicated in the electrical tables under conditions of internal self heating where $T_J > T_A$. See Applications Section for information on temperature derating of this device. Min/Max ratings are based on product characterization and simulation. Individual parameters are tested as noted.
- (2) Slew rate is Average of Rising and Falling 40-60% slew rates.

±5V Electrical Characteristics (continued)

Unless specified, $A_V = +2$, $R_F = 250\Omega$; $V_S = \pm 5V$, $R_L = 100\Omega$; unless otherwise specified. **Boldface** limits apply over temperature range. ⁽¹⁾

Symbol	Parameter	Conditions	Min	Typ	Max	Units
Distortion and Noise Response						
HD2	2 nd Harmonic Distortion	2V _{PP} , 20MHz		-63		dBc
HD3	3 rd Harmonic Distortion	2V _{PP} , 20MHz		-57		dBc
	Equivalent Input Noise					
VN	Voltage Noise	>1MHz		3.1		nV/√Hz
CN	Current Noise	>1MHz		1.6		pA/√Hz
Static, DC Performance						
V _{IO}	Input Offset Voltage			±0.8	±2.5 ±3.5	mV
	Input Voltage Temperature Drift			4		μV/°C
I _{BN}	Input Bias Current			-2	±5 ±8	μA
	Bias Current Temperature Drift			11		nA/°C
I _{BI}	Input Offset Current			0.1	±1.5 ±3	μA
PSRR	Power Supply Rejection Ratio	DC, 1V Step	67 65	73		dB
CMRR	Common Mode Rejection Ratio	DC, 2V Step	67 65	73		dB
I _{CC}	Supply Current	R _L = ∞		7.0	7.8 8.5	mA
Miscellaneous Performance						
R _{IN}	Input Resistance			1		MΩ
C _{IN}	Input Capacitance			1.2		pF
R _{OUT}	Output Resistance	Closed Loop		0.3		Ω
V _O	Output Voltage Range	R _L = ∞	±3.6 ±3.3	±3.9		V
V _{OL}		R _L = 100Ω	±3.2 ±3.0	±3.5		V
CMIR	Input Voltage Range	Common Mode, CMRR > 60dB	±2.8 ±2.5	±3.0		V
I _O	Linear Output Current	V _{OUT}	±60 ±50	±90		mA

±3.3V Electrical Characteristics

Unless specified, $A_V = +2$, $R_F = 250\Omega$; $V_S = \pm 3.3V$, $R_L = 100\Omega$; unless otherwise specified. **Boldface** limits apply over temperature range. ⁽¹⁾

Symbol	Parameter	Conditions	Min	Typ	Max	Units
Frequency Domain Response						
SSBW	-3dB Bandwidth	$V_{OUT} = 0.5V_{PP}$		180		MHz
LSBW	-3dB Bandwidth	$V_{OUT} = 3.0V_{PP}$		110		MHz
SSBWG1	-3dB Bandwidth $A_V = 1$	$V_{OUT} = 0.25V_{PP}$		450		MHz
GFP	.1dB Bandwidth	$V_{OUT} = 1V_{PP}$		40		MHz
DG	Differential Gain	$R_L = 150\Omega$, 4.43MHz		.01		%
DP	Differential Phase	$R_L = 150\Omega$, 4.43MHz		.06		deg
Time Domain Response						
TRL		1V Step		2.2		ns
SR	Slew Rate	2V Step ⁽²⁾		800		V/ μ s
Distortion and Noise Response						
HD2	2 nd Harmonic Distortion	2V _{PP} , 20MHz		-63		dBc
HD3	3 rd Harmonic Distortion	2V _{PP} , 20MHz		-43		dBc
	Equivalent Input Noise					
VN	Voltage Noise	>1MHz		3.7		nV/ $\sqrt{\text{Hz}}$
CN	Current Noise	>1MHz		1.1		pA/ $\sqrt{\text{Hz}}$
Static, DC Performance						
V_{IO}	Input Offset Voltage			0.8	± 2.5 ± 3.5	mV
I_{BN}	Input Bias Current			-1	± 3 ± 6	μ A
I_{BI}	Input Offset Current			0	± 1.5 ± 3	μ A
PSRR	Power Supply Rejection Ratio	DC, .5V Step	67	73		dB
CMRR	Common Mode Rejection Ratio	DC, 1V Step	67	75		dB
I_{CC}	Supply Current	$R_L = \infty$		3.6	5 6	mA
Miscellaneous Performance						
R_{OUT}	Input Resistance	Close Loop		.05		Ω
V_O	Output Voltage Range	$R_L = \infty$	± 2.1	± 2.3		V
V_{OL}		$R_L = 100\Omega$	± 1.9	± 2.0		V
CMIR	Input Voltage Range	Common Mode		± 1.3		V
I_O	Linear Output Current	V_{OUT}	± 30	± 45		mA

(1) Electrical Table values apply only for factory testing conditions at the temperature indicated. Factory testing conditions result in very limited self-heating of the device such that $T_J = T_A$. No specification of parametric performance is indicated in the electrical tables under conditions of internal self heating where $T_J > T_A$. See Applications Section for information on temperature derating of this device. Min/Max ratings are based on product characterization and simulation. Individual parameters are tested as noted.

(2) Slew rate is Average of Rising and Falling 40-60% slew rates.

CONNECTION DIAGRAM

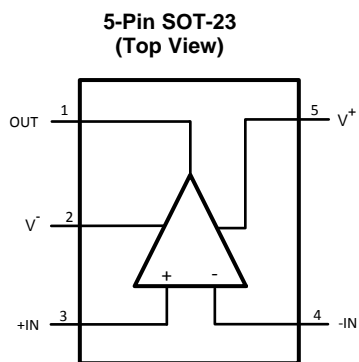

See Package Number D0008A

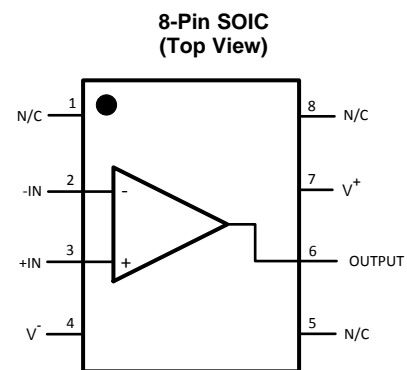

See Package Number DBV0005A

Typical Performance Characteristics

Small Signal Non-Inverting Frequency Response

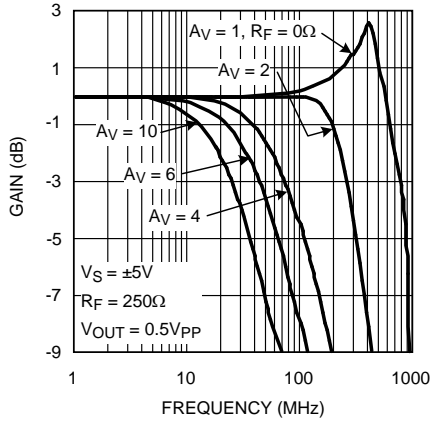

Figure 2.

Large Signal Non-Inverting Frequency Response

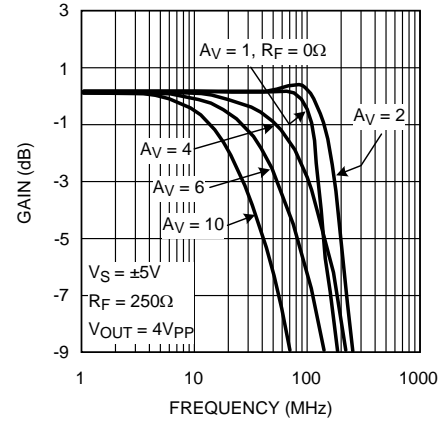

Figure 3.

Small Signal Inverting Frequency Response

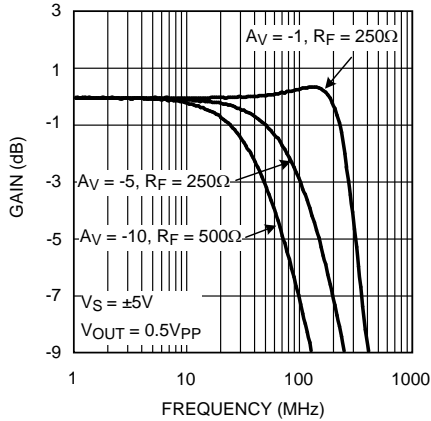

Figure 4.

Large Signal Inverting Frequency Response

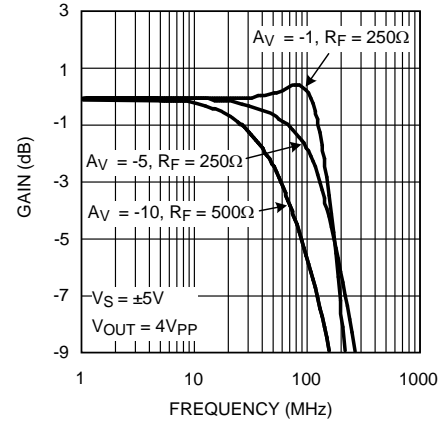

Figure 5.

Frequency Response vs. $V_{OUT} A_V = 2$

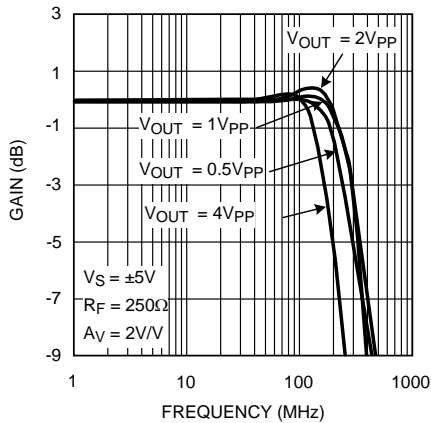

Figure 6.

Frequency Response vs. $V_{OUT} A_V = 2$

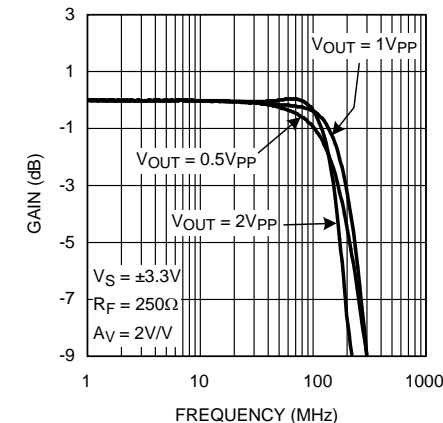

Figure 7.

Typical Performance Characteristics (continued)

Frequency Response vs. $V_{OUT} A_V = 1$

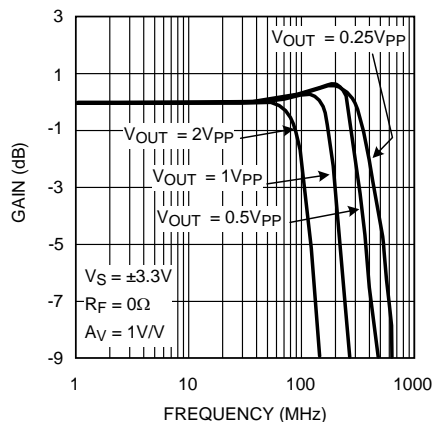

Figure 8.

Frequency Response vs. $V_{OUT} A_V = -1$

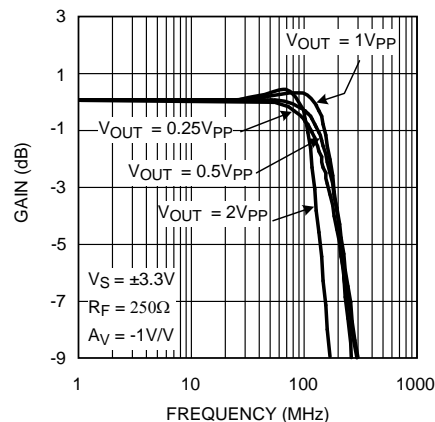

Figure 9.

Frequency Response vs. $V_{OUT} A_V = -1$

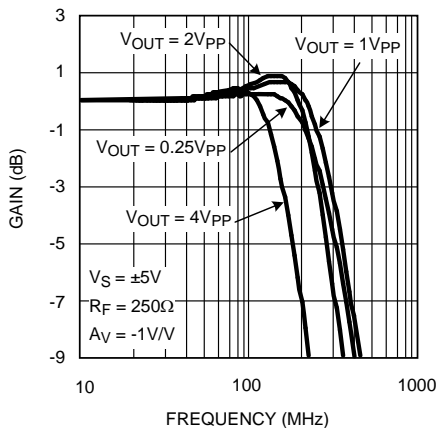

Figure 10.

Frequency Response vs. Cap Load

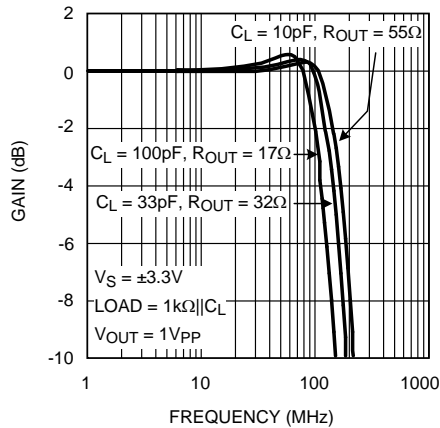

Figure 11.

Frequency Response vs. Cap Load

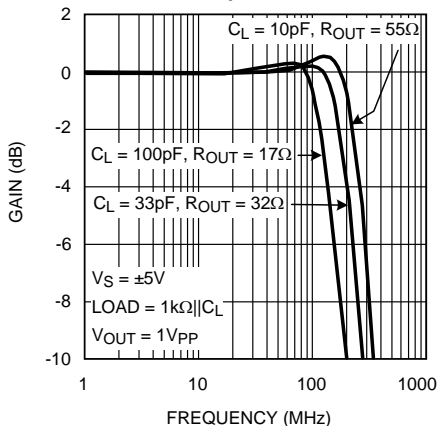

Figure 12.

Suggested R_OUT vs. Cap Load

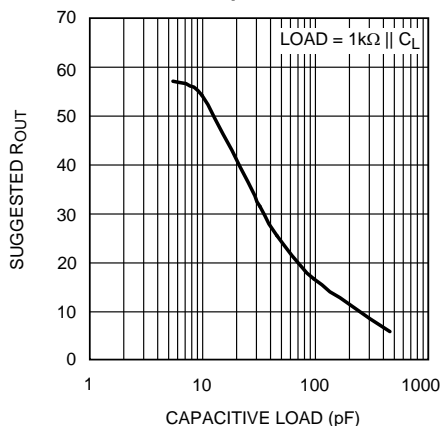

Figure 13.

Typical Performance Characteristics (continued)

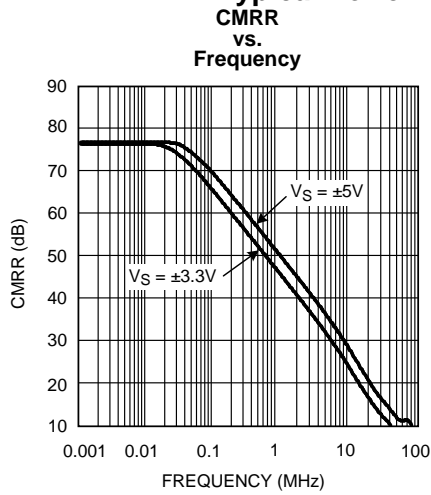

Figure 14.

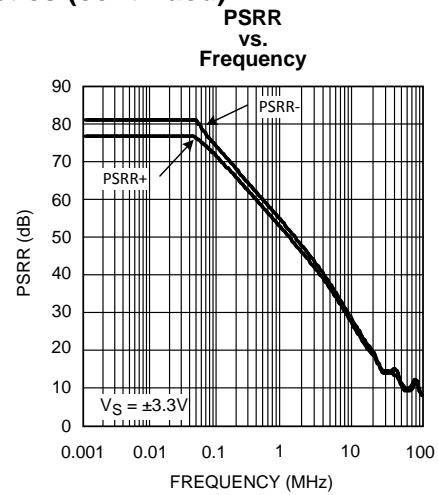

Figure 15.

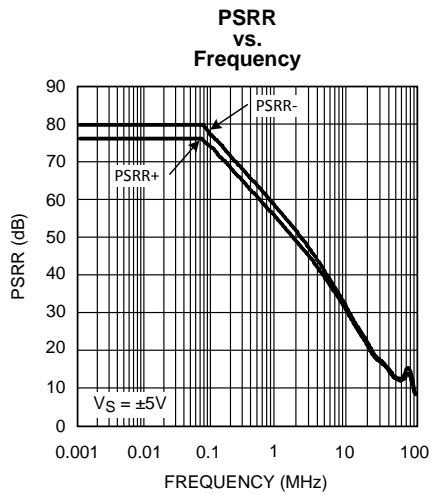

Figure 16.

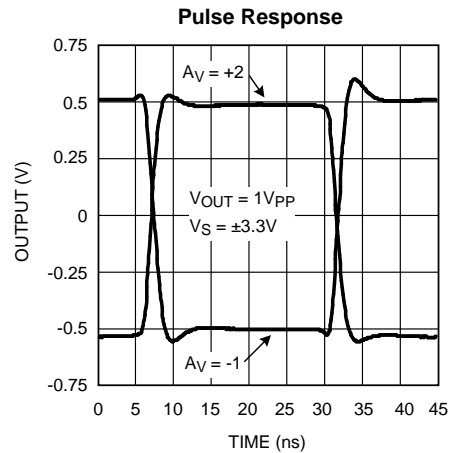

Figure 17.

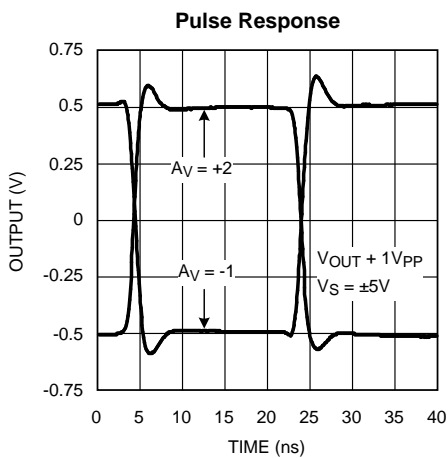

Figure 18.

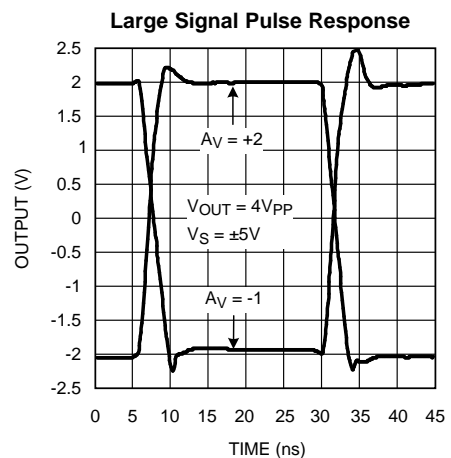

Figure 19.

Typical Performance Characteristics (continued)

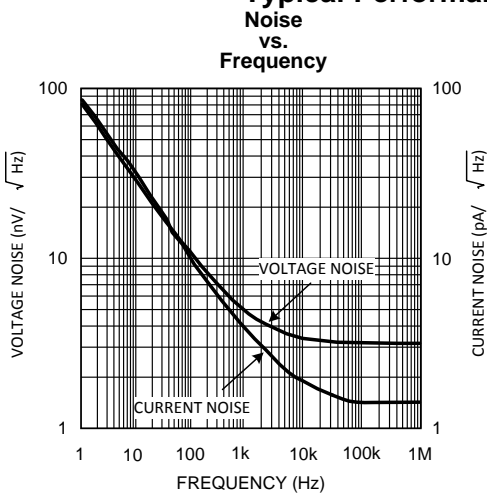

Figure 20.

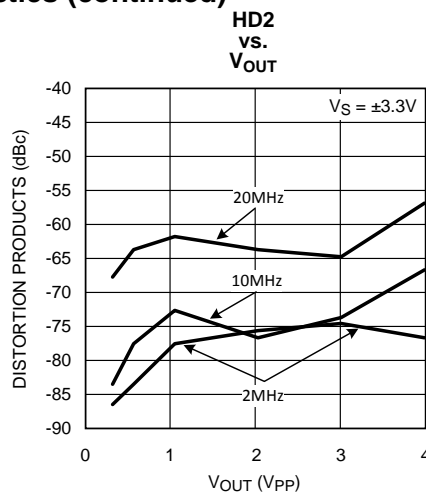

Figure 21.

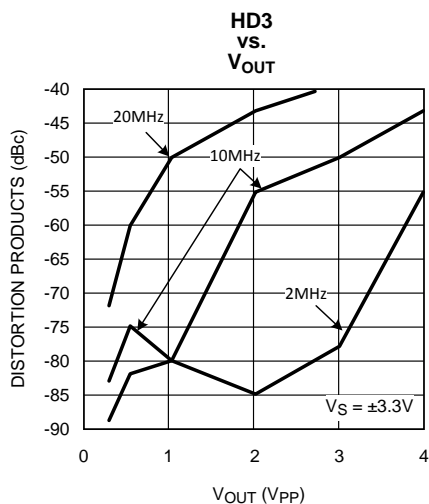

Figure 22.

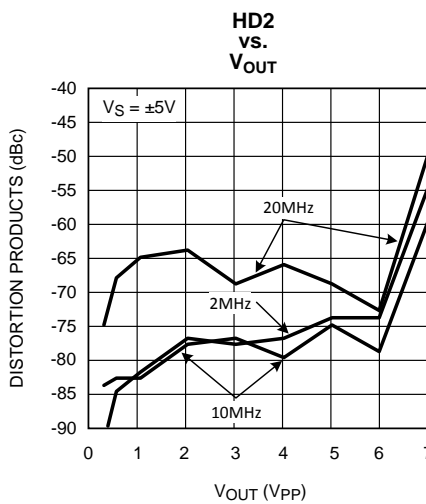

Figure 23.

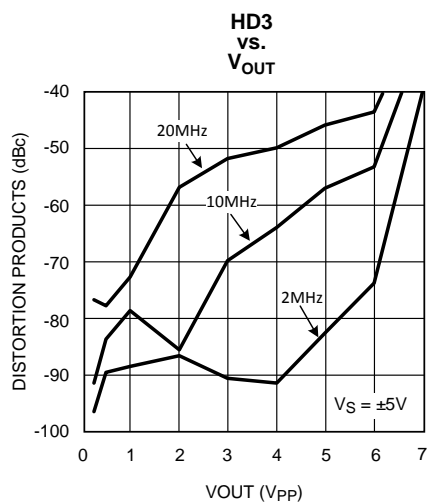

Figure 24.

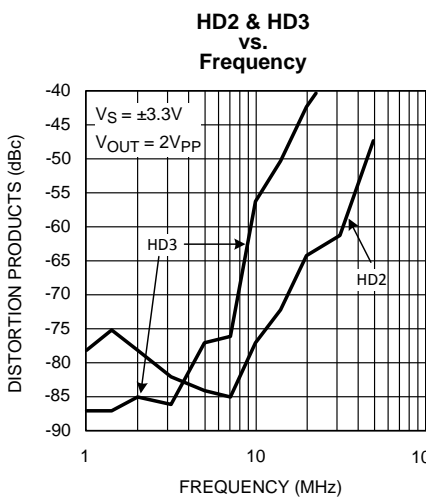

Figure 25.

Typical Performance Characteristics (continued)
HD2 & HD3
vs.
Frequency

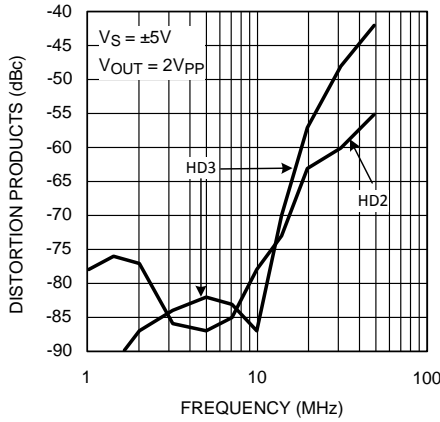

Figure 26.

Differential Gain & Phase

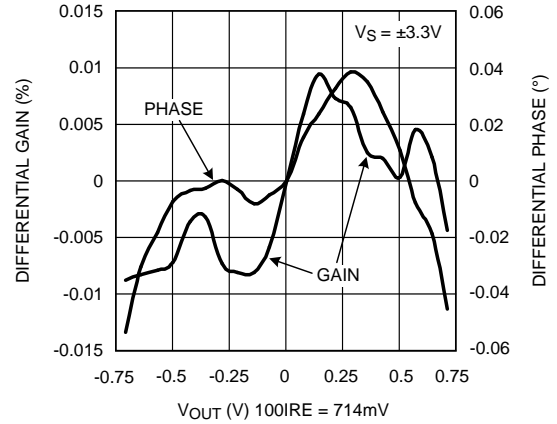

Figure 27.

Differential Gain & Phase

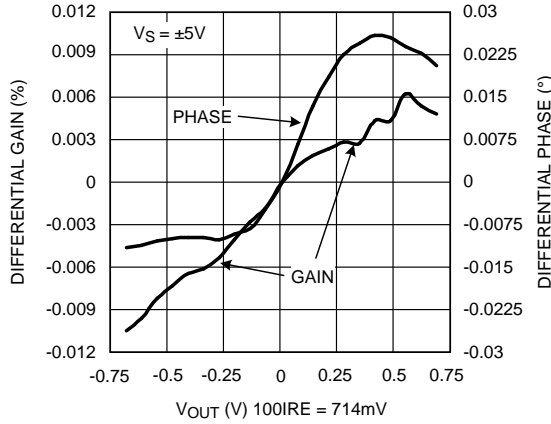

Figure 28.

Open Loop Gain & Phase

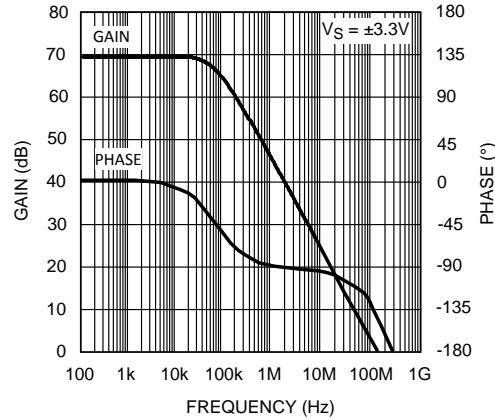

Figure 29.

Open Loop Gain & Phase

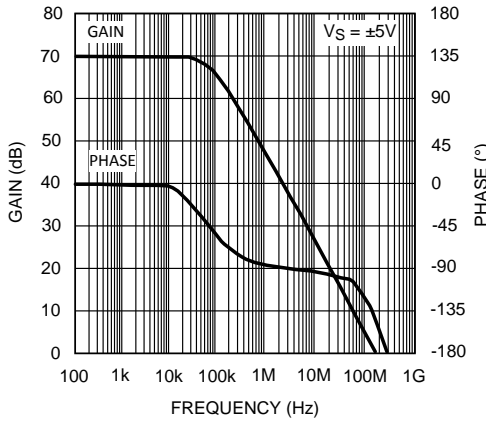

Figure 30.

Closed Loop Output Resistance

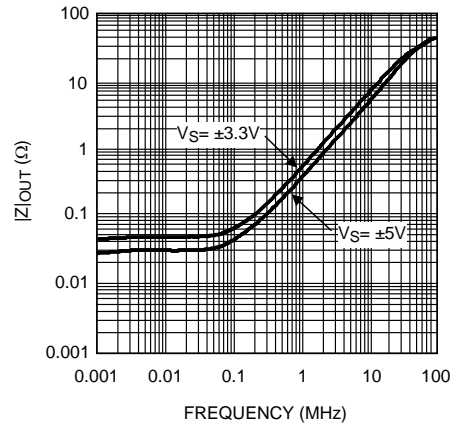

Figure 31.

APPLICATION INFORMATION

GENERAL DESIGN EQUATION

The LMH6609 is a unity gain stable voltage feedback amplifier. The matched input bias currents track well over temperature. This allows the DC offset to be minimized by matching the impedance seen by both inputs.

GAIN

The non-inverting and inverting gain equations for the LMH6609 are as follows:

$$\text{NON-INVERTING GAIN : } 1 + \frac{R_F}{R_G}$$

$$\text{INVERTING GAIN : } - \frac{R_F}{R_G}$$

(1)

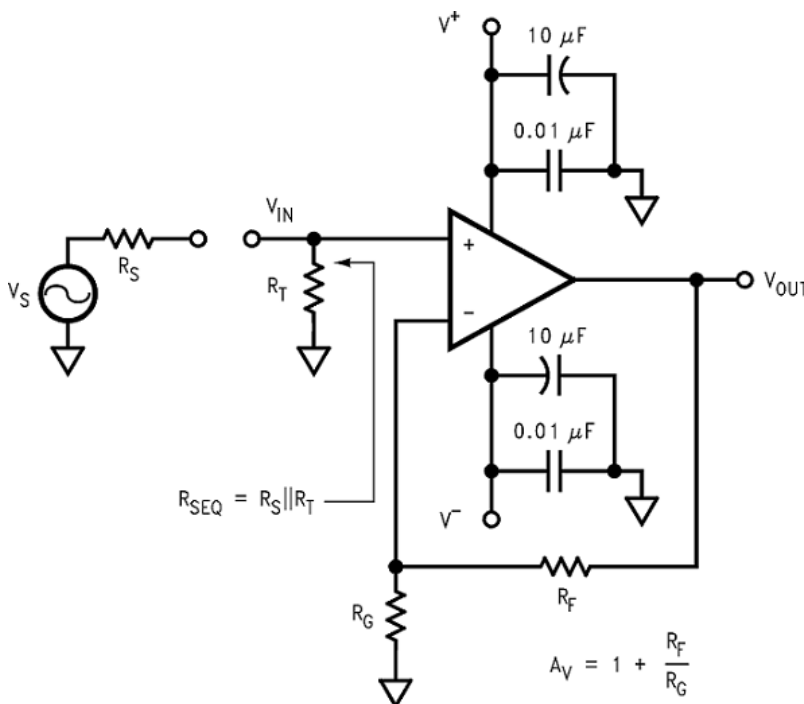

Figure 32. Typical Non-Inverting Application

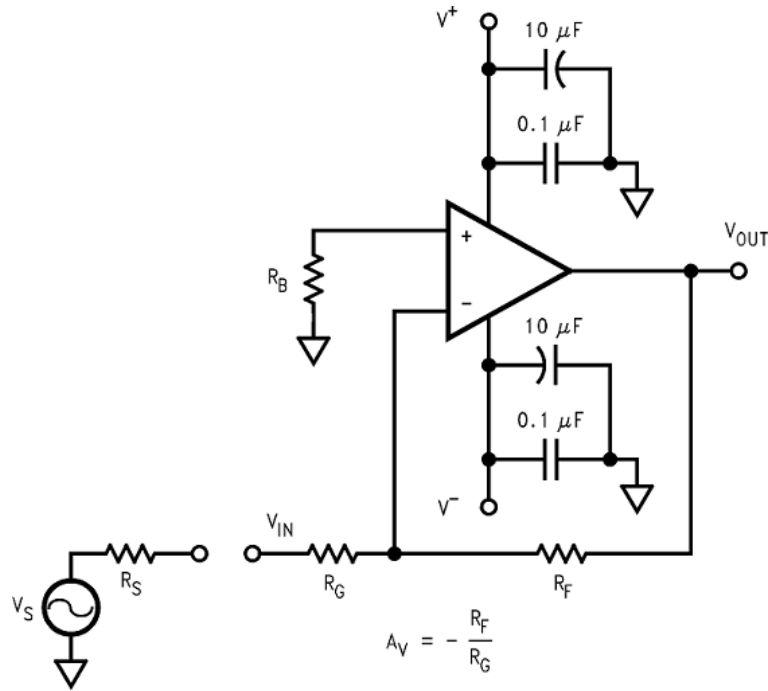

Figure 33. Typical Inverting Application

Note: R_B , provides DC bias for non-inverting input.

R_B , R_L and R_T are tied to $V^+/2$ for minimum power consumption and maximum output swing.

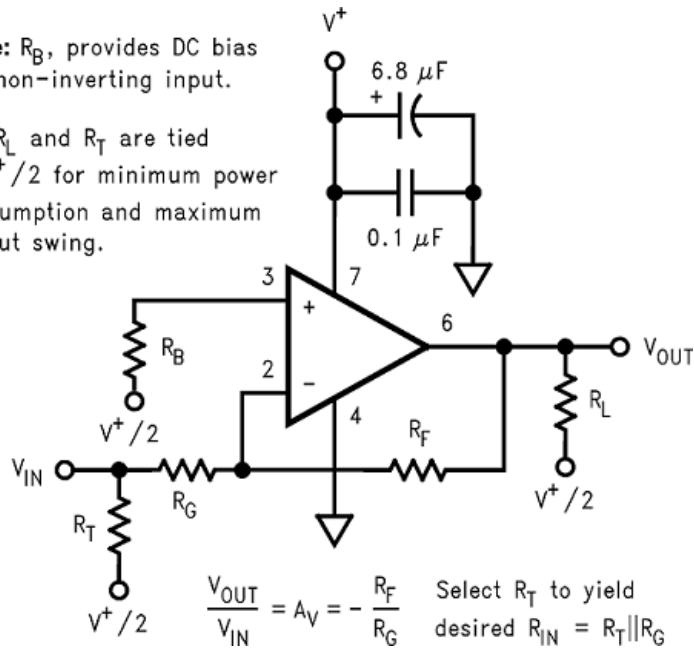

Figure 34. Single Supply Inverting

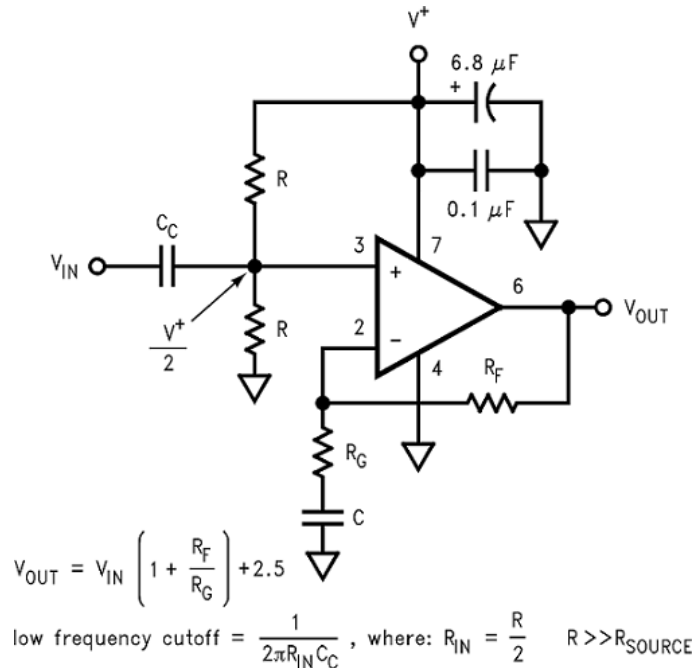

Figure 35. AC Coupled Non-Inverting

GAIN BANDWIDTH PRODUCT

The LMH6609 is a voltage feedback amplifier, whose closed-loop bandwidth is approximately equal to the gain-bandwidth product (GBP) divided by the gain (A_V). For gains greater than 5, A_V sets the closed-loop bandwidth of the LMH6609.

$$\text{CLOSED LOOP BANDWIDTH} = \frac{\text{GBP}}{A_V}$$

$$A_V = \frac{(R_F + R_G)}{R_G}$$

$$\text{GBP} = 240\text{MHz}$$

(2)

For Gains less than 5, refer to the frequency response plots to determine maximum bandwidth. For large signal bandwidth the slew rate is a more accurate predictor of bandwidth.

$$f_{MAX} = \frac{S_R}{2\pi V_P}$$

(3)

Where f_{MAX} = bandwidth, S_R = Slew rate and V_P = peak amplitude.

OUTPUT DRIVE AND SETTLING TIME PERFORMANCE

The LMH6609 has large output current capability. The 100mA of output current makes the LMH6609 an excellent choice for applications such as:

- Video Line Drivers
- Distribution Amplifiers

When driving a capacitive load or coaxial cable, include a series resistance R_{OUT} to back match or improve settling time. Refer to the Driving Capacitive Loads section for guidance on selecting an output resistor for driving capacitive loads.

EVALUATION BOARDS

TI offers the following evaluation boards as a guide for high frequency layout and as an aid in device testing and characterization. Many of the data sheet plots were measured with these boards.

Device	Package	Board Part #
LMH6609MA	SOIC	LMH730227
LMH6609MF	SOT-23	LMH730216

CIRCUIT LAYOUT CONSIDERATION

A proper printed circuit layout is essential for achieving high frequency performance. TI provides evaluation boards for the LMH6609 as shown above. These boards were laid out for optimum, high-speed performance. The ground plane was removed near the input and output pins to reduce parasitic capacitance. Also, all trace lengths were minimized to reduce series inductances.

Supply bypassing is required for the amplifiers performance. The bypass capacitors provide a low impedance return current path at the supply pins. They also provide high frequency filtering on the power supply traces. 10 μ F tantalum and .01 μ F capacitors are recommended on both supplies (from supply to ground). In addition, a 0.1 μ F ceramic capacitor can be added from V^+ to V^- to aid in second harmonic suppression.

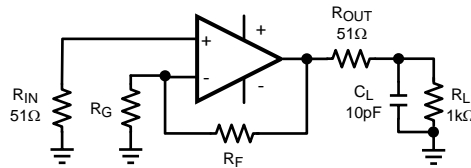

Figure 36. Driving Capacitive Loads with R_{OUT} for Improved Stability

DRIVING CAPACITIVE LOADS

Capacitive output loading applications will benefit from the use of a series output resistor R_{OUT} . Figure 36 shows the use of a series output resistor, R_{OUT} as it might be applied when driving an analog to digital converter. The charts "Suggested R_O vs. Cap Load" in the Typical Performance Section give a recommended value for mitigating capacitive loads. The values suggested in the charts are selected for .5dB or less of peaking in the frequency response. This gives a good compromise between settling time and bandwidth. For applications where maximum frequency response is needed and some peaking is tolerable, the value of R_O can be reduced slightly from the recommended values. There will be amplitude lost in the series resistor unless the gain is adjusted to compensate; this effect is most noticeable with heavy resistive loads.

COMPONENT SELECTION AND FEEDBACK RESISTOR

Surface mount components are highly recommended for the LMH6609. Leaded components will introduce unpredictable parasitic loading that will interfere with proper device operation. Do not use wire wound resistors.

The LMH6609 operates best with a feedback resistor of approximately 250Ω for all gains of +2 and greater and for –1 and less. With lower gains in particular, large value feedback resistors will exaggerate the effects of parasitic capacitances and may lead to ringing on the pulse response and frequency response peaking. Large value resistors also add undesirable thermal noise. Feedback resistors that are much below 100Ω will load the output stage, which will reduce voltage output swing, increase device power dissipation, increase distortion and reduce current available for driving the load.

In the buffer configuration the output should be shorted directly to the inverting input. This feedback does not load the output stage because the inverting input is a high impedance point and there is no gain set resistor to ground.

OPTIMIZING DC ACCURACY

The LMH6609 offers excellent DC accuracy. The well-matched inputs of this amplifier allows even better performance if care is taken to balance the impedances seen by the two inputs. The parallel combination of the gain setting R_G and feedback R_F resistors should be equal to R_{SEQ} , the resistance of the source driving the op amp in parallel with any terminating Resistor (See [Figure 32](#)). Combining this with the non inverting gain equation gives the following parameters:

$$R_F = A_{VRSEQ}$$

$$R_G = R_F / (A_V - 1)$$

For Inverting gains the bias current cancellation is accomplished by placing a resistor R_B on the non-inverting input equal in value to the resistance seen by the inverting input (See [Figure 33](#)). $R_B = R_F \parallel (R_G + R_S)$

The additional noise contribution of R_B can be minimized by the use of a shunt capacitor (not shown).

POWER DISSIPATION

The LMH6609 has the ability to drive large currents into low impedance loads. Some combinations of ambient temperature and device loading could result in device overheating. For most conditions peak power values are not as important as RMS powers. To determine the maximum allowable power dissipation for the LMH6609 use the following formula:

$$P_{MAX} = (150^\circ - T_{AMB}) / \theta_{JA} \quad (4)$$

Where T_{AMB} = Ambient temperature (°C) and θ_{JA} = Thermal resistance, from junction to ambient, for a given package (°C/W). For the SOIC package θ_{JA} is 148°C/W, for the SOT-23 it is 250°C/W. 150°C is the absolute maximum limit for the internal temperature of the device.

Either forced air cooling or a heat sink can greatly increase the power handling capability for the LMH6609.

VIDEO PERFORMANCE

The LMH6609 has been designed to provide good performance with both PAL and NTSC composite video signals. The LMH6609 is specified for PAL signals. NTSC performance is typically marginally better due to the lower frequency content of the signal. Performance degrades as the loading is increased, therefore best performance will be obtained with back-terminated loads. The back termination reduces reflections from the transmission line and effectively masks transmission line and other parasitic capacitances from the amplifier output stage. This means that the device should be configured for a gain of 2 in order to have a net gain of 1 after the terminating resistor. (See [Figure 37](#))

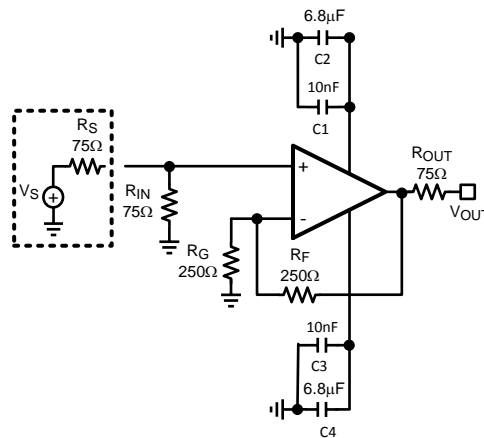

Figure 37. Typical Video Application

ESD PROTECTION

The LMH6609 is protected against electrostatic discharge (ESD) on all pins. The LMH6609 will survive 2000V Human Body model or 200V Machine model events.

Under closed loop operation the ESD diodes have no effect on circuit performance. There are occasions, however, when the ESD diodes may be evident. For instance, if the amplifier is powered down and a large input signal is applied the ESD diodes will conduct.

TRANSIMPEDANCE AMPLIFIER

The low input current noise and unity gain stability of the LMH6609 make it an excellent choice for transimpedance applications. [Figure 38](#) illustrates a low noise transimpedance amplifier that is commonly implemented with photo diodes. R_F sets the transimpedance gain. The photo diode current multiplied by R_F determines the output voltage.

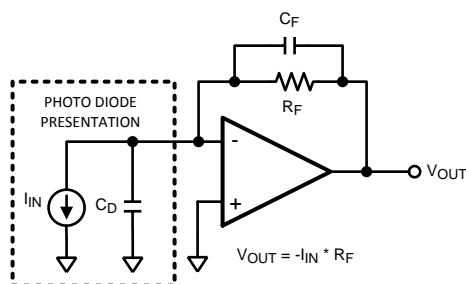

Figure 38. Transimpedance Amplifier

The capacitances are defined as:

- C_D = Equivalent Diode Capacitance
- C_F = Feedback Capacitance

The feedback capacitor is used to give optimum flatness and stability. As a starting point the feedback capacitance should be chosen as $\frac{1}{2}$ of the Diode capacitance. Lower feedback capacitors will peak frequency response.

Rectifier

The large bandwidth of the LMH6609 allows for high-speed rectification. A common rectifier topology is shown in Figure 39. R_1 and R_2 set the gain of the rectifier.

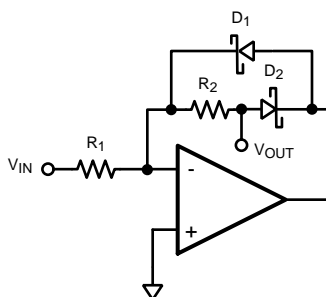

Figure 39. Rectifier Topology

REVISION HISTORY

Changes from Revision E (March 2013) to Revision F	Page
• Changed layout of National Data Sheet to TI format	17

PACKAGING INFORMATION

Orderable part number	Status (1)	Material type (2)	Package Pins	Package qty Carrier	RoHS (3)	Lead finish/ Ball material (4)	MSL rating/ Peak reflow (5)	Op temp (°C)	Part marking (6)
LMH6609 MDC	Active	Production	DIESALE (Y) 0	400 NOT REQUIRED	Yes	Call TI	Level-1-NA-UNLIM	-40 to 85	
LMH6609-MDC.A	Active	Production	DIESALE (Y) 0	400 NOT REQUIRED	Yes	Call TI	Level-1-NA-UNLIM	-40 to 85	
LMH6609MA/NOPB	Active	Production	SOIC (D) 8	95 TUBE	Yes	SN	Level-1-260C-UNLIM	-40 to 85	LMH66 09MA
LMH6609MA/NOPB.A	Active	Production	SOIC (D) 8	95 TUBE	Yes	SN	Level-1-260C-UNLIM	-40 to 85	LMH66 09MA
LMH6609MAX/NOPB	Active	Production	SOIC (D) 8	2500 LARGE T&R	Yes	SN	Level-1-260C-UNLIM	-40 to 85	LMH66 09MA
LMH6609MAX/NOPB.A	Active	Production	SOIC (D) 8	2500 LARGE T&R	Yes	SN	Level-1-260C-UNLIM	-40 to 85	LMH66 09MA
LMH6609MF/NOPB	Active	Production	SOT-23 (DBV) 5	1000 SMALL T&R	Yes	SN	Level-1-260C-UNLIM	-40 to 85	A89A
LMH6609MF/NOPB.A	Active	Production	SOT-23 (DBV) 5	1000 SMALL T&R	Yes	SN	Level-1-260C-UNLIM	-40 to 85	A89A
LMH6609MFX/NOPB	Active	Production	SOT-23 (DBV) 5	3000 LARGE T&R	Yes	SN	Level-1-260C-UNLIM	-40 to 85	A89A
LMH6609MFX/NOPB.A	Active	Production	SOT-23 (DBV) 5	3000 LARGE T&R	Yes	SN	Level-1-260C-UNLIM	-40 to 85	A89A

(1) **Status:** For more details on status, see our [product life cycle](#).

(2) **Material type:** When designated, preproduction parts are prototypes/experimental devices, and are not yet approved or released for full production. Testing and final process, including without limitation quality assurance, reliability performance testing, and/or process qualification, may not yet be complete, and this item is subject to further changes or possible discontinuation. If available for ordering, purchases will be subject to an additional waiver at checkout, and are intended for early internal evaluation purposes only. These items are sold without warranties of any kind.

(3) **RoHS values:** Yes, No, RoHS Exempt. See the [TI RoHS Statement](#) for additional information and value definition.

(4) **Lead finish/Ball material:** Parts may have multiple material finish options. Finish options are separated by a vertical ruled line. Lead finish/Ball material values may wrap to two lines if the finish value exceeds the maximum column width.

(5) **MSL rating/Peak reflow:** The moisture sensitivity level ratings and peak solder (reflow) temperatures. In the event that a part has multiple moisture sensitivity ratings, only the lowest level per JEDEC standards is shown. Refer to the shipping label for the actual reflow temperature that will be used to mount the part to the printed circuit board.

(6) **Part marking:** There may be an additional marking, which relates to the logo, the lot trace code information, or the environmental category of the part.

Multiple part markings will be inside parentheses. Only one part marking contained in parentheses and separated by a "~" will appear on a part. If a line is indented then it is a continuation of the previous line and the two combined represent the entire part marking for that device.

Important Information and Disclaimer: The information provided on this page represents TI's knowledge and belief as of the date that it is provided. TI bases its knowledge and belief on information provided by third parties, and makes no representation or warranty as to the accuracy of such information. Efforts are underway to better integrate information from third parties. TI has taken and continues to take reasonable steps to provide representative and accurate information but may not have conducted destructive testing or chemical analysis on incoming materials and chemicals. TI and TI suppliers consider certain information to be proprietary, and thus CAS numbers and other limited information may not be available for release.

In no event shall TI's liability arising out of such information exceed the total purchase price of the TI part(s) at issue in this document sold by TI to Customer on an annual basis.

TAPE AND REEL INFORMATION

QUADRANT ASSIGNMENTS FOR PIN 1 ORIENTATION IN TAPE



*All dimensions are nominal

Device	Package Type	Package Drawing	Pins	SPQ	Reel Diameter (mm)	Reel Width W1 (mm)	A0 (mm)	B0 (mm)	K0 (mm)	P1 (mm)	W (mm)	Pin1 Quadrant
LMH6609MAX/NOPB	SOIC	D	8	2500	330.0	12.4	6.5	5.4	2.0	8.0	12.0	Q1
LMH6609MF/NOPB	SOT-23	DBV	5	1000	178.0	8.4	3.2	3.2	1.4	4.0	8.0	Q3
LMH6609MFX/NOPB	SOT-23	DBV	5	3000	178.0	8.4	3.2	3.2	1.4	4.0	8.0	Q3

TAPE AND REEL BOX DIMENSIONS

*All dimensions are nominal

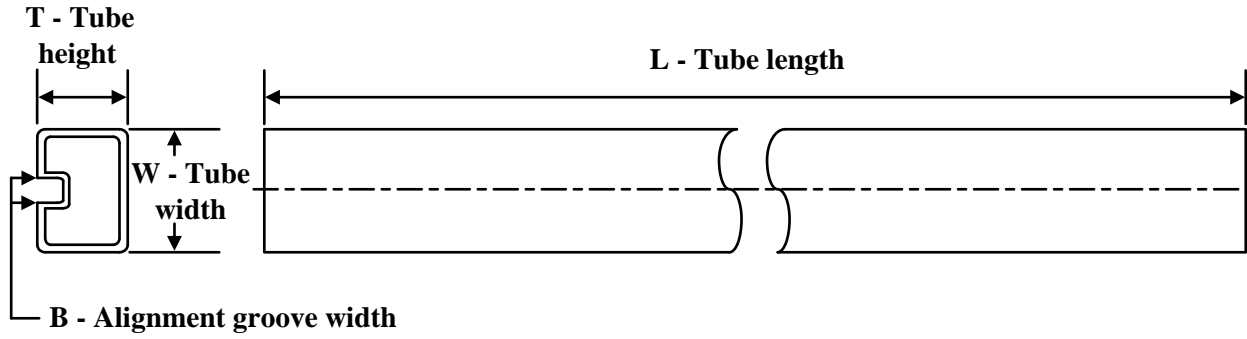
Device	Package Type	Package Drawing	Pins	SPQ	Length (mm)	Width (mm)	Height (mm)
LMH6609MAX/NOPB	SOIC	D	8	2500	367.0	367.0	35.0
LMH6609MF/NOPB	SOT-23	DBV	5	1000	208.0	191.0	35.0
LMH6609MFX/NOPB	SOT-23	DBV	5	3000	208.0	191.0	35.0

TUBE

*All dimensions are nominal

Device	Package Name	Package Type	Pins	SPQ	L (mm)	W (mm)	T (μm)	B (mm)
LMH6609MA/NOPB	D	SOIC	8	95	495	8	4064	3.05
LMH6609MA/NOPB.A	D	SOIC	8	95	495	8	4064	3.05



D0008A

PACKAGE OUTLINE

SOIC - 1.75 mm max height

SMALL OUTLINE INTEGRATED CIRCUIT

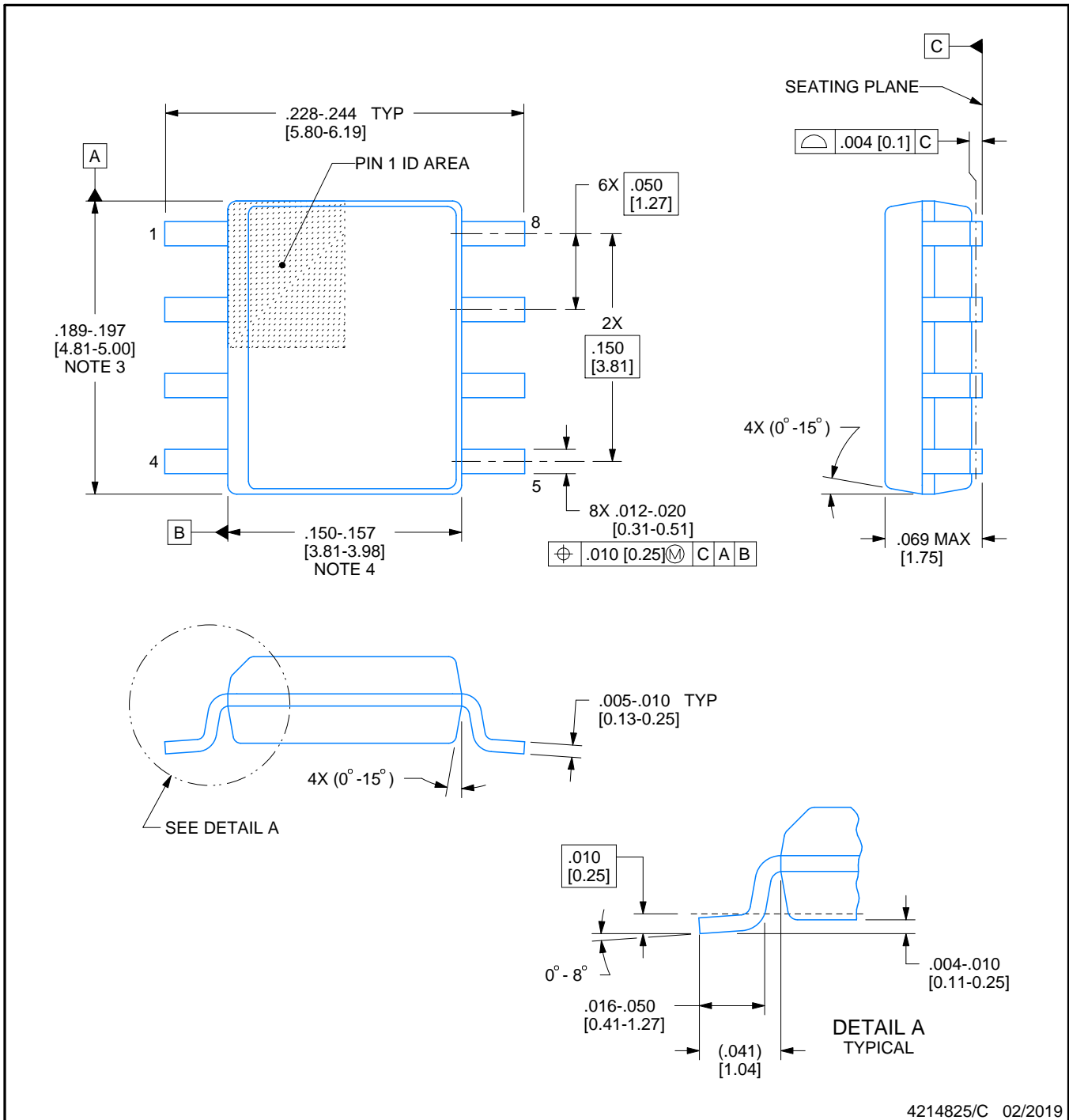

4214825/C 02/2019

NOTES:

- Linear dimensions are in inches [millimeters]. Dimensions in parenthesis are for reference only. Controlling dimensions are in inches. Dimensioning and tolerancing per ASME Y14.5M.
- This drawing is subject to change without notice.
- This dimension does not include mold flash, protrusions, or gate burrs. Mold flash, protrusions, or gate burrs shall not exceed $.006$ [0.15] per side.
- This dimension does not include interlead flash.
- Reference JEDEC registration MS-012, variation AA.

EXAMPLE BOARD LAYOUT

D0008A

SOIC - 1.75 mm max height

SMALL OUTLINE INTEGRATED CIRCUIT



LAND PATTERN EXAMPLE
EXPOSED METAL SHOWN
SCALE:8X



SOLDER MASK DETAILS

4214825/C 02/2019

NOTES: (continued)

- 6. Publication IPC-7351 may have alternate designs.
- 7. Solder mask tolerances between and around signal pads can vary based on board fabrication site.

EXAMPLE STENCIL DESIGN

D0008A

SOIC - 1.75 mm max height

SMALL OUTLINE INTEGRATED CIRCUIT



SOLDER PASTE EXAMPLE
BASED ON .005 INCH [0.125 MM] THICK STENCIL
SCALE:8X

4214825/C 02/2019

NOTES: (continued)

8. Laser cutting apertures with trapezoidal walls and rounded corners may offer better paste release. IPC-7525 may have alternate design recommendations.
9. Board assembly site may have different recommendations for stencil design.

DBV0005A



PACKAGE OUTLINE

SOT-23 - 1.45 mm max height

SMALL OUTLINE TRANSISTOR

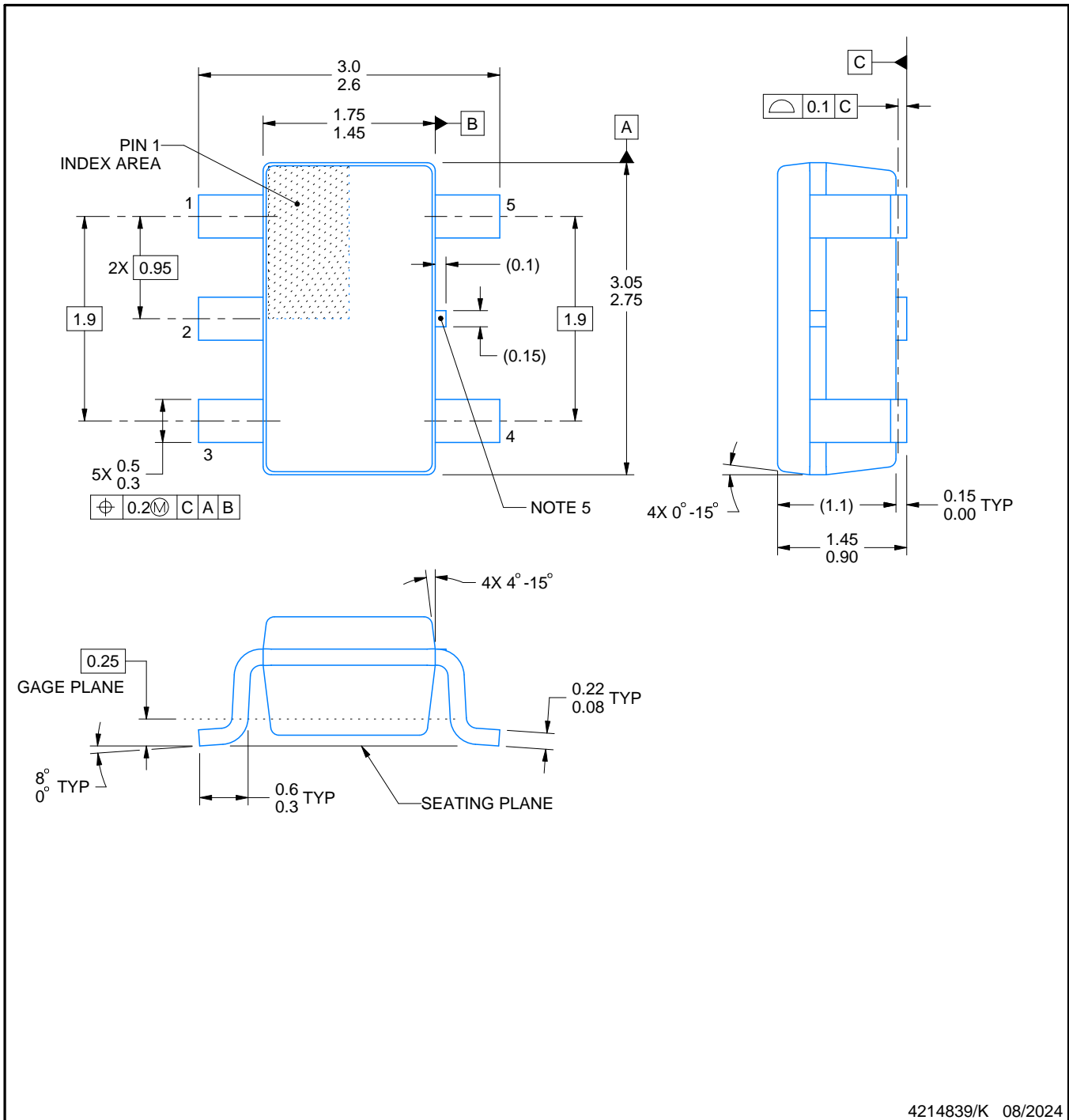

4214839/K 08/2024

NOTES:

1. All linear dimensions are in millimeters. Any dimensions in parenthesis are for reference only. Dimensioning and tolerancing per ASME Y14.5M.
2. This drawing is subject to change without notice.
3. Reference JEDEC MO-178.
4. Body dimensions do not include mold flash, protrusions, or gate burrs. Mold flash, protrusions, or gate burrs shall not exceed 0.25 mm per side.
5. Support pin may differ or may not be present.

EXAMPLE BOARD LAYOUT

DBV0005A

SOT-23 - 1.45 mm max height

SMALL OUTLINE TRANSISTOR

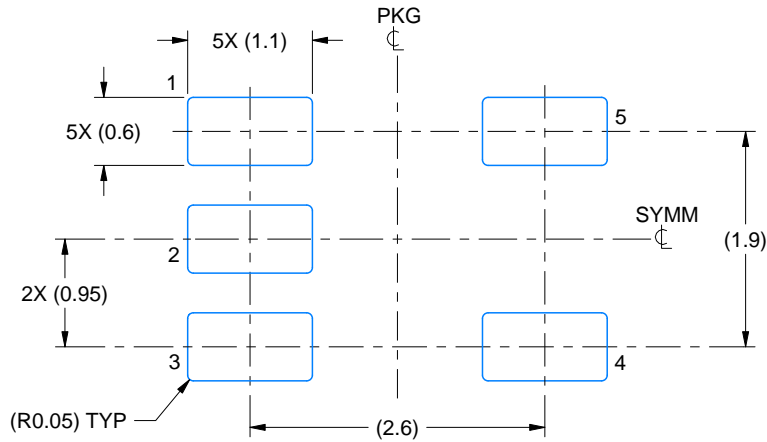

LAND PATTERN EXAMPLE
EXPOSED METAL SHOWN
SCALE:15X

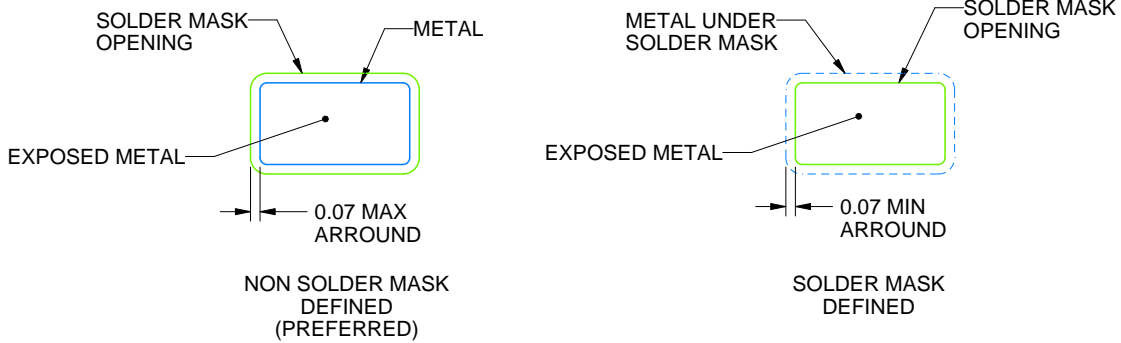

SOLDER MASK DETAILS

4214839/K 08/2024

NOTES: (continued)

- 6. Publication IPC-7351 may have alternate designs.
- 7. Solder mask tolerances between and around signal pads can vary based on board fabrication site.

EXAMPLE STENCIL DESIGN

DBV0005A

SOT-23 - 1.45 mm max height

SMALL OUTLINE TRANSISTOR

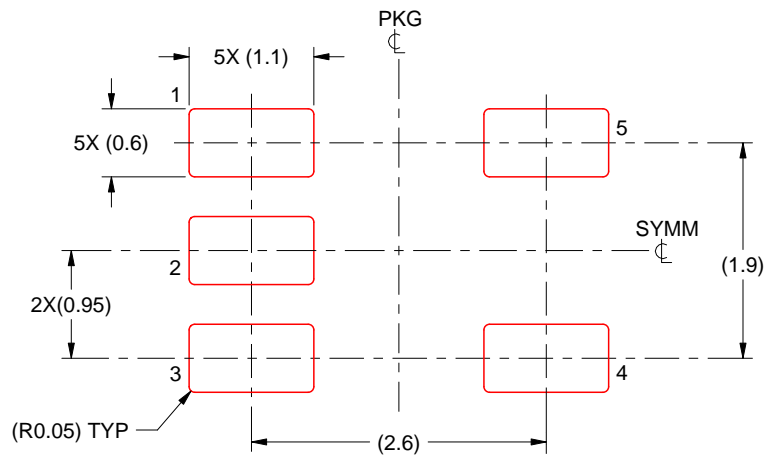

SOLDER PASTE EXAMPLE
BASED ON 0.125 mm THICK STENCIL
SCALE:15X

4214839/K 08/2024

NOTES: (continued)

8. Laser cutting apertures with trapezoidal walls and rounded corners may offer better paste release. IPC-7525 may have alternate design recommendations.
9. Board assembly site may have different recommendations for stencil design.

IMPORTANT NOTICE AND DISCLAIMER

TI PROVIDES TECHNICAL AND RELIABILITY DATA (INCLUDING DATA SHEETS), DESIGN RESOURCES (INCLUDING REFERENCE DESIGNS), APPLICATION OR OTHER DESIGN ADVICE, WEB TOOLS, SAFETY INFORMATION, AND OTHER RESOURCES "AS IS" AND WITH ALL FAULTS, AND DISCLAIMS ALL WARRANTIES, EXPRESS AND IMPLIED, INCLUDING WITHOUT LIMITATION ANY IMPLIED WARRANTIES OF MERCHANTABILITY, FITNESS FOR A PARTICULAR PURPOSE OR NON-INFRINGEMENT OF THIRD PARTY INTELLECTUAL PROPERTY RIGHTS.

These resources are intended for skilled developers designing with TI products. You are solely responsible for (1) selecting the appropriate TI products for your application, (2) designing, validating and testing your application, and (3) ensuring your application meets applicable standards, and any other safety, security, regulatory or other requirements.

These resources are subject to change without notice. TI grants you permission to use these resources only for development of an application that uses the TI products described in the resource. Other reproduction and display of these resources is prohibited. No license is granted to any other TI intellectual property right or to any third party intellectual property right. TI disclaims responsibility for, and you will fully indemnify TI and its representatives against, any claims, damages, costs, losses, and liabilities arising out of your use of these resources.

TI's products are provided subject to [TI's Terms of Sale](#) or other applicable terms available either on [ti.com](#) or provided in conjunction with such TI products. TI's provision of these resources does not expand or otherwise alter TI's applicable warranties or warranty disclaimers for TI products.

TI objects to and rejects any additional or different terms you may have proposed.

Mailing Address: Texas Instruments, Post Office Box 655303, Dallas, Texas 75265

Copyright © 2025, Texas Instruments Incorporated