

## LMC6482QML CMOS Dual Rail-To-Rail Input and Output Operational Amplifier

Check for Samples: [LMC6482QML](#)

### FEATURES

(Typical unless otherwise noted)

- Rail-to-Rail Input Common-Mode Voltage Range (Ensured Over Temperature)
- Rail-to-Rail Output Swing (within 20mV of supply rail, 100K $\Omega$  load)
- Ensured 5V and 15V Performance
- Excellent CMRR and PSRR: 82dB
- Ultra Low Input Current: 20fA
- High Voltage Gain ( $R_L = 500K\Omega$ ): 130dB
- Specified for 2K $\Omega$  and 600 $\Omega$  loads

### APPLICATIONS

- Data Acquisition Systems
- Transducer Amplifiers
- Hand-held Analytic Instruments
- Medical Instrumentation
- Active Filter, Peak Detector, Sample and Hold, pH Meter, Current Source
- Improved Replacement for TLC272, TLC277

### DESCRIPTION

The LMC6482 provides a common-mode range that extends to both supply rails. This rail-to-rail performance combined with excellent accuracy, due to a high CMRR, makes it unique among rail-to-rail input amplifiers.

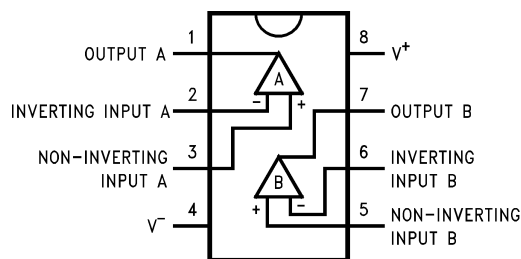
It is ideal for systems, such as data acquisition, that require a large input signal range. The LMC6482 is also an excellent upgrade for circuits using limited common-mode range amplifiers such as the TLC272 and TLC277.

Maximum dynamic signal range is assured in low voltage and single supply systems by the LMC6482's rail-to-rail output swing. The LMC6482's rail-to-rail output swing is ensured for loads down to 600 $\Omega$ .

Ensured low voltage characteristics and low power dissipation make the LMC6482 especially well-suited for battery-operated systems.

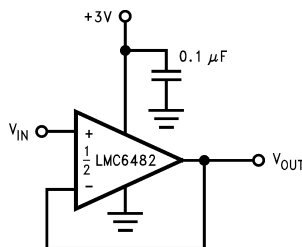
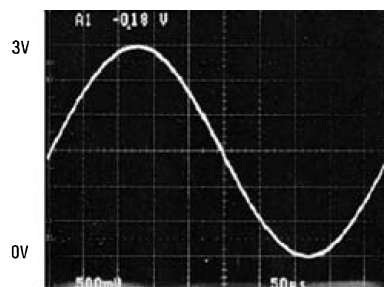
See the LMC6484 data sheet for a Quad CMOS operational amplifier with these same features.

### Connection Diagram

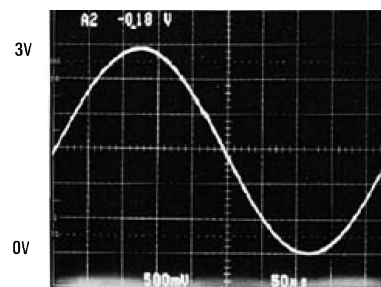


### 3V Single Supply Buffer Circuit

Rail-To-Rail Input



Rail-To-Rail Output



Please be aware that an important notice concerning availability, standard warranty, and use in critical applications of Texas Instruments semiconductor products and disclaimers thereto appears at the end of this data sheet.

All trademarks are the property of their respective owners.



These devices have limited built-in ESD protection. The leads should be shorted together or the device placed in conductive foam during storage or handling to prevent electrostatic damage to the MOS gates.

### Absolute Maximum Ratings<sup>(1)</sup>

Supply Voltage (V <sup>+</sup> – V <sup>-</sup> )			16V
Differential Input Voltage			± Supply Voltage
Voltage at Input/Output Pin			(V <sup>+</sup> ) + 0.3V, (V <sup>-</sup> ) – 0.3V
Current at Input Pin <sup>(2)</sup>			±5 mA
Current at Output Pin <sup>(3)(4)</sup>			±30 mA
Current at Power Supply Pin			40 mA
Maximum Junction Temperature (T <sub>Jmax</sub> ) <sup>(5)(3)</sup>			150°C
Power Dissipation <sup>(5)</sup>			160mW
Storage Temperature Range			-65°C ≤ T <sub>A</sub> ≤ +150°C
Thermal Resistance <sup>(6)</sup>	θ <sub>JA</sub>	8LD Ceramic DIP (Still Air)	117°C/W
		8LD Ceramic DIP (500LF/Min Air Flow)	62.0°C/W
	θ <sub>JC</sub>	8LD Ceramic DIP	16.0°C/W
		Lead Temp. (Soldering, 10 sec.)	260°C
ESD Tolerance <sup>(7)</sup>			1.5KV

- (1) Absolute Maximum Ratings indicate limits beyond which damage to the device may occur. Operating Ratings indicate conditions for which the device is functional, but do not ensure specific performance limits. For ensured specifications and test conditions, see the Electrical Characteristics. The ensured specifications apply only for the test conditions listed. Some performance characteristics may degrade when the device is not operated under the listed test conditions.
- (2) Limiting input pin current is only necessary for input voltages that exceed absolute maximum input voltage ratings.
- (3) Applies to both single supply and split-supply operation. Continuous short circuit operation at elevated ambient temperature can result in exceeding the maximum allowed junction temperature of 150°C. Output currents in excess of ±30 mA over long term may adversely affect reliability.
- (4) Do not short circuit output to V<sup>+</sup>, when V<sup>+</sup> is greater than 13V or reliability will be adversely affected.
- (5) The maximum power dissipation must be derated at elevated temperatures and is dictated by T<sub>Jmax</sub> (maximum junction temperature), θ<sub>JA</sub> (package junction to ambient thermal resistance), and T<sub>A</sub> (ambient temperature). The maximum allowable power dissipation at any temperature is P<sub>Dmax</sub> = (T<sub>Jmax</sub> - T<sub>A</sub>)/θ<sub>JA</sub> or the number given in the Absolute Maximum Ratings, whichever is lower.
- (6) All numbers apply for packages soldered directly into a PC board.
- (7) Human body model, 1.5 KΩ in series with 100 pF.

### Recommended Operating Range<sup>(1)</sup>

Supply Voltage	3.0V ≤ V <sup>+</sup> ≤ 15.5V
Operating Temperature Range	-55°C ≤ T <sub>A</sub> ≤ +125°C

- (1) Absolute Maximum Ratings indicate limits beyond which damage to the device may occur. Operating Ratings indicate conditions for which the device is functional, but do not ensure specific performance limits. For ensured specifications and test conditions, see the Electrical Characteristics. The ensured specifications apply only for the test conditions listed. Some performance characteristics may degrade when the device is not operated under the listed test conditions.

### Quality Conformance Inspection

Mil-Std-883, Method 5005 - Group A

Subgroup	Description	Temp (°C)
1	Static tests at	+25
2	Static tests at	+125
3	Static tests at	-55
4	Dynamic tests at	+25
5	Dynamic tests at	+125
6	Dynamic tests at	-55
7	Functional tests at	+25
8A	Functional tests at	+125
8B	Functional tests at	-55
9	Switching tests at	+25

**Quality Conformance Inspection (continued)**

Mil-Std-883, Method 5005 - Group A

Subgroup	Description	Temp (°C)
10	Switching tests at	+125
11	Switching tests at	-55
12	Settling time at	+25
13	Settling time at	+125
14	Settling time at	-55

**LMC6482 Electrical Characteristics DC Parameters**

 The following conditions apply, unless otherwise specified.  $V^+ = 5V$ ,  $V^- = 0V$ ,  $V_{CM} = V_O = V^+/2$  and  $R_L > 1M$ .

Symbol	Parameter	Conditions	Notes	Min	Max	Units	Sub-groups	
$V_{IO}$	Input Offset Voltage				0.75	mV	1	
					1.35	mV	2, 3	
$I_{IB}$	Input Bias Current				25	pA	1	
					100	pA	2, 3	
$I_{IO}$	Input Offset Current				25	pA	1	
					100	pA	2, 3	
CMRR	Common Mode Rejection Ratio	$0V \leq V_{CM} \leq 15.0V$ $V^+ = 15V$			65	dB	1	
					62	dB	2, 3	
		$0V \leq V_{CM} \leq 5.0V$			65	dB	1	
					62	dB	2, 3	
+PSRR	Positive Power Supply Rejection Ratio	$5V \leq V^+ \leq 15V$ $V_O = 2.5V$			65	dB	1	
					62	dB	2, 3	
-PSRR	Negative Power Supply Rejection Ratio	$-15V \leq V^- \leq -5V$ $V_O = -2.5V$ , $V^+ = 0V$			65	dB	1	
					62	dB	2, 3	
$V_{CM}$	Input Common Mode Voltage Range	$5V \leq V_{CM} \leq 15V$ For CMRR $\geq 50dB$			$V^+ + 0.25$	-0.25	V	1
					$V^+$	0.0	V	2, 3
$I_{SC}$	Output Short Circuit Current	Sourcing $V_O = 0V$			16		mA	1
					12		mA	2, 3
		Sinking $V_O = 5V$			11		mA	1
					9.0		mA	2, 3
		$V^+ = 15V$ Sourcing, $V_O = 0V$			28		mA	1
					22		mA	2, 3
$V^+ = 15V$ Sinking, $V_O = 12V$		See <sup>(1)</sup>	30		mA	1		
		See <sup>(1)</sup>	24		mA	2, 3		
$I_{CC}$	Supply Current	Both Amps			1.4		mA	1
					1.8		mA	2, 3
		Both Amps $V^+ = +15V$			1.6		mA	1
					2.0		mA	2, 3
$V_O$	Output Swing	$V^+ = 5V$ $R_L = 2K\Omega$ to $V^+/2$			4.8	0.18	V	4
					4.7	0.24	V	5, 6
		$V^+ = 5V$ $R_L = 600\Omega$ to $V^+/2$			4.5	0.50	V	4
					4.24	0.65	V	5, 6
		$V^+ = 15V$ $R_L = 2K\Omega$ to $V^+/2$			14.4	0.32	V	4
					14.2	0.45	V	5, 6
$V^+ = 15V$ $R_L = 600\Omega$ to $V^+/2$			13.4	1.00	V	4		
			13.0	1.30	V	5, 6		

 (1) Do not short circuit output to  $V^+$ , when  $V^+$  is greater than 13V or reliability will be adversely affected.

### LMC6482 Electrical Characteristics DC Parameters (continued)

The following conditions apply, unless otherwise specified.  $V^+ = 5V$ ,  $V^- = 0V$ ,  $V_{CM} = V_O = V^+/2$  and  $R_L > 1M$ .

Symbol	Parameter	Conditions	Notes	Min	Max	Units	Sub-groups
A <sub>V</sub>	Large Signal Voltage Gain	R <sub>L</sub> = 2KΩ Sourcing	See <sup>(2)</sup>	140		V/mV	4
			See <sup>(2)</sup>	84		V/mV	5, 6
		R <sub>L</sub> = 2KΩ Sinking	See <sup>(2)</sup>	35		V/mV	4
			See <sup>(2)</sup>	20		V/mV	5, 6
		R <sub>L</sub> = 600Ω Sourcing	See <sup>(2)</sup>	80		V/mV	4
			See <sup>(2)</sup>	48		V/mV	5, 6
		R <sub>L</sub> = 600Ω Sinking	See <sup>(2)</sup>	18		V/mV	4
			See <sup>(2)</sup>	13		V/mV	5, 6

(2)  $V^+ = 15V$ ,  $V_{CM} = 7.5V$  and  $R_L$  connected to 7.5V. For Sourcing tests,  $7.5V \leq V_O \leq 11.5V$ . For Sinking tests,  $3.5V \leq V_O \leq 7.5V$ .

### LMC6482 Electrical Characteristics AC Parameters

The following conditions apply, unless otherwise specified.  $V^+ = 5V$ ,  $V^- = 0V$ ,  $V_{CM} = V_O = V^+/2$  and  $R_L > 1M$ .

Symbol	Parameter	Conditions	Notes	Min	Max	Units	Sub-groups
SR	Slew Rate		See <sup>(1)</sup>	0.9		V/μS	4
			See <sup>(1)</sup>	0.6		V/μS	5, 6
GBW	Gain Bandwidth	V <sup>+</sup> = 15V Set up for non-inverting		1.25		MHz	4
				1.15		MHz	5, 6

(1)  $V^+ = 15V$ . Connected as Voltage Follower with 10V step input, 2.5V to 12.5V for +slew, and 12.5V to 2.5V for –slew.. Number specified is the slower of either the positive or negative slew rates.

### Typical Performance Characteristics

$V_S = +15V$ , Single Supply,  $T_A = 25^\circ C$  unless otherwise specified

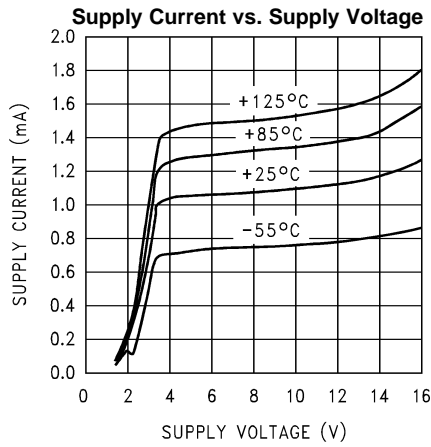


Figure 1.

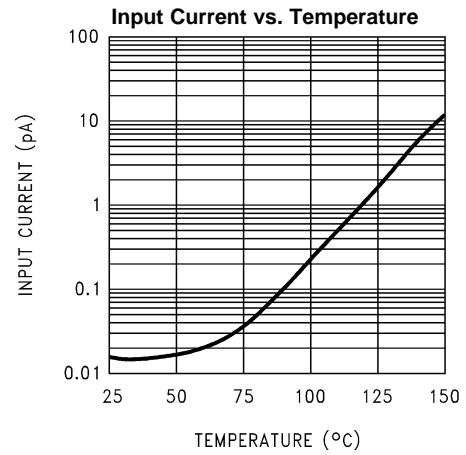


Figure 2.

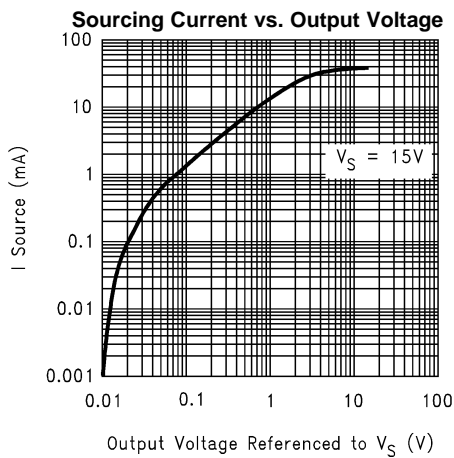


Figure 3.

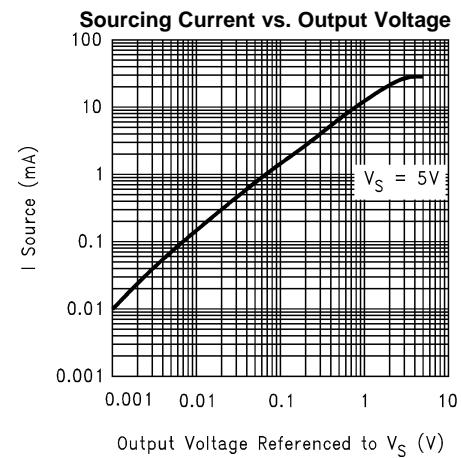


Figure 4.

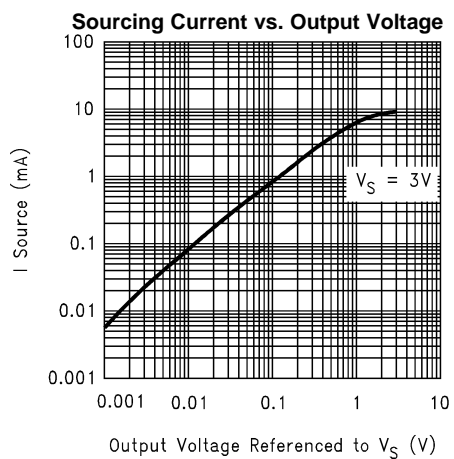


Figure 5.

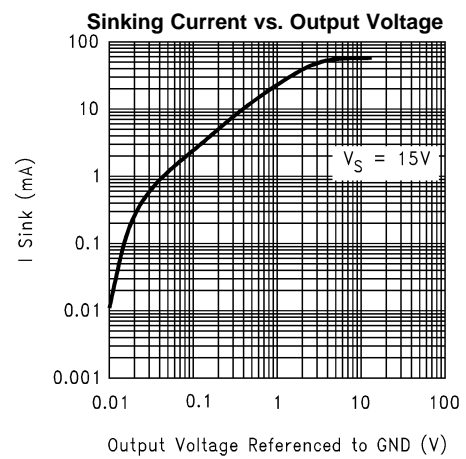


Figure 6.

**Typical Performance Characteristics (continued)**

$V_S = +15V$ , Single Supply,  $T_A = 25^\circ C$  unless otherwise specified

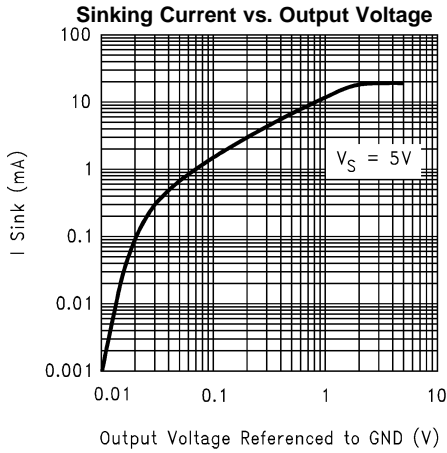


Figure 7.

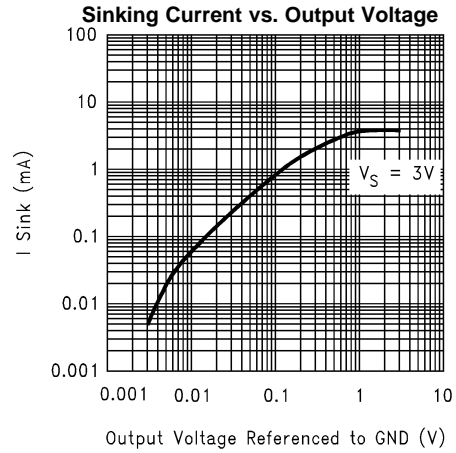


Figure 8.

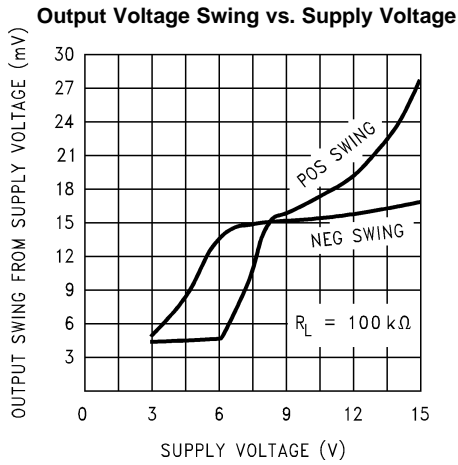


Figure 9.

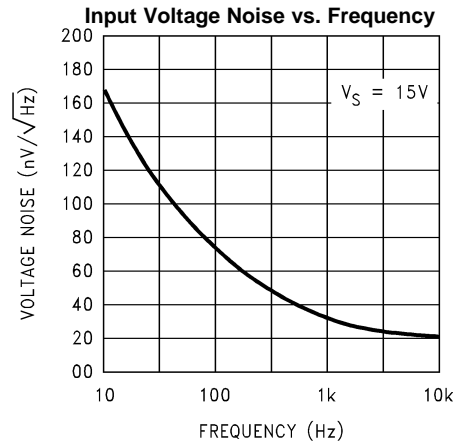


Figure 10.

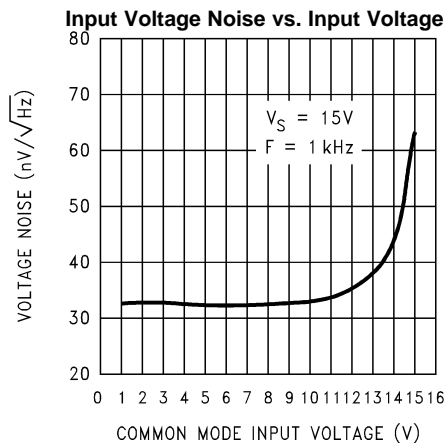


Figure 11.

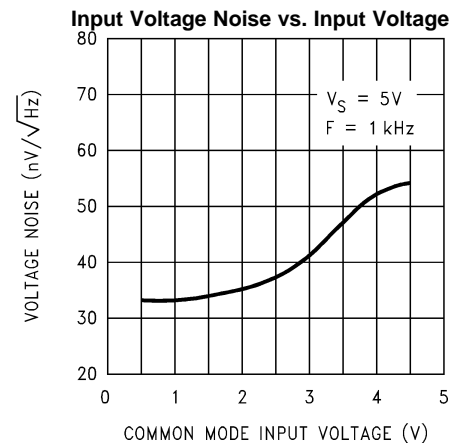


Figure 12.

Typical Performance Characteristics (continued)

$V_S = +15V$ , Single Supply,  $T_A = 25^\circ C$  unless otherwise specified

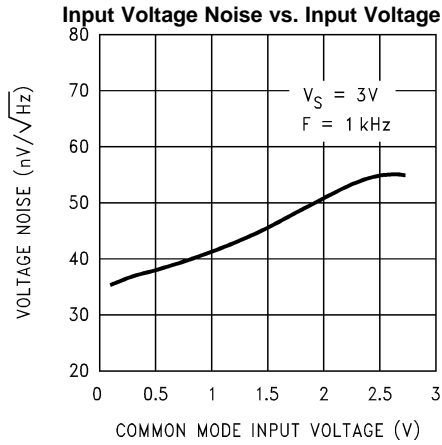


Figure 13.

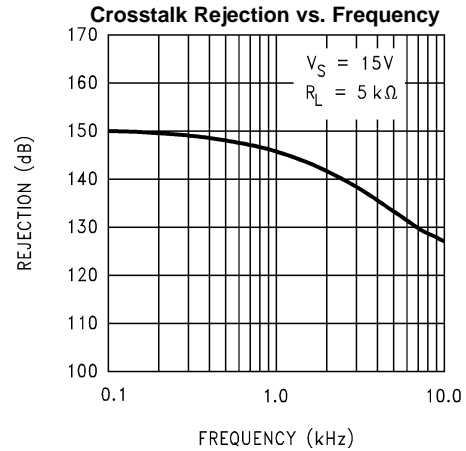


Figure 14.

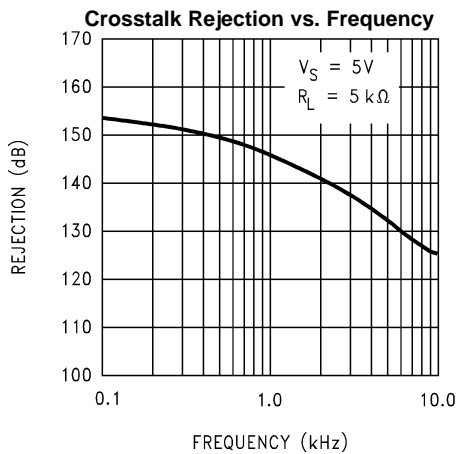


Figure 15.

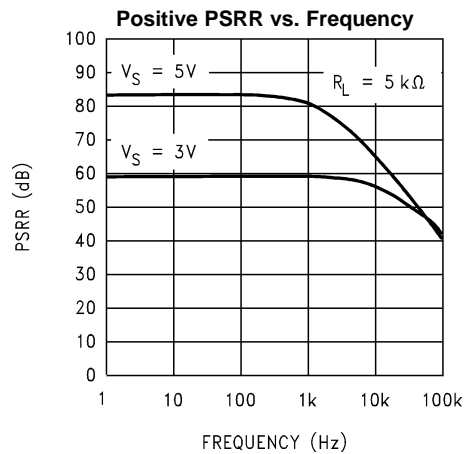


Figure 16.

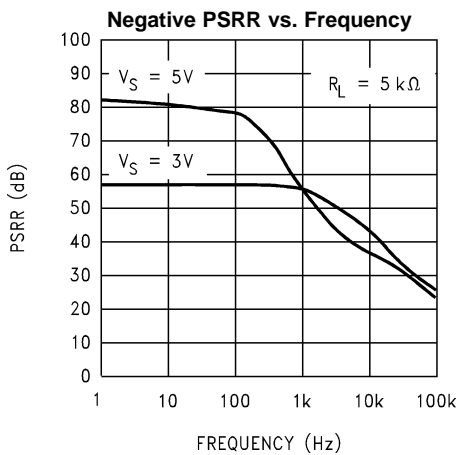


Figure 17.

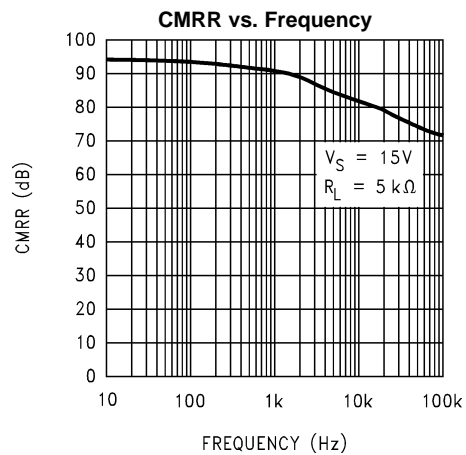


Figure 18.

Typical Performance Characteristics (continued)

$V_S = +15V$ , Single Supply,  $T_A = 25^\circ C$  unless otherwise specified

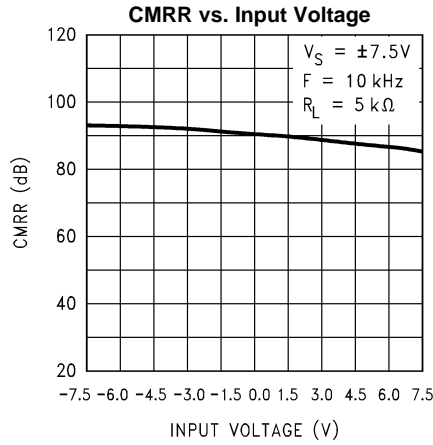


Figure 19.

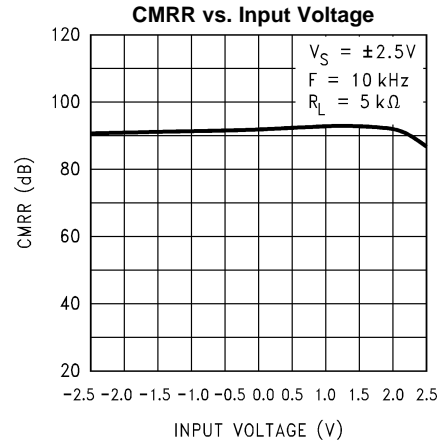


Figure 20.

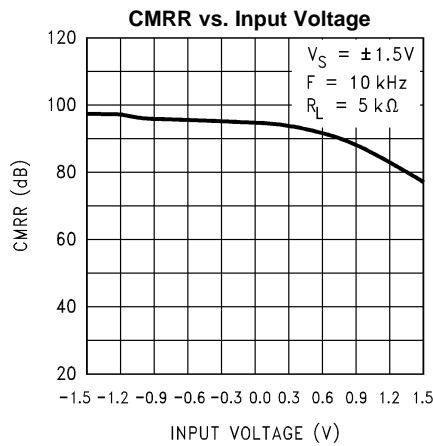


Figure 21.

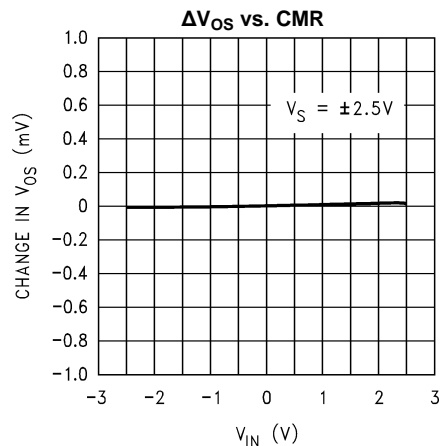


Figure 22.

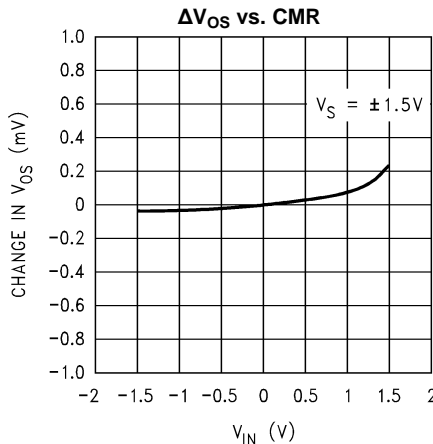


Figure 23.

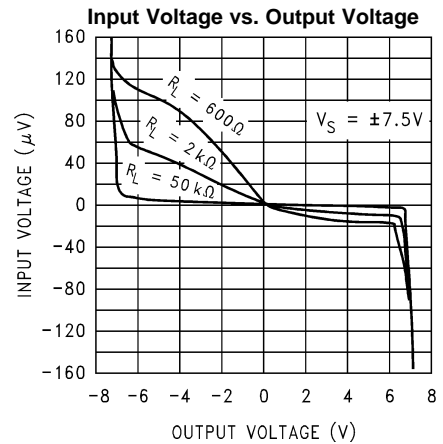


Figure 24.



Typical Performance Characteristics (continued)

$V_S = +15V$ , Single Supply,  $T_A = 25^\circ C$  unless otherwise specified

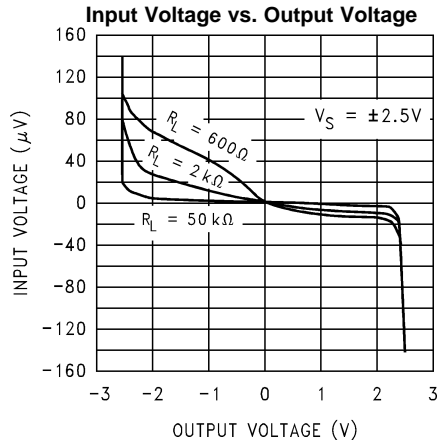


Figure 25.

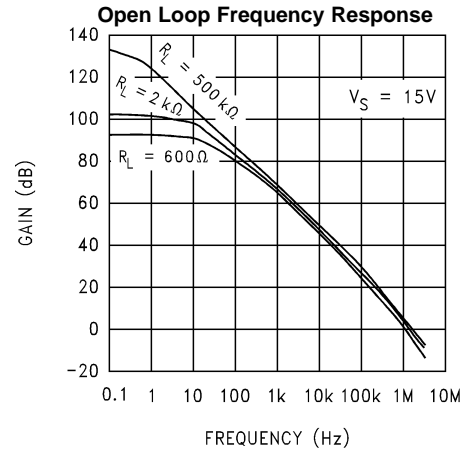


Figure 26.

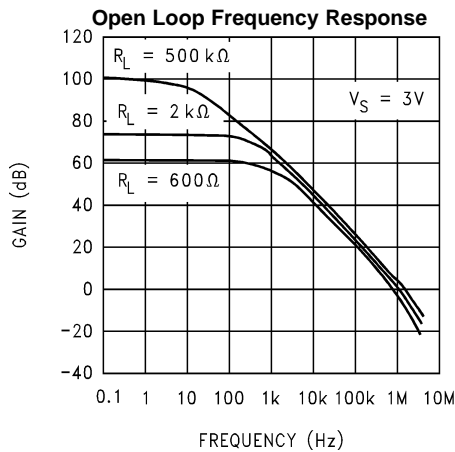


Figure 27.

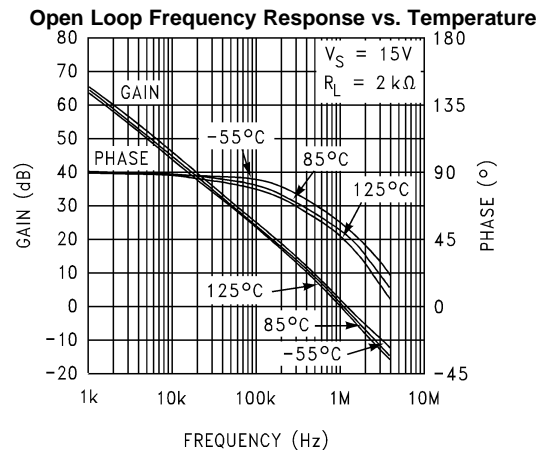


Figure 28.

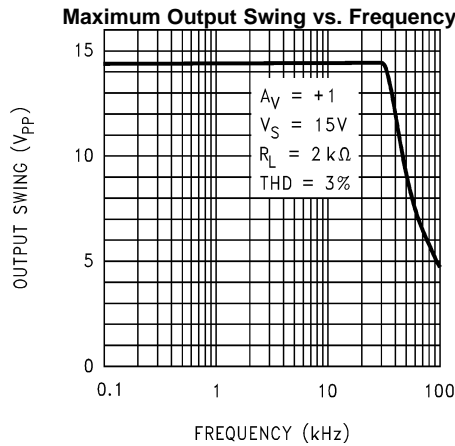


Figure 29.

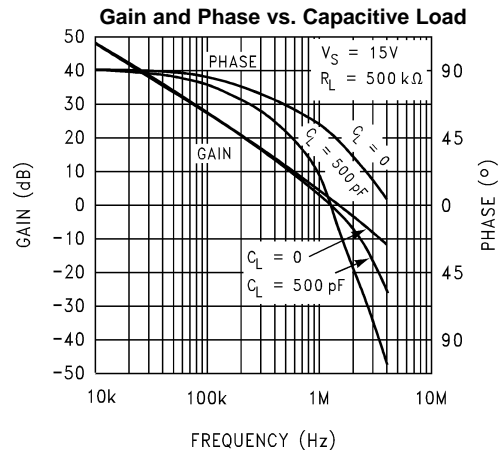


Figure 30.

**Typical Performance Characteristics (continued)**

$V_S = +15V$ , Single Supply,  $T_A = 25^\circ C$  unless otherwise specified

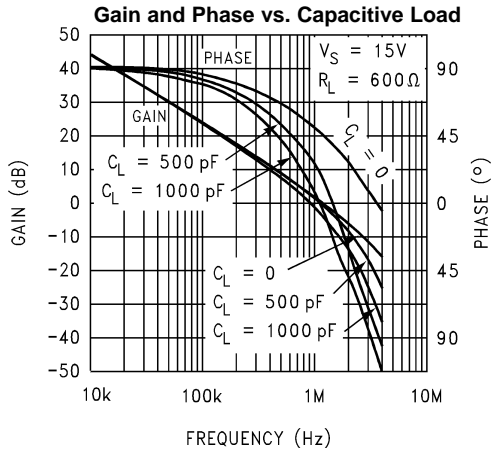


Figure 31.

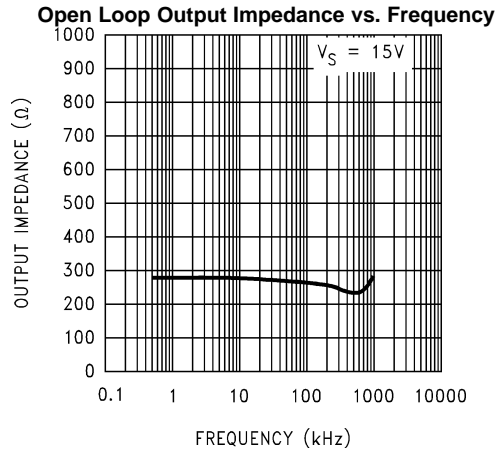


Figure 32.

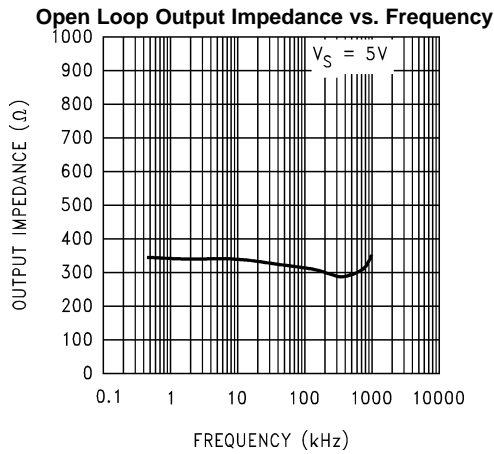


Figure 33.

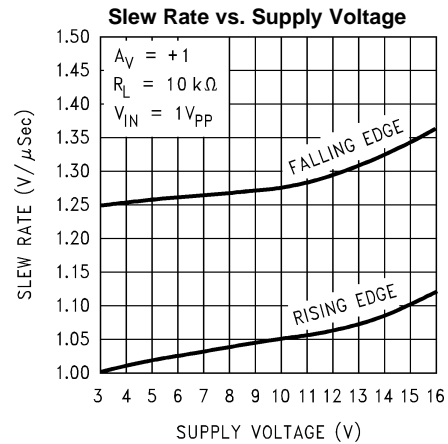


Figure 34.

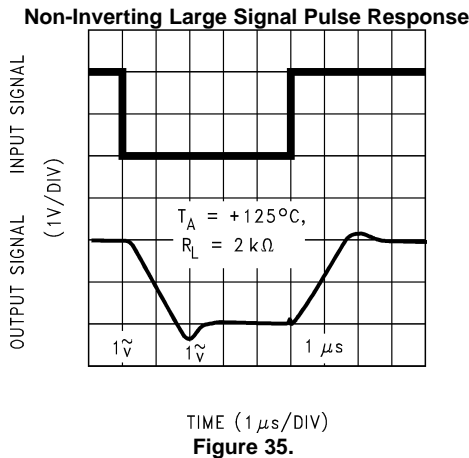


Figure 35.

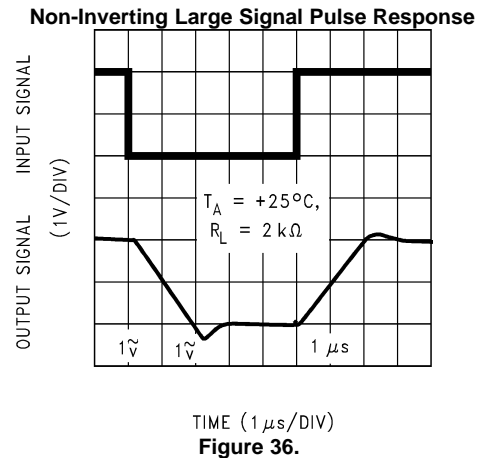
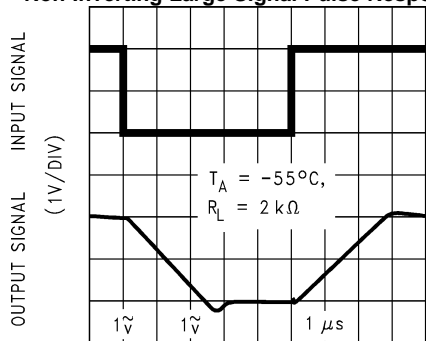


Figure 36.

Typical Performance Characteristics (continued)

$V_S = +15V$ , Single Supply,  $T_A = 25^\circ C$  unless otherwise specified

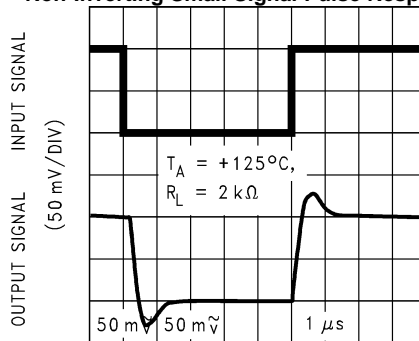
Non-Inverting Large Signal Pulse Response



TIME (1 µs/DIV)

Figure 37.

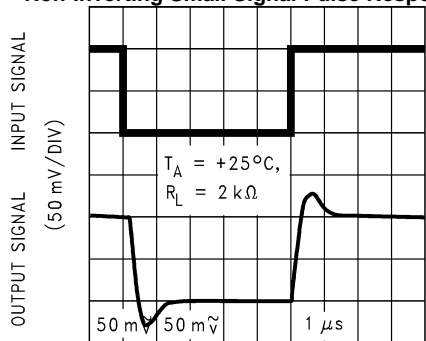
Non-Inverting Small Signal Pulse Response



TIME (1 µs/DIV)

Figure 38.

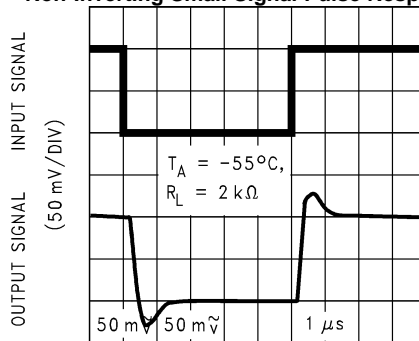
Non-Inverting Small Signal Pulse Response



TIME (1 µs/DIV)

Figure 39.

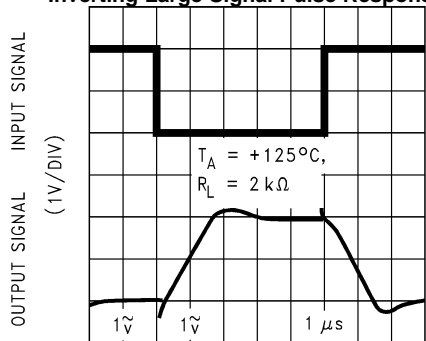
Non-Inverting Small Signal Pulse Response



TIME (1 µs/DIV)

Figure 40.

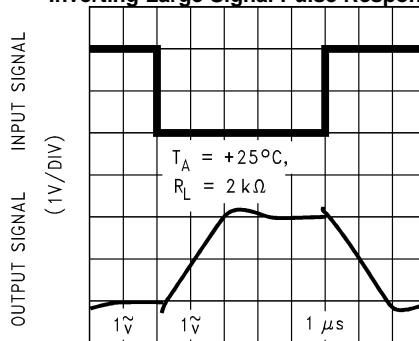
Inverting Large Signal Pulse Response



TIME (1 µs/DIV)

Figure 41.

Inverting Large Signal Pulse Response



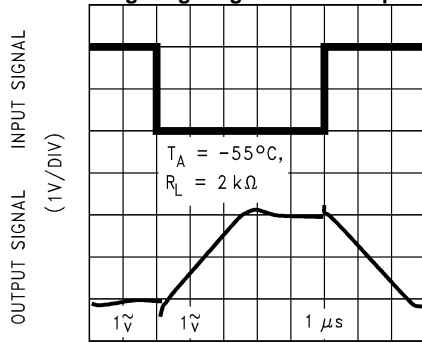
TIME (1 µs/DIV)

Figure 42.

**Typical Performance Characteristics (continued)**

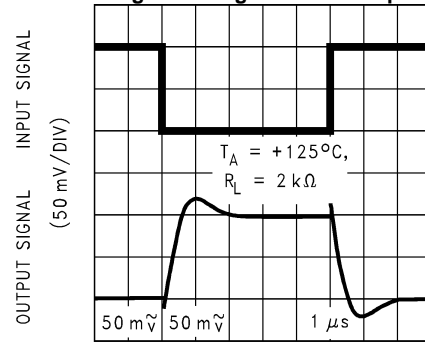
$V_S = +15V$ , Single Supply,  $T_A = 25^\circ C$  unless otherwise specified

**Inverting Large Signal Pulse Response**



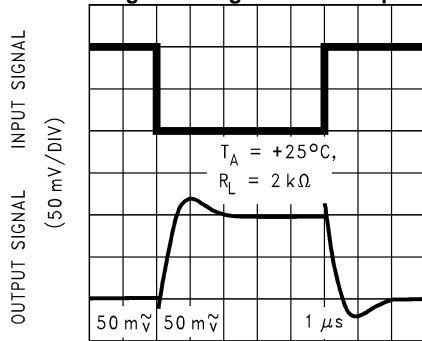
TIME ( $1\mu s/DIV$ )  
**Figure 43.**

**Inverting Small Signal Pulse Response**



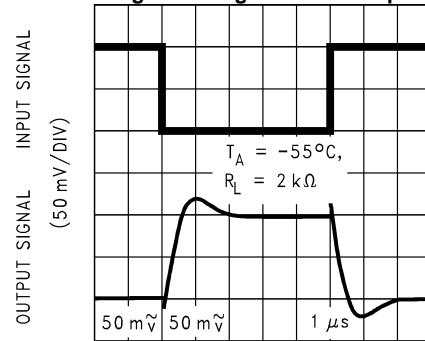
TIME ( $1\mu s/DIV$ )  
**Figure 44.**

**Inverting Small Signal Pulse Response**



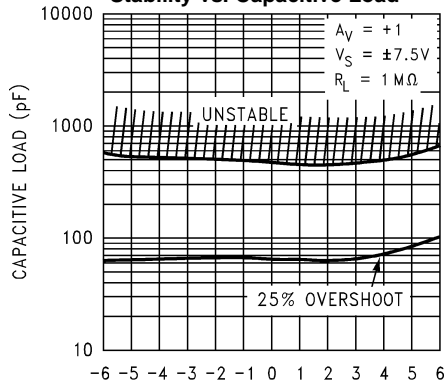
TIME ( $1\mu s/DIV$ )  
**Figure 45.**

**Inverting Small Signal Pulse Response**



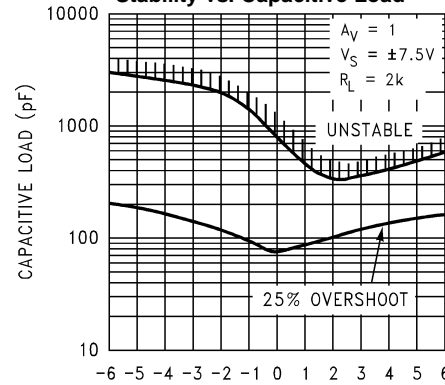
TIME ( $1\mu s/DIV$ )  
**Figure 46.**

**Stability vs. Capacitive Load**



$V_{OUT}$  (V)  
**Figure 47.**

**Stability vs. Capacitive Load**



$V_{OUT}$  (V)  
**Figure 48.**

Typical Performance Characteristics (continued)

$V_S = +15V$ , Single Supply,  $T_A = 25^\circ C$  unless otherwise specified

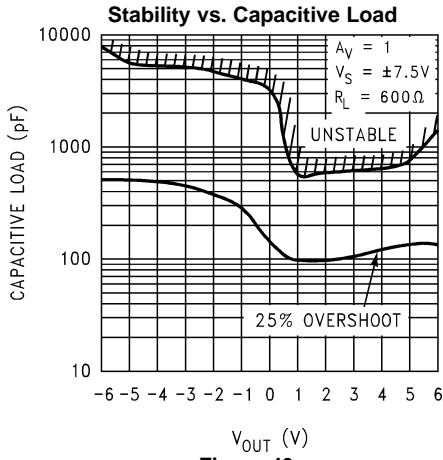


Figure 49.

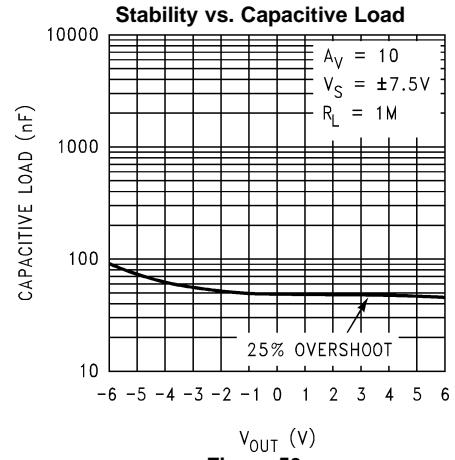


Figure 50.

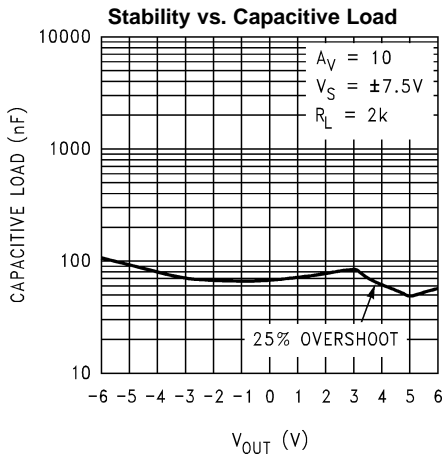


Figure 51.

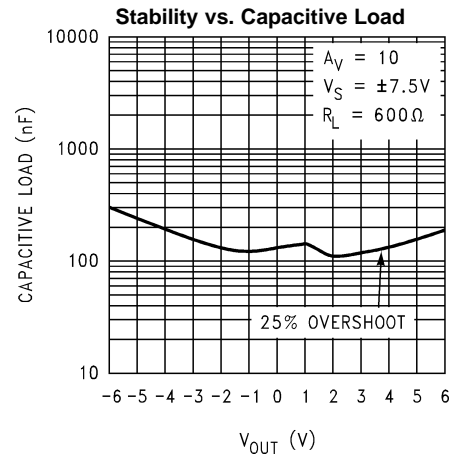


Figure 52.

## APPLICATION INFORMATION

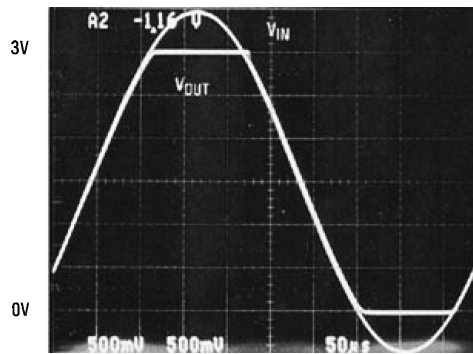
### AMPLIFIER TOPOLOGY

The LMC6482 incorporates specially designed wide-compliance range current mirrors and the body effect to extend input common mode range to each supply rail. Complementary paralleled differential input stages, like the type used in other CMOS and bipolar rail-to-rail input amplifiers, were not used because of their inherent accuracy problems due to CMRR, cross-over distortion, and open-loop gain variation.

The LMC6482's input stage design is complemented by an output stage capable of rail-to-rail output swing even when driving a large load. Rail-to-rail output swing is obtained by taking the output directly from the internal integrator instead of an output buffer stage.

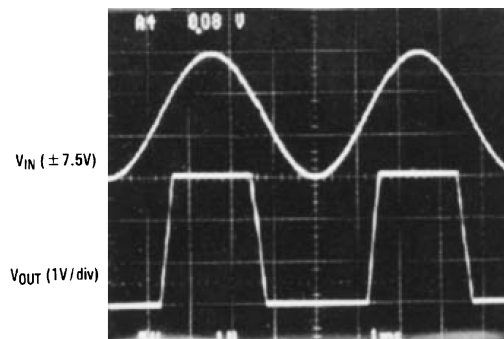
### INPUT COMMON-MODE VOLTAGE RANGE

Unlike Bi-FET amplifier designs, the LMC6482 does not exhibit phase inversion when an input voltage exceeds the negative supply voltage. [Figure 53](#) shows an input voltage exceeding both supplies with no resulting phase inversion on the output.



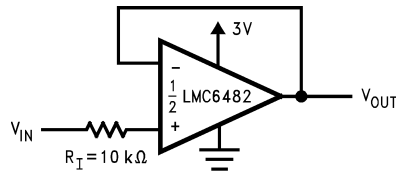
**Figure 53. An Input Voltage Signal Exceeds the LMC6482 Power Supply Voltages with No Output Phase Inversion**

The absolute maximum input voltage is 300mV beyond either supply rail at room temperature. Voltages greatly exceeding this absolute maximum rating, as in [Figure 54](#), can cause excessive current to flow in or out of the input pins possibly affecting reliability.



**Figure 54. A  $\pm 7.5\text{V}$  Input Signal Greatly Exceeds the 3V Supply in [Figure 55](#) Causing No Phase Inversion Due to  $R_i$**

Applications that exceed this rating must externally limit the maximum input current to  $\pm 5\text{mA}$  with an input resistor ( $R_i$ ) as shown in [Figure 55](#).



**Figure 55.  $R_T$  Input Current Protection for Voltages Exceeding the Supply Voltages**

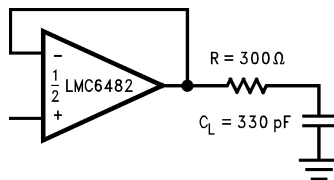
## RAIL-TO-RAIL OUTPUT

The approximated output resistance of the LMC6482 is  $180\Omega$  sourcing and  $130\Omega$  sinking at  $V_S = 3V$  and  $110\Omega$  sourcing and  $80\Omega$  sinking at  $V_S = 5V$ . Using the calculated output resistance, maximum output voltage swing can be estimated as a function of load.

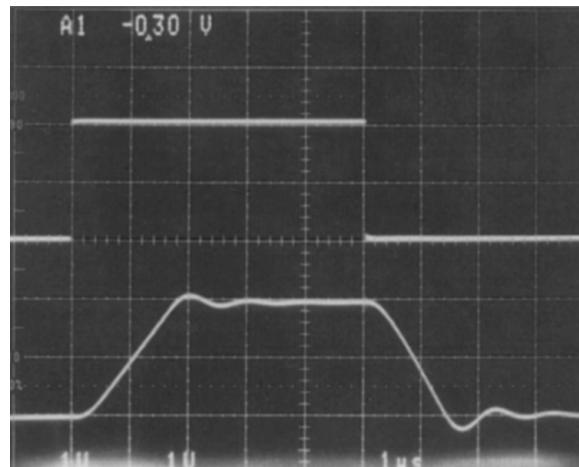
## CAPACITIVE LOAD TOLERANCE

The LMC6482 can typically directly drive a  $100pF$  load with  $V_S = 15V$  at unity gain without oscillating. The unity gain follower is the most sensitive configuration. Direct capacitive loading reduces the phase margin of op-amps. The combination of the op-amp's output impedance and the capacitive load induces phase lag. This results in either an underdamped pulse response or oscillation.

Capacitive load compensation can be accomplished using resistive isolation as shown in [Figure 56](#). This simple technique is useful for isolating the capacitive inputs of multiplexers and A/D converters.

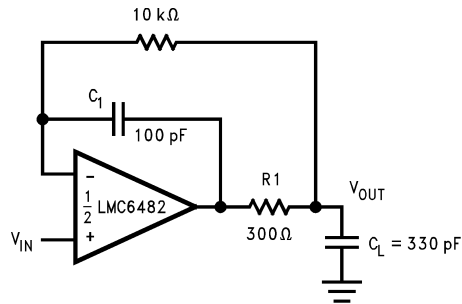


**Figure 56. Resistive Isolation of a  $330pF$  Capacitive Load**



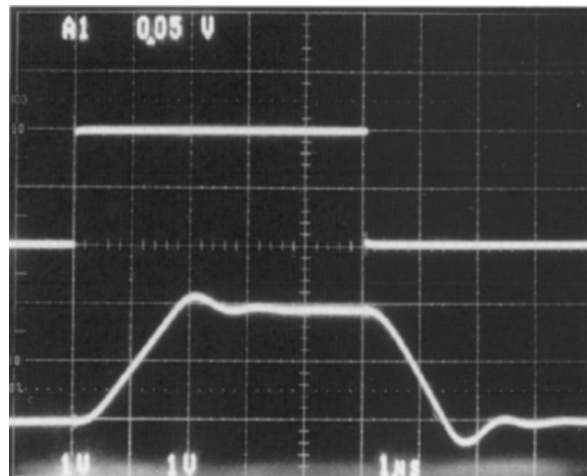
**Figure 57. Pulse Response of the LMC6482 Circuit in [Figure 56](#)**

Improved frequency response is achieved by indirectly driving capacitive loads, as shown in [Figure 58](#).



**Figure 58. LMC6482 Noninverting Amplifier, Compensated to Handle a 330pF Capacitive Load**

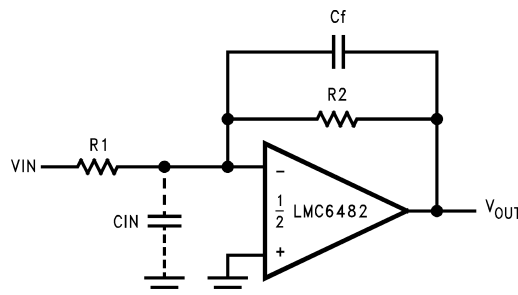
R1 and C1 serve to counteract the loss of phase margin by feeding forward the high frequency component of the output signal back to the amplifiers inverting input, thereby preserving phase margin in the overall feedback loop. The values of R1 and C1 are experimentally determined for the desired pulse response. The resulting pulse response can be seen in [Figure 59](#).



**Figure 59. Pulse Response of LMC6482 Circuit in [Figure 58](#)**

**COMPENSATING FOR INPUT CAPACITANCE**

It is quite common to use large values of feedback resistance with amplifiers that have ultra-low input current, like the LMC6482. Large feedback resistors can react with small values of input capacitance due to transducers, photodiodes, and circuits board parasitics to reduce phase margins.



**Figure 60. Canceling the Effect of Input Capacitance**



The effect of input capacitance can be compensated for by adding a feedback capacitor. The feedback capacitor (as in Figure 60),  $C_f$ , is first estimated by:

$$\frac{1}{2\pi R_1 C_{IN}} \geq \frac{1}{2\pi R_2 C_f} \quad (1)$$

or

$$R_1 C_i \leq R_2 C_f \quad (2)$$

which typically provides significant overcompensation.

Printed circuit board stray capacitance may be larger or smaller than that of a bread-board, so the actual optimum value for  $C_f$  may be different. The values of  $C_f$  should be checked on the actual circuit. (Refer to the LMC660 quad CMOS amplifier data sheet for a more detailed discussion.)

### PRINTED-CIRCUIT-BOARD LAYOUT FOR HIGH-IMPEDANCE WORK

It is generally recognized that any circuit which must operate with less than 1000pA of leakage current requires special layout of the PC board. When one wishes to take advantage of the ultra-low input current of the LMC6482, typically less than 20fA, it is essential to have an excellent layout. Fortunately, the techniques of obtaining low leakages are quite simple. First, the user must not ignore the surface leakage of the PC board, even though it may sometimes appear acceptably low, because under conditions of high humidity or dust or contamination, the surface leakage will be appreciable.

To minimize the effect of any surface leakage, lay out a ring of foil completely surrounding the LM6482's inputs and the terminals of capacitors, diodes, conductors, resistors, relay terminals, etc. connected to the op-amp's inputs, as in Figure 61. To have a significant effect, guard rings should be placed on both the top and bottom of the PC board. This PC foil must then be connected to a voltage which is at the same voltage as the amplifier inputs, since no leakage current can flow between two points at the same potential. For example, a PC board trace-to-pad resistance of  $10^{12}\Omega$ , which is normally considered a very large resistance, could leak 5pA if the trace were a 5V bus adjacent to the pad of the input. This would cause a 250 times degradation from the LMC6482's actual performance. However, if a guard ring is held within 5 mV of the inputs, then even a resistance of  $10^{11}\Omega$  would cause only 0.05pA of leakage current. See Figure 62 for typical connections of guard rings for standard op-amp configurations.

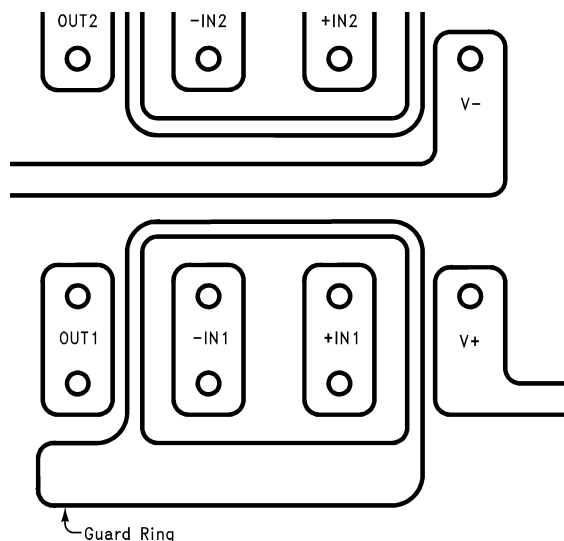
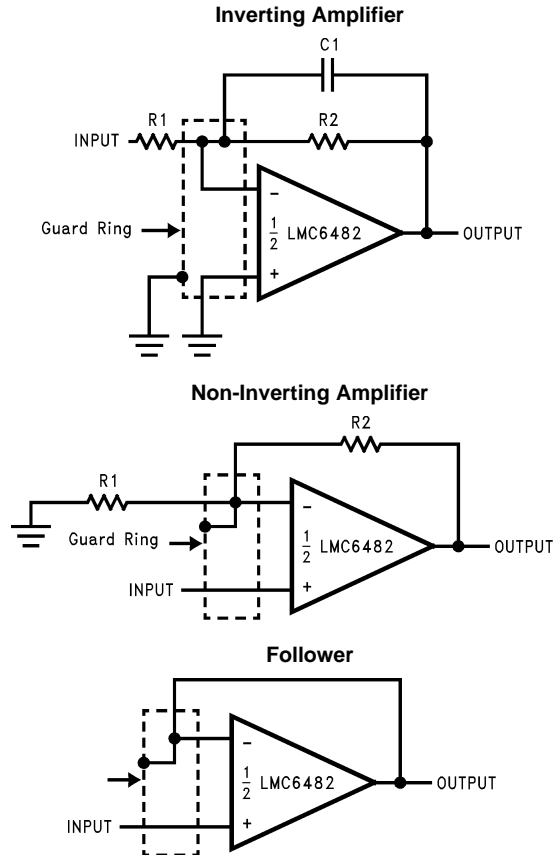
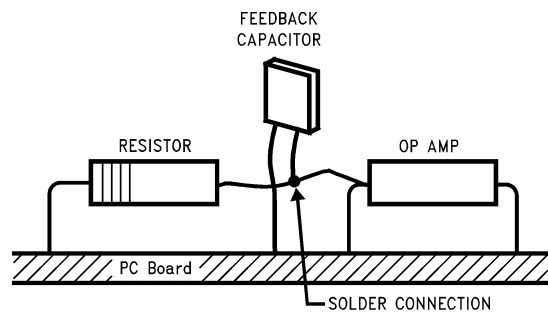


Figure 61. Example of Guard Ring in P.C. Board Layout



**Figure 62. Typical Connections of Guard Rings**

The designer should be aware that when it is inappropriate to lay out a PC board for the sake of just a few circuits, there is another technique which is even better than a guard ring on a PC board: Don't insert the amplifier's input pin into the board at all, but bend it up in the air and use only air as an insulator. Air is an excellent insulator. In this case you may have to forego some of the advantages of PC board construction, but the advantages are sometimes well worth the effort of using point-to-point up-in-the-air wiring. See [Figure 63](#).

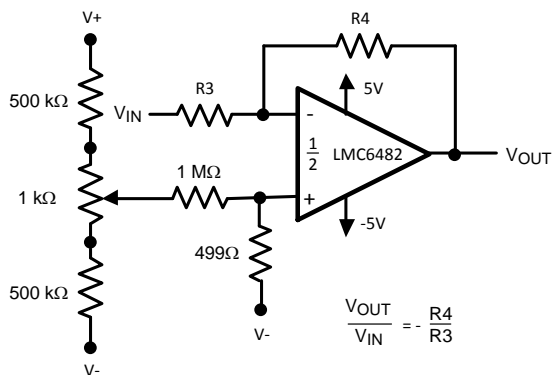


(Input pins are lifted out of PC board and soldered directly to components. All other pins connected to PC board.)

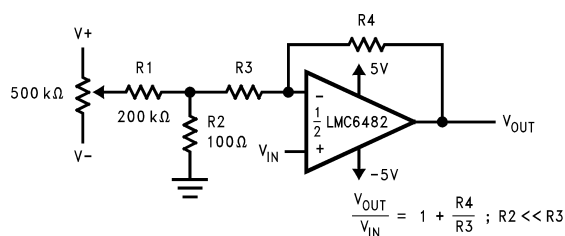
**Figure 63. Air Wiring**

## OFFSET VOLTAGE ADJUSTMENT

Offset voltage adjustment circuits are illustrated in Figure 64 Figure 65. Large value resistances and potentiometers are used to reduce power consumption while providing typically  $\pm 2.5\text{mV}$  of adjustment range, referred to the input, for both configurations with  $V_S = \pm 5\text{V}$ .



**Figure 64. Inverting Configuration  
Offset Voltage Adjustment**



**Figure 65. Non-Inverting Configuration  
Offset Voltage Adjustment**

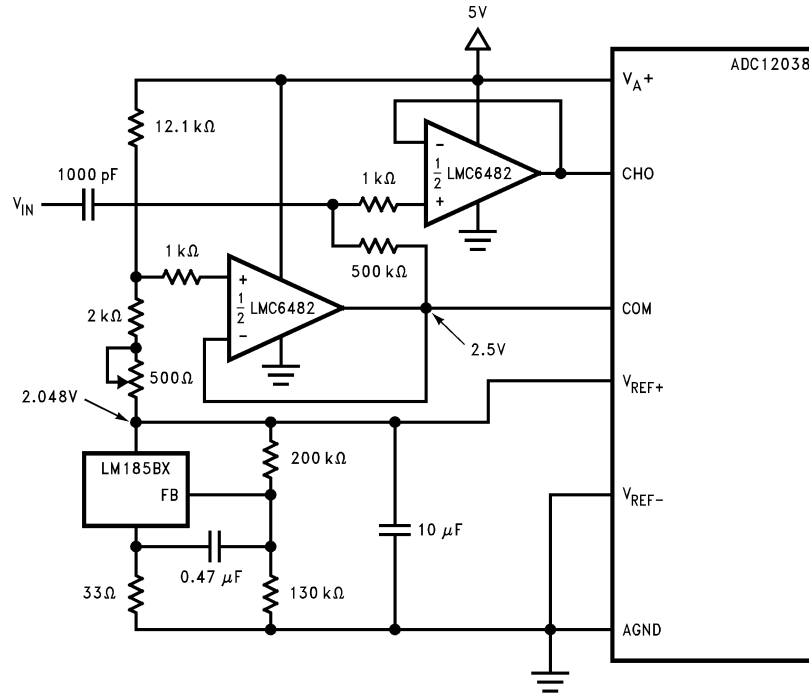
## UPGRADING APPLICATIONS

The LMC6484 quads and LMC6482 duals have industry standard pin outs to retrofit existing applications. System performance can be greatly increased by the LMC6482's features. The key benefit of designing in the LMC6482 is increased linear signal range. Most op-amps have limited input common mode ranges. Signals that exceed this range generate a non-linear output response that persists long after the input signal returns to the common mode range.

Linear signal range is vital in applications such as filters where signal peaking can exceed input common mode ranges resulting in output phase inversion or severe distortion.

## DATA ACQUISITION SYSTEMS

Low power, single supply data acquisition system solutions are provided by buffering the ADC12038 with the LMC6482 (Figure 66). Capable of using the full supply range, the LMC6482 does not require input signals to be scaled down to meet limited common mode voltage ranges. The LMC4282 CMRR of 82dB maintains integral linearity of a 12-bit data acquisition system to  $\pm 0.325$  LSB. Other rail-to-rail input amplifiers with only 50dB of CMRR will degrade the accuracy of the data acquisition system to only 8 bits.



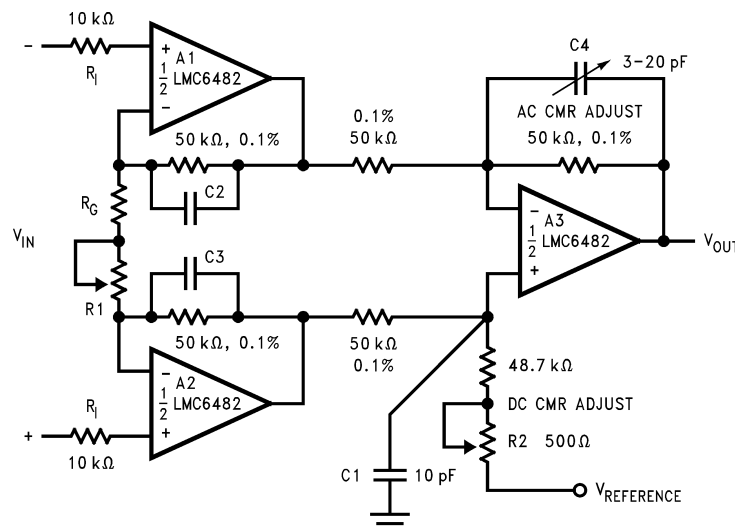
Operating from the same Supply Voltage, the LMC6482 buffers the ADC12038 maintaining excellent accuracy.

**Figure 66. Buffering the ADC12038 with the LMC6482**

## INSTRUMENTATION CIRCUITS

The LMC6482 has the high input impedance, large common-mode range and high CMRR needed for designing instrumentation circuits. Instrumentation circuits designed with the LMC6482 can reject a larger range of common-mode signals than most in-amps. This makes instrumentation circuits designed with the LMC6482 an excellent choice of noisy or industrial environments. Other applications that benefit from these features include analytic medical instruments, magnetic field detectors, gas detectors, and silicon-based transducers.

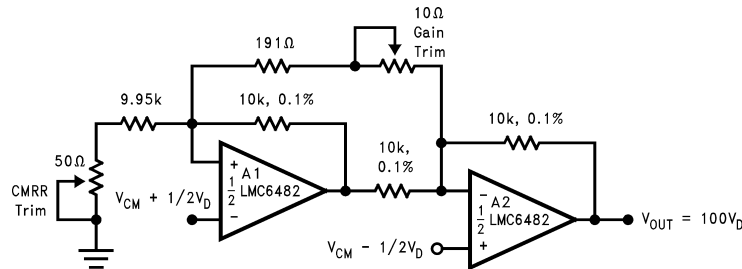
A small valued potentiometer is used in series with  $R_g$  to set the differential gain of the 3 op-amp instrumentation circuit in [Figure 67](#). This combination is used instead of one large valued potentiometer to increase gain trim accuracy and reduce error due to vibration.



**Figure 67. Low Power 3 Op-Amp Instrumentation Amplifier**

A 2 op-amp instrumentation amplifier designed for a gain of 100 is shown in Figure 68. Low sensitivity trimming is made for offset voltage, CMRR and gain. Low cost and low power consumption are the main advantages of this two op-amp circuit.

Higher frequency and larger common-mode range applications are best facilitated by a three op-amp instrumentation amplifier.



**Figure 68. Low-Power Two-Op-Amp Instrumentation Amplifier**

**SPICE MACROMODEL**

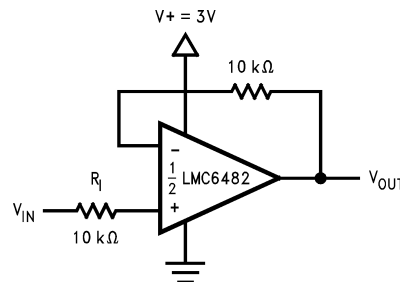
A spice macromodel is available for the LMC6482. This model includes accurate simulation of:

- Input common-mode voltage range
- Frequency and transient response
- GBW dependence on loading conditions
- Quiescent and dynamic supply current
- Output swing dependence on loading conditions

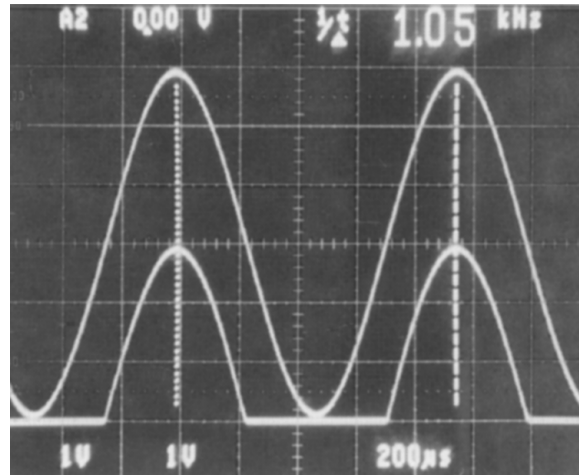
and many more characteristics as listed on the macromodel disk.

Contact your local Texas Instruments sales office to obtain an operational amplifier spice model library disk.

**Typical Single-Supply Applications**

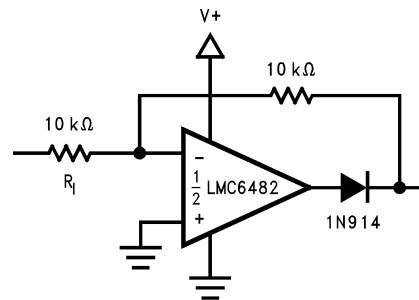


**Figure 69. Half-Wave Rectifier with Input Current Protection (RI)**

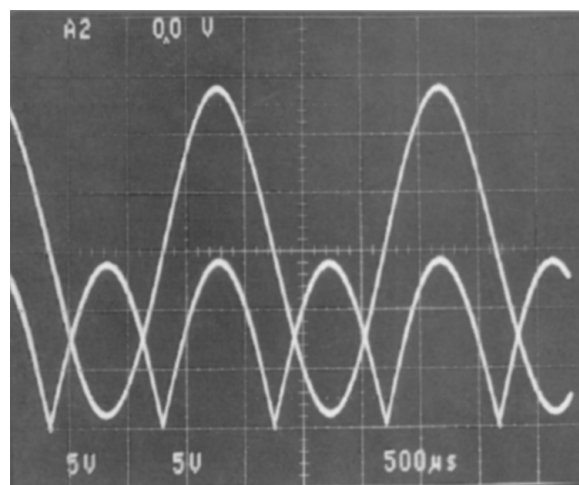


**Figure 70. Half-Wave Rectifier Waveform**

The circuit in [Figure 69](#) uses a single supply to half wave rectify a sinusoid centered about ground.  $R_i$  limits current into the amplifier caused by the input voltage exceeding the supply voltage. Full wave rectification is provided by the circuit in [Figure 71](#).



**Figure 71. Full Wave Rectifier with Input Current Protection ( $R_i$ )**



**Figure 72. Full Wave Rectifier Waveform**

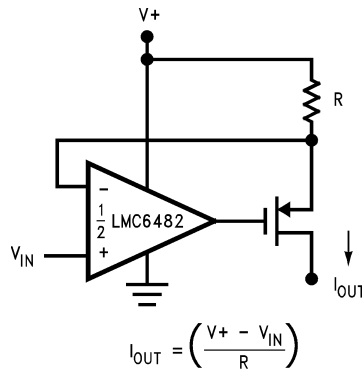


Figure 73. Large Compliance Range Current Source

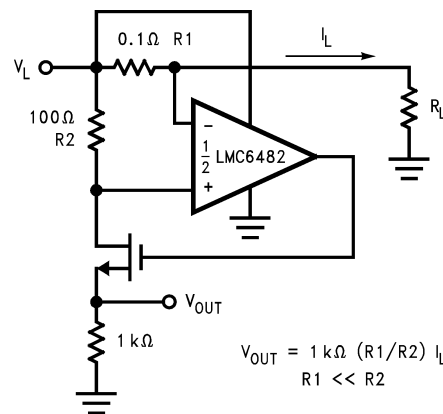


Figure 74. Positive Supply Current Sense

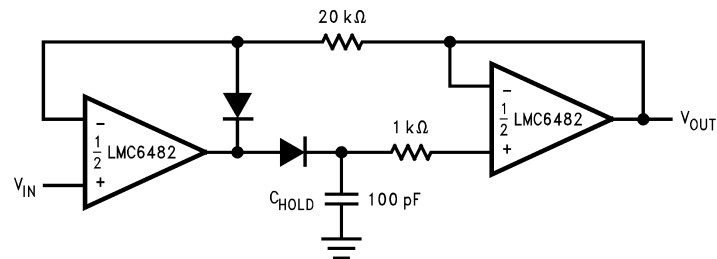


Figure 75. Low Voltage Peak Detector with Rail-to-Rail Peak Capture Range

In Figure 75 dielectric absorption and leakage is minimized by using a polystyrene or polyethylene hold capacitor. The droop rate is primarily determined by the value of  $C_H$  and diode leakage current. The ultra-low input current of the LMC6482 has a negligible effect on droop.

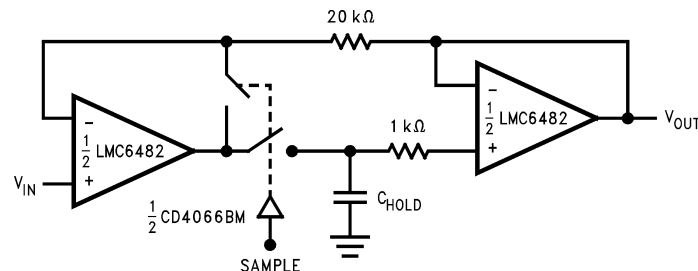
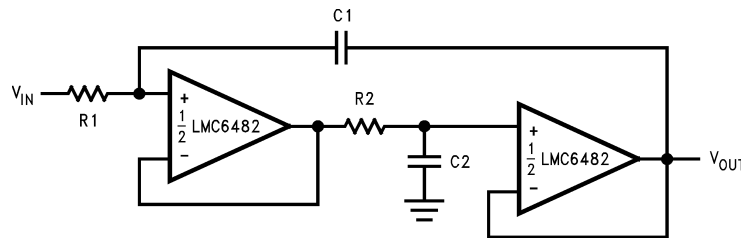


Figure 76. Rail-to-Rail Sample and Hold

The LMC6482's high CMRR (82dB) allows excellent accuracy throughout the circuit's rail-to-rail dynamic capture range.



$$R1 = R2, C1 = C2; f = \frac{1}{2\pi R1 C1}; DF = \frac{1}{2} \sqrt{\frac{C2}{C1}} \sqrt{\frac{R2}{R1}}$$

**Figure 77. Rail-to-Rail Single Supply Low Pass Filter**

The low pass filter circuit in [Figure 77](#) can be used as an anti-aliasing filter with the same voltage supply as the A/D converter.

Filter designs can also take advantage of the LMC6482 ultra-low input current. The ultra-low input current yields negligible offset error even when large value resistors are used. This in turn allows the use of smaller valued capacitors which take less board space and cost less.



**REVISION HISTORY**

<b>Released</b>	<b>Revision</b>	<b>Section</b>	<b>Changes</b>
12/08/2010	A	New Release, Corporate format	1 MDS data sheet converted into one Corp. data sheet format. MNLMC6482AM-X Rev 0A0 will be archived.
03/27/2013	A	All	Changed layout of National Data Sheet to TI format.

**PACKAGING INFORMATION**

Orderable part number	Status (1)	Material type (2)	Package   Pins	Package qty   Carrier	RoHS (3)	Lead finish/ Ball material (4)	MSL rating/ Peak reflow (5)	Op temp (°C)	Part marking (6)
<a href="#">LMC6482AMJ/883</a>	Active	Production	CDIP (NAB)   8	40   TUBE	No	Call TI	Level-1-NA-UNLIM	-55 to 125	LMC6482AMJ88 5962-94534 01MPA Q ACO 01MPA Q >T
LMC6482AMJ/883.A	Active	Production	CDIP (NAB)   8	40   TUBE	No	Call TI	Level-1-NA-UNLIM	-55 to 125	LMC6482AMJ88 5962-94534 01MPA Q ACO 01MPA Q >T
LMC6482M MD8	Active	Production	DIESALE (Y)   0	169   JEDEC TRAY (5+1)	Yes	Call TI	Level-1-NA-UNLIM	-55 to 125	
LMC6482M-MD8.A	Active	Production	DIESALE (Y)   0	169   JEDEC TRAY (5+1)	Yes	Call TI	Level-1-NA-UNLIM	-55 to 125	

(1) **Status:** For more details on status, see our [product life cycle](#).

(2) **Material type:** When designated, preproduction parts are prototypes/experimental devices, and are not yet approved or released for full production. Testing and final process, including without limitation quality assurance, reliability performance testing, and/or process qualification, may not yet be complete, and this item is subject to further changes or possible discontinuation. If available for ordering, purchases will be subject to an additional waiver at checkout, and are intended for early internal evaluation purposes only. These items are sold without warranties of any kind.

(3) **RoHS values:** Yes, No, RoHS Exempt. See the [TI RoHS Statement](#) for additional information and value definition.

(4) **Lead finish/Ball material:** Parts may have multiple material finish options. Finish options are separated by a vertical ruled line. Lead finish/Ball material values may wrap to two lines if the finish value exceeds the maximum column width.

(5) **MSL rating/Peak reflow:** The moisture sensitivity level ratings and peak solder (reflow) temperatures. In the event that a part has multiple moisture sensitivity ratings, only the lowest level per JEDEC standards is shown. Refer to the shipping label for the actual reflow temperature that will be used to mount the part to the printed circuit board.

(6) **Part marking:** There may be an additional marking, which relates to the logo, the lot trace code information, or the environmental category of the part.

Multiple part markings will be inside parentheses. Only one part marking contained in parentheses and separated by a "-" will appear on a part. If a line is indented then it is a continuation of the previous line and the two combined represent the entire part marking for that device.

**Important Information and Disclaimer:** The information provided on this page represents TI's knowledge and belief as of the date that it is provided. TI bases its knowledge and belief on information provided by third parties, and makes no representation or warranty as to the accuracy of such information. Efforts are underway to better integrate information from third parties. TI has taken and continues to take reasonable steps to provide representative

and accurate information but may not have conducted destructive testing or chemical analysis on incoming materials and chemicals. TI and TI suppliers consider certain information to be proprietary, and thus CAS numbers and other limited information may not be available for release.

In no event shall TI's liability arising out of such information exceed the total purchase price of the TI part(s) at issue in this document sold by TI to Customer on an annual basis.

**TUBE**


\*All dimensions are nominal

Device	Package Name	Package Type	Pins	SPQ	L (mm)	W (mm)	T (μm)	B (mm)
LMC6482AMJ/883	NAB	CDIP	8	40	506.98	15.24	13440	NA
LMC6482AMJ/883.A	NAB	CDIP	8	40	506.98	15.24	13440	NA

NAB0008A



CONTROLLING DIMENSION IS INCH  
VALUES IN [ ] ARE MILLIMETERS



J08A (Rev M)

## IMPORTANT NOTICE AND DISCLAIMER

TI PROVIDES TECHNICAL AND RELIABILITY DATA (INCLUDING DATA SHEETS), DESIGN RESOURCES (INCLUDING REFERENCE DESIGNS), APPLICATION OR OTHER DESIGN ADVICE, WEB TOOLS, SAFETY INFORMATION, AND OTHER RESOURCES "AS IS" AND WITH ALL FAULTS, AND DISCLAIMS ALL WARRANTIES, EXPRESS AND IMPLIED, INCLUDING WITHOUT LIMITATION ANY IMPLIED WARRANTIES OF MERCHANTABILITY, FITNESS FOR A PARTICULAR PURPOSE OR NON-INFRINGEMENT OF THIRD PARTY INTELLECTUAL PROPERTY RIGHTS.

These resources are intended for skilled developers designing with TI products. You are solely responsible for (1) selecting the appropriate TI products for your application, (2) designing, validating and testing your application, and (3) ensuring your application meets applicable standards, and any other safety, security, regulatory or other requirements.

These resources are subject to change without notice. TI grants you permission to use these resources only for development of an application that uses the TI products described in the resource. Other reproduction and display of these resources is prohibited. No license is granted to any other TI intellectual property right or to any third party intellectual property right. TI disclaims responsibility for, and you will fully indemnify TI and its representatives against, any claims, damages, costs, losses, and liabilities arising out of your use of these resources.

TI's products are provided subject to [TI's Terms of Sale](#) or other applicable terms available either on [ti.com](https://www.ti.com) or provided in conjunction with such TI products. TI's provision of these resources does not expand or otherwise alter TI's applicable warranties or warranty disclaimers for TI products.

TI objects to and rejects any additional or different terms you may have proposed.

Mailing Address: Texas Instruments, Post Office Box 655303, Dallas, Texas 75265  
Copyright © 2025, Texas Instruments Incorporated