

# DRV5056 Unipolar Ratiometric Linear Hall-Effect Sensor

## 1 Features

- Unipolar linear hall effect magnetic sensor
- Operates from 3.3V and 5V power supplies
- Analog output with 0.6V quiescent offset:
  - Maximizes voltage swing for high accuracy
- Magnetic sensitivity options (at  $V_{CC} = 5V$ ):
  - A1/Z1: 200mV/mT, 20mT range
  - A2/Z2: 100mV/mT, 39mT range
  - A3/Z3: 50mV/mT, 79mT range
  - A4/Z4: 25mV/mT, 158mT range
  - A6: 100mV/mT, 39mT range
  - A8: 66.6mV/mT, 64mT range
- Fast 20kHz sensing bandwidth
- Low-noise output with  $\pm 1mA$  drive
- Compensation for magnet temperature drift for A1/A2/A3/A4/A6/A8 versions and None for the Z1/Z2/Z3/Z4 versions
- Standard industry packages:
  - Surface-mount SOT-23
  - Through-hole TO-92

## 2 Applications

- Precise position sensing
- Industrial automation and robotics
- Home appliances
- Gamepads, pedals, keyboards, triggers
- Height leveling, tilt and weight measurement
- Fluid flow rate measurement
- Medical devices
- Current sensing

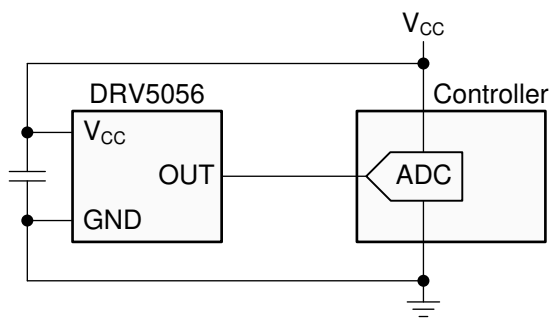

Typical Schematic

## 3 Description

The DRV5056 is a linear Hall-effect sensor that responds proportionally to flux density of a magnetic south pole. The device can be used for accurate position sensing in a wide range of applications.

Featuring a unipolar magnetic response, the analog output drives 0.6V when no magnetic field is present, and increases when a south magnetic pole is applied. This response maximizes the output dynamic range in applications that sense one magnetic pole. Multiple sensitivity options further maximize the output swing based on the required sensing range.

The device operates from 3.3V or 5V power supplies. Magnetic flux perpendicular to the top of the package is sensed, and the two package options provide different sensing directions.

The device uses a ratiometric architecture that can minimize error from  $V_{CC}$  tolerance when the external analog-to-digital converter (ADC) uses the same  $V_{CC}$  for the reference. Additionally, the device features magnet temperature compensation to counteract how magnets drift for linear performance across a wide  $-40^{\circ}C$  to  $+125^{\circ}C$  temperature range. Device options for no temperature compensation of magnet drift are also available.

### Package Information

PART NUMBER	PACKAGE <sup>(1)</sup>	PACKAGE SIZE <sup>(2)</sup>
DRV5056	DBZ (SOT-23, 3)	2.92mm × 2.37mm
	LPG (TO-92, 3)	4.00mm × 1.52mm

- (1) For all available packages, see the package option addendum at the end of the data sheet.
- (2) The package size (length × width) is a nominal value and includes pins, where applicable.

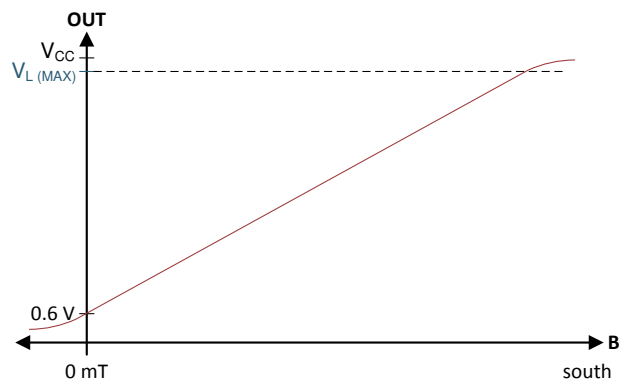

Magnetic Response



## Table of Contents

<b>1 Features</b> .....	<b>1</b>	<b>7 Application and Implementation</b> .....	<b>16</b>
<b>2 Applications</b> .....	<b>1</b>	7.1 Application Information.....	16
<b>3 Description</b> .....	<b>1</b>	7.2 Typical Application.....	17
<b>4 Pin Configuration and Functions</b> .....	<b>3</b>	7.3 Best System Practices.....	19
<b>5 Specifications</b> .....	<b>4</b>	7.4 Power Supply Recommendations.....	21
5.1 Absolute Maximum Ratings.....	4	7.5 Layout.....	21
5.2 ESD Ratings.....	4	<b>8 Device and Documentation Support</b> .....	<b>22</b>
5.3 Recommended Operating Conditions.....	4	8.1 Documentation Support.....	22
5.4 Thermal Information.....	4	8.2 Receiving Notification of Documentation Updates....	22
5.5 Electrical Characteristics.....	5	8.3 Support Resources.....	22
5.6 Magnetic Characteristics.....	5	8.4 Trademarks.....	22
5.7 Typical Characteristics.....	6	8.5 Electrostatic Discharge Caution.....	22
<b>6 Detailed Description</b> .....	<b>11</b>	8.6 Glossary.....	22
6.1 Overview.....	11	<b>9 Revision History</b> .....	<b>22</b>
6.2 Functional Block Diagram.....	11	<b>10 Mechanical, Packaging, and Orderable Information</b> .....	<b>23</b>
6.3 Feature Description.....	11		
6.4 Device Functional Modes.....	15		

## 4 Pin Configuration and Functions

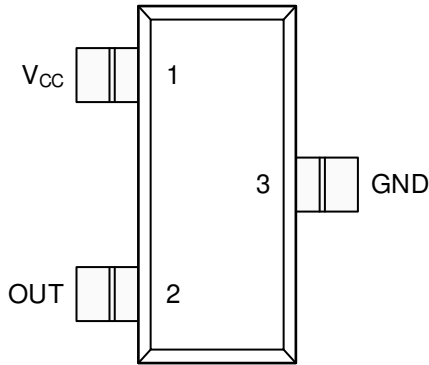

**Figure 4-1. DBZ Package 3-Pin SOT-23 Top View**

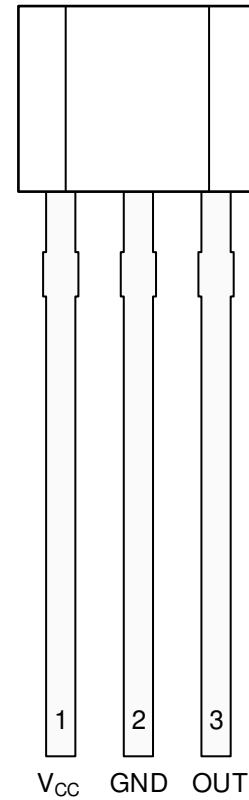

**Figure 4-2. LPG Package 3-Pin TO-92 Top View**

**Table 4-1. Pin Functions**

NAME	PIN		TYPE	DESCRIPTION
	SOT-23	TO-92		
GND	3	2	Ground	Ground reference
OUT	2	3	Output	Analog output
V <sub>CC</sub>	1	1	Power	Power supply. TI recommends connecting this pin to a ceramic capacitor to ground with a value of at least 0.1µF.

## 5 Specifications

### 5.1 Absolute Maximum Ratings

over operating free-air temperature range (unless otherwise noted)<sup>(1)</sup>

		MIN	MAX	UNIT
Power supply voltage	$V_{CC}$	-0.3	7	V
Output voltage	OUT	-0.3	$V_{CC} + 0.3$	V
Magnetic flux density, $B_{MAX}$		Unlimited		T
Operating junction temperature, $T_J$		-40	150	°C
Storage temperature, $T_{stg}$		-65	150	°C

- (1) Operation outside the Absolute Maximum Ratings may cause permanent device damage. Absolute Maximum Ratings do not imply functional operation of the device at these or any other conditions beyond those listed under Recommended Operating Conditions. If used outside the Recommended Operating Conditions but within the Absolute Maximum Ratings, the device may not be fully functional, and this may affect device reliability, functionality, performance, and shorten the device lifetime.

### 5.2 ESD Ratings

			VALUE	UNIT
$V_{(ESD)}$	Electrostatic discharge	Human-body model (HBM), per ANSI/ESDA/JEDEC JS-001 <sup>(1)</sup>	±2500	V
		Charged-device model (CDM), per JEDEC specification JESD22-C101 <sup>(2)</sup>	±750	

- (1) JEDEC document JEP155 states that 500-V HBM allows safe manufacturing with a standard ESD control process.  
 (2) JEDEC document JEP157 states that 250-V CDM allows safe manufacturing with a standard ESD control process.

### 5.3 Recommended Operating Conditions

over operating free-air temperature range (unless otherwise noted)

		MIN	MAX	UNIT
$V_{CC}$	Power supply voltage <sup>(1)</sup>	3	3.6	V
		4.5	5.5	
$I_O$	Output continuous current	-1	1	mA
$T_A$	A1/Z1-A4/Z4, A8 versions operating ambient temperature <sup>(2)</sup>	-40	125	°C
$T_A$	A6 version operating ambient temperature <sup>(2)</sup>	0	85	°C

- (1) There are two isolated operating  $V_{CC}$  ranges. For more information see the [Section 6.3.5](#) section.  
 (2) Power dissipation and thermal limits must be observed.

### 5.4 Thermal Information

THERMAL METRIC <sup>(1)</sup>		DRV5056		UNIT
		SOT-23 (DBZ)	TO-92 (LPG)	
		3 PINS	3 PINS	
$R_{\theta JA}$	Junction-to-ambient thermal resistance	170	121	°C/W
$R_{\theta JC(top)}$	Junction-to-case (top) thermal resistance	66	67	°C/W
$R_{\theta JB}$	Junction-to-board thermal resistance	49	97	°C/W
$Y_{JT}$	Junction-to-top characterization parameter	1.7	7.6	°C/W
$Y_{JB}$	Junction-to-board characterization parameter	48	97	°C/W

- (1) For more information about traditional and new thermal metrics, see the [Semiconductor and IC Package Thermal Metrics](#) application report.

## 5.5 Electrical Characteristics

for  $V_{CC} = 3\text{ V to }3.63\text{ V}$  and  $4.5\text{ V to }5.5\text{ V}$ , over operating free-air temperature range (unless otherwise noted)

PARAMETER		TEST CONDITIONS <sup>(1)</sup>		MIN	TYP	MAX	UNIT
$I_{CC}$	Operating supply current				6	10	mA
$t_{ON}$	Power-on time (see <a href="#">Power-On Time</a> )	B = 0 mT, no load on OUT			150	300	$\mu\text{s}$
$f_{BW}$	Sensing bandwidth				20		kHz
$t_d$	Propagation delay time	From change in B to change in OUT			10		$\mu\text{s}$
$B_{ND}$	Input-referred RMS noise density	$V_{CC} = 5\text{ V}$			130		nT/ $\sqrt{\text{Hz}}$
		$V_{CC} = 3.3\text{ V}$			215		
$B_N$	Input-referred noise	$B_{ND} \times 6.6 \times \sqrt{20\text{ kHz}}$	$V_{CC} = 5\text{ V}$		0.12		mT <sub>PP</sub>
			$V_{CC} = 3.3\text{ V}$		0.2		
$V_N$	Output-referred noise <sup>(2)</sup>	$B_N \times S$	DRV5056A1/Z1		24		mV <sub>PP</sub>
			DRV5056A2/Z2, DRV5056A6		12		
			DRV5056A3/Z3		6		
			DRV5056A4/Z4		3		
			DRV5056A8		4		mV <sub>PP</sub>

(1) B is the applied magnetic flux density.

(2)  $V_N$  describes voltage noise on the device output. If the full device bandwidth is not needed, noise can be reduced with an RC filter.

## 5.6 Magnetic Characteristics

for  $V_{CC} = 3\text{ V to }3.63\text{ V}$  and  $4.5\text{ V to }5.5\text{ V}$ , over operating free-air temperature range (unless otherwise noted)

PARAMETER		TEST CONDITIONS <sup>(1)</sup>		MIN	TYP	MAX	UNIT
$V_Q$	Quiescent voltage	B = 0 mT, $T_A = 25^\circ\text{C}$	DRV5056A1/Z1	0.535	0.6	0.665	V
			DRV5056A2/Z2, DRV5056A6	0.54	0.6	0.66	
			DRV5056A3/Z3, DRV5056A4/Z4	0.55	0.6	0.65	
			DRV5056A8	0.55	0.6	0.65	
$V_{Q\Delta T}$	Quiescent voltage temperature drift	B = 0 mT, $T_A = -40^\circ\text{C to }125^\circ\text{C}$ versus $25^\circ\text{C}$	$V_{CC} = 5\text{ V}$		0.08		V
			$V_{CC} = 3.3\text{ V}$		0.04		
$V_{Q\Delta T}$	Quiescent voltage temperature drift	B = 0 mT, $T_A = -40^\circ\text{C to }125^\circ\text{C}$ versus $25^\circ\text{C}$	DRV5056A8		0		V
$V_{Q\Delta L}$	Quiescent voltage lifetime drift	High-temperature operating stress for 1000 hours		< 0.5%			
S	Sensitivity	$V_{CC} = 5\text{ V},$ $T_A = 25^\circ\text{C}$	DRV5056A1/Z1	190	200	210	mV/mT
			DRV5056A2/Z2, DRV5056A6	95	100	105	
			DRV5056A3/Z3	47.5	50	52.5	
			DRV5056A4/Z4	23.8	25	26.2	
			DRV5056A8	63.3	66.6	69.9	
		$V_{CC} = 3.3\text{ V},$ $T_A = 25^\circ\text{C}$	DRV5056A1/Z1	114	120	126	
			DRV5056A2/Z2, DRV5056A6	57	60	63	
			DRV5056A3/Z3	28.5	30	31.5	
			DRV5056A4/Z4	14.3	15	15.8	
			DRV5056A8	38.0	40	42	

for  $V_{CC} = 3\text{ V}$  to  $3.63\text{ V}$  and  $4.5\text{ V}$  to  $5.5\text{ V}$ , over operating free-air temperature range (unless otherwise noted)

PARAMETER		TEST CONDITIONS <sup>(1)</sup>		MIN	TYP	MAX	UNIT
B <sub>L</sub>	Linear magnetic sensing range <sup>(2)</sup>	$V_{CC} = 5\text{ V}$ , $T_A = 25^\circ\text{C}$	DRV5056A1/Z1	20			mT
			DRV5056A2/Z2, DRV5056A6	39			
			DRV5056A3/Z3	79			
			DRV5056A4/Z4	158			
			DRV5056A8	64			
		$V_{CC} = 3.3\text{ V}$ , $T_A = 25^\circ\text{C}$	DRV5056A1/Z1	19			
			DRV5056A2/Z2, DRV5056A6	39			
			DRV5056A3/Z3	78			
			DRV5056A4/Z4	155			
			DRV5056A8	65			
V <sub>L</sub>	Linear range of output voltage <sup>(3)</sup>		$V_Q$		$V_{CC} - 0.2$	V	
S <sub>TC</sub>	Sensitivity temperature compensation for magnets <sup>(4)</sup>	DRV5056A6	0.05	0.12	0.19	%/°C	
		DRV5056A1, DRV5056A2, DRV5056A3, DRV5056A4, DRV5056A8		0.12		%/°C	
		DRV5056Z1, DRV5056Z2, DRV5056Z3, DRV5056Z4		0		%/°C	
S <sub>LE</sub>	Sensitivity linearity error <sup>(3)</sup>	$V_{OUT}$ is within $V_L$		±1%			
S <sub>RE</sub>	Sensitivity ratiometry error <sup>(5)</sup>	$T_A = 25^\circ\text{C}$ , with respect to $V_{CC} = 3.3\text{ V}$ or $5\text{ V}$	-2.5%		2.5%		
S <sub>ΔL</sub>	Sensitivity lifetime drift	High-temperature operating stress for 1000 hours		< 0.5%			

- (1) B is the applied magnetic flux density.
- (2) B<sub>L</sub> describes the minimum linear sensing range at 25°C taking into account the maximum V<sub>Q</sub> and Sensitivity tolerances.
- (3) See the Section 6.3.3 section.
- (4) S<sub>TC</sub> describes the rate the device increases Sensitivity with temperature. For more information, see the Section 6.3.6 section.
- (5) See the Section 6.3.4 section.

## 5.7 Typical Characteristics

at  $T_A = 25^\circ\text{C}$  (unless otherwise noted)

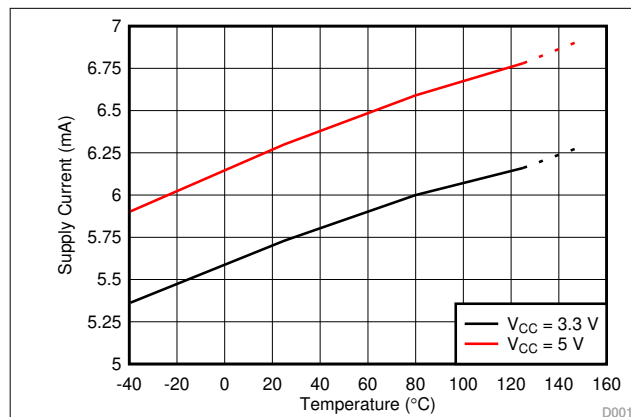

Figure 5-1. Supply Current vs Temperature

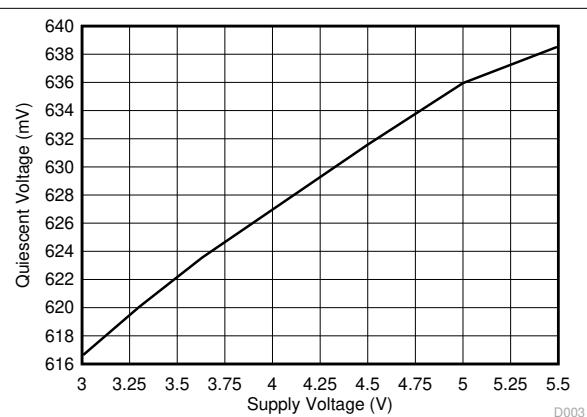

Figure 5-2. Quiescent Voltage vs Supply Voltage

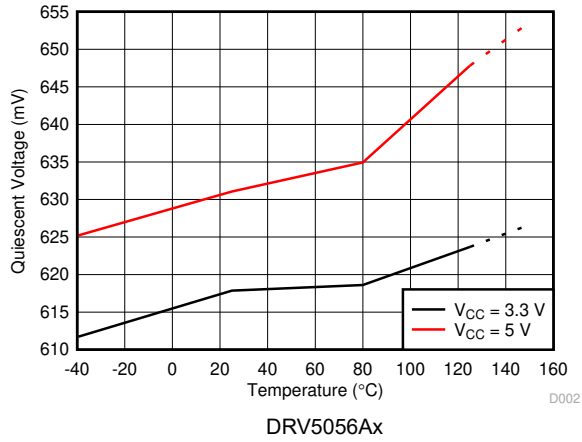

Figure 5-3. Quiescent Voltage vs Temperature

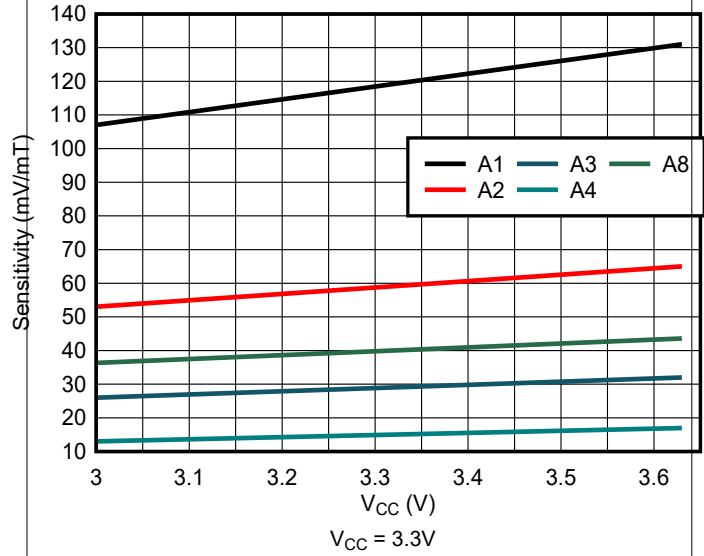

Figure 5-4. Sensitivity vs Supply Voltage

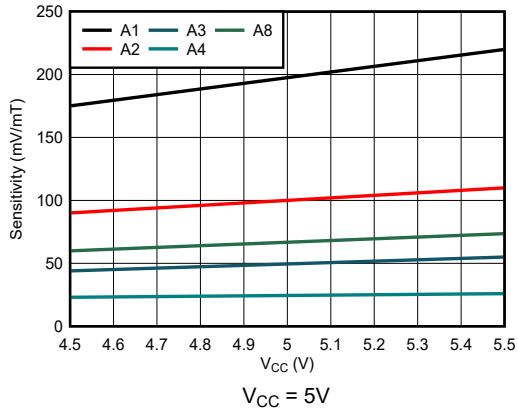

Figure 5-5. Sensitivity vs Supply Voltage

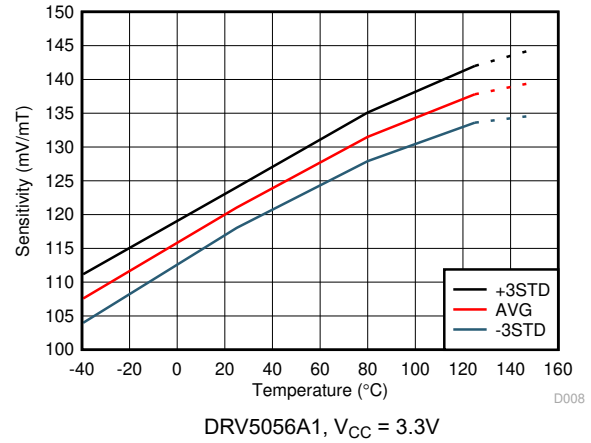

Figure 5-6. Sensitivity vs Temperature

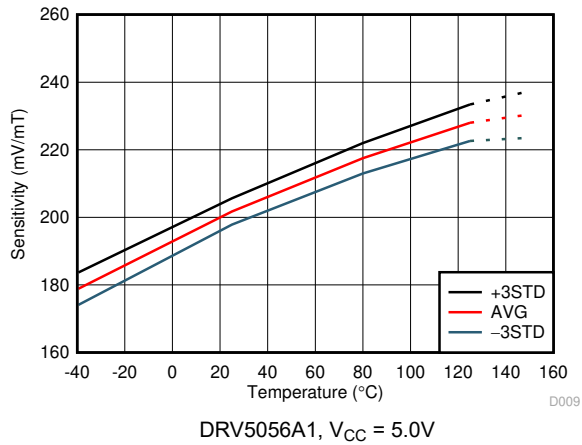

Figure 5-7. Sensitivity vs Temperature

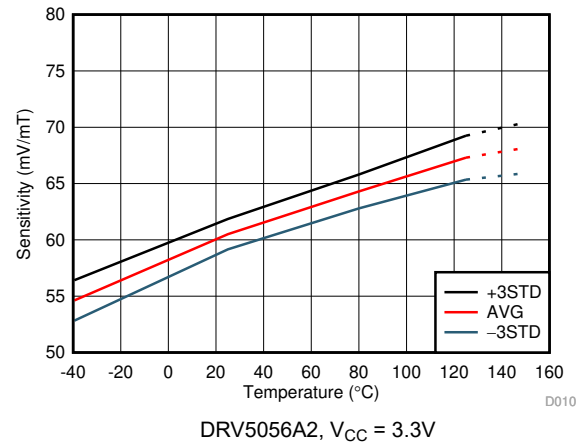
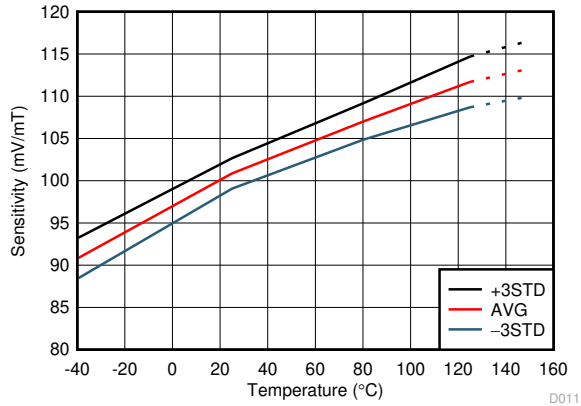
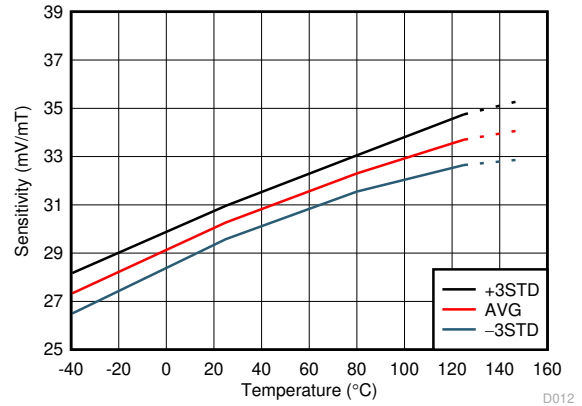

Figure 5-8. Sensitivity vs Temperature



DRV5056A2,  $V_{CC} = 5.0V$

**Figure 5-9. Sensitivity vs Temperature**



DRV5056A3,  $V_{CC} = 3.3V$

**Figure 5-10. Sensitivity vs Temperature**

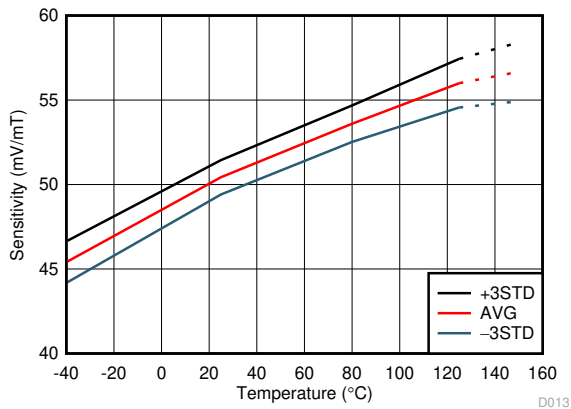

DRV5056A3,  $V_{CC} = 5.0V$

**Figure 5-11. Sensitivity vs Temperature**

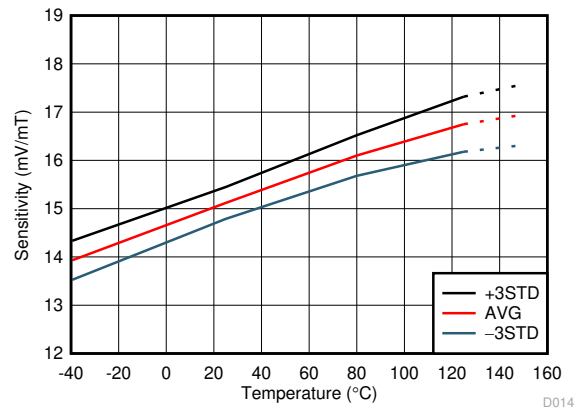

DRV5056A4,  $V_{CC} = 3.3V$

**Figure 5-12. Sensitivity vs Temperature**

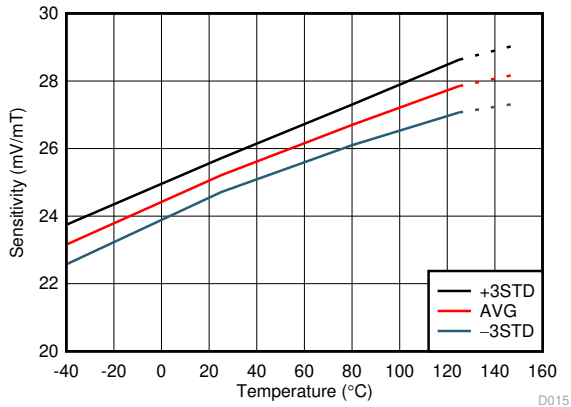

DRV5056A4,  $V_{CC} = 5.0V$

**Figure 5-13. Sensitivity vs Temperature**

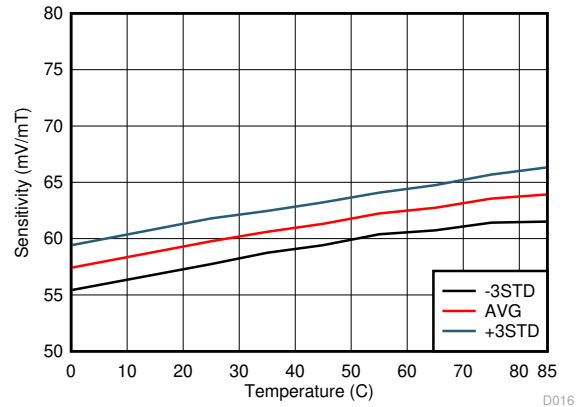

DRV5056A6,  $V_{CC} = 3.3V$

**Sensitivity vs Temperature**



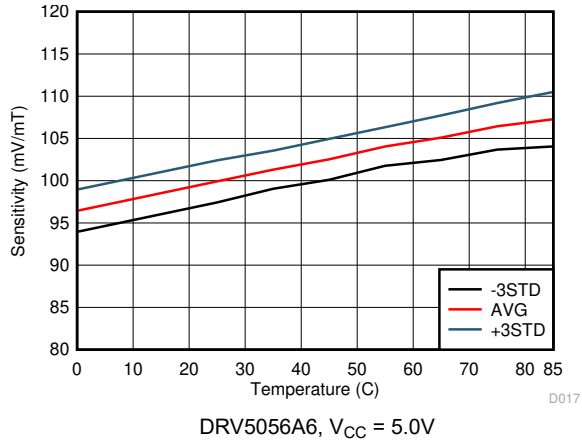

Sensitivity vs Temperature

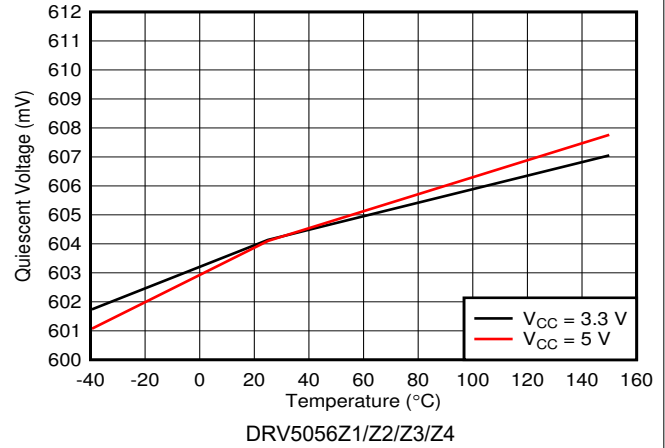

Figure 5-14. Quiescent Voltage vs Temperature

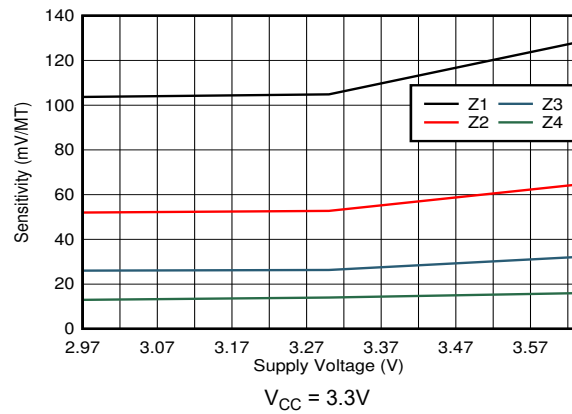

Figure 5-15. Sensitivity vs Supply Voltage

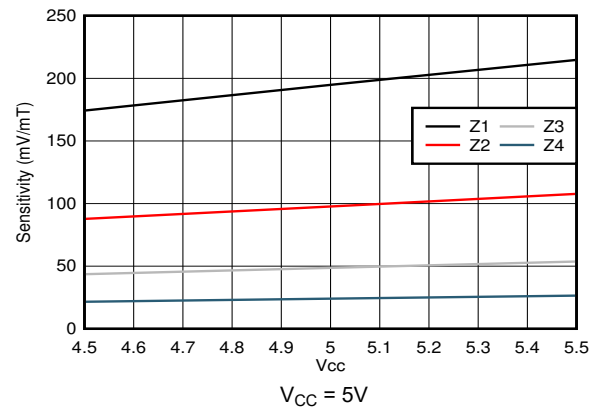

Figure 5-16. Sensitivity vs Supply Voltage

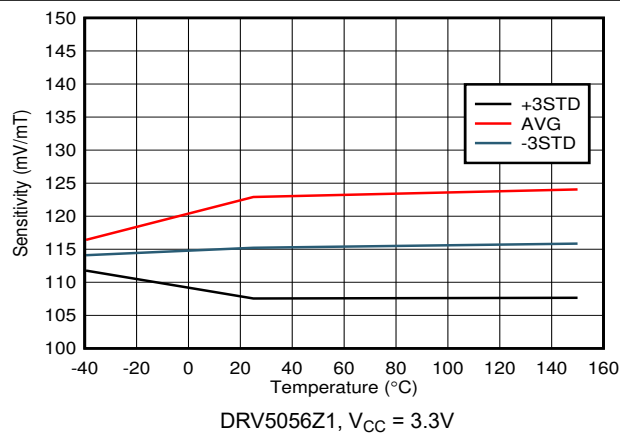

Figure 5-17. Sensitivity vs Temperature

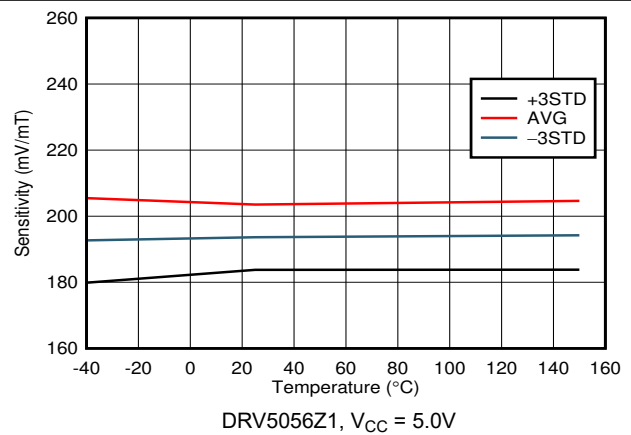
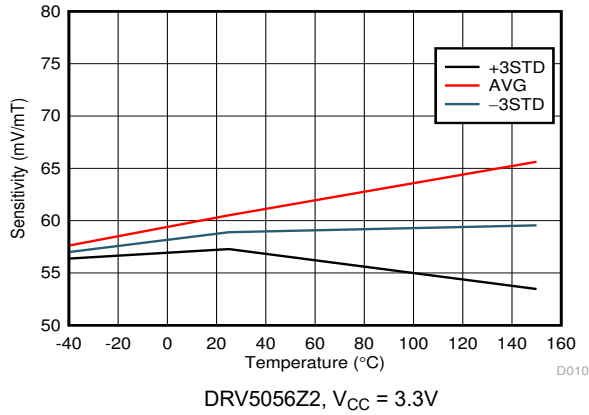
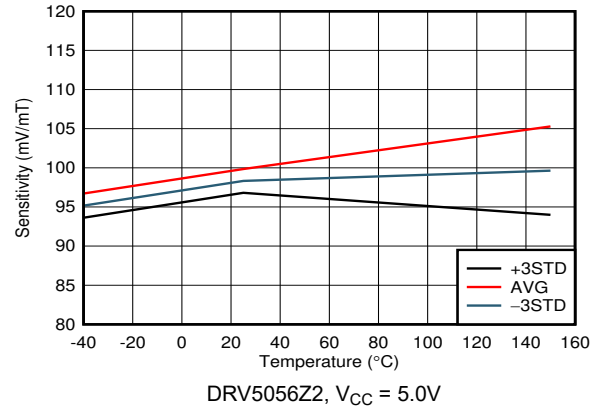

Figure 5-18. Sensitivity vs Temperature



**Figure 5-19. Sensitivity vs Temperature**



**Figure 5-20. Sensitivity vs Temperature**

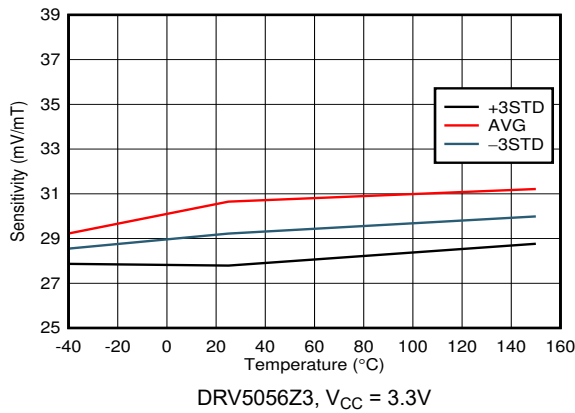

**Figure 5-21. Sensitivity vs Temperature**

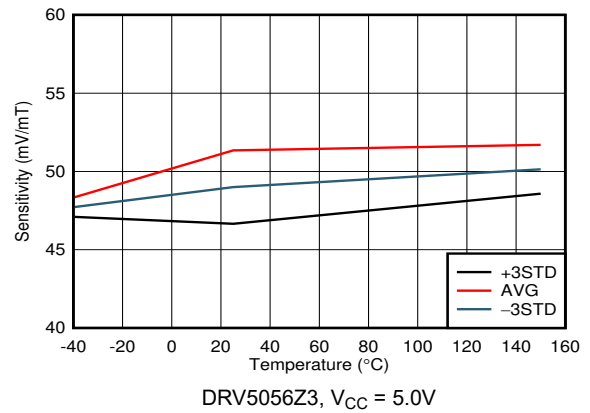

**Figure 5-22. Sensitivity vs Temperature**

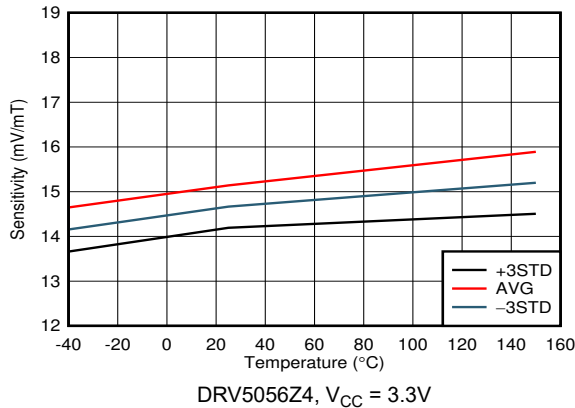

**Figure 5-23. Sensitivity vs Temperature**

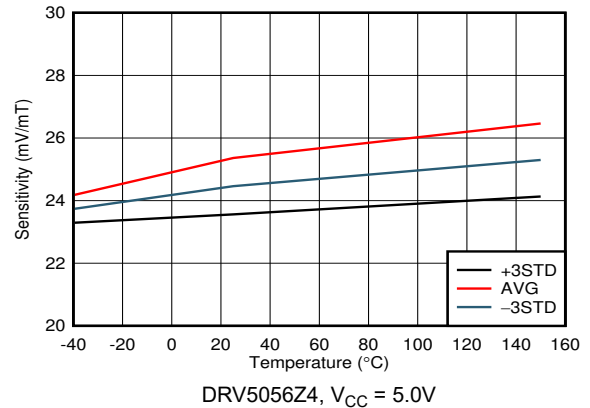

**Figure 5-24. Sensitivity vs Temperature**

## 6 Detailed Description

### 6.1 Overview

The DRV5056 is a 3-pin linear Hall-effect sensor with fully integrated signal conditioning, temperature compensation circuits, mechanical stress cancellation, and amplifiers. The device operates from 3.3V and 5V ( $\pm 10\%$ ) power supplies, measures magnetic flux density, and outputs a proportional analog voltage that is referenced to  $V_{CC}$ .

### 6.2 Functional Block Diagram

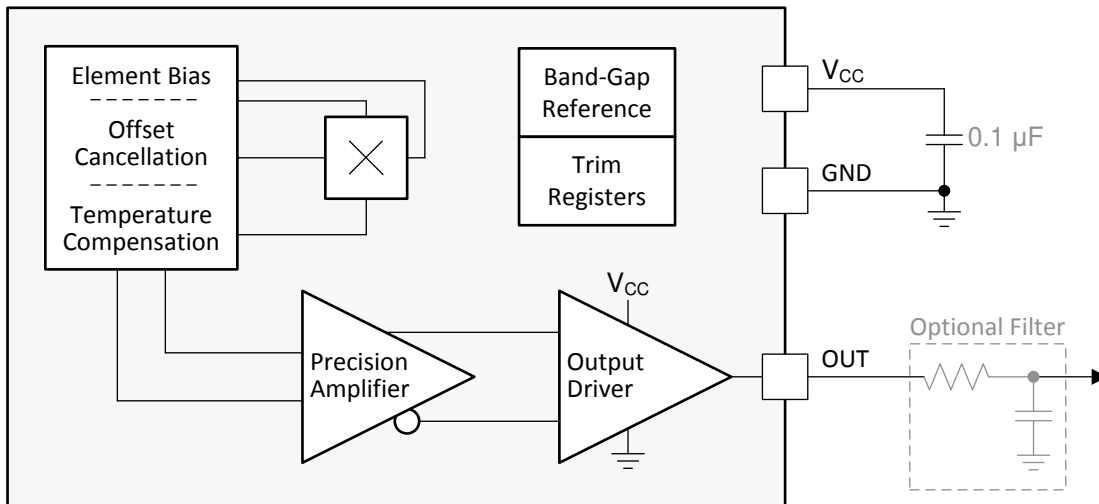

### 6.3 Feature Description

#### 6.3.1 Magnetic Flux Direction

As shown in [Figure 6-1](#), the DRV5056 is sensitive to the magnetic field component that is perpendicular to the die inside the package.

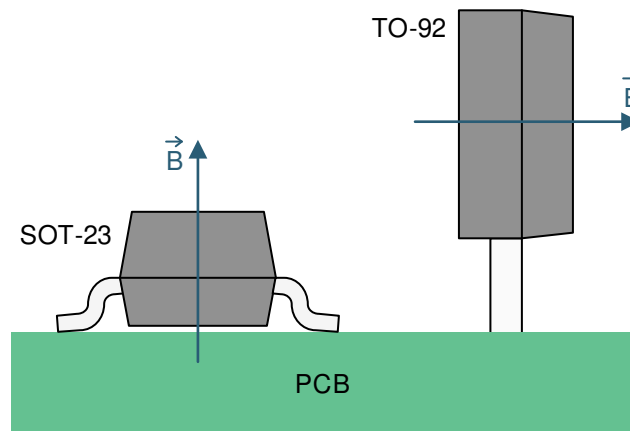

**Figure 6-1. Direction of Sensitivity**

Magnetic flux that travels from the bottom to the top of the package is considered positive. This condition exists when a south magnetic pole is near the top (marked-side) of the package. Magnetic flux that travels from the top to the bottom of the package results in negative millitesla values.

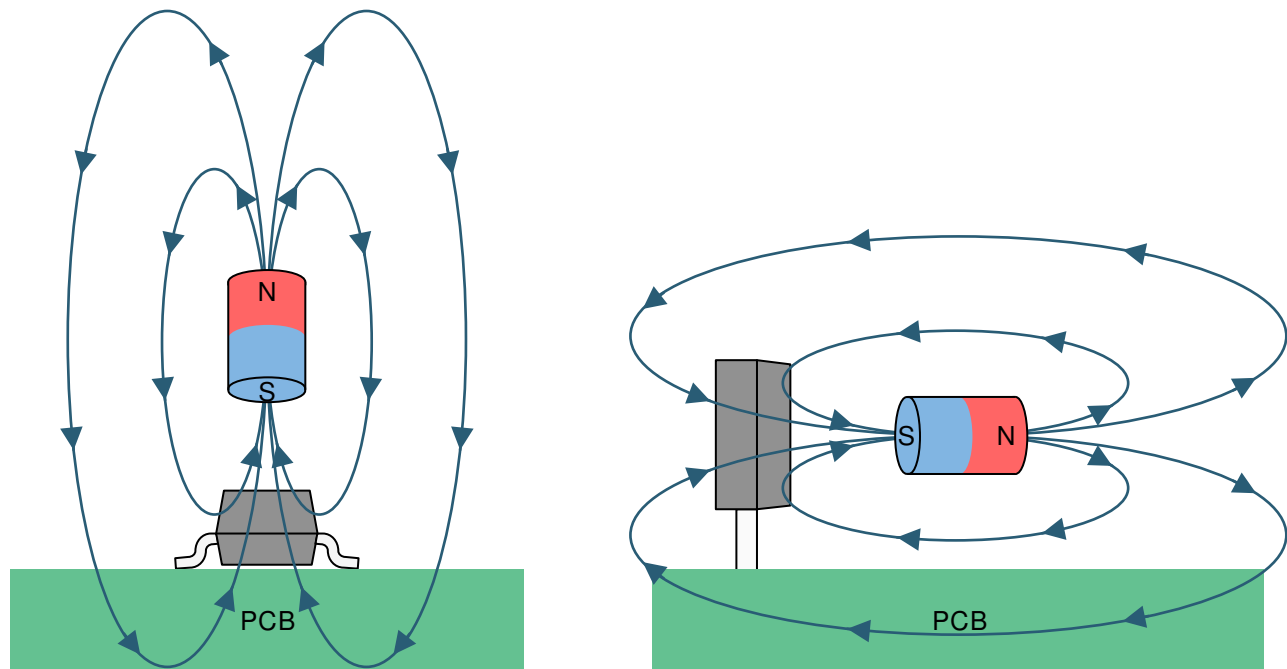

**Figure 6-2. The Flux Direction for Positive B**

### 6.3.2 Magnetic Response

The DRV5056 outputs an analog voltage according to [Equation 1](#) when in the presence of a magnetic field:

$$V_{OUT} = V_Q + B \times (\text{Sensitivity}_{(25^\circ\text{C})} \times (1 + S_{TC} \times (T_A - 25^\circ\text{C}))) \quad (1)$$

where

- $V_Q$  is typically 600mV
- $B$  is the applied magnetic flux density
- $\text{Sensitivity}_{(25^\circ\text{C})}$  depends on the device option and  $V_{CC}$
- $S_{TC}$  is typically 0.12%/°C for device options DRV5056Ax and is 0%/°C for DRV5056Zx options
- $T_A$  is the ambient temperature
- $V_{OUT}$  is within the  $V_L$  range

As an example, consider the DRV5056A3 with  $V_{CC} = 3.3\text{V}$ , a temperature of  $50^\circ\text{C}$ , and 67mT applied. Excluding tolerances,  $V_{OUT} = 600\text{mV} + 67 \text{ mT} \times (30\text{mV/mT} \times [1 + 0.0012/^\circ\text{C} \times (50^\circ\text{C} - 25^\circ\text{C})]) = 2.67\text{V}$ .

The DRV5056 only responds to the flux density of a magnetic south pole.

### 6.3.3 Sensitivity Linearity

The device produces a linear response when the output voltage is within the specified  $V_L$  range. Outside this range, sensitivity is reduced and nonlinear. Figure 6-3 graphs the magnetic response.

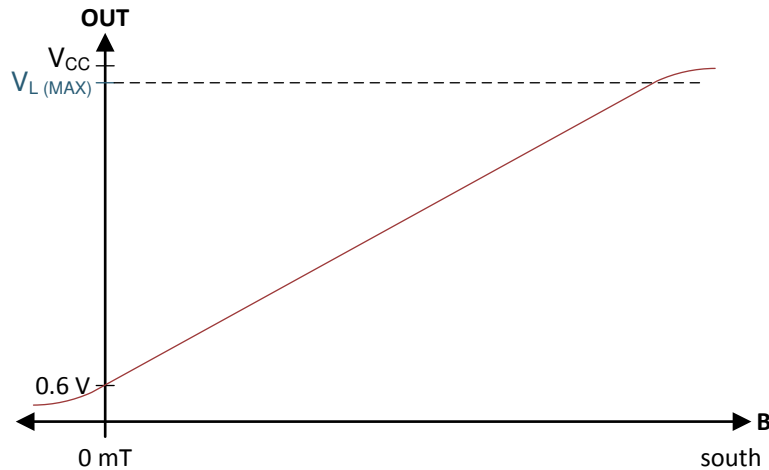

**Figure 6-3. Magnetic Response**

Equation 2 calculates parameter  $B_L$ , the minimum linear sensing range at 25°C taking into account the maximum quiescent voltage and sensitivity tolerances.

$$B_{L(MIN)} = \frac{V_{L(MAX)} - V_{Q(MAX)}}{S_{(MAX)}} \quad (2)$$

The parameter  $S_{LE}$  defines linearity error as the difference in sensitivity between any two positive  $B$  values when the output is within the  $V_L$  range.

### 6.3.4 Ratiometric Architecture

The DRV5056 has a ratiometric analog architecture that scales the sensitivity linearly with the power-supply voltage. For example, the sensitivity is 5% higher when  $V_{CC} = 5.25V$  compared to  $V_{CC} = 5V$ . This behavior enables external ADCs to digitize a more consistent value regardless of the power-supply voltage tolerance, when the ADC uses  $V_{CC}$  as the reference.

Equation 3 calculates sensitivity ratiometry error:

$$S_{RE} = 1 - \frac{S_{(V_{CC})} / S_{(5V)}}{V_{CC} / 5V} \text{ for } V_{CC} = 4.5 \text{ V to } 5.5 \text{ V}, \quad S_{RE} = 1 - \frac{S_{(V_{CC})} / S_{(3.3V)}}{V_{CC} / 3.3V} \text{ for } V_{CC} = 3 \text{ V to } 3.6 \text{ V} \quad (3)$$

where

- $S_{(V_{CC})}$  is the sensitivity at the current  $V_{CC}$  voltage
- $S_{(5V)}$  or  $S_{(3.3V)}$  is the sensitivity when  $V_{CC} = 5V$  or  $3.3V$
- $V_{CC}$  is the current  $V_{CC}$  voltage

### 6.3.5 Operating $V_{CC}$ Ranges

The DRV5056 has two recommended operating  $V_{CC}$  ranges: 3V to 3.6V and 4.5V to 5.5V. When  $V_{CC}$  is in the middle region between 3.6V to 4.5V, the device continues to function, but sensitivity is less known because there is a crossover threshold near 4V that adjusts device characteristics.

### 6.3.6 Sensitivity Temperature Compensation For Magnets

Magnets generally produce weaker fields as temperature increases. The DRV5056 can either compensate by increasing sensitivity with temperature or keep the sensitivity constant, as defined by the parameters  $S_{TC}$  and  $S_{TCz}$  respectively. For DRV5056Ax device options, the sensitivity at  $T_A = 125^\circ\text{C}$  is typically 12% higher than at  $T_A = 25^\circ\text{C}$ . For DRV5056Zx device options, the sensitivity at  $T_A = 125^\circ\text{C}$  is typically same as the value at  $T_A = 25^\circ\text{C}$ .

### 6.3.7 Power-On Time

After the  $V_{CC}$  voltage is applied, the DRV5056 requires a short initialization time before the output is set. The parameter  $t_{ON}$  describes the time from when  $V_{CC}$  crosses 3V until OUT is within 5% of  $V_Q$ , with 0mT applied and no load attached to OUT. Figure 6-4 shows this timing diagram.

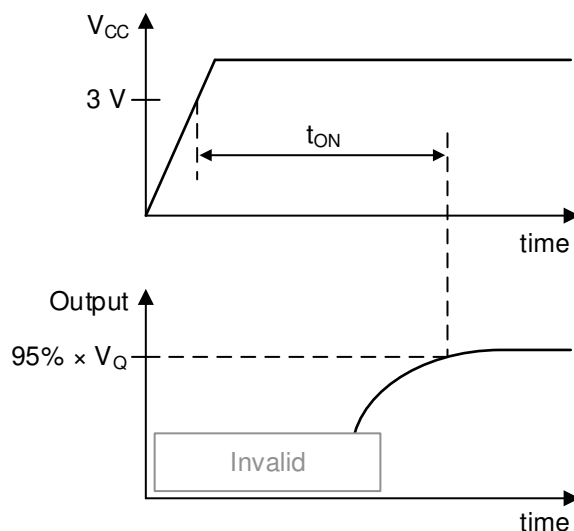
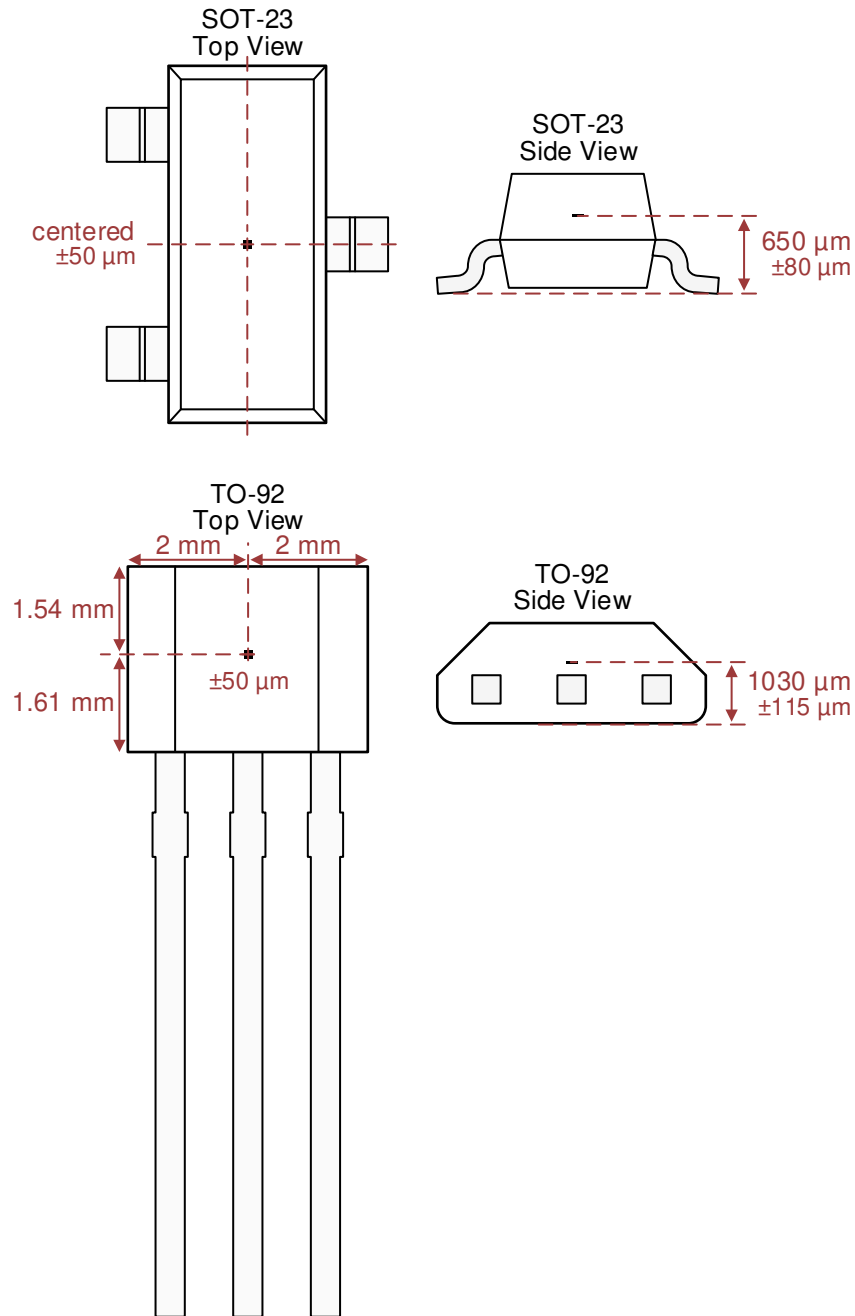

Figure 6-4.  $t_{ON}$  Definition

### 6.3.8 Hall Element Location

Figure 6-5 shows the location of the sensing element inside each package option.



**Figure 6-5. Hall Element Location**

### 6.4 Device Functional Modes

The DRV5056 has one mode of operation that applies when the *Recommended Operating Conditions* are met.

## 7 Application and Implementation

### Note

Information in the following applications sections is not part of the TI component specification, and TI does not warrant its accuracy or completeness. TI's customers are responsible for determining suitability of components for their purposes, as well as validating and testing their design implementation to confirm system functionality.

### 7.1 Application Information

#### 7.1.1 Selecting the Sensitivity Option

Select the highest DRV5056 sensitivity option that can measure the required range of magnetic flux density, so that the output voltage swing is maximized.

Larger magnets and greater sensing distances can generally enable better positional accuracy than very small magnets at close distances, because magnetic flux density increases exponentially with the proximity to a magnet.

#### 7.1.2 Temperature Compensation for Magnets

The DRV5056 temperature compensation is designed to directly compensate the average drift of neodymium (NdFeB) magnets and partially compensate ferrite magnets. The residual flux density ( $B_r$ ) of a magnet typically reduces by 0.12%/°C for NdFeB, and 0.20%/°C for ferrite. When the operating temperature range of a system is reduced, temperature drift errors are also reduced.

#### 7.1.3 Adding a Low-Pass Filter

As illustrated in the [Functional Block Diagram](#), an RC low-pass filter can be added to the device output for the purpose of minimizing voltage noise when the full 20kHz bandwidth is not needed. This filter can improve the signal-to-noise ratio (SNR) and overall accuracy. Do not connect a capacitor directly to the device output without a resistor in between because doing so can make the output unstable.

#### 7.1.4 Designing for Wire Break Detection

Some systems must detect if interconnect wires become open or shorted. The DRV5056 can support this function.

First, select a sensitivity option that causes the output voltage to stay within the  $V_L$  range during normal operation. Second, add a pullup resistor between OUT and  $V_{CC}$ . TI recommends a value between 20k $\Omega$  to 100 k $\Omega$ , and the current through OUT must not exceed the  $I_O$  specification, including current going into an external ADC. Then, if the output voltage is ever measured to be within 150mV of  $V_{CC}$  or GND, a fault condition exists. [Figure 7-1](#) shows the circuit, and [Table 7-1](#) describes fault scenarios.

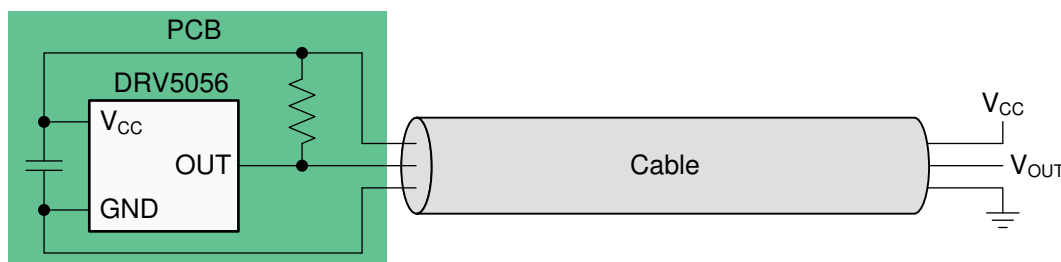

**Figure 7-1. Wire Fault Detection Circuit**



**Table 7-1. Fault Scenarios and the Resulting  $V_{OUT}$**

FAULT SCENARIO	$V_{OUT}$
$V_{CC}$ disconnects	Close to GND
GND disconnects	Close to $V_{CC}$
$V_{CC}$ shorts to OUT	Close to $V_{CC}$
GND shorts to OUT	Close to GND

## 7.2 Typical Application

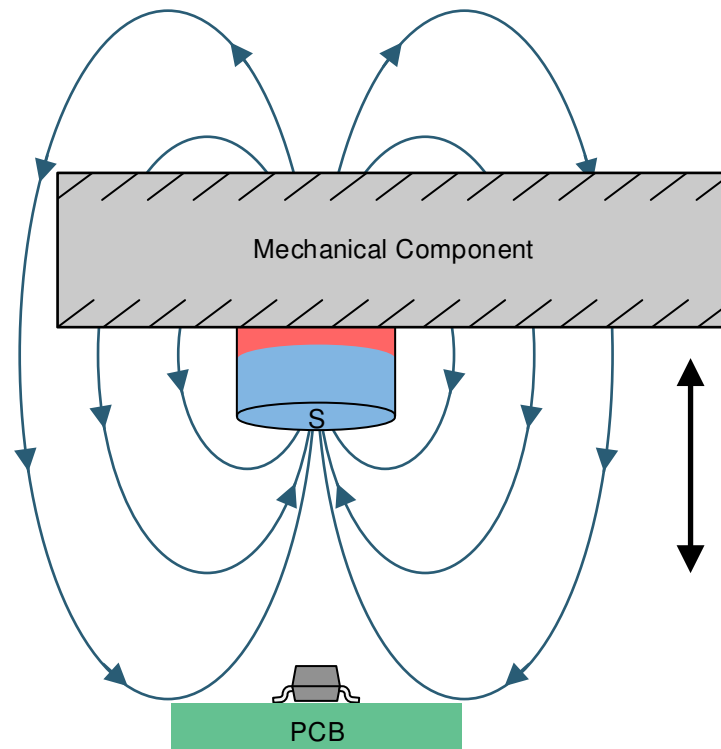

**Figure 7-2. Unipolar Sensing Application**

### 7.2.1 Design Requirements

Use the parameters listed in [Table 7-2](#) for this design example.

**Table 7-2. Design Parameters**

DESIGN PARAMETER	EXAMPLE VALUE
$V_{CC}$	3.3V
Magnet	10mm diameter × 6mm long cylinder, ferrite
Distance from magnet to sensor	From 20mm to 3mm
Maximum B at the sensor at 25°C	72mT at 3mm
Device option	DRV5056A3

### 7.2.2 Detailed Design Procedure

This design example consists of a mechanical component that moves back and forth, an embedded magnet with the south pole facing the printed-circuit board, and a DRV5056 . The DRV5056 outputs an analog voltage that describes the precise position of the component. The component must not contain ferromagnetic materials such as iron, nickel, and cobalt because these materials change the magnetic flux density at the sensor.

When designing a linear magnetic sensing system, always consider these three variables: the magnet, sensing distance, and range of the sensor. Select the DRV5056 with the highest sensitivity that has a  $B_L$  (linear magnetic sensing range) that is larger than the maximum magnetic flux density in the application.

Magnets are made from various ferromagnetic materials that have tradeoffs in cost, drift with temperature, absolute maximum temperature ratings, remanence or residual induction ( $B_r$ ), and coercivity ( $H_c$ ). The  $B_r$  and the dimensions of a magnet determine the magnetic flux density ( $B$ ) produced in 3-dimensional space. For simple magnet shapes, such as rectangular blocks and cylinders, there are simple equations that solve  $B$  at a given distance centered with the magnet. Figure 7-3 shows diagrams for Equation 4 and Equation 5.

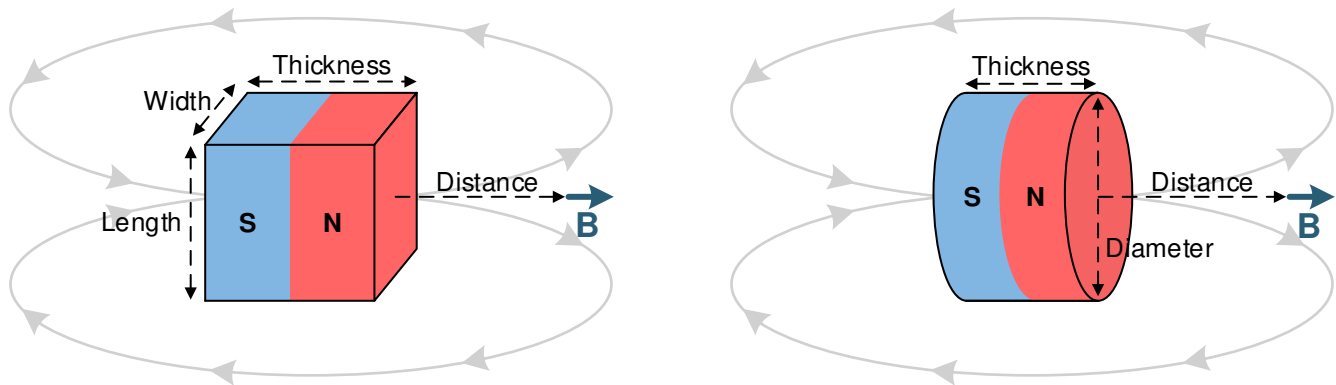

**Figure 7-3. Rectangular Block and Cylinder Magnets**

Use Equation 4 for the rectangular block shown in Figure 7-3:

$$\vec{B} = \frac{B_r}{\pi} \left( \arctan\left(\frac{WL}{2D\sqrt{4D^2 + W^2 + L^2}}\right) - \arctan\left(\frac{WL}{2(D+T)\sqrt{4(D+T)^2 + W^2 + L^2}}\right) \right) \quad (4)$$

Use Equation 5 for the cylinder shown in Figure 7-3:

$$\vec{B} = \frac{B_r}{2} \left( \frac{D+T}{\sqrt{(0.5C)^2 + (D+T)^2}} - \frac{D}{\sqrt{(0.5C)^2 + D^2}} \right) \quad (5)$$

where

- W is width
- L is length
- T is thickness (the direction of magnetization)
- D is distance
- C is diameter

### 7.2.3 Application Curve

Figure 7-4 shows the magnetic flux density versus distance for a 10mm × 6mm cylinder ferrite magnet.

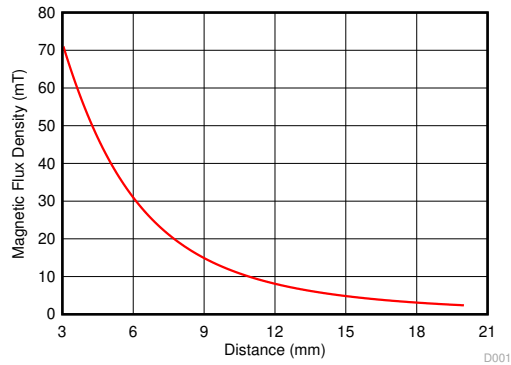

**Figure 7-4. Magnetic Profile of a 10mm × 6mm Cylindrical Ferrite Magnet**

### 7.3 Best System Practices

Because the Hall element is sensitive to magnetic fields that are perpendicular to the top of the package, a correct magnet approach must be used for the sensor to detect the field. Figure 7-5 illustrates correct and incorrect approaches.

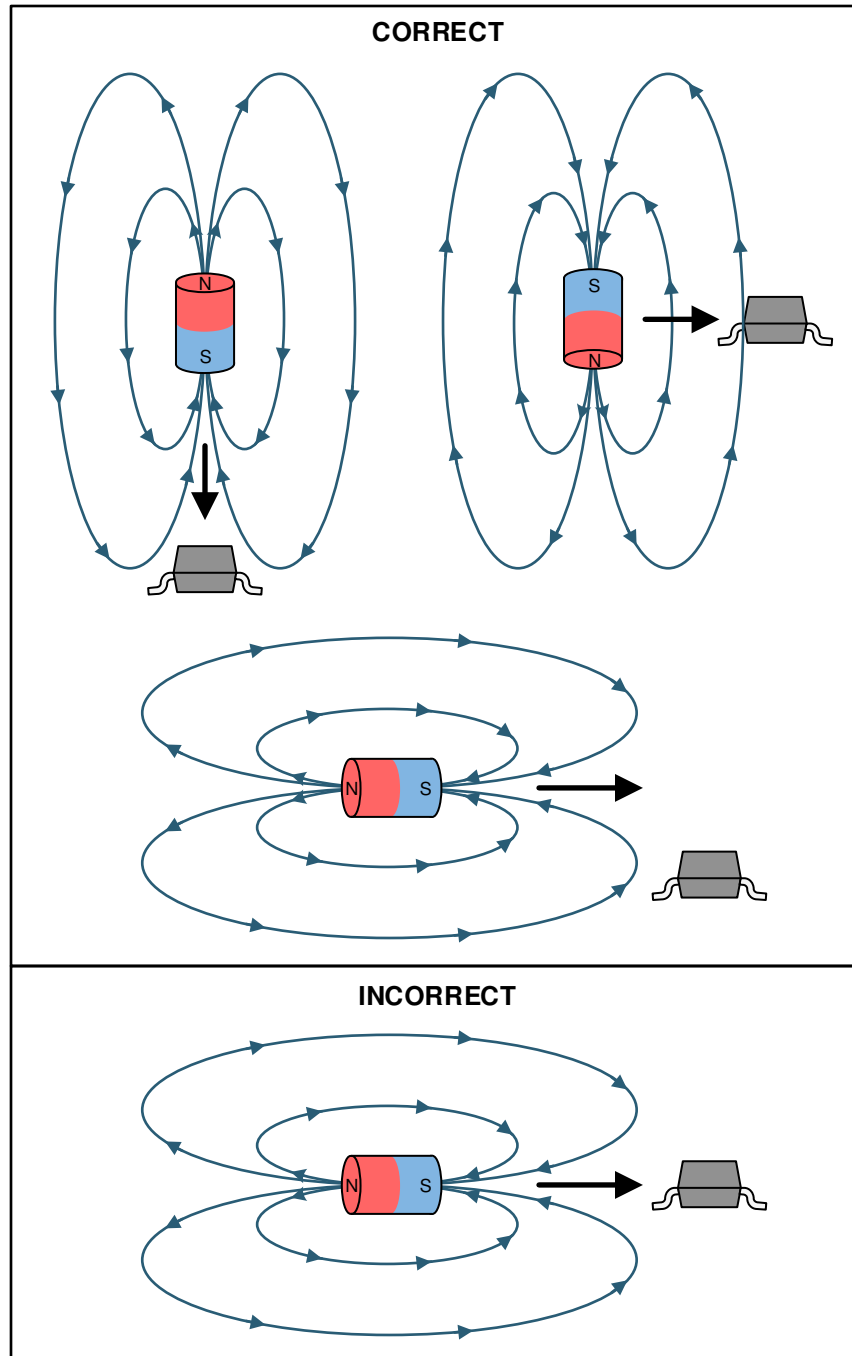

**Figure 7-5. Correct and Incorrect Magnet Approaches**

## 7.4 Power Supply Recommendations

A decoupling capacitor close to the device must be used to provide local energy with minimal inductance. TI recommends using a ceramic capacitor with a value of at least  $0.01\mu\text{F}$ .

## 7.5 Layout

### 7.5.1 Layout Guidelines

Magnetic fields pass through most nonferromagnetic materials with no significant disturbance. Embedding Hall-effect sensors within plastic or aluminum enclosures and sensing magnets on the outside is common practice. Magnetic fields also easily pass through most printed-circuit boards, which makes placing the magnet on the opposite side possible.

### 7.5.2 Layout Examples

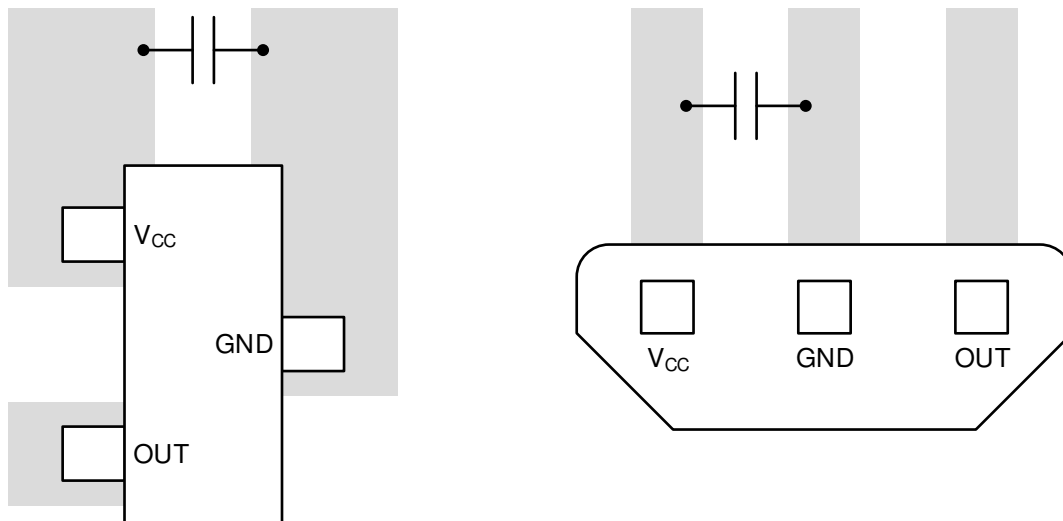

**Figure 7-6. Layout Examples**

## 8 Device and Documentation Support

### 8.1 Documentation Support

#### 8.1.1 Related Documentation

For related documentation see the following:

- Texas Instruments, [Incremental rotary encoder design considerations application note](#)
- Texas Instruments, [Using linear hall effect sensors to measure angle application note](#)
- Texas Instruments, [Angle measurements with linear hall effect sensors](#)

### 8.2 Receiving Notification of Documentation Updates

To receive notification of documentation updates, navigate to the device product folder on [ti.com](http://ti.com). Click on *Notifications* to register and receive a weekly digest of any product information that has changed. For change details, review the revision history included in any revised document.

### 8.3 Support Resources

[TI E2E™ support forums](#) are an engineer's go-to source for fast, verified answers and design help — straight from the experts. Search existing answers or ask your own question to get the quick design help you need.

Linked content is provided "AS IS" by the respective contributors. They do not constitute TI specifications and do not necessarily reflect TI's views; see TI's [Terms of Use](#).

### 8.4 Trademarks

TI E2E™ is a trademark of Texas Instruments.

All trademarks are the property of their respective owners.

### 8.5 Electrostatic Discharge Caution



This integrated circuit can be damaged by ESD. Texas Instruments recommends that all integrated circuits be handled with appropriate precautions. Failure to observe proper handling and installation procedures can cause damage.

ESD damage can range from subtle performance degradation to complete device failure. Precision integrated circuits may be more susceptible to damage because very small parametric changes could cause the device not to meet its published specifications.

### 8.6 Glossary

[TI Glossary](#) This glossary lists and explains terms, acronyms, and definitions.

## 9 Revision History

NOTE: Page numbers for previous revisions may differ from page numbers in the current version.

Changes from Revision B (March 2020) to Revision C (December 2025)	Page
• Updated the numbering format for tables, figures, and cross-references throughout the document.....	1
• Updated Features list with A8 variant information.....	1
• Changed <i>Device Information</i> table to <i>Package Information</i> .....	1
• Added DRV5056A8 Output-referred noise to <i>Electrical Characteristics</i> .....	5
• Added DRV5056A8 Quiescent voltage to <i>Magnetic Characteristics</i> .....	5
• Added DRV5056A8 Sensitivity to <i>Magnetic Characteristics</i> .....	5
• Added DRV5056A8 Linear magnetic sensing range to <i>Magnetic Characteristics</i> .....	5
• Updated the device naming in <i>Magnetic Response</i> .....	12
• Updated the device naming in <i>Sensitivity Temperature Compensation For Magnets</i> .....	14
• Changed <i>What to Do and What Not to Do</i> section to <i>Best System Practices</i> .....	19

Changes from Revision * (February 2019) to Revision B (March 2020)	Page
• Added Zero TC sensitivity options .....	1

---

• Added Zero TC information to Recommended Operating Conditions section.....	4
• <i>Added Zero TC information to Electrical Characteristics</i> .....	5
• Added Zero TC information to Magnetic Characteristics.....	5
• Added graphs for DRV5056Z1/Z2/Z3/Z4 options in the <i>Typical Characteristics</i> section.....	6
• Updated $S_{TC}$ definition in <a href="#">Equation 1</a> .....	12
• Updated the <i>Sensitivity Temperature Compensation For Magnets</i> section for Zero TC options.....	14

---

<b>Changes from Revision * (April 2018) to Revision A (February 2019)</b>	<b>Page</b>
• Added new A6 magnetic sensitivity option to the data sheet.....	1

---

## 10 Mechanical, Packaging, and Orderable Information

The following pages include mechanical, packaging, and orderable information. This information is the most current data available for the designated devices. This data is subject to change without notice and revision of this document. For browser-based versions of this data sheet, refer to the left-hand navigation.

**PACKAGING INFORMATION**

Orderable part number	Status (1)	Material type (2)	Package   Pins	Package qty   Carrier	RoHS (3)	Lead finish/ Ball material (4)	MSL rating/ Peak reflow (5)	Op temp (°C)	Part marking (6)
<a href="#">DRV5056A1QDBZR</a>	Active	Production	SOT-23 (DBZ)   3	3000   LARGE T&R	Yes	SN	Level-2-260C-1 YEAR	-40 to 125	56A1
DRV5056A1QDBZR.A	Active	Production	SOT-23 (DBZ)   3	3000   LARGE T&R	Yes	SN	Level-2-260C-1 YEAR	-40 to 125	56A1
DRV5056A1QDBZR.B	Active	Production	SOT-23 (DBZ)   3	3000   LARGE T&R	Yes	SN	Level-2-260C-1 YEAR	-40 to 125	56A1
<a href="#">DRV5056A1QDBZT</a>	Obsolete	Production	SOT-23 (DBZ)   3	-	-	Call TI	Call TI	-40 to 125	56A1
<a href="#">DRV5056A1QLPG</a>	Active	Production	TO-92 (LPG)   3	1000   BULK	Yes	SN	N/A for Pkg Type	-40 to 125	56A1
DRV5056A1QLPG.B	Active	Production	TO-92 (LPG)   3	1000   BULK	Yes	SN	N/A for Pkg Type	-40 to 125	56A1
<a href="#">DRV5056A1QLPGM</a>	Active	Production	TO-92 (LPG)   3	3000   AMMO	Yes	SN	N/A for Pkg Type	-40 to 125	56A1
DRV5056A1QLPGM.A	Active	Production	TO-92 (LPG)   3	3000   AMMO	Yes	SN	N/A for Pkg Type	-40 to 125	56A1
DRV5056A1QLPGM.B	Active	Production	TO-92 (LPG)   3	3000   AMMO	Yes	SN	N/A for Pkg Type	-40 to 125	56A1
<a href="#">DRV5056A2QDBZR</a>	Active	Production	SOT-23 (DBZ)   3	3000   LARGE T&R	Yes	SN	Level-2-260C-1 YEAR	-40 to 125	56A2
DRV5056A2QDBZR.A	Active	Production	SOT-23 (DBZ)   3	3000   LARGE T&R	Yes	SN	Level-2-260C-1 YEAR	-40 to 125	56A2
DRV5056A2QDBZR.B	Active	Production	SOT-23 (DBZ)   3	3000   LARGE T&R	Yes	SN	Level-2-260C-1 YEAR	-40 to 125	56A2
<a href="#">DRV5056A2QDBZT</a>	Obsolete	Production	SOT-23 (DBZ)   3	-	-	Call TI	Call TI	-40 to 125	56A2
<a href="#">DRV5056A2QLPG</a>	Active	Production	TO-92 (LPG)   3	1000   BULK	Yes	SN	N/A for Pkg Type	-40 to 125	56A2
DRV5056A2QLPG.B	Active	Production	TO-92 (LPG)   3	1000   BULK	Yes	SN	N/A for Pkg Type	-40 to 125	56A2
<a href="#">DRV5056A2QLPGM</a>	Active	Production	TO-92 (LPG)   3	3000   AMMO	Yes	SN	N/A for Pkg Type	-40 to 125	56A2
DRV5056A2QLPGM.A	Active	Production	TO-92 (LPG)   3	3000   AMMO	Yes	SN	N/A for Pkg Type	-40 to 125	56A2
DRV5056A2QLPGM.B	Active	Production	TO-92 (LPG)   3	3000   AMMO	Yes	SN	N/A for Pkg Type	-40 to 125	56A2
<a href="#">DRV5056A3QDBZR</a>	Active	Production	SOT-23 (DBZ)   3	3000   LARGE T&R	Yes	SN	Level-2-260C-1 YEAR	-40 to 125	56A3
DRV5056A3QDBZR.A	Active	Production	SOT-23 (DBZ)   3	3000   LARGE T&R	Yes	SN	Level-2-260C-1 YEAR	-40 to 125	56A3
DRV5056A3QDBZR.B	Active	Production	SOT-23 (DBZ)   3	3000   LARGE T&R	Yes	SN	Level-2-260C-1 YEAR	-40 to 125	56A3
<a href="#">DRV5056A3QDBZT</a>	Obsolete	Production	SOT-23 (DBZ)   3	-	-	Call TI	Call TI	-40 to 125	56A3
<a href="#">DRV5056A3QLPG</a>	Active	Production	TO-92 (LPG)   3	1000   BULK	Yes	SN	N/A for Pkg Type	-40 to 125	56A3
DRV5056A3QLPG.B	Active	Production	TO-92 (LPG)   3	1000   BULK	Yes	SN	N/A for Pkg Type	-40 to 125	56A3
<a href="#">DRV5056A3QLPGM</a>	Active	Production	TO-92 (LPG)   3	3000   AMMO	Yes	SN	N/A for Pkg Type	-40 to 125	56A3
DRV5056A3QLPGM.A	Active	Production	TO-92 (LPG)   3	3000   AMMO	Yes	SN	N/A for Pkg Type	-40 to 125	56A3
DRV5056A3QLPGM.B	Active	Production	TO-92 (LPG)   3	3000   AMMO	Yes	SN	N/A for Pkg Type	-40 to 125	56A3
<a href="#">DRV5056A4QDBZR</a>	Active	Production	SOT-23 (DBZ)   3	3000   LARGE T&R	Yes	SN	Level-2-260C-1 YEAR	-40 to 125	56A4
DRV5056A4QDBZR.A	Active	Production	SOT-23 (DBZ)   3	3000   LARGE T&R	Yes	SN	Level-2-260C-1 YEAR	-40 to 125	56A4



Orderable part number	Status (1)	Material type (2)	Package   Pins	Package qty   Carrier	RoHS (3)	Lead finish/ Ball material (4)	MSL rating/ Peak reflow (5)	Op temp (°C)	Part marking (6)
DRV5056A4QDBZR.B	Active	Production	SOT-23 (DBZ)   3	3000   LARGE T&R	Yes	SN	Level-2-260C-1 YEAR	-40 to 125	56A4
<a href="#">DRV5056A4QDBZT</a>	Obsolete	Production	SOT-23 (DBZ)   3	-	-	Call TI	Call TI	-40 to 125	56A4
<a href="#">DRV5056A4QLPG</a>	Active	Production	TO-92 (LPG)   3	1000   BULK	Yes	SN	N/A for Pkg Type	-40 to 125	56A4
DRV5056A4QLPG.B	Active	Production	TO-92 (LPG)   3	1000   BULK	Yes	SN	N/A for Pkg Type	-40 to 125	56A4
<a href="#">DRV5056A4QLPGM</a>	Active	Production	TO-92 (LPG)   3	3000   AMMO	Yes	SN	N/A for Pkg Type	-40 to 125	56A4
DRV5056A4QLPGM.A	Active	Production	TO-92 (LPG)   3	3000   AMMO	Yes	SN	N/A for Pkg Type	-40 to 125	56A4
DRV5056A4QLPGM.B	Active	Production	TO-92 (LPG)   3	3000   AMMO	Yes	SN	N/A for Pkg Type	-40 to 125	56A4
<a href="#">DRV5056A6QDBZR</a>	Active	Production	SOT-23 (DBZ)   3	3000   LARGE T&R	Yes	SN	Level-2-260C-1 YEAR	-40 to 125	56A6
DRV5056A6QDBZR.A	Active	Production	SOT-23 (DBZ)   3	3000   LARGE T&R	Yes	SN	Level-2-260C-1 YEAR	-40 to 125	56A6
DRV5056A6QDBZR.B	Active	Production	SOT-23 (DBZ)   3	3000   LARGE T&R	Yes	SN	Level-2-260C-1 YEAR	-40 to 125	56A6
<a href="#">DRV5056A6QDBZT</a>	Obsolete	Production	SOT-23 (DBZ)   3	-	-	Call TI	Call TI	-40 to 125	56A6
<a href="#">DRV5056A8QDBZR</a>	Active	Production	SOT-23 (DBZ)   3	3000   LARGE T&R	Yes	SN	Level-1-260C-UNLIM	-40 to 125	56A8
<a href="#">DRV5056Z1QDBZR</a>	Active	Production	SOT-23 (DBZ)   3	3000   LARGE T&R	Yes	SN	Level-2-260C-1 YEAR	-40 to 125	56Z1
DRV5056Z1QDBZR.A	Active	Production	SOT-23 (DBZ)   3	3000   LARGE T&R	Yes	SN	Level-2-260C-1 YEAR	-40 to 125	56Z1
DRV5056Z1QDBZR.B	Active	Production	SOT-23 (DBZ)   3	3000   LARGE T&R	Yes	SN	Level-2-260C-1 YEAR	-40 to 125	56Z1
<a href="#">DRV5056Z1QDBZT</a>	Obsolete	Production	SOT-23 (DBZ)   3	-	-	Call TI	Call TI	-40 to 125	56Z1
<a href="#">DRV5056Z2QDBZR</a>	Active	Production	SOT-23 (DBZ)   3	3000   LARGE T&R	Yes	SN	Level-2-260C-1 YEAR	-40 to 125	56Z2
DRV5056Z2QDBZR.A	Active	Production	SOT-23 (DBZ)   3	3000   LARGE T&R	Yes	SN	Level-2-260C-1 YEAR	-40 to 125	56Z2
DRV5056Z2QDBZR.B	Active	Production	SOT-23 (DBZ)   3	3000   LARGE T&R	Yes	SN	Level-2-260C-1 YEAR	-40 to 125	56Z2
<a href="#">DRV5056Z2QDBZT</a>	Obsolete	Production	SOT-23 (DBZ)   3	-	-	Call TI	Call TI	-40 to 125	56Z2
<a href="#">DRV5056Z3QDBZR</a>	Active	Production	SOT-23 (DBZ)   3	3000   LARGE T&R	Yes	SN	Level-2-260C-1 YEAR	-40 to 125	56Z3
DRV5056Z3QDBZR.A	Active	Production	SOT-23 (DBZ)   3	3000   LARGE T&R	Yes	SN	Level-2-260C-1 YEAR	-40 to 125	56Z3
DRV5056Z3QDBZR.B	Active	Production	SOT-23 (DBZ)   3	3000   LARGE T&R	Yes	SN	Level-2-260C-1 YEAR	-40 to 125	56Z3
<a href="#">DRV5056Z3QDBZT</a>	Obsolete	Production	SOT-23 (DBZ)   3	-	-	Call TI	Call TI	-40 to 125	56Z3
<a href="#">DRV5056Z4QDBZR</a>	Active	Production	SOT-23 (DBZ)   3	3000   LARGE T&R	Yes	SN	Level-2-260C-1 YEAR	-40 to 125	56Z4
DRV5056Z4QDBZR.A	Active	Production	SOT-23 (DBZ)   3	3000   LARGE T&R	Yes	SN	Level-2-260C-1 YEAR	-40 to 125	56Z4
DRV5056Z4QDBZR.B	Active	Production	SOT-23 (DBZ)   3	3000   LARGE T&R	Yes	SN	Level-2-260C-1 YEAR	-40 to 125	56Z4
<a href="#">DRV5056Z4QDBZT</a>	Obsolete	Production	SOT-23 (DBZ)   3	-	-	Call TI	Call TI	-40 to 125	56Z4

<sup>(1)</sup> **Status:** For more details on status, see our [product life cycle](#).

(2) **Material type:** When designated, preproduction parts are prototypes/experimental devices, and are not yet approved or released for full production. Testing and final process, including without limitation quality assurance, reliability performance testing, and/or process qualification, may not yet be complete, and this item is subject to further changes or possible discontinuation. If available for ordering, purchases will be subject to an additional waiver at checkout, and are intended for early internal evaluation purposes only. These items are sold without warranties of any kind.

(3) **RoHS values:** Yes, No, RoHS Exempt. See the [TI RoHS Statement](#) for additional information and value definition.

(4) **Lead finish/Ball material:** Parts may have multiple material finish options. Finish options are separated by a vertical ruled line. Lead finish/Ball material values may wrap to two lines if the finish value exceeds the maximum column width.

(5) **MSL rating/Peak reflow:** The moisture sensitivity level ratings and peak solder (reflow) temperatures. In the event that a part has multiple moisture sensitivity ratings, only the lowest level per JEDEC standards is shown. Refer to the shipping label for the actual reflow temperature that will be used to mount the part to the printed circuit board.

(6) **Part marking:** There may be an additional marking, which relates to the logo, the lot trace code information, or the environmental category of the part.

Multiple part markings will be inside parentheses. Only one part marking contained in parentheses and separated by a "~" will appear on a part. If a line is indented then it is a continuation of the previous line and the two combined represent the entire part marking for that device.

**Important Information and Disclaimer:** The information provided on this page represents TI's knowledge and belief as of the date that it is provided. TI bases its knowledge and belief on information provided by third parties, and makes no representation or warranty as to the accuracy of such information. Efforts are underway to better integrate information from third parties. TI has taken and continues to take reasonable steps to provide representative and accurate information but may not have conducted destructive testing or chemical analysis on incoming materials and chemicals. TI and TI suppliers consider certain information to be proprietary, and thus CAS numbers and other limited information may not be available for release.

In no event shall TI's liability arising out of such information exceed the total purchase price of the TI part(s) at issue in this document sold by TI to Customer on an annual basis.

**OTHER QUALIFIED VERSIONS OF DRV5056 :**

- Automotive : [DRV5056-Q1](#)

NOTE: Qualified Version Definitions:

- Automotive - Q100 devices qualified for high-reliability automotive applications targeting zero defects

**TAPE AND REEL INFORMATION**

**QUADRANT ASSIGNMENTS FOR PIN 1 ORIENTATION IN TAPE**

\*All dimensions are nominal

Device	Package Type	Package Drawing	Pins	SPQ	Reel Diameter (mm)	Reel Width W1 (mm)	A0 (mm)	B0 (mm)	K0 (mm)	P1 (mm)	W (mm)	Pin1 Quadrant
DRV5056A1QDBZR	SOT-23	DBZ	3	3000	180.0	8.4	3.2	2.85	1.3	4.0	8.0	Q3
DRV5056A2QDBZR	SOT-23	DBZ	3	3000	180.0	8.4	3.2	2.85	1.3	4.0	8.0	Q3
DRV5056A2QDBZR	SOT-23	DBZ	3	3000	180.0	8.4	3.2	2.85	1.3	4.0	8.0	Q3
DRV5056A3QDBZR	SOT-23	DBZ	3	3000	180.0	8.4	3.2	2.85	1.3	4.0	8.0	Q3
DRV5056A3QDBZR	SOT-23	DBZ	3	3000	180.0	8.4	3.2	2.85	1.3	4.0	8.0	Q3
DRV5056A4QDBZR	SOT-23	DBZ	3	3000	180.0	8.4	3.2	2.85	1.3	4.0	8.0	Q3
DRV5056A4QDBZR	SOT-23	DBZ	3	3000	180.0	8.4	3.2	2.85	1.3	4.0	8.0	Q3
DRV5056A6QDBZR	SOT-23	DBZ	3	3000	180.0	8.4	2.9	3.35	1.35	4.0	8.0	Q3
DRV5056A6QDBZR	SOT-23	DBZ	3	3000	180.0	8.4	3.15	2.77	1.22	4.0	8.0	Q3
DRV5056A6QDBZR	SOT-23	DBZ	3	3000	180.0	8.4	3.2	2.85	1.3	4.0	8.0	Q3
DRV5056A8QDBZR	SOT-23	DBZ	3	3000	180.0	8.4	3.2	2.85	1.3	4.0	8.0	Q3
DRV5056Z1QDBZR	SOT-23	DBZ	3	3000	180.0	8.4	3.2	2.85	1.3	4.0	8.0	Q3
DRV5056Z1QDBZR	SOT-23	DBZ	3	3000	180.0	8.4	3.2	2.85	1.3	4.0	8.0	Q3
DRV5056Z2QDBZR	SOT-23	DBZ	3	3000	180.0	8.4	3.2	2.85	1.3	4.0	8.0	Q3
DRV5056Z3QDBZR	SOT-23	DBZ	3	3000	180.0	8.4	3.2	2.85	1.3	4.0	8.0	Q3
DRV5056Z4QDBZR	SOT-23	DBZ	3	3000	180.0	8.4	3.2	2.85	1.3	4.0	8.0	Q3

Device	Package Type	Package Drawing	Pins	SPQ	Reel Diameter (mm)	Reel Width W1 (mm)	A0 (mm)	B0 (mm)	K0 (mm)	P1 (mm)	W (mm)	Pin1 Quadrant
DRV5056Z4QDBZR	SOT-23	DBZ	3	3000	180.0	8.4	3.2	2.85	1.3	4.0	8.0	Q3

**TAPE AND REEL BOX DIMENSIONS**

\*All dimensions are nominal

Device	Package Type	Package Drawing	Pins	SPQ	Length (mm)	Width (mm)	Height (mm)
DRV5056A1QDBZR	SOT-23	DBZ	3	3000	210.0	185.0	35.0
DRV5056A2QDBZR	SOT-23	DBZ	3	3000	210.0	185.0	35.0
DRV5056A2QDBZR	SOT-23	DBZ	3	3000	210.0	185.0	35.0
DRV5056A3QDBZR	SOT-23	DBZ	3	3000	210.0	185.0	35.0
DRV5056A3QDBZR	SOT-23	DBZ	3	3000	210.0	185.0	35.0
DRV5056A4QDBZR	SOT-23	DBZ	3	3000	210.0	185.0	35.0
DRV5056A4QDBZR	SOT-23	DBZ	3	3000	210.0	185.0	35.0
DRV5056A6QDBZR	SOT-23	DBZ	3	3000	210.0	185.0	35.0
DRV5056A6QDBZR	SOT-23	DBZ	3	3000	213.0	191.0	35.0
DRV5056A6QDBZR	SOT-23	DBZ	3	3000	210.0	185.0	35.0
DRV5056A8QDBZR	SOT-23	DBZ	3	3000	210.0	185.0	35.0
DRV5056Z1QDBZR	SOT-23	DBZ	3	3000	210.0	185.0	35.0
DRV5056Z1QDBZR	SOT-23	DBZ	3	3000	210.0	185.0	35.0
DRV5056Z2QDBZR	SOT-23	DBZ	3	3000	210.0	185.0	35.0
DRV5056Z3QDBZR	SOT-23	DBZ	3	3000	210.0	185.0	35.0
DRV5056Z4QDBZR	SOT-23	DBZ	3	3000	210.0	185.0	35.0
DRV5056Z4QDBZR	SOT-23	DBZ	3	3000	210.0	185.0	35.0

# DBZ0003A

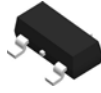

# PACKAGE OUTLINE

## SOT-23 - 1.12 mm max height

SMALL OUTLINE TRANSISTOR

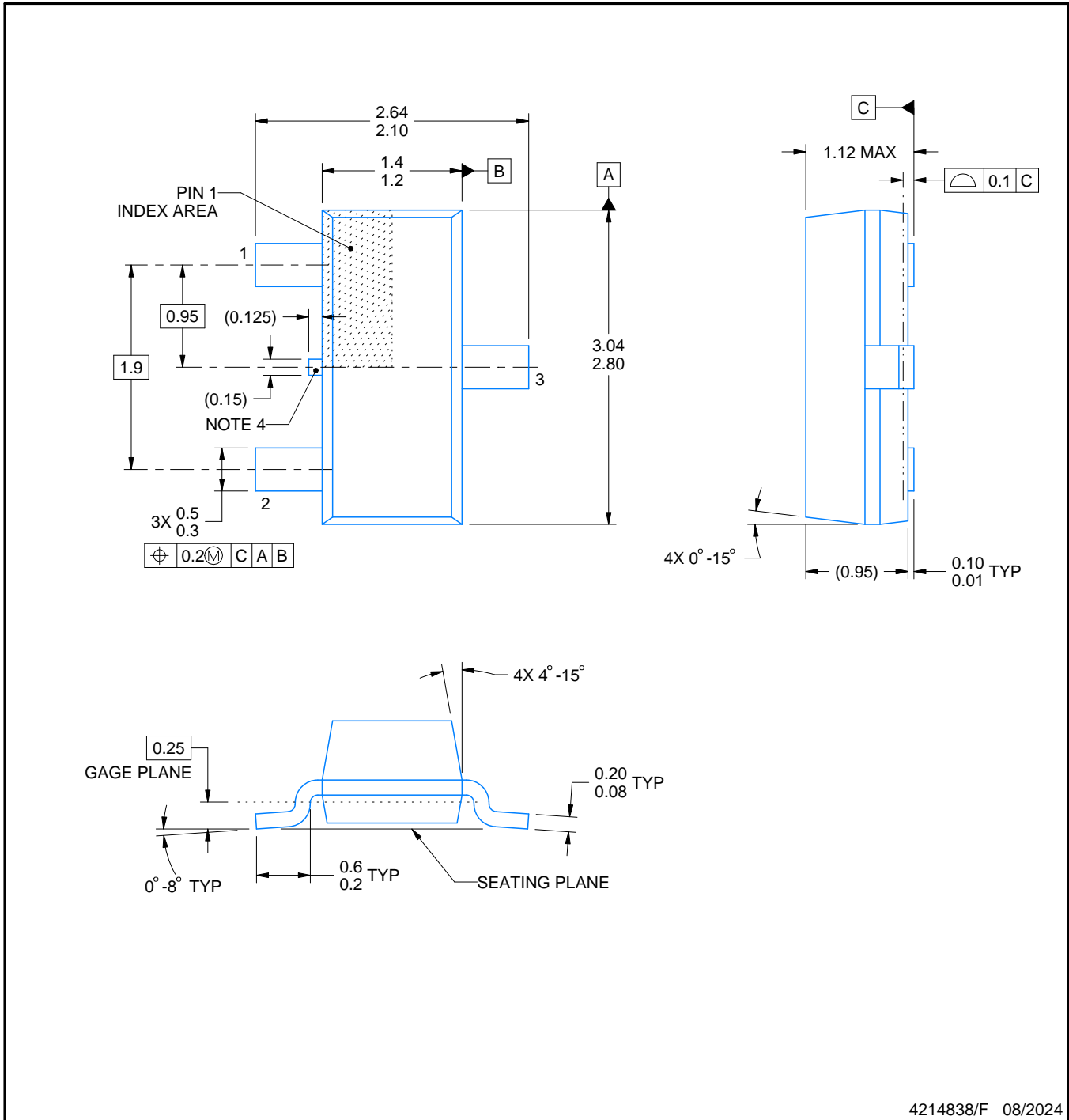

### NOTES:

1. All linear dimensions are in millimeters. Any dimensions in parenthesis are for reference only. Dimensioning and tolerancing per ASME Y14.5M.
2. This drawing is subject to change without notice.
3. Reference JEDEC registration TO-236, except minimum foot length.
4. Support pin may differ or may not be present.
5. Body dimensions do not include mold flash, protrusions, or gate burrs. Mold flash, protrusions, or gate burrs shall not exceed 0.25mm per side

# EXAMPLE BOARD LAYOUT

DBZ0003A

SOT-23 - 1.12 mm max height

SMALL OUTLINE TRANSISTOR

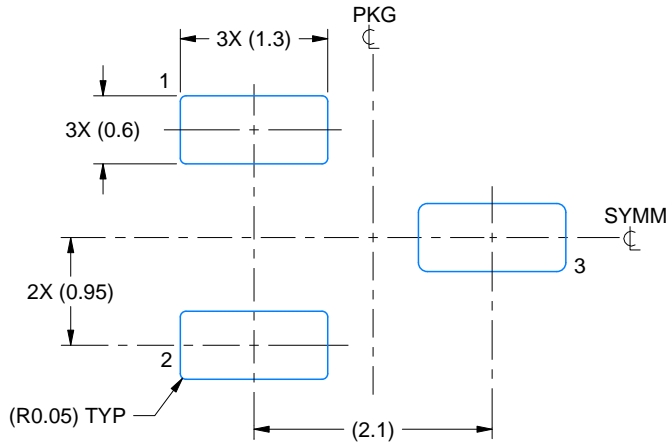

LAND PATTERN EXAMPLE  
SCALE:15X

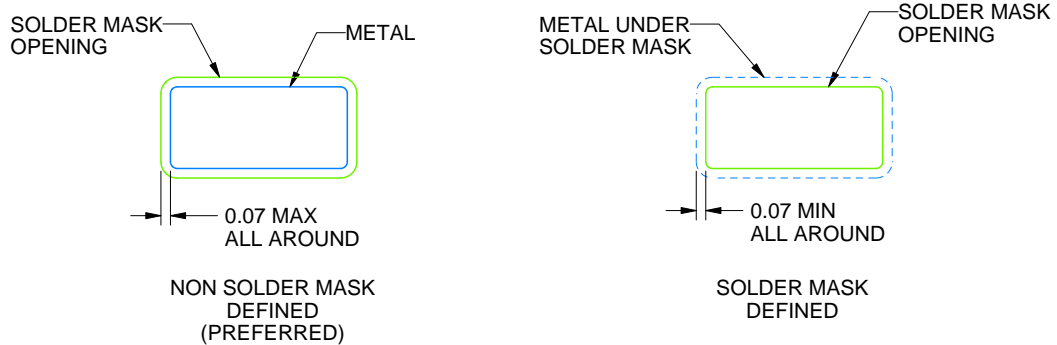

SOLDER MASK DETAILS

4214838/F 08/2024

NOTES: (continued)

- 5. Publication IPC-7351 may have alternate designs.
- 6. Solder mask tolerances between and around signal pads can vary based on board fabrication site.

# EXAMPLE STENCIL DESIGN

DBZ0003A

SOT-23 - 1.12 mm max height

SMALL OUTLINE TRANSISTOR

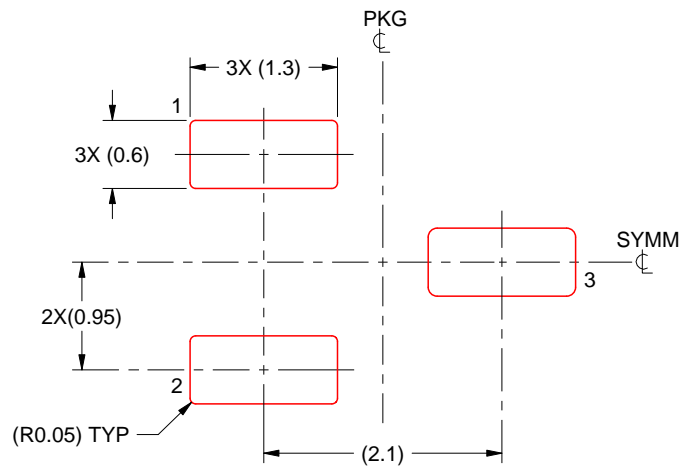

SOLDER PASTE EXAMPLE  
BASED ON 0.125 THICK STENCIL  
SCALE:15X

4214838/F 08/2024

NOTES: (continued)

7. Laser cutting apertures with trapezoidal walls and rounded corners may offer better paste release. IPC-7525 may have alternate design recommendations.
8. Board assembly site may have different recommendations for stencil design.



# LPG0003A



# PACKAGE OUTLINE

## TO-92 - 5.05 mm max height

TRANSISTOR OUTLINE

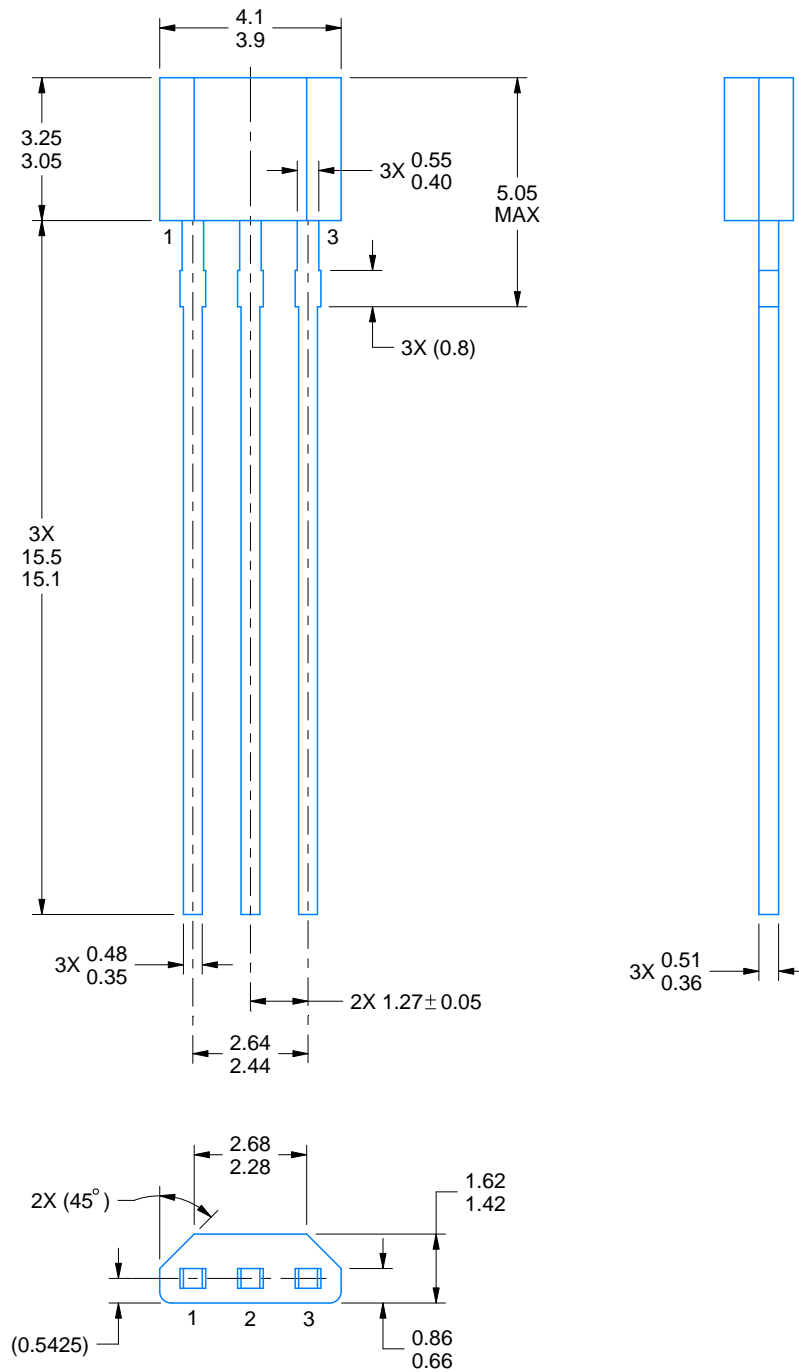

4221343/C 01/2018

### NOTES:

1. All linear dimensions are in millimeters. Any dimensions in parenthesis are for reference only. Dimensioning and tolerancing per ASME Y14.5M.
2. This drawing is subject to change without notice.

# EXAMPLE BOARD LAYOUT

LPG0003A

TO-92 - 5.05 mm max height

TRANSISTOR OUTLINE

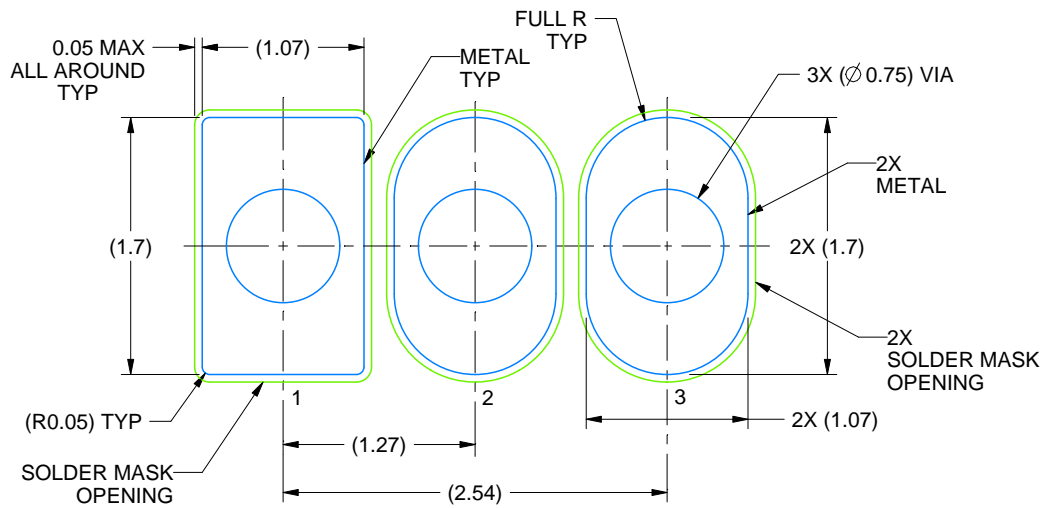

LAND PATTERN EXAMPLE  
NON-SOLDER MASK DEFINED  
SCALE:20X

4221343/C 01/2018

# TAPE SPECIFICATIONS

LPG0003A

TO-92 - 5.05 mm max height

TRANSISTOR OUTLINE

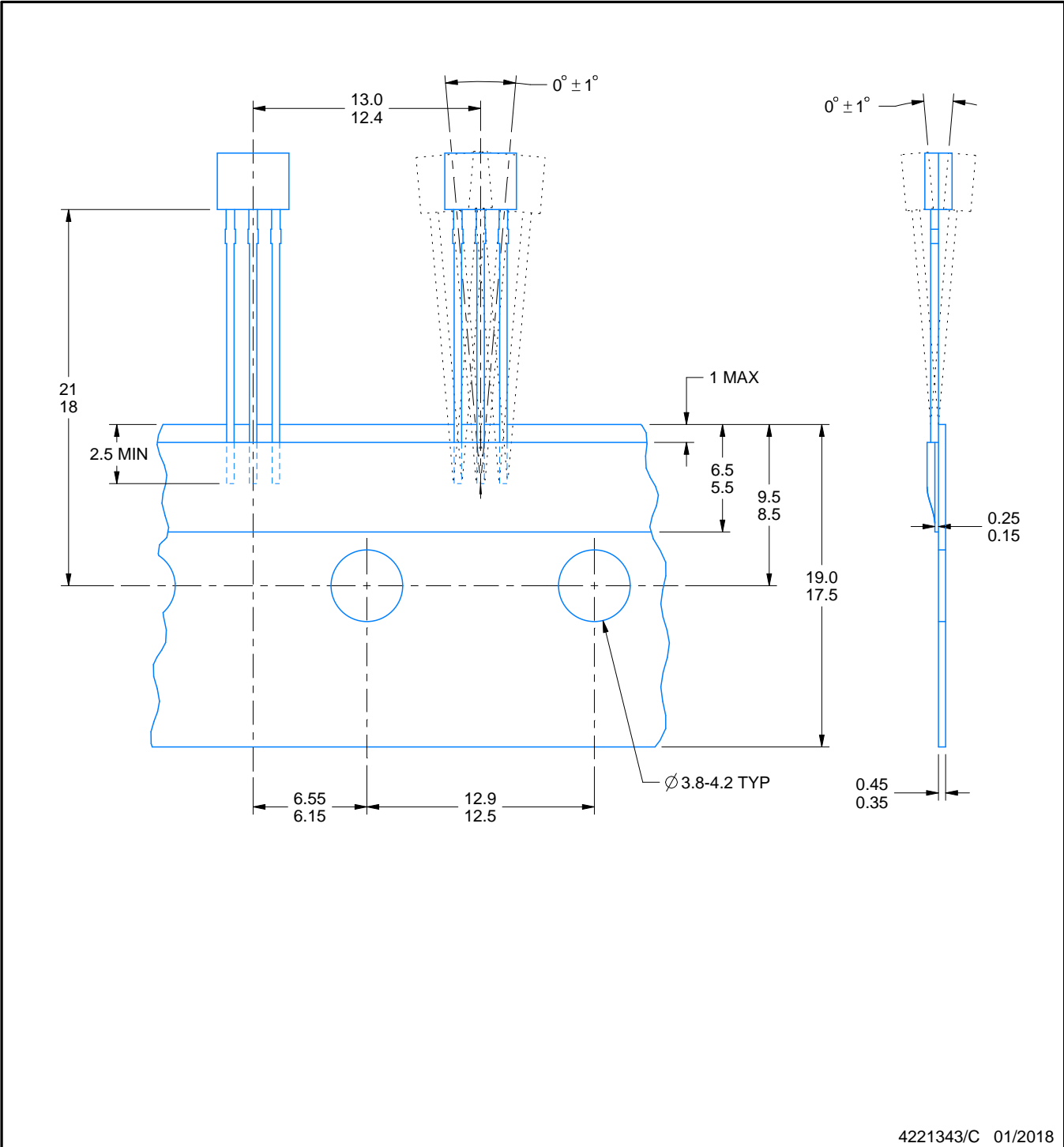

4221343/C 01/2018

## IMPORTANT NOTICE AND DISCLAIMER

TI PROVIDES TECHNICAL AND RELIABILITY DATA (INCLUDING DATASHEETS), DESIGN RESOURCES (INCLUDING REFERENCE DESIGNS), APPLICATION OR OTHER DESIGN ADVICE, WEB TOOLS, SAFETY INFORMATION, AND OTHER RESOURCES "AS IS" AND WITH ALL FAULTS, AND DISCLAIMS ALL WARRANTIES, EXPRESS AND IMPLIED, INCLUDING WITHOUT LIMITATION ANY IMPLIED WARRANTIES OF MERCHANTABILITY, FITNESS FOR A PARTICULAR PURPOSE OR NON-INFRINGEMENT OF THIRD PARTY INTELLECTUAL PROPERTY RIGHTS.

These resources are intended for skilled developers designing with TI products. You are solely responsible for (1) selecting the appropriate TI products for your application, (2) designing, validating and testing your application, and (3) ensuring your application meets applicable standards, and any other safety, security, regulatory or other requirements.

These resources are subject to change without notice. TI grants you permission to use these resources only for development of an application that uses the TI products described in the resource. Other reproduction and display of these resources is prohibited. No license is granted to any other TI intellectual property right or to any third party intellectual property right. TI disclaims responsibility for, and you fully indemnify TI and its representatives against any claims, damages, costs, losses, and liabilities arising out of your use of these resources.

TI's products are provided subject to [TI's Terms of Sale](#), [TI's General Quality Guidelines](#), or other applicable terms available either on [ti.com](http://ti.com) or provided in conjunction with such TI products. TI's provision of these resources does not expand or otherwise alter TI's applicable warranties or warranty disclaimers for TI products. Unless TI explicitly designates a product as custom or customer-specified, TI products are standard, catalog, general purpose devices.

TI objects to and rejects any additional or different terms you may propose.

Copyright © 2025, Texas Instruments Incorporated

Last updated 10/2025