

16-Bit, 80/105/135-MSPS Analog-to-Digital Converters

Check for Samples: [ADS5481](#) [ADS5482](#) [ADS5483](#)

FEATURES

- 80/105/135-MSPS Sample Rates
- 16-Bit Resolution
- SFDR: 95 dBc at 70 MHz and 135 MSPS
- SNR: 78.6 dBFS at 70 MHz and 135 MSPS
- Efficient DDR LVDS-Compatible Outputs
- Internal Dither Available
- Total Power Dissipation: 2.2 W
- Power-Down Mode: 70 mW
- On-Chip High Impedance Analog Buffer
- QFN-64 PowerPAD™ Package (9 mm × 9 mm Footprint)
- Industrial Temperature Range: –40°C to +85°C

APPLICATIONS

- Wireless Infrastructure (Multi-Carrier GSM, WCDMA, LTE)
- Test and Measurement Instrumentation
- Software-Defined Radio
- Data Acquisition
- Power Amplifier Linearization
- Communication Instrumentation
- Radar
- Medical Imaging

DESCRIPTION

The ADS5481/ADS5482/ADS5483 (ADS548x) is a 16-bit family of analog-to-digital converters (ADCs) that operate from both a 5-V supply and 3.3-V supply while providing LVDS-compatible digital outputs. The ADS548x integrated analog input buffer isolates the internal switching of the onboard track and hold (T&H) from disturbing the signal source while providing a high-impedance input. An internal reference generator is also provided to simplify the system design.

Designed for highest total ENOB, the ADS548x family has outstanding low noise performance and spurious-free dynamic range.

The ADS548x is available in an QFN-64 PowerPAD package. The device is built on Texas Instruments complementary bipolar process (BiCom3) and is specified over the full industrial temperature range (–40°C to +85°C).

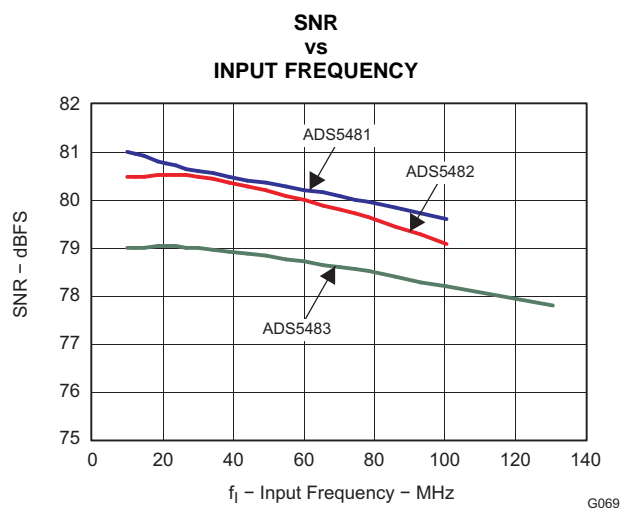
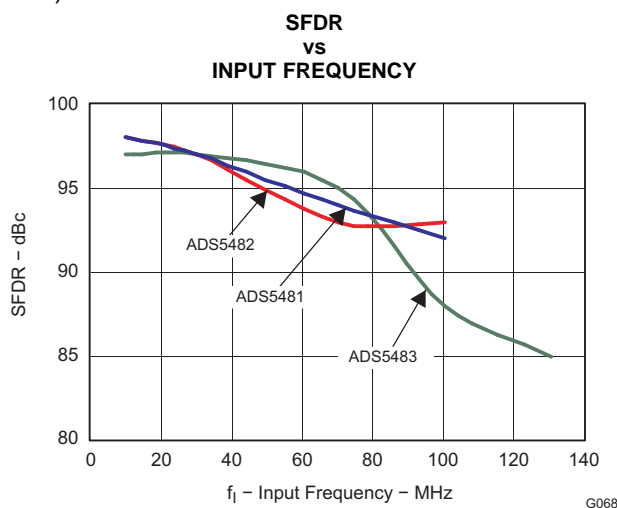

Please be aware that an important notice concerning availability, standard warranty, and use in critical applications of Texas Instruments semiconductor products and disclaimers thereto appears at the end of this data sheet.

PowerPAD is a trademark of Texas Instruments.

All other trademarks are the property of their respective owners.



This integrated circuit can be damaged by ESD. Texas Instruments recommends that all integrated circuits be handled with appropriate precautions. Failure to observe proper handling and installation procedures can cause damage.

ESD damage can range from subtle performance degradation to complete device failure. Precision integrated circuits may be more susceptible to damage because very small parametric changes could cause the device not to meet its published specifications.

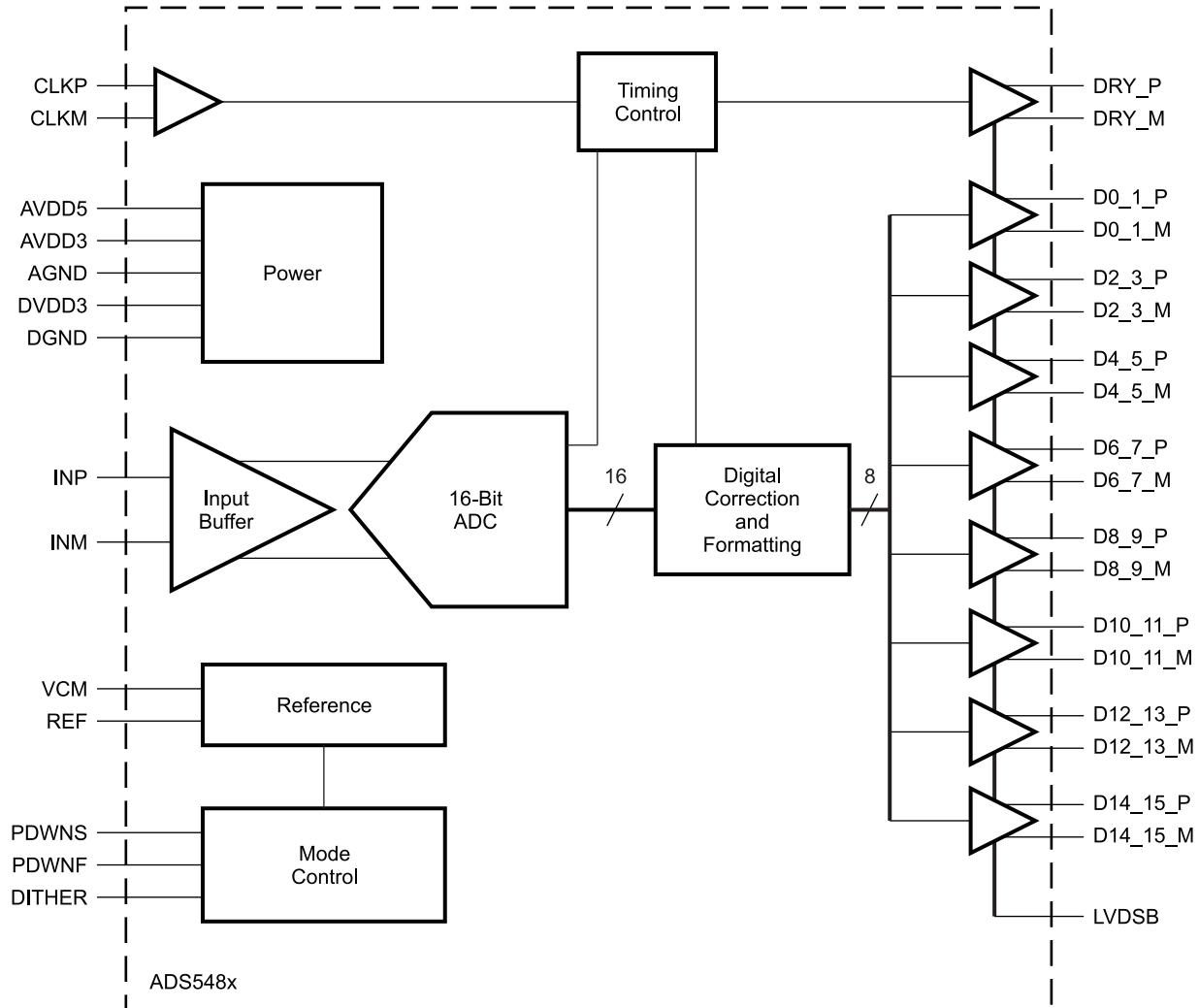

B0095-03

Table 1. PACKAGE/ORDERING INFORMATION⁽¹⁾

PRODUCT	PACKAGE-LEAD	PACKAGE DESIGNATOR	SPECIFIED TEMPERATURE RANGE	PACKAGE MARKING	ORDERING NUMBER	TRANSPORT MEDIA, QUANTITY
ADS5481	QFN-64	RGC	-40°C to +85°C	AZ5481	ADS5481IRGCT	Tape and Reel, 250
					ADS5481IRGCR	Tape and Reel, 2000
ADS5482	QFN-64	RGC	-40°C to +85°C	AZ5482	ADS5482IRGCT	Tape and Reel, 250
					ADS5482IRGCR	Tape and Reel, 2000
ADS5483	QFN-64	RGC	-40°C to +85°C	AZ5483	ADS5483IRGCT	Tape and Reel, 250
					ADS5483IRGCR	Tape and Reel, 2000

(1) For the most current product and ordering information see the Package Option Addendum located at the end of this document, or see the TI website at www.ti.com..

ABSOLUTE MAXIMUM RATINGS⁽¹⁾

Over operating free-air temperature range, unless otherwise noted.

		ADS5481, ADS5482, ADS5483	UNIT
Supply voltage	AVDD5 to GND	6	V
	AVDD3 to GND	5	V
	DVDD3 to GND	5	V
Analog input to GND	AC signal. Valid when AVDD5 is within normal operating range. When AVDD5 is off, analog inputs should be <0.5V. If not, the protection diode between the inputs and AVDD5 will become forward-biased and could be damaged or shorten device lifetime (see Figure 60). Short transient conditions during power on/off are not a concern.	–0.3 to (AVDD5 + 0.3)	V
Analog INP to INM	DC signal	±4	V
Clock input to GND	Valid when AVDD3 is within normal operating range. When AVDD3 is off, clock inputs should be <0.5V. If not, the protection diode between the inputs and AVDD3 will become forward-biased and could be damaged or shorten device lifetime (see Figure 67). Short transient conditions during power on/off are not a concern.	–0.3 to (AVDD3 + 0.3)	V
CLKP to CLKM		±2.5	V
Digital data output to GND		–0.3 to (DVDD3 + 0.3)	V
Digital data output plus-to-minus		±1	V
Operating temperature range		–40 to +85	°C
Maximum junction temperature		+150	°C
Storage temperature range		–65 to +150	°C
ESD, human-body model (HBM)		2	kV

- (1) Stresses above these ratings may cause permanent damage. Exposure to absolute maximum conditions for extended periods may degrade device reliability. These are stress ratings only, and functional operation of the device at these or any other conditions beyond those specified is not implied. Kirkendall voidings and current density information for calculation of expected lifetime are available upon request.

THERMAL CHARACTERISTICS⁽¹⁾

PARAMETER	TEST CONDITIONS	TYP	UNIT
R _{θJA}	Soldered thermal pad, no airflow	20	°C/W
	Soldered thermal pad, 150-LFM airflow	16	
R _{θJC}	thermal resistance from the junction to the package case (top)	7	
R _{θJP}	thermal resistance from the junction to the thermal pad (bottom)	0.2	

- (1) Using 49 thermal vias (7 × 7 array). See *PowerPAD Package* in the Application Information section.

RECOMMENDED OPERATING CONDITIONS

		ADS5481, ADS5482, ADS5483			UNIT
		MIN	TYP	MAX	
SUPPLIES					
AVDD5	Analog supply voltage	4.75	5	5.25	V
AVDD3	Analog supply voltage	3.1	3.3	3.6	V
DVDD3	Output driver supply voltage	3	3.3	3.6	V
ANALOG INPUT					
	Differential input range	3			V _{PP}
VCM	Input common mode	3.1			V
DIGITAL OUTPUT (DRY, DATA)					
	Maximum differential output load (parasitic or intentional)	5			pF
	Differential output resistance	100			Ω
CLOCK INPUT (CLK)					
	CLK input sample rate (sine wave)	10		Max Rated Clock	MSPS
	Clock amplitude, differential sine wave (see Figure 69)	1.5		5	V _{PP}
	Clock duty cycle (see Figure 74)	45	50	55	%
T _A	Operating free-air temperature	-40		+85	°C

ELECTRICAL CHARACTERISTICS (ADS5481, ADS5482, ADS5483)

Typical values at T_A = +25°C: minimum and maximum values over full temperature range T_{MIN} = -40°C to T_{MAX} = +85°C, sampling rate = max rated, 50% clock duty cycle, AVDD5 = 5 V, AVDD3 = 3.3 V, DVDD3 = 3.3 V, -1 dBFS differential input, and 3-V_{PP} differential clock, unless otherwise noted.

PARAMETER	TEST CONDITIONS	ADS5481			ADS5482			ADS5483			UNIT		
		MIN	TYP	MAX	MIN	TYP	MAX	MIN	TYP	MAX			
Clock rate				80			105			135	MSPS		
Resolution				16			16			16	Bits		
ANALOG INPUTS													
	Differential input range			3			3			3	V _{PP}		
	Analog input common-mode voltage			3.1			3.1			3.1	V		
	Input resistance (dc)			1000			1000			1000	Ω		
	Input capacitance			3.5			3.5			3.5	pF		
	Analog input bandwidth (-3dB)			125			125			485	MHz		
CMRR	Common-mode rejection ratio			65			65			65	dB		
INTERNAL REFERENCE VOLTAGE													
VREF	Reference voltage			1.2			1.2			1.2	V		
VCM	Analog input common-mode voltage reference output			3	3.15	3.35	3	3.15	3.35	3	3.15	3.35	V
	VCM temperature coefficient			-1			-1			-1	mV/°C		

ELECTRICAL CHARACTERISTICS (ADS5481, ADS5482, ADS5483) (continued)

Typical values at $T_A = +25^\circ\text{C}$: minimum and maximum values over full temperature range $T_{\text{MIN}} = -40^\circ\text{C}$ to $T_{\text{MAX}} = +85^\circ\text{C}$, sampling rate = max rated, 50% clock duty cycle, AVDD5 = 5 V, AVDD3 = 3.3 V, DVDD3 = 3.3 V, -1 dBFS differential input, and $3\text{-}V_{\text{PP}}$ differential clock, unless otherwise noted.

PARAMETER		TEST CONDITIONS	ADS5481			ADS5482			ADS5483			UNIT
			MIN	TYP	MAX	MIN	TYP	MAX	MIN	TYP	MAX	
DYNAMIC ACCURACY												
DNL	Differential linearity error	No missing codes, $f_{\text{IN}} = 30$ MHz	-0.99	± 0.5	1.0	-0.99	± 0.5	1.0	-0.99	± 0.5	1.0	LSB
INL	Integral linearity error	$f_{\text{IN}} = 30$ MHz	-10	± 3	+10	-10	± 3	+10	-10	± 3	+10	LSB
	Offset error		-15		15	-15		15	-15		15	mV
	Offset temperature coefficient		-0.02			-0.02			-0.02			mV/ $^\circ\text{C}$
	Gain error		-6	± 2	6	-6	± 2	6	-6	± 2	6	%FS
	Gain temperature coefficient		-0.01			-0.01			-0.01			mV/ $^\circ\text{C}$
POWER SUPPLY												
I_{AVDD5}	5-V analog	$V_{\text{IN}} = \text{full-scale,}$ $f_{\text{IN}} = 30$ MHz, $f_{\text{S}} = \text{Max rated, Normal}$ operation	316	330		316	330		317	330		mA
I_{AVDD3}	3.3-V analog		131	150		131	150		133	150		mA
I_{DVDD3}	3.3-V digital/LVDS		60	65		60	65		60	65		mA
	Total power dissipation		2.15	2.35		2.15	2.35		2.2	2.35		W
I_{AVDD5}	5-V analog	Light sleep mode (PDWNF=H, PDWNS=L)	98			98			98			mA
I_{AVDD3}	3.3-V analog		35			35			35			mA
I_{DVDD3}	3.3-V digital/LVDS		0.07			0.07			0.07			mA
	Total power dissipation		605	680		680	680		605	680		mW
I_{AVDD5}	5-V analog	Deep sleep mode (PDWNF=L, PDWNS=H)	13			13			13			mA
I_{AVDD3}	3.3-V analog		2			2			2			mA
I_{DVDD3}	3.3-V digital/LVDS		0.07			0.07			0.07			mA
	Total power dissipation		70	100		70	100		70	100		mW
	Fast wakeup time (light sleep)	From PDWNF disabled	600			600			600			μS
	Slow wakeup time (deep sleep)	From PDWNS disabled	6			6			6			mS
PSRR	AVDD5 supply	Power-supply rejection ratio, Without 0.1- μF board supply capacitors, with 1-MHz supply noise (see Figure 76)	60			60			60			dB
	AVDD3 supply		80			80			80			dB
	DVDD3 supply		95			95			95			dB
DYNAMIC AC CHARACTERISTICS												
SNR	Signal-to-noise ratio	$f_{\text{IN}} = 10$ MHz	81			80.8			79			dBFS
		$f_{\text{IN}} = 30$ MHz	78.4	80.6		78.4	80.7		76	79		
		$f_{\text{IN}} = 70$ MHz	80.1			80.1			78.6			
		$f_{\text{IN}} = 100$ MHz	79.6			80			78.2			
		$f_{\text{IN}} = 130$ MHz							77.8			
SFDR	Spurious-free dynamic range	$f_{\text{IN}} = 10$ MHz	98			98			97			dBc
		$f_{\text{IN}} = 30$ MHz	87	97		87	98		86	97		
		$f_{\text{IN}} = 70$ MHz	93			91			95			
		$f_{\text{IN}} = 100$ MHz	92			90			88			
		$f_{\text{IN}} = 130$ MHz							85			
HD2	Second-harmonic	$f_{\text{IN}} = 10$ MHz	108			107			102			dBc
		$f_{\text{IN}} = 30$ MHz	87	101		87	105		86	99		
		$f_{\text{IN}} = 70$ MHz	100			101			95			
		$f_{\text{IN}} = 100$ MHz	99			100			92			
		$f_{\text{IN}} = 130$ MHz							85			

ELECTRICAL CHARACTERISTICS (ADS5481, ADS5482, ADS5483) (continued)

Typical values at $T_A = +25^\circ\text{C}$: minimum and maximum values over full temperature range $T_{\text{MIN}} = -40^\circ\text{C}$ to $T_{\text{MAX}} = +85^\circ\text{C}$, sampling rate = max rated, 50% clock duty cycle, AVDD5 = 5 V, AVDD3 = 3.3 V, DVDD3 = 3.3 V, -1 dBFS differential input, and $3\text{-}V_{\text{PP}}$ differential clock, unless otherwise noted.

PARAMETER	TEST CONDITIONS	ADS5481			ADS5482			ADS5483			UNIT												
		MIN	TYP	MAX	MIN	TYP	MAX	MIN	TYP	MAX													
HD3	Third-harmonic	$f_{\text{IN}} = 10 \text{ MHz}$			103			96			110			dBc									
		$f_{\text{IN}} = 30 \text{ MHz}$			87			100			87				98			86			100		
		$f_{\text{IN}} = 70 \text{ MHz}$			93			91			96												
		$f_{\text{IN}} = 100 \text{ MHz}$			92			90			88												
		$f_{\text{IN}} = 130 \text{ MHz}$									88												
	Worst harmonic/spur (other than HD2 and HD3)	$f_{\text{IN}} = 10 \text{ MHz}$			98			98			97			dBc									
		$f_{\text{IN}} = 30 \text{ MHz}$			87			97			86				97								
		$f_{\text{IN}} = 70 \text{ MHz}$			96			97			98												
		$f_{\text{IN}} = 100 \text{ MHz}$			96			94			97												
		$f_{\text{IN}} = 130 \text{ MHz}$									96												
THD	Total harmonic distortion	$f_{\text{IN}} = 10 \text{ MHz}$			96			95			97			dBc									
		$f_{\text{IN}} = 30 \text{ MHz}$			84			94			84				95			83			94		
		$f_{\text{IN}} = 70 \text{ MHz}$			93			88			91												
		$f_{\text{IN}} = 100 \text{ MHz}$			88			92			86												
		$f_{\text{IN}} = 130 \text{ MHz}$									83												
SINAD	Signal-to-noise and distortion	$f_{\text{IN}} = 10 \text{ MHz}$			80			79.5			77.9			dBc									
		$f_{\text{IN}} = 30 \text{ MHz}$			76.7			79.5			76.7				79.3			74			77.8		
		$f_{\text{IN}} = 70 \text{ MHz}$			78.9			78.2			77.4												
		$f_{\text{IN}} = 100 \text{ MHz}$			77.8			78			76.6												
		$f_{\text{IN}} = 130 \text{ MHz}$									76												
IMD	Two-tone SFDR	$f_{\text{IN1}} = 29.5 \text{ MHz}, f_{\text{IN2}} = 30.5 \text{ MHz}$, each at -7 dBFS, worst spur			103			101			100			dBFS									
		$f_{\text{IN1}} = 102 \text{ MHz}, f_{\text{IN2}} = 103 \text{ MHz}$, each at -7 dBFS, worst spur									90												
ENOB	Effective number of bits	$f_{\text{IN}} = 10 \text{ MHz}$ (from SINAD in dBc)			13			12.9			12.64			Bits									
		$f_{\text{IN}} = 30 \text{ MHz}$ (from SINAD in dBc)			12.4			12.9			12.4				12.88			12			12.63		
	RMS idle-channel noise	Analog inputs shorted together			1.8			1.8			2.2			LSBrms									
LVDS DIGITAL OUTPUTS																							
V_{OD}	Differential output voltage (\pm)	Assumes a 100 Ω differential load on each LVDS pair and LVDS bias = 3.5 mA			247	350	454	247	350	454	247	350	454	mV									
V_{OC}	Common-mode output voltage				1.125	1.375	1.125	1.375	1.125	1.375	1.125	1.375	V										
DIGITAL INPUTS																							
V_{IH}	High level input voltage				2.0			2.0			2.0			V									
V_{IL}	Low level input voltage				0.8			0.8			0.8			V									
I_{IH}	High level input current	PDWNF, PDWNS, DITHER			1			1			1			μA									
I_{IL}	Low level input current				-1			-1			-1			μA									
	Input capacitance				2			2			2			pF									

TIMING INFORMATION

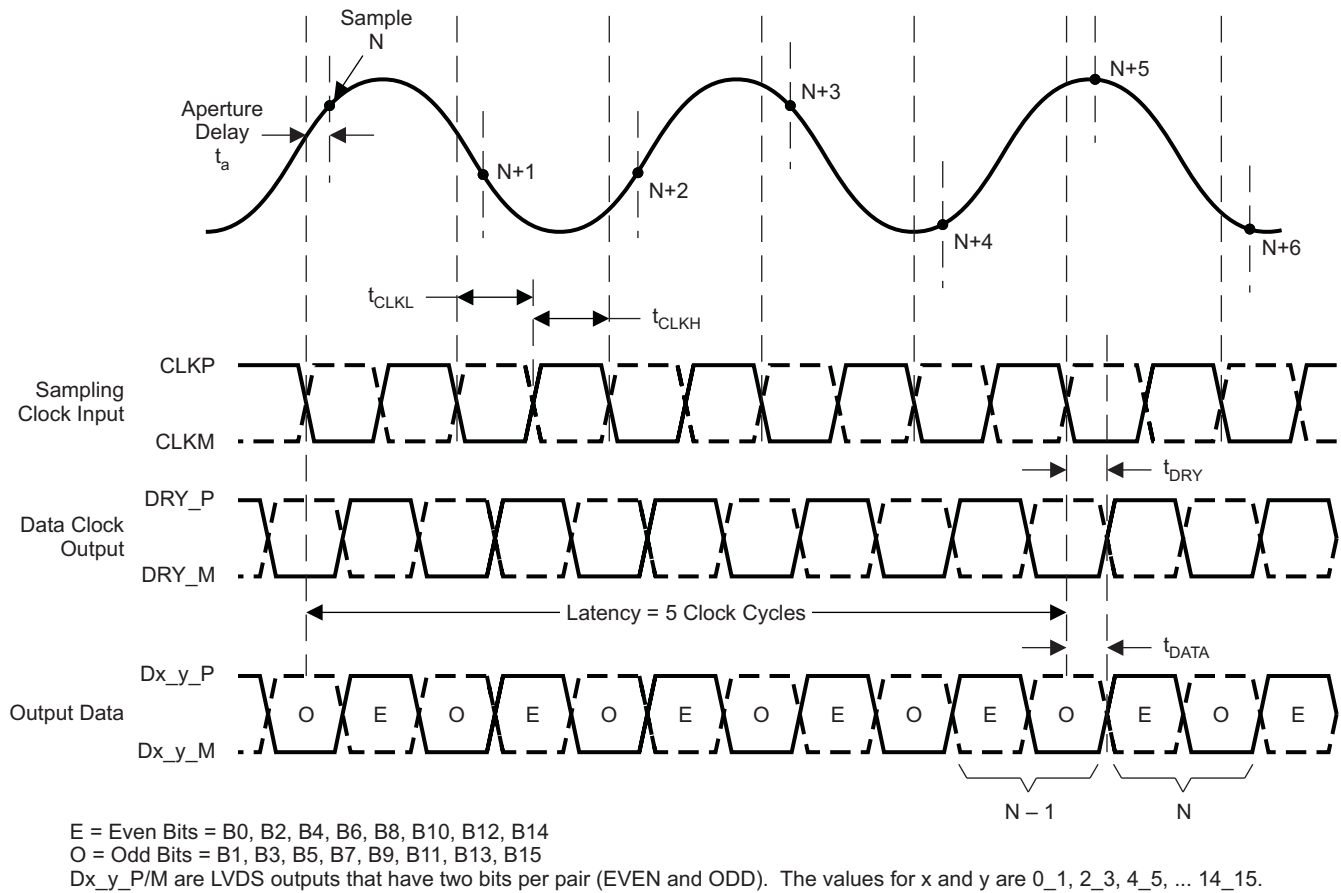

T0158-02

Figure 1. Timing Diagram

TIMING CHARACTERISTICS⁽¹⁾

Typical values at $T_A = +25^\circ\text{C}$: minimum and maximum values over full temperature range $T_{\text{MIN}} = -40^\circ\text{C}$ to $T_{\text{MAX}} = +85^\circ\text{C}$, sampling rate = max rated, 50% clock duty cycle, AVDD5 = 5 V, AVDD3 = 3.3 V, DVDD3 = 3.3 V, and 3-V_{PP} differential clock, unless otherwise noted.

PARAMETER	TEST CONDITIONS	MIN	TYP	MAX	UNIT
t_a	Aperture delay		200		ps
	Aperture jitter, rms	Internal jitter of the ADC		80	fs
	Latency		5		cycles
t_{CLK}	Clock period	$1e9/\text{CLK}$		100	ns
t_{CLKH}	Clock pulse duration, high	CLK = max rated clock for that part number		50	ns
t_{CLKL}	Clock pulse duration, low	$0.5e9/\text{CLK}$		50	ns
t_{DRY}	CLK to DRY delay ⁽²⁾	1500	1900	2300	ps
t_{DATA}	CLK to DATA delay ⁽²⁾	Zero crossing, 5-pF parasitic to GND		2400	ps
t_{SKEW}	DATA to DRY skew	$t_{\text{DATA}} - t_{\text{DRY}}$, 5-pF parasitic to GND		600	ps
t_{RISE}	DRY/DATA rise time	5-pF parasitic to GND		500	ps
t_{FALL}	DRY/DATA fall time			500	ps

(1) Timing parameters are assured by design or characterization, but not production tested.

(2) DRY and DATA are updated on the rising edge of CLK input. The latency must be added to t_{DATA} to determine the overall propagation delay.

PIN CONFIGURATION

ADS548x
 RGC Package
 (Top View)

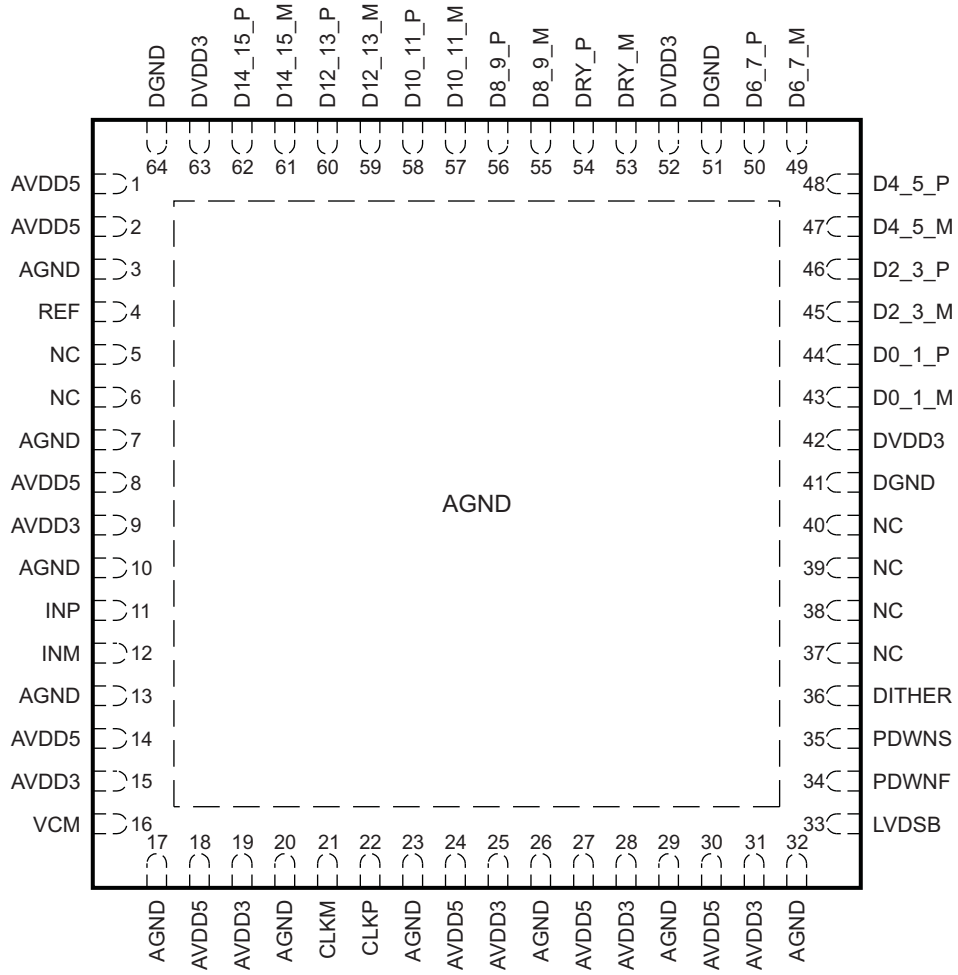

P0056-08

Table 2. TERMINAL FUNCTIONS

TERMINAL		DESCRIPTION
NAME	NO.	
AVDD5	1, 2, 8, 14, 18, 24, 27, 30	5V analog supply
AVDD3	9, 15, 19, 25, 28, 31	3.3V analog supply
AGND	3, 7, 10, 13, 17, 20, 23, 26, 29, 32	Analog ground
DVDD3	42, 52, 63	3.3V digital supply
DGND	41, 51, 64	Digital ground
NC	5, 6, 37-40	No connects - leave floating
INP, INM	11, 12	Differential analog inputs (P = plus = true, M = minus = complement)
CLKM, CLKP	21, 22	Differential clock inputs (P = plus = true, M = minus = complement)
REF	4	Reference voltage input/output (1.2V nominal). To use an external reference and to turn the internal reference off, pull both PDWNF and PDWNS to logic high (DVDD3).
VCM	16	Analog input common mode, output (3.1V), for use in applications that require use of the internally generated common-mode. See the applications section for more information on using VCM.
LVDSB	33	External bias resistor for LVDS bias current, normally 10kΩ to GND to provide nominal 3.5mA LVDS current
PDWNF	34	Light sleep power down, fast wakeup, logic high (DVDD3) = light sleep enabled (bandgap reference remains on)
PDWNS	35	Deep sleep power down, slow wakeup, logic high (DVDD3) = deep sleep enabled (bandgap reference is off)
DITHER	36	Dither enable, logic high (DVDD3) = dither enabled
DRY_P, DRY_M	54, 53	Dataready signal (LVDS clockout) (P = plus = true, M = minus = complement)
D14_15_P, D14_15_M	62, 61	DDR LVDS output bits 14 then 15 (15 is MSB) (P = plus = true, M = minus = complement)
DE_O_P, DE_O_M	43-50, 55-62	DDR LVDS output bits E (even) then O (odd) (P = plus = true, M = minus = complement)
D0_1_P, D0_1_M	44, 43	DDR LVDS output bits 0 then 1 (0 is LSB) (P = plus = true, M = minus = complement)
PowerPAD	65	Analog ground (exposed pad on bottom of package)

TYPICAL CHARACTERISTICS

At $T_A = +25^\circ\text{C}$, sampling rate = max rated, 50% clock duty cycle, $3\text{-}V_{PP}$ differential sinusoidal clock, analog input amplitude = -1 dBFS , $AVDD5 = 5\text{ V}$, $AVDD3 = 3.3\text{ V}$, and $DVDD3 = 3.3\text{ V}$, unless otherwise noted.

ADS5481 - 80 MSPS Typical Data

Plots in this section are with a clock of 80MSPS unless otherwise specified.

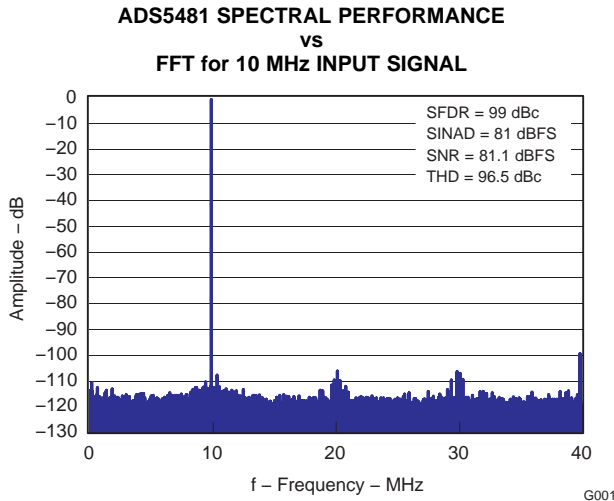

Figure 2.

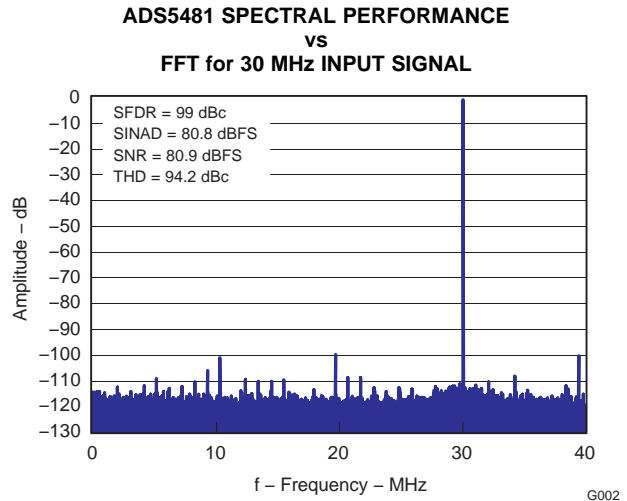

Figure 3.

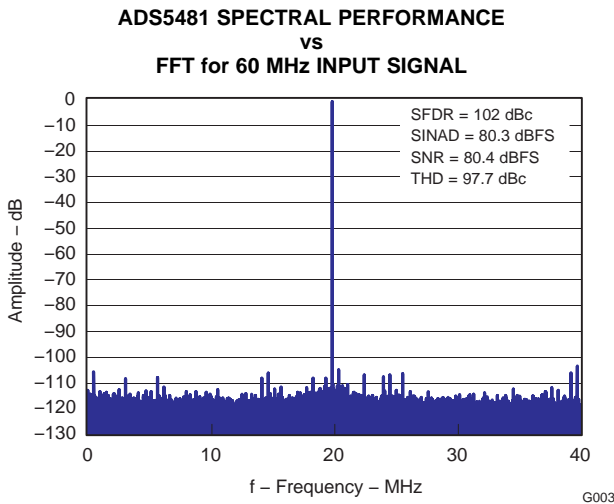

Figure 4.

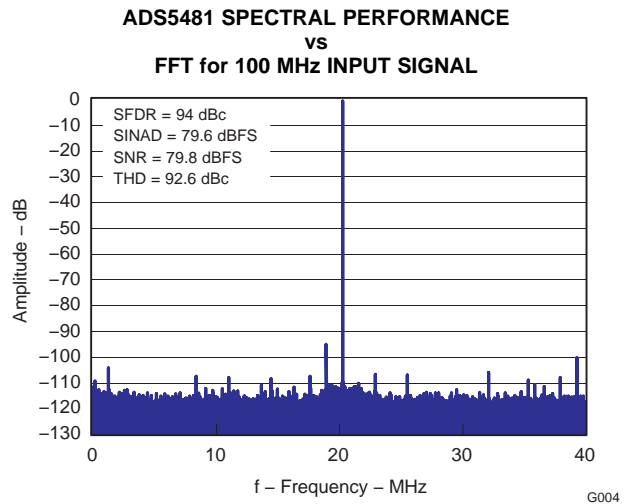

Figure 5.

TYPICAL CHARACTERISTICS (continued)

At $T_A = +25^\circ\text{C}$, sampling rate = max rated, 50% clock duty cycle, 3- V_{PP} differential sinusoidal clock, analog input amplitude = -1 dBFS, AVDD5 = 5 V, AVDD3 = 3.3 V, and DVDD3 = 3.3 V, unless otherwise noted.

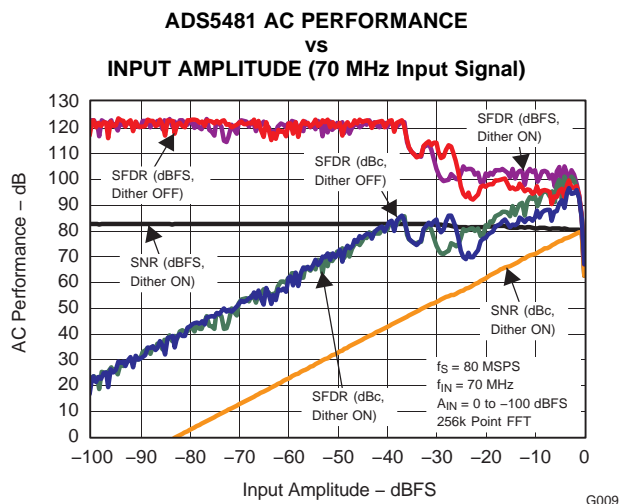

Figure 6.

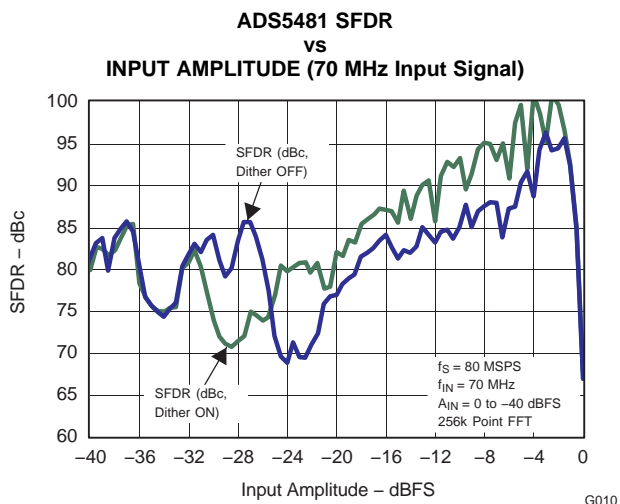

Figure 7.

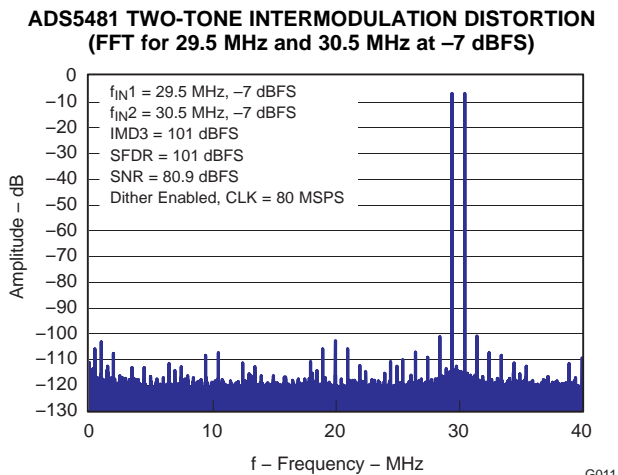

Figure 8.

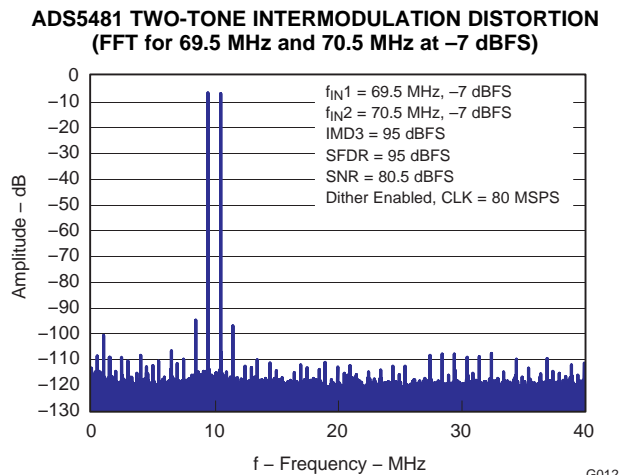

Figure 9.

TYPICAL CHARACTERISTICS (continued)

At $T_A = +25^\circ\text{C}$, sampling rate = max rated, 50% clock duty cycle, 3- V_{PP} differential sinusoidal clock, analog input amplitude = -1 dBFS, AVDD5 = 5 V, AVDD3 = 3.3 V, and DVDD3 = 3.3 V, unless otherwise noted.

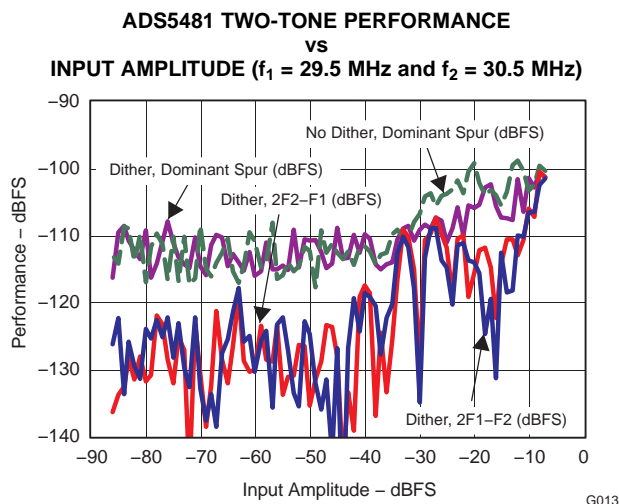

Figure 10.

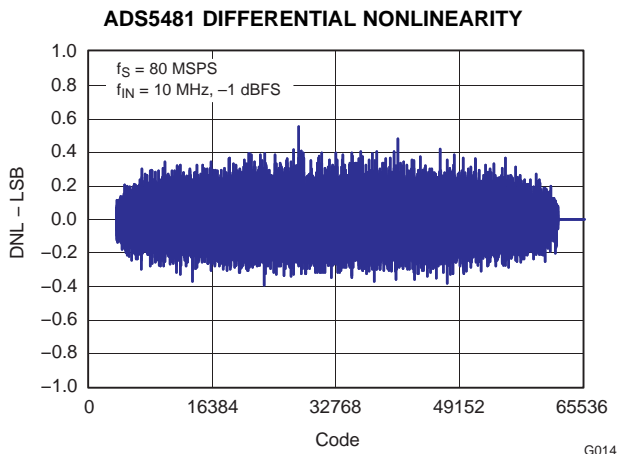

Figure 11.

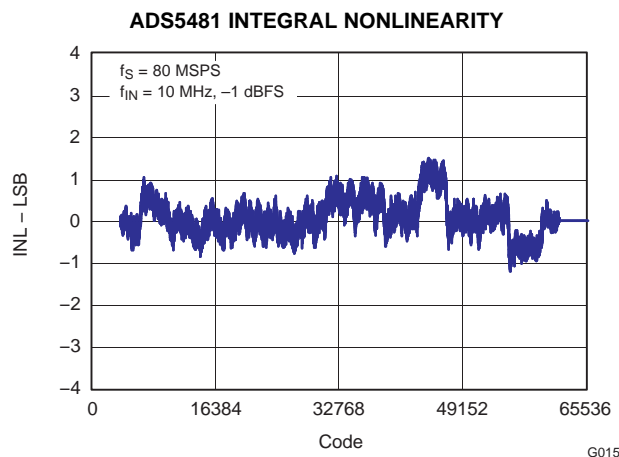

Figure 12.

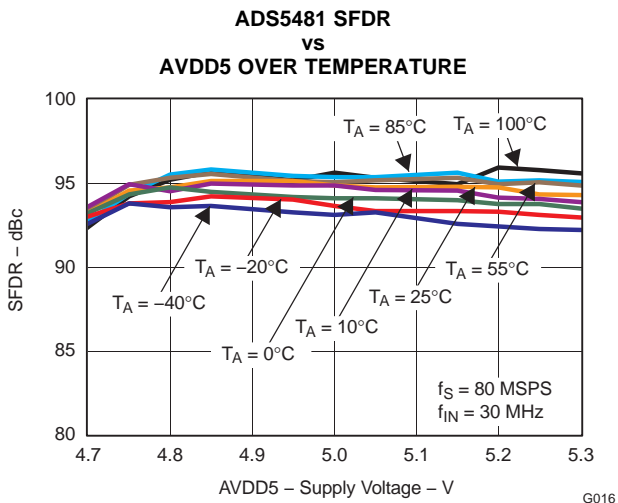

Figure 13.

TYPICAL CHARACTERISTICS (continued)

At $T_A = +25^\circ\text{C}$, sampling rate = max rated, 50% clock duty cycle, 3- V_{PP} differential sinusoidal clock, analog input amplitude = -1 dBFS, AVDD5 = 5 V, AVDD3 = 3.3 V, and DVDD3 = 3.3 V, unless otherwise noted.

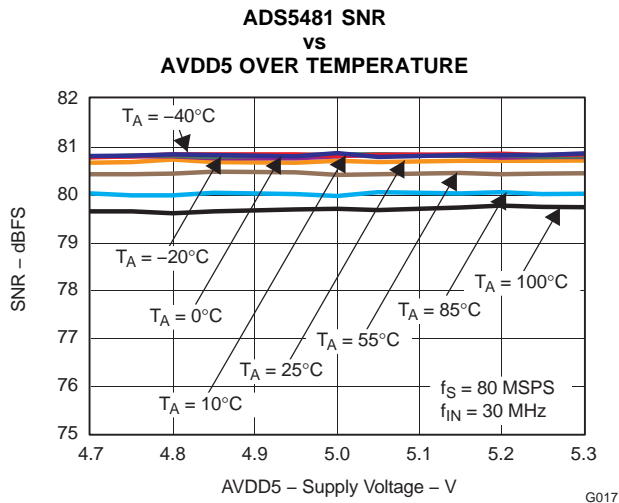

Figure 14.

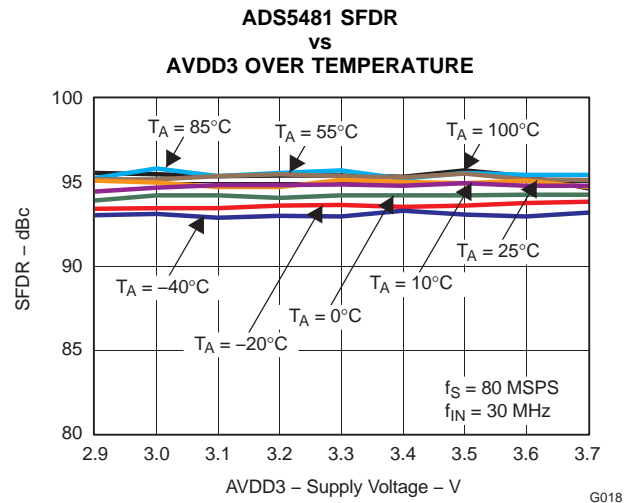

Figure 15.

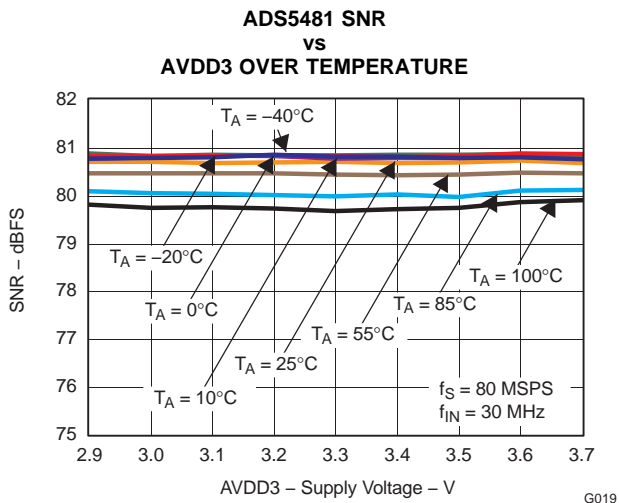

Figure 16.

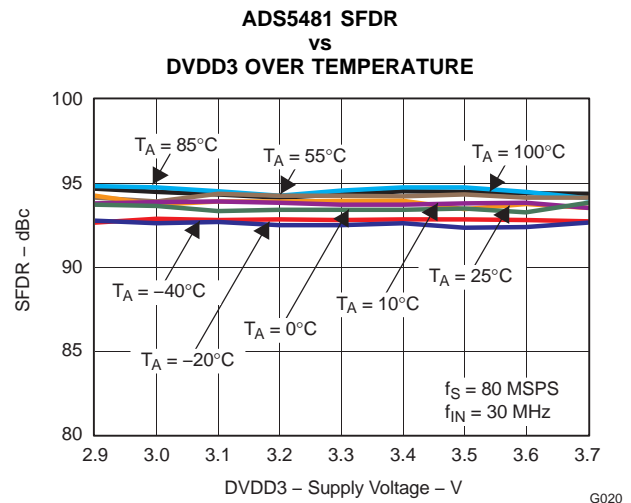
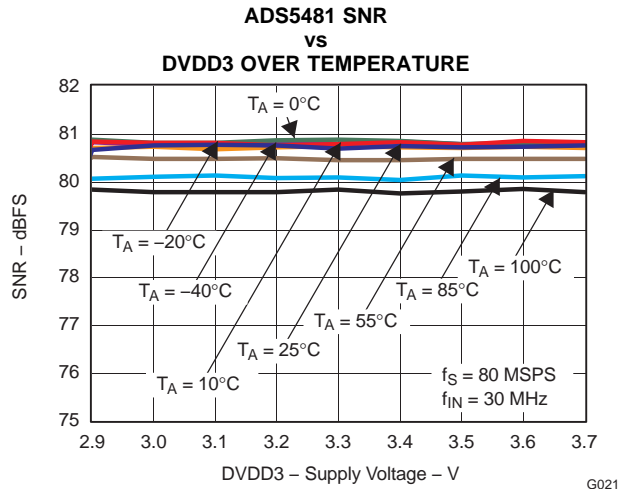

Figure 17.

TYPICAL CHARACTERISTICS (continued)

At $T_A = +25^\circ\text{C}$, sampling rate = max rated, 50% clock duty cycle, 3- V_{PP} differential sinusoidal clock, analog input amplitude = -1 dBFS, AVDD5 = 5 V, AVDD3 = 3.3 V, and DVDD3 = 3.3 V, unless otherwise noted.



TYPICAL CHARACTERISTICS (continued)

At $T_A = +25^\circ\text{C}$, sampling rate = max rated, 50% clock duty cycle, $3-V_{PP}$ differential sinusoidal clock, analog input amplitude = -1 dBFS, $AVDD5 = 5$ V, $AVDD3 = 3.3$ V, and $DVDD3 = 3.3$ V, unless otherwise noted.

ADS5482 - 105 MSPS Typical Data

Plots in this section are with a clock of 105MSPS unless otherwise specified.

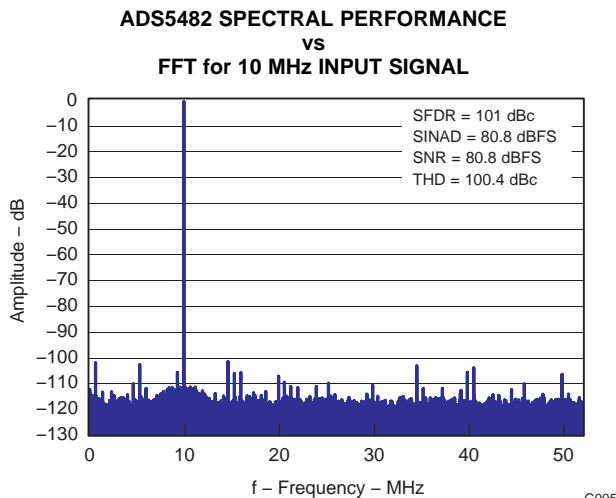

Figure 19.

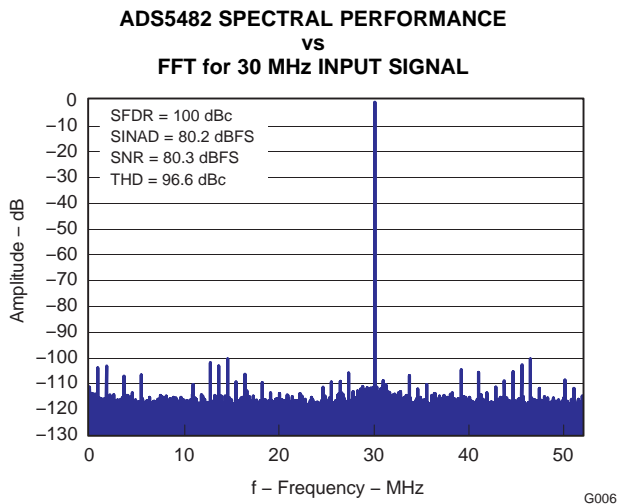

Figure 20.

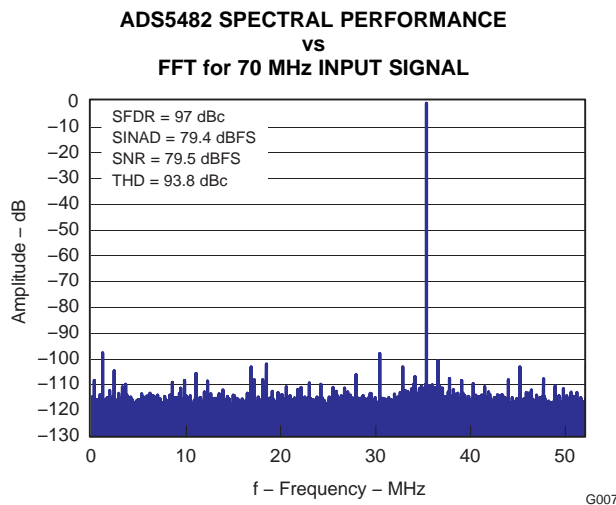

Figure 21.

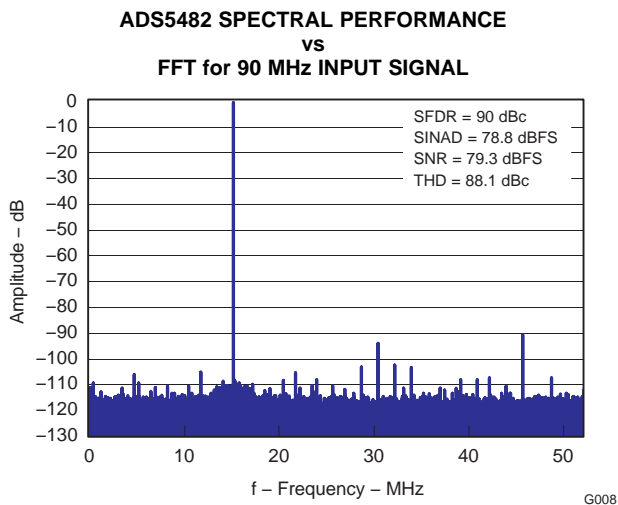

Figure 22.

TYPICAL CHARACTERISTICS (continued)

At $T_A = +25^\circ\text{C}$, sampling rate = max rated, 50% clock duty cycle, 3- V_{PP} differential sinusoidal clock, analog input amplitude = -1 dBFS, AVDD5 = 5 V, AVDD3 = 3.3 V, and DVDD3 = 3.3 V, unless otherwise noted.

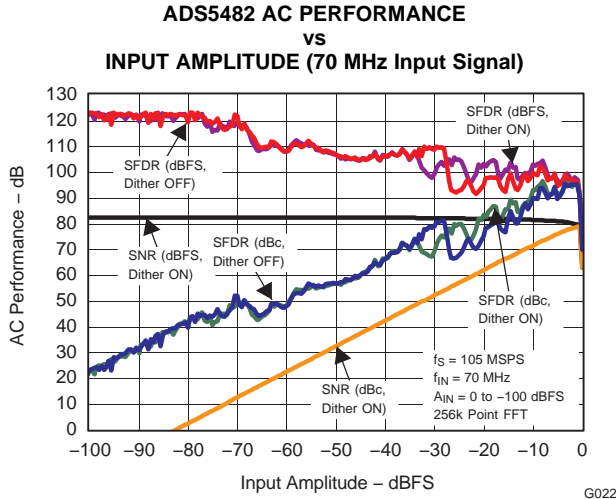

Figure 23.

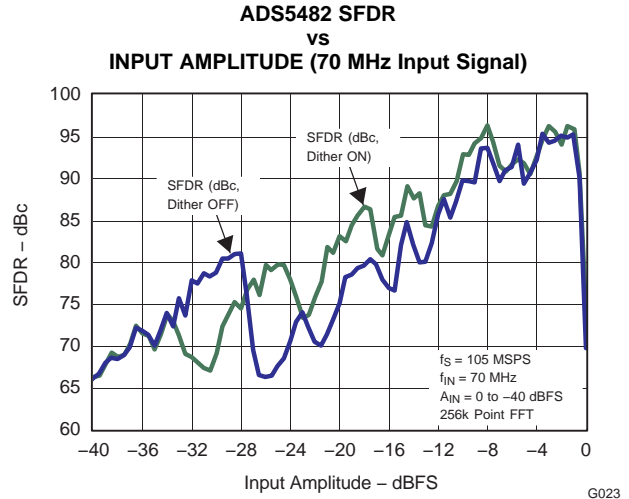

Figure 24.

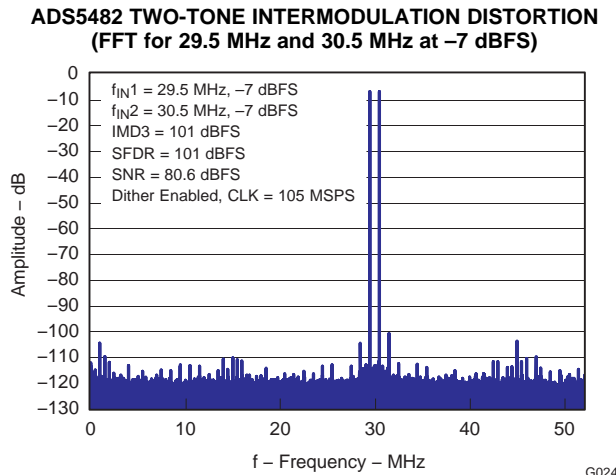

Figure 25.

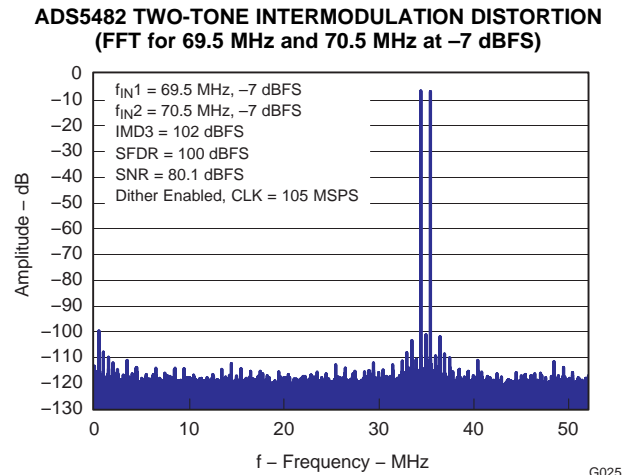

Figure 26.

TYPICAL CHARACTERISTICS (continued)

At $T_A = +25^\circ\text{C}$, sampling rate = max rated, 50% clock duty cycle, 3- V_{PP} differential sinusoidal clock, analog input amplitude = -1 dBFS, AVDD5 = 5 V, AVDD3 = 3.3 V, and DVDD3 = 3.3 V, unless otherwise noted.

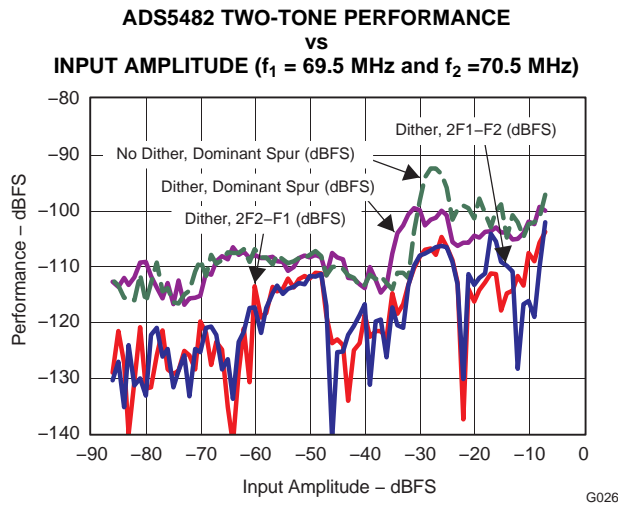

Figure 27.

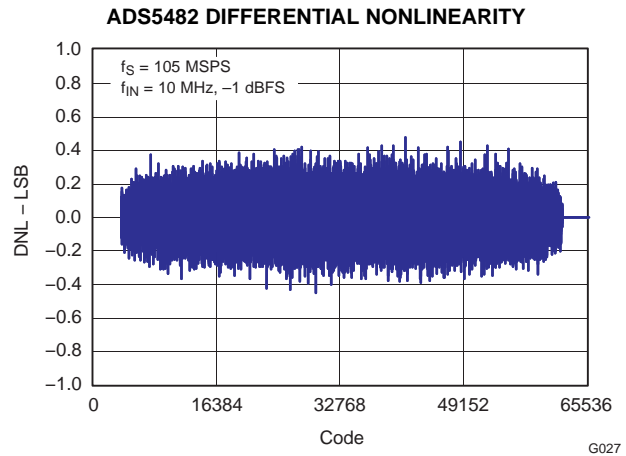

Figure 28.

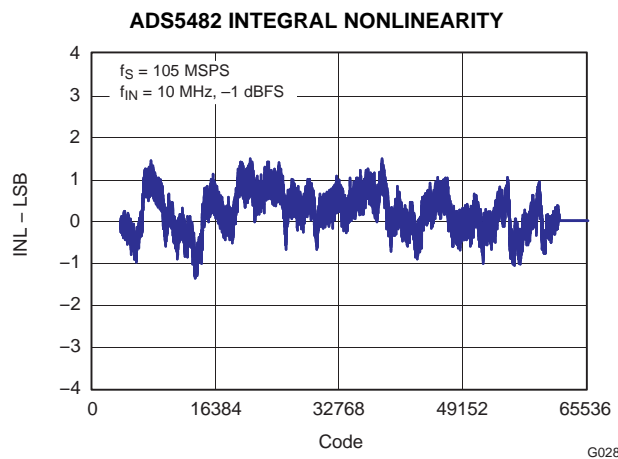

Figure 29.

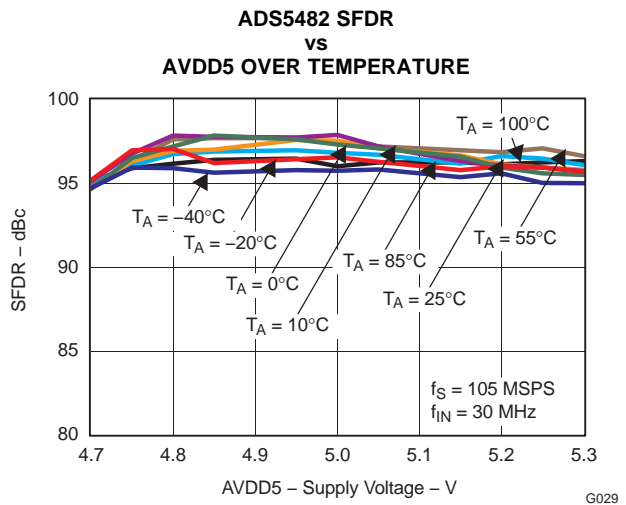

Figure 30.

TYPICAL CHARACTERISTICS (continued)

At $T_A = +25^\circ\text{C}$, sampling rate = max rated, 50% clock duty cycle, 3- V_{PP} differential sinusoidal clock, analog input amplitude = -1 dBFS, AVDD5 = 5 V, AVDD3 = 3.3 V, and DVDD3 = 3.3 V, unless otherwise noted.

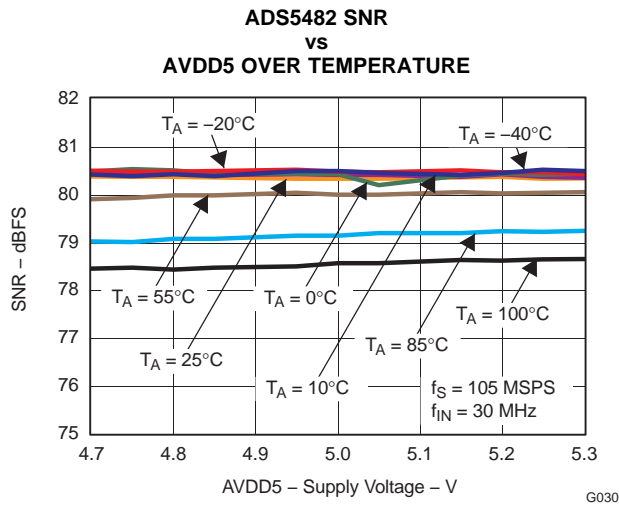

Figure 31.

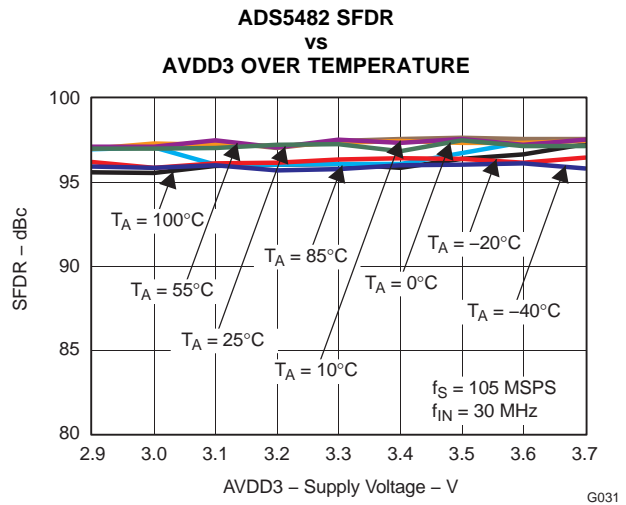

Figure 32.

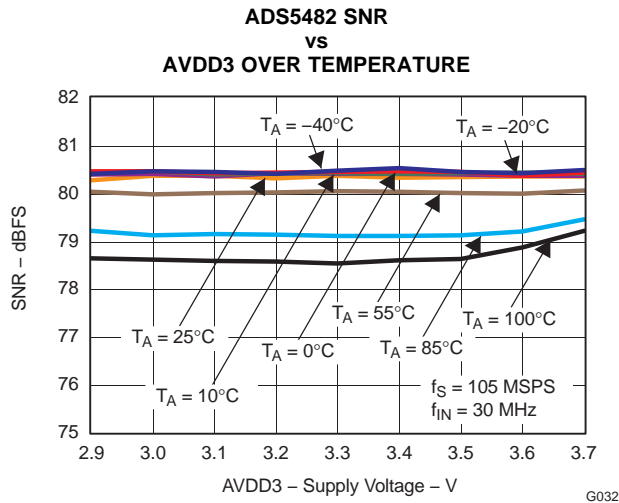

Figure 33.

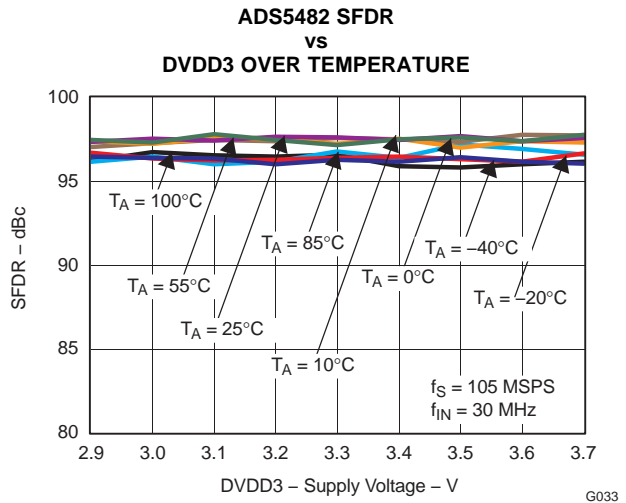

Figure 34.

TYPICAL CHARACTERISTICS (continued)

At $T_A = +25^\circ\text{C}$, sampling rate = max rated, 50% clock duty cycle, 3- V_{PP} differential sinusoidal clock, analog input amplitude = -1 dBFS, AVDD5 = 5 V, AVDD3 = 3.3 V, and DVDD3 = 3.3 V, unless otherwise noted.

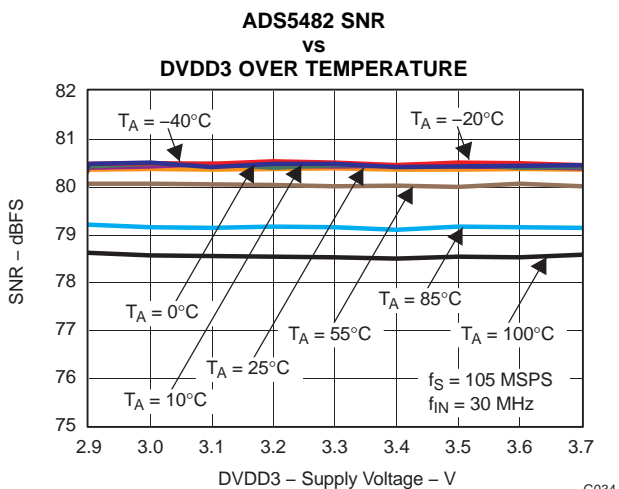

Figure 35.

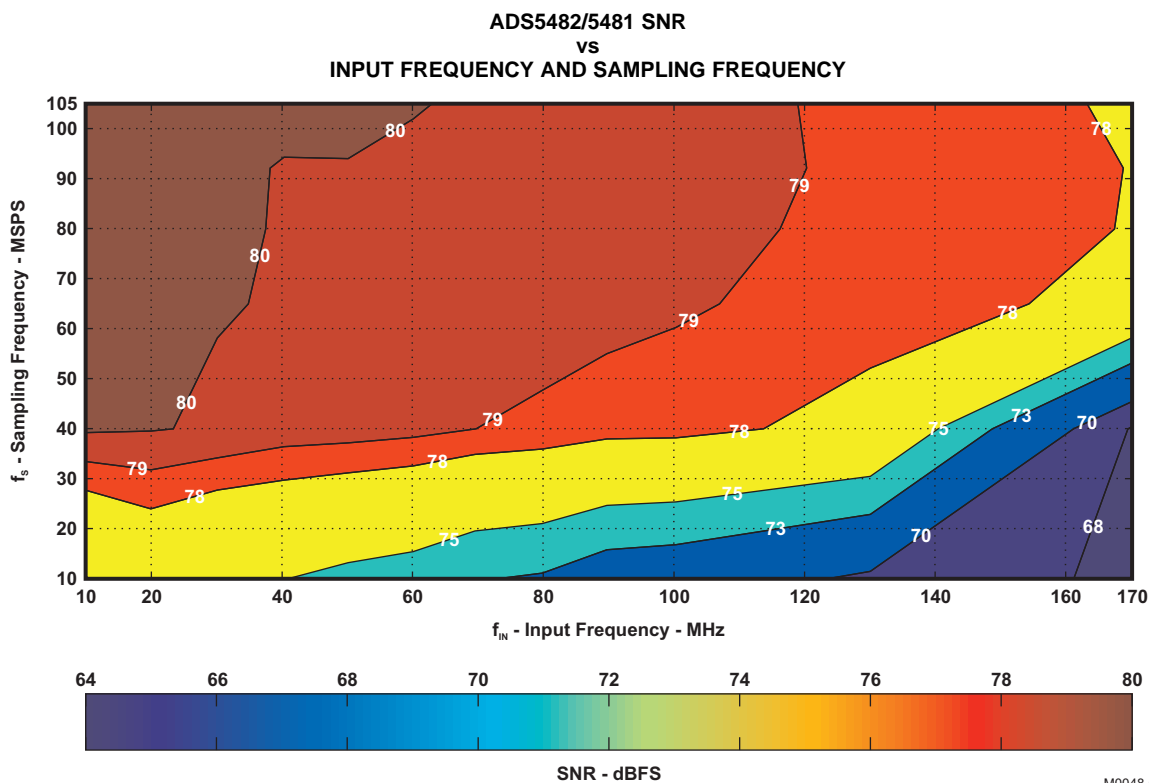
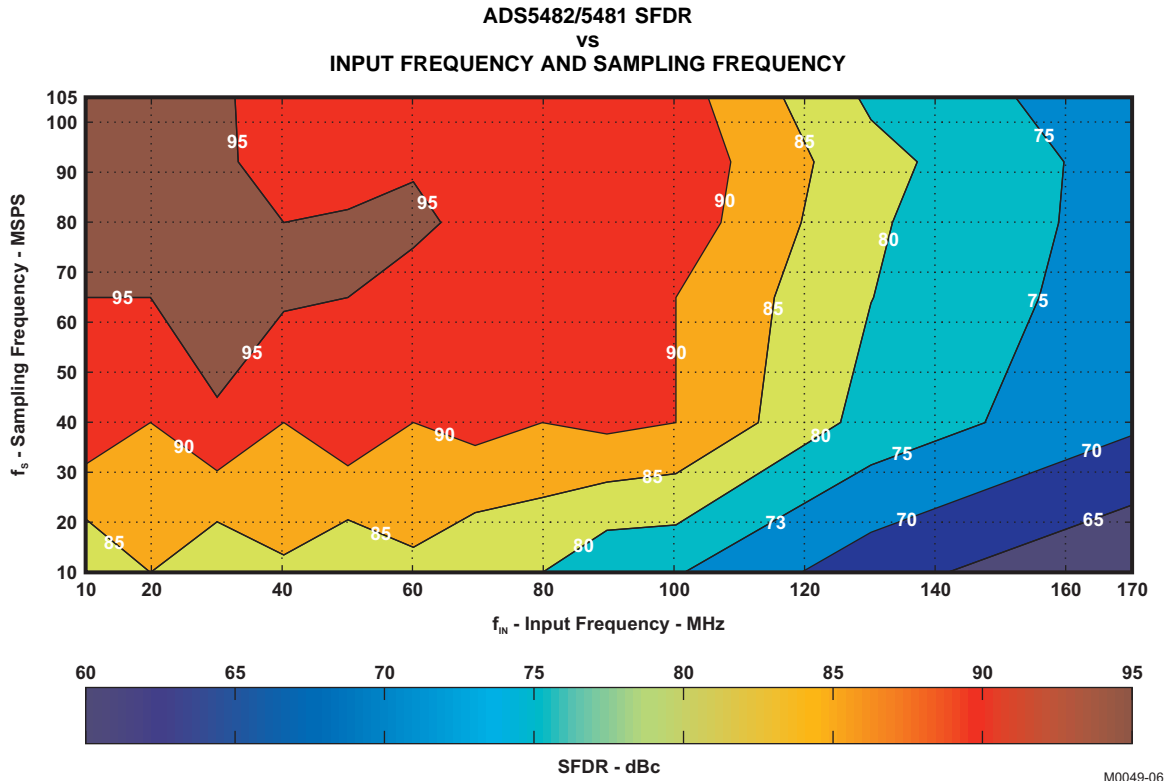

Figure 36.

TYPICAL CHARACTERISTICS (continued)

At $T_A = +25^\circ\text{C}$, sampling rate = max rated, 50% clock duty cycle, 3- V_{PP} differential sinusoidal clock, analog input amplitude = -1 dBFS, AVDD5 = 5 V, AVDD3 = 3.3 V, and DVDD3 = 3.3 V, unless otherwise noted.



M0049-06

TYPICAL CHARACTERISTICS (continued)

At $T_A = +25^\circ\text{C}$, sampling rate = max rated, 50% clock duty cycle, 3- V_{PP} differential sinusoidal clock, analog input amplitude = -1 dBFS, AVDD5 = 5 V, AVDD3 = 3.3 V, and DVDD3 = 3.3 V, unless otherwise noted.

ADS5483 - 135 MSPS Typical Data

Plots in this section are with a clock of 135MSPS unless otherwise specified.

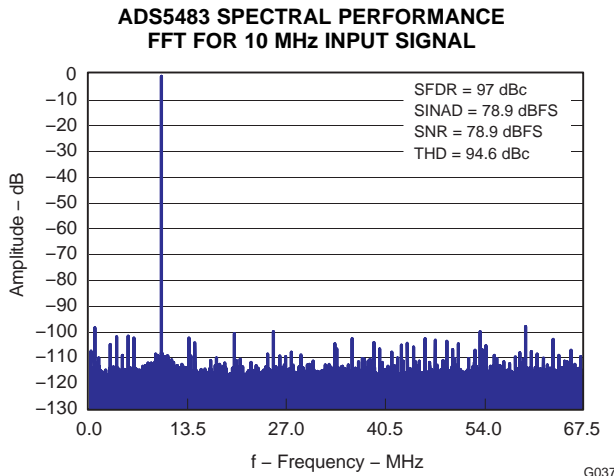

Figure 38.

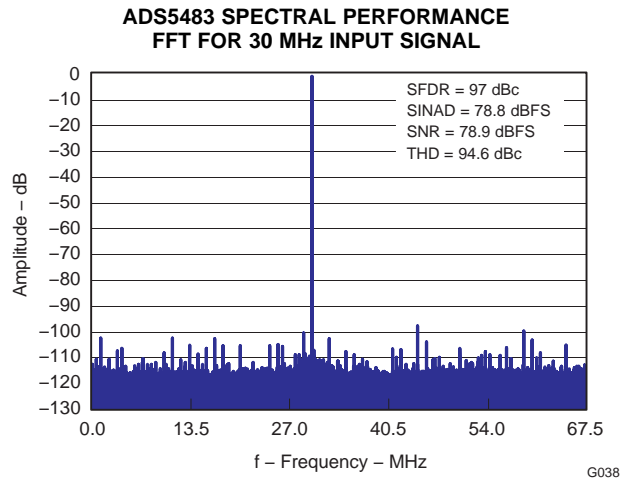

Figure 39.

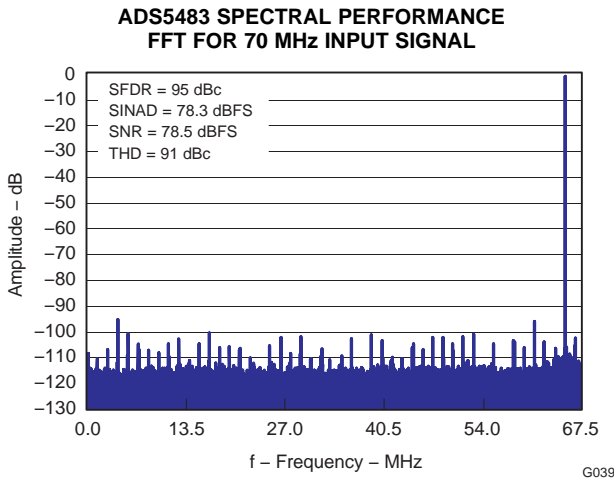

Figure 40.

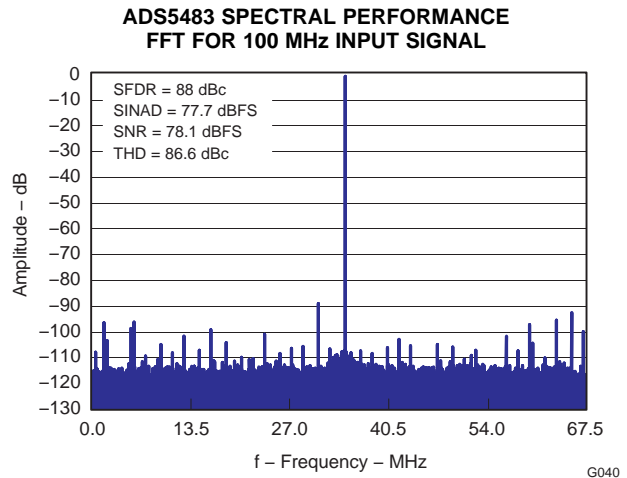

Figure 41.

TYPICAL CHARACTERISTICS (continued)

At $T_A = +25^\circ\text{C}$, sampling rate = max rated, 50% clock duty cycle, 3- V_{PP} differential sinusoidal clock, analog input amplitude = -1 dBFS, AVDD5 = 5 V, AVDD3 = 3.3 V, and DVDD3 = 3.3 V, unless otherwise noted.

ADS5483 TWO-TONE INTERMODULATION DISTORTION (FFT for 39.5 MHz and 40.5 MHz at -10 dBFS)

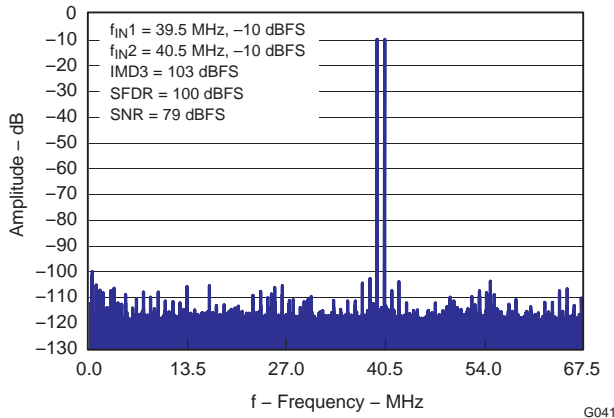

Figure 42.

NORMALIZED GAIN RESPONSE VS INPUT FREQUENCY

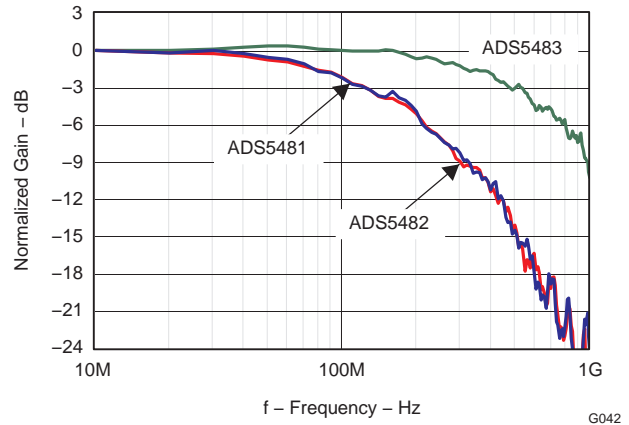

Figure 43.

ADS5483 DIFFERENTIAL NONLINEARITY

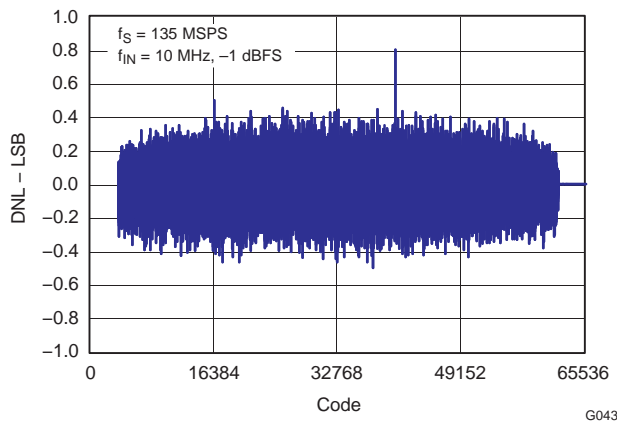

Figure 44.

ADS5483 INTEGRAL NONLINEARITY

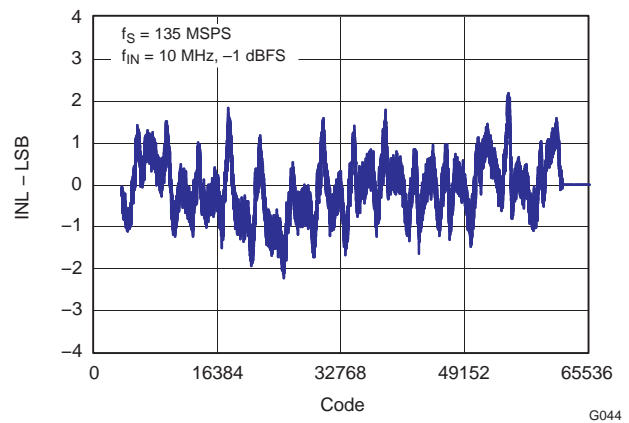

Figure 45.

TYPICAL CHARACTERISTICS (continued)

At $T_A = +25^\circ\text{C}$, sampling rate = max rated, 50% clock duty cycle, 3-V_{PP} differential sinusoidal clock, analog input amplitude = -1 dBFS , $\text{AVDD5} = 5\text{ V}$, $\text{AVDD3} = 3.3\text{ V}$, and $\text{DVDD3} = 3.3\text{ V}$, unless otherwise noted.

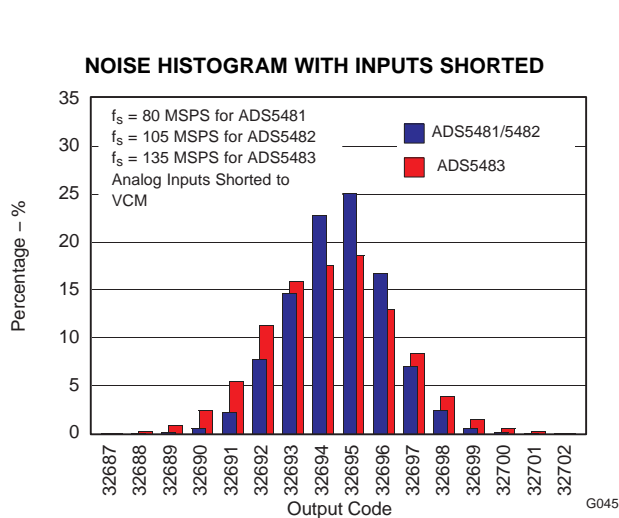

Figure 46.

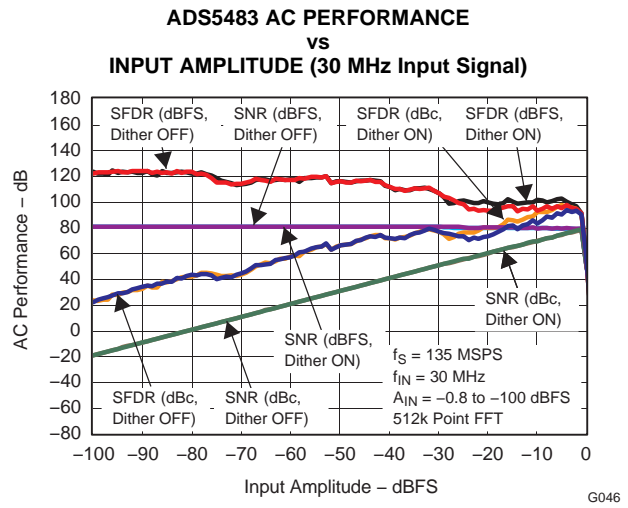

Figure 47.

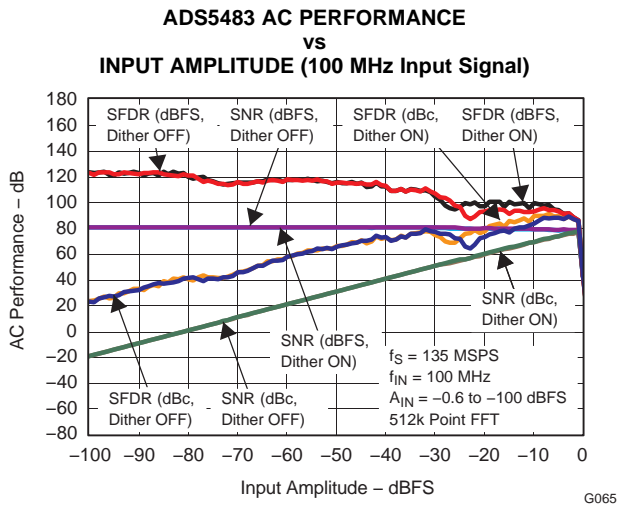

Figure 48.

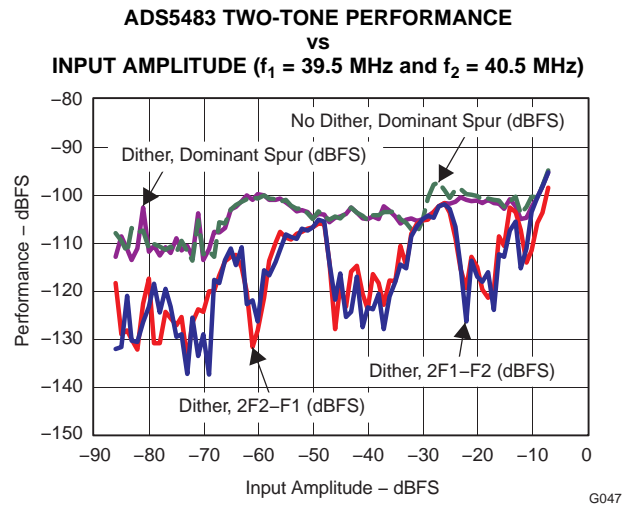

Figure 49.

TYPICAL CHARACTERISTICS (continued)

At $T_A = +25^\circ\text{C}$, sampling rate = max rated, 50% clock duty cycle, 3- V_{PP} differential sinusoidal clock, analog input amplitude = -1 dBFS, AVDD5 = 5 V, AVDD3 = 3.3 V, and DVDD3 = 3.3 V, unless otherwise noted.

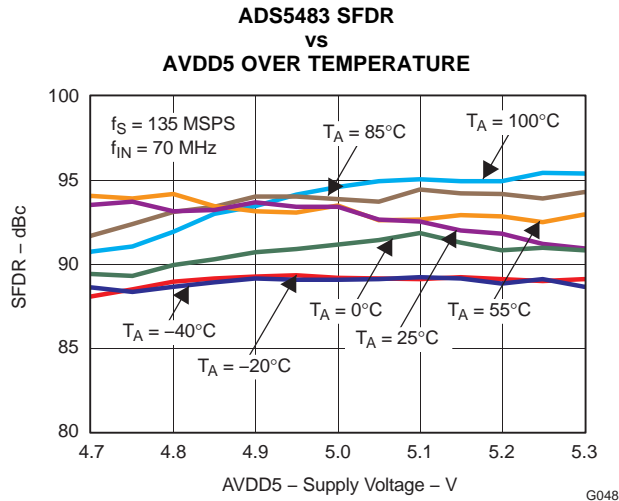

Figure 50.

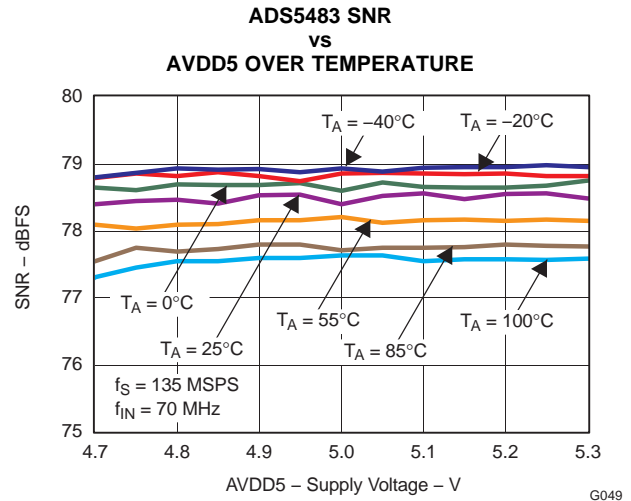

Figure 51.

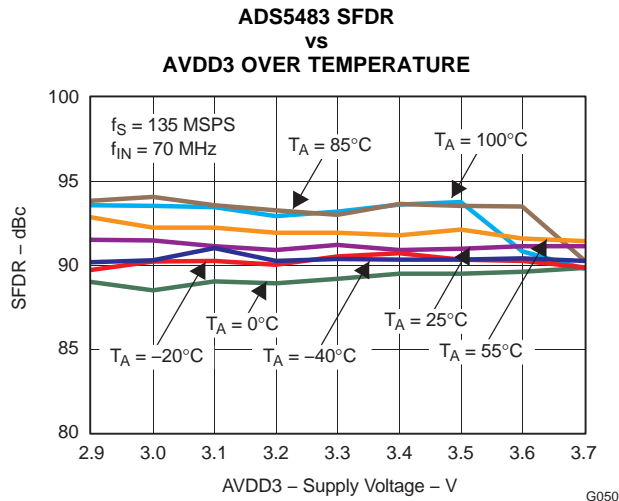

Figure 52.

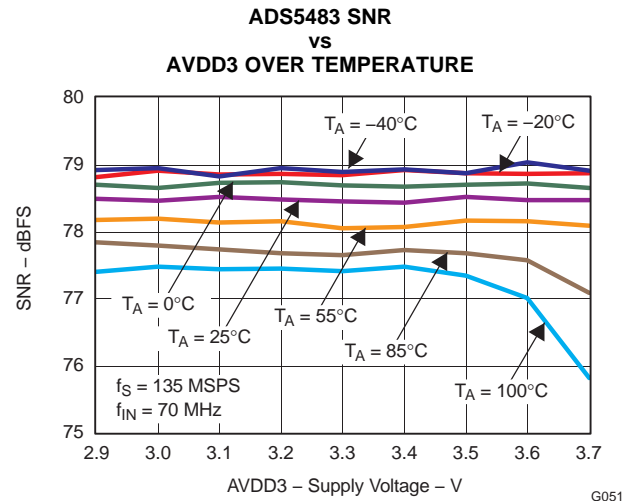

Figure 53.

TYPICAL CHARACTERISTICS (continued)

At $T_A = +25^\circ\text{C}$, sampling rate = max rated, 50% clock duty cycle, 3- V_{PP} differential sinusoidal clock, analog input amplitude = -1 dBFS, AVDD5 = 5 V, AVDD3 = 3.3 V, and DVDD3 = 3.3 V, unless otherwise noted.

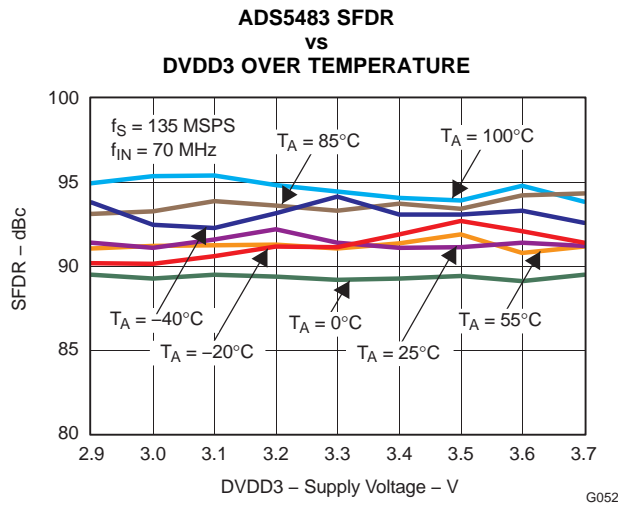

Figure 54.

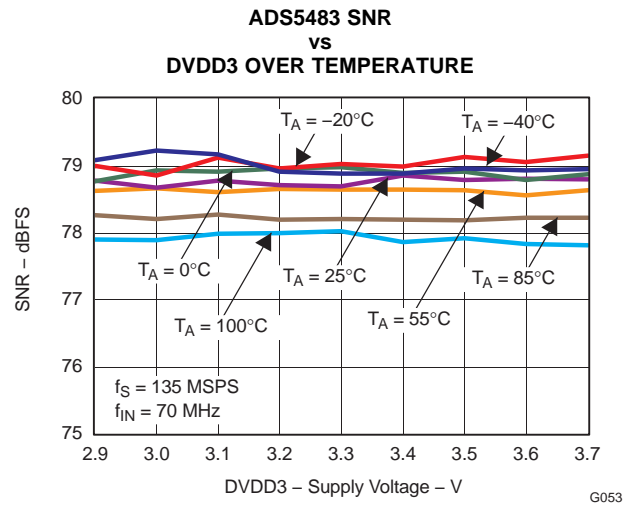

Figure 55.

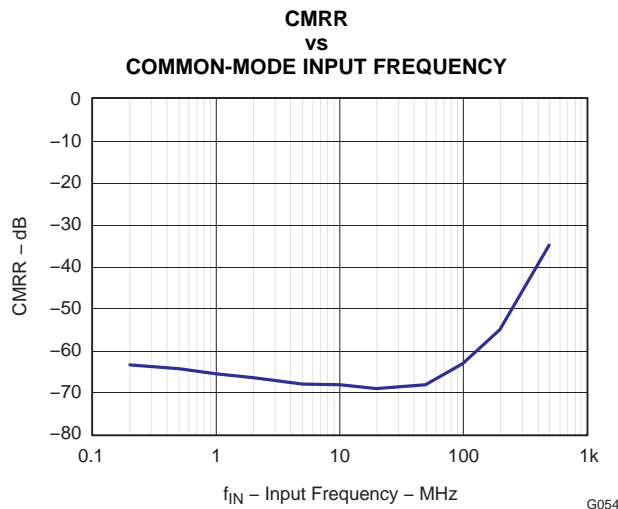

Figure 56.

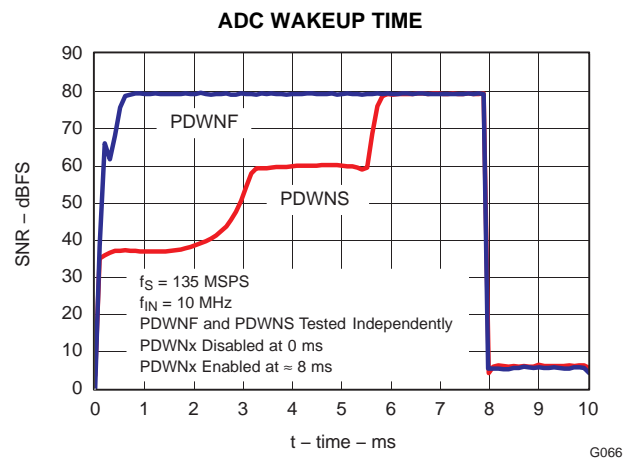

Figure 57.

TYPICAL CHARACTERISTICS (continued)

At $T_A = +25^\circ\text{C}$, sampling rate = max rated, 50% clock duty cycle, $3\text{-}V_{PP}$ differential sinusoidal clock, analog input amplitude = -1 dBFS , $AVDD5 = 5\text{ V}$, $AVDD3 = 3.3\text{ V}$, and $DVDD3 = 3.3\text{ V}$, unless otherwise noted.

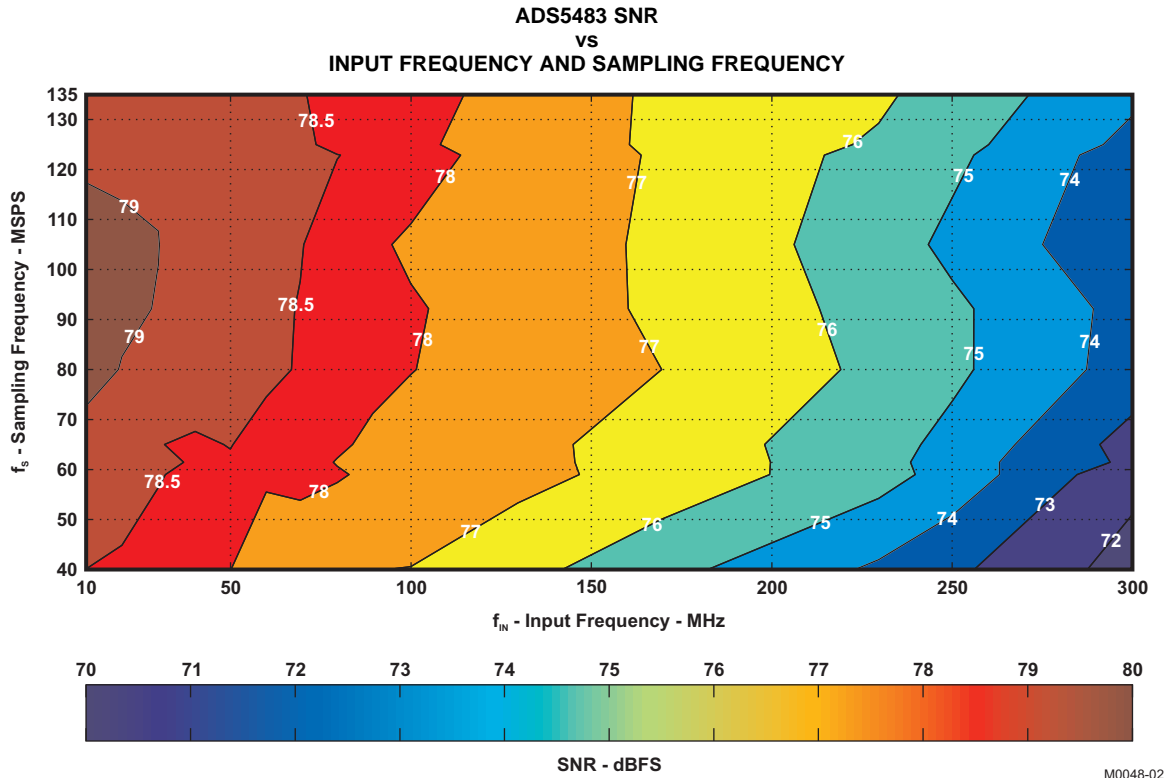
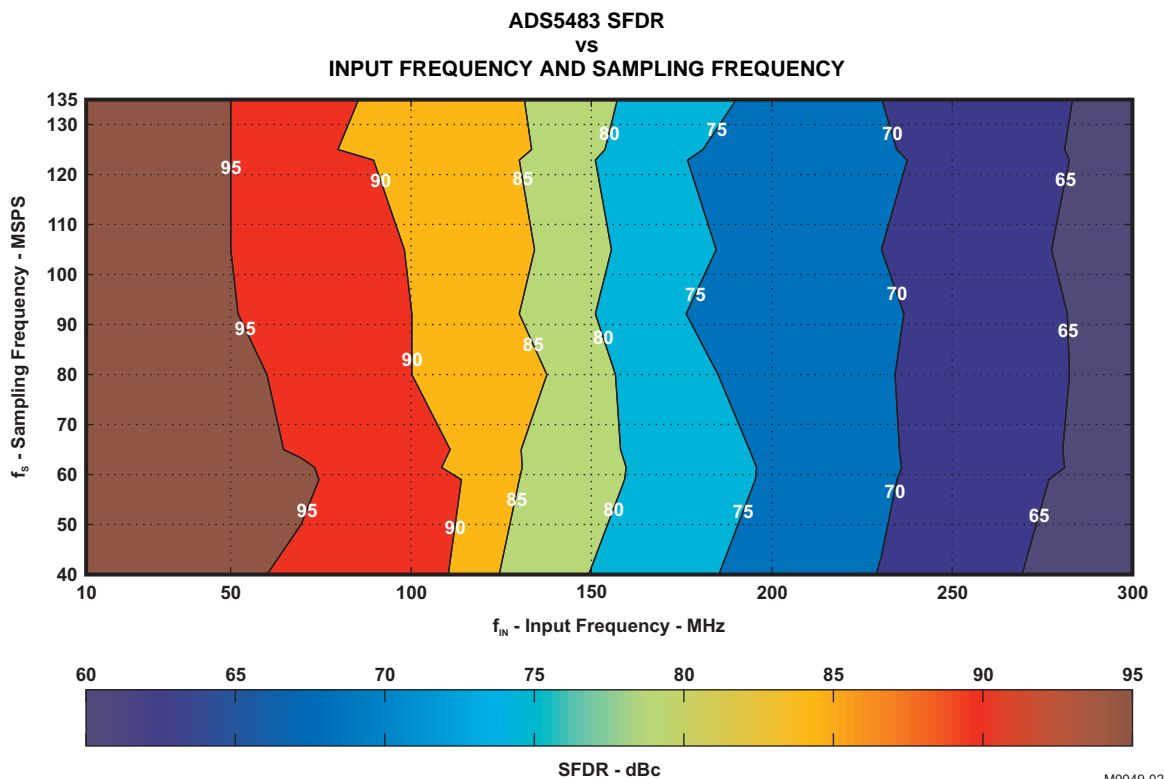

Figure 58.

TYPICAL CHARACTERISTICS (continued)

At $T_A = +25^\circ\text{C}$, sampling rate = max rated, 50% clock duty cycle, 3- V_{PP} differential sinusoidal clock, analog input amplitude = -1 dBFS, AVDD5 = 5 V, AVDD3 = 3.3 V, and DVDD3 = 3.3 V, unless otherwise noted.



M0049-02

Figure 59.

APPLICATIONS INFORMATION

Theory of Operation

The ADS5481/ADS5482/ADS5483 (ADS548x) is a 16-bit, 80-135MSPS family of monolithic pipeline ADCs. The bipolar analog core operates from 5-V and 3.3-V supplies, while the output uses a 3.3-V supply to provide LVDS-compatible outputs. Prior to the track-and-hold, the analog input signal passes through a high-performance bipolar buffer. The buffer presents a high and consistent impedance to the analog inputs. The buffer isolates the board circuitry external to the ADC from the sampling glitches caused by the track-and-hold in the ADC. The conversion process is initiated by the falling edge of the external input clock. At that instant, the differential input signal is captured by the input track-and-hold, and the input sample is converted sequentially by a series of lower resolution stages, with the outputs combined in a digital correction logic block. Both the rising and the falling clock edges are used to propagate the sample through the pipeline every half clock cycle. This process results in a data latency of 4.5 clock cycles, after which the output data are available as a 16-bit parallel word, coded in offset binary format.

Input Configuration

The analog input for the ADS548x consists of an analog pseudo-differential buffer followed by a bipolar transistor T&H. The analog buffer isolates the source driving the input of the ADC from any internal switching and presents a high impedance that is easy to drive at high input frequencies, compared to an ADC without a buffered input. The input common-mode is set internally through a 1000- Ω resistor connected from 3.1 V to each of the inputs. This configuration results in a differential input impedance of 2 k Ω at 0 Hz.

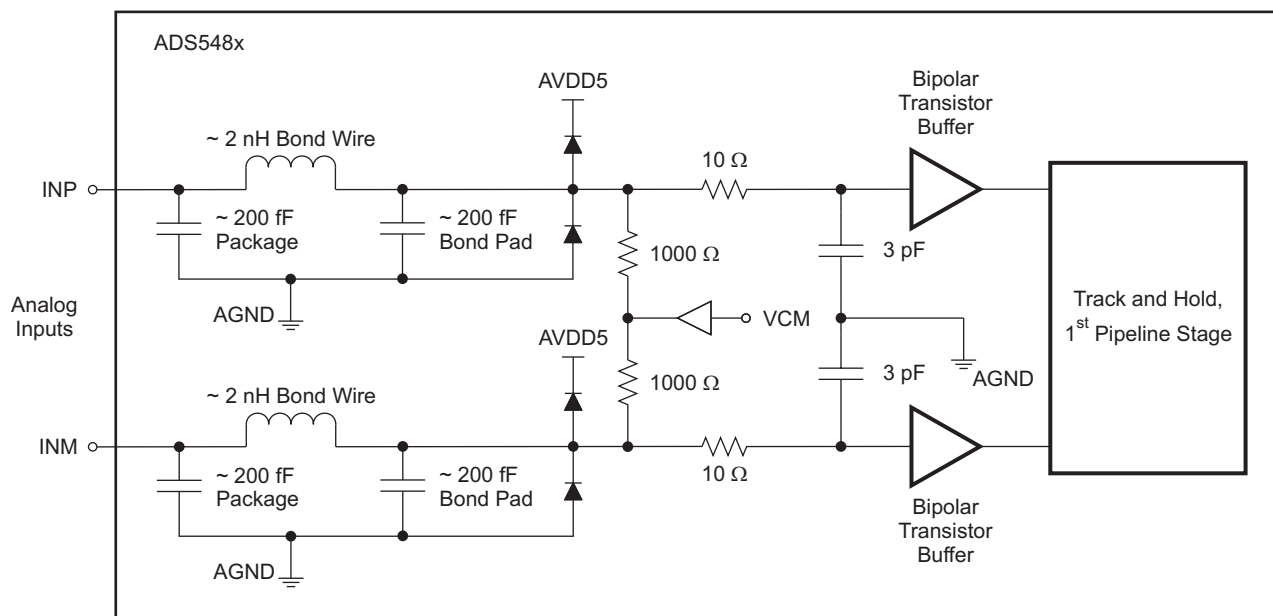

S0293-02

Figure 60. Analog Input Circuit

For a full-scale differential input, each of the differential lines of the input signal (pins 11 and 12) swings symmetrically between $(3.1 \text{ V} + 0.75 \text{ V})$ and $(3.1 \text{ V} - 0.75 \text{ V})$. This range means that each input has a maximum signal swing of 1.5 V_{PP} for a total differential input signal swing of 3 V_{PP} . Operation below 3 V_{PP} is allowable, with the characteristics of performance versus input amplitude demonstrated in Figure 6 through Figure 10. For instance, for performance at 2 V_{PP} rather than 3 V_{PP} , refer to the SNR and SFDR at -3.5 dBFS ($0 \text{ dBFS} = 3 \text{ V}_{PP}$). The maximum swing is determined by the internal reference voltage generator, eliminating the need for any external circuitry for this purpose. The primary degradation visible if the max amplitude is kept to 2 V_{PP} is $\sim 3 \text{ dBc}$ of SNR compared to using 3 V_{PP} , while SFDR will be the same or even improved. The smaller input signal will also likely help any components in the signal chain prior to the ADC to be more linear and provide better distortion.

The ADS548x performs optimally when the analog inputs are driven differentially. The circuit in [Figure 61](#) shows one possible configuration using an RF transformer with termination either on the primary or on the secondary of the transformer. If voltage gain is required, a step-up transformer can be used.

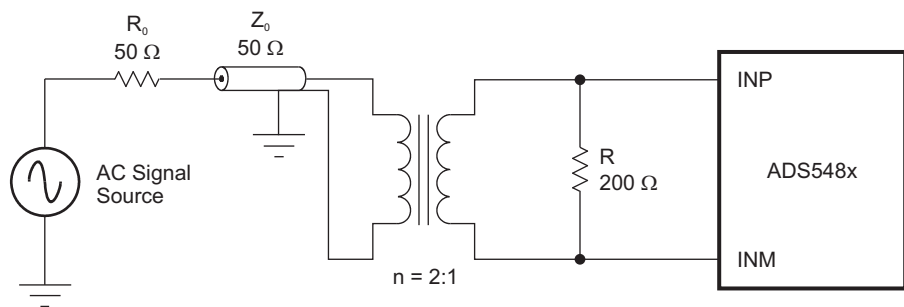

S0176-04

Figure 61. Converting a Single-Ended Input to a Differential Signal Using an RF Transformer

Dither

The ADS548x family of devices contain a dither option that is enabled via the DITHEREN pin. Dither is a technique applied to convert small static errors in the converter to dynamic errors, which will look similar to white noise in the output. In virtually all cases tested, the harmonic performance is equal or better when dither is enabled versus disabled. It improves the harmonics that are a function of the static errors. The dither is very low level and will only be indicated in the output waveform as wideband noise that may slightly degrade the SNR (<0.5dB). It is recommended that it be enabled, but users should allow the capability to disable it in the event they suspect it may be degrading their specific application, or to compare the results during their evaluation. [Figure 6](#) through [Figure 10](#) show the minor differences of dither ON/OFF when carefully studied.

External Voltage Reference

For systems that require the analog signal gain to be adjusted or calibrated, this can be performed by using an external reference. The dependency on the signal amplitude to the value of the external reference voltage is characterized typically by [Figure 62](#) ($V_{REF} = 1.2\text{ V}$ is normalized to 0 dB as this is the internal reference voltage). As can be seen in the linear fit, this equates to approximately ~1 dB of signal adjustment per 100 mV of reference adjustment. The range of allowable variation depends on the analog input amplitude that is applied to the inputs and the desired spectral performance, as can be seen in the performance versus external reference graphs in [Figure 63](#) and [Figure 64](#).

For dc-coupled applications that use the VCM pin of the ADS548x as the common mode of the signal in the analog signal gain path prior to the ADC inputs, [Figure 66](#) indicates very little change in VCM output as V_{REF} is externally adjusted. The VCM output is buffered with a 2k Ω series output resistor.

The method for disabling the internal reference for use with an external reference is described in [Table 5](#).

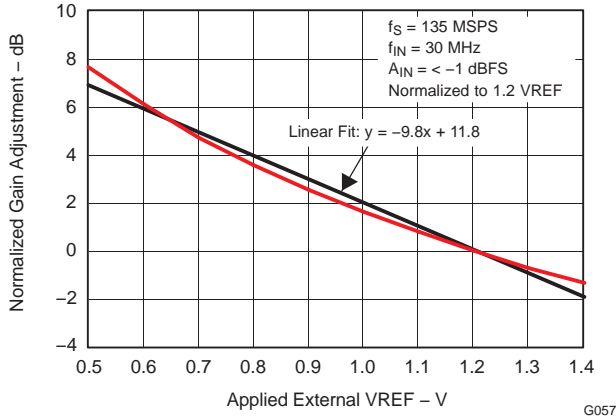

Figure 62. Signal Gain Adjustment versus External Reference (VREF)

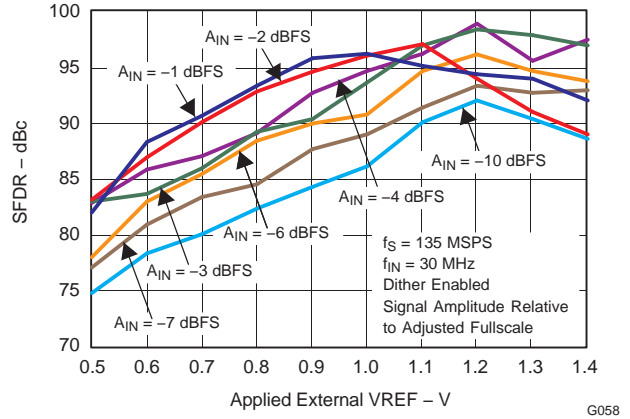

Figure 63. SFDR versus External VREF and A_{IN}

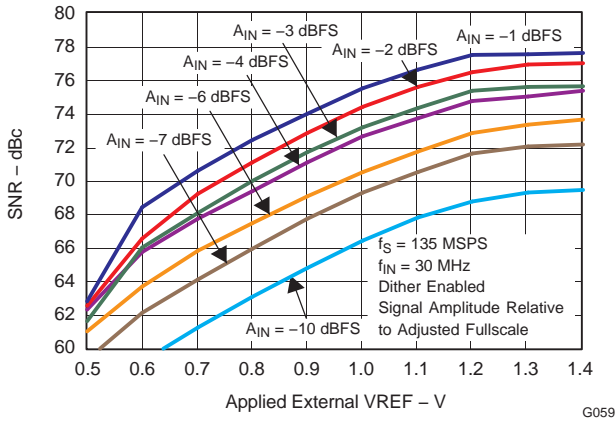

Figure 64. SNR versus External VREF and A_{IN}

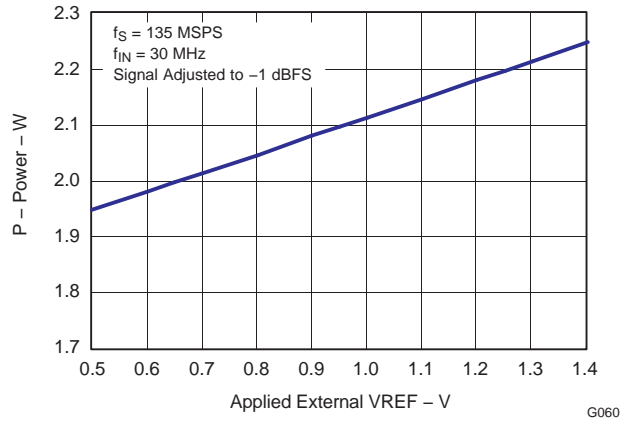

Figure 65. Total Power Consumption versus External VREF

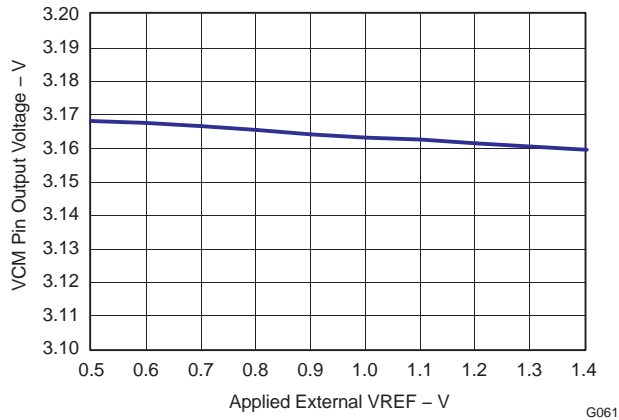
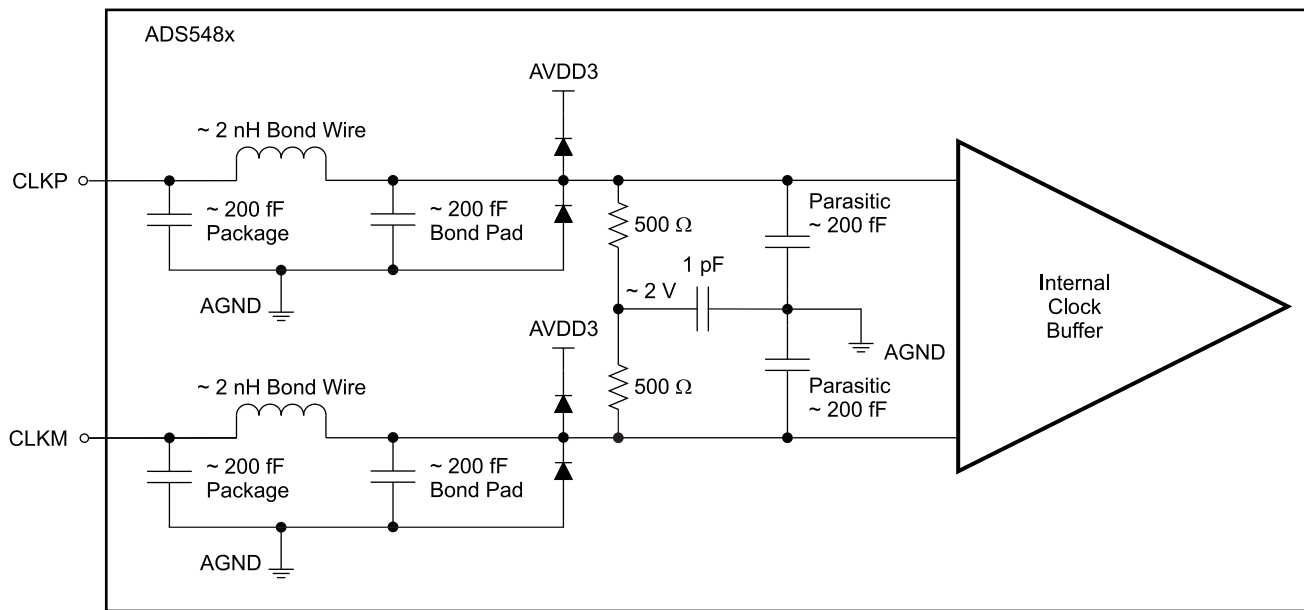

Figure 66. VCM Pin Output versus External VREF

Clock Inputs

The ADS548x equivalent clock input circuit is shown in Figure 67. The clock inputs can be driven with either a differential clock signal or a single-ended clock input, but differential is highly recommended. The characterization of the ADS548x is typically performed with a $3\text{-}V_{PP}$ differential clock, but the ADC performs well with a differential clock amplitude down to $\sim 1\text{-}V_{PP}$, as shown in Figure 69 and Figure 70. The clock amplitude becomes more of a factor in performance as the analog input frequency increases. When single-ended clocking is a necessity, it is best to connect CLKM to ground with a $0.01\text{-}\mu\text{F}$ capacitor, while CLKP is ac-coupled with a $0.01\text{-}\mu\text{F}$ capacitor to the clock source, as shown in Figure 68.



S0292-02

Figure 67. Clock Input Circuit

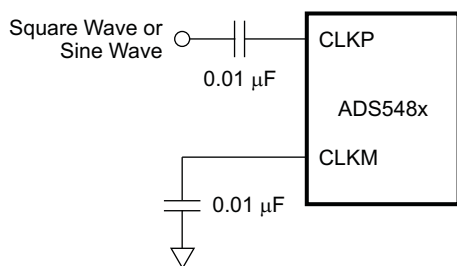

S0168-08

Figure 68. Single-Ended Clock

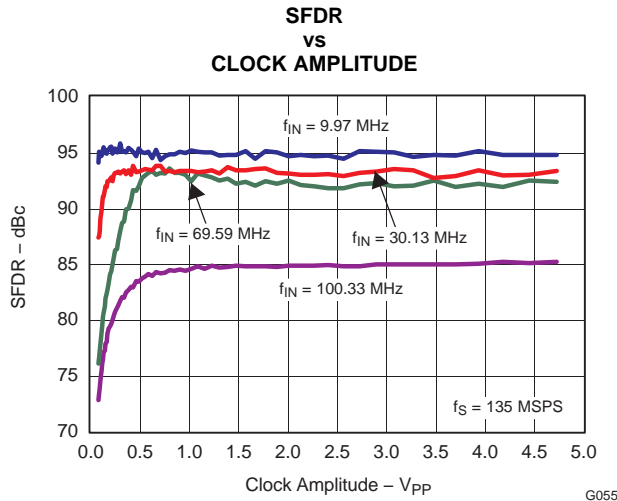

Figure 69.

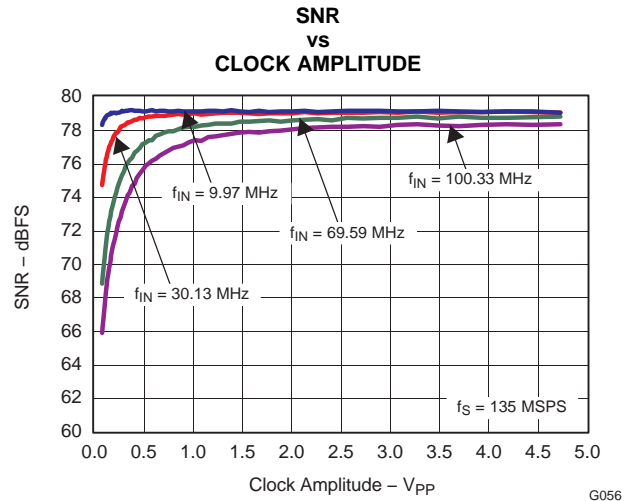

Figure 70.

For jitter-sensitive applications, the use of a differential clock has some advantages at the system level. The differential clock allows for common-mode noise rejection at the printed circuit board (PCB) level. With a differential clock, the signal-to-noise ratio of the ADC is better for jitter-sensitive, high-frequency applications because the board level clock jitter is superior.

The sampling process will be more sensitive to jitter using high analog input frequencies or slow clock frequencies. Large clock amplitude levels are recommended when possible to reduce the indecision (jitter) in the ADC clock input buffer. Whenever possible, the ideal combination is a differential clock with large signal swing (~1-3Vpp). Figure 71 demonstrates a recommended method for converting a single-ended clock source into a differential clock; it is similar to the configuration found on the evaluation board and was used for much of the characterization. See also *Clocking High Speed Data Converters (SLYT075)* for more details.

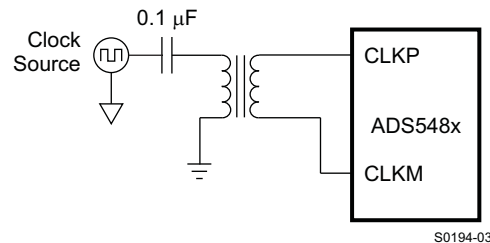

Figure 71. Differential Clock

The common-mode voltage of the clock inputs is set internally to ~2 V using internal 0.5-kΩ resistors. It is recommended to use ac coupling, but if this scheme is not possible, the ADS548x features good tolerance to clock common-mode variation (as shown in Figure 72 and Figure 73). The internal ADC core uses both edges of the clock for the conversion process. Ideally, a 50% duty-cycle clock signal should be provided. Performance degradation as a result of duty cycle can be seen in Figure 74.

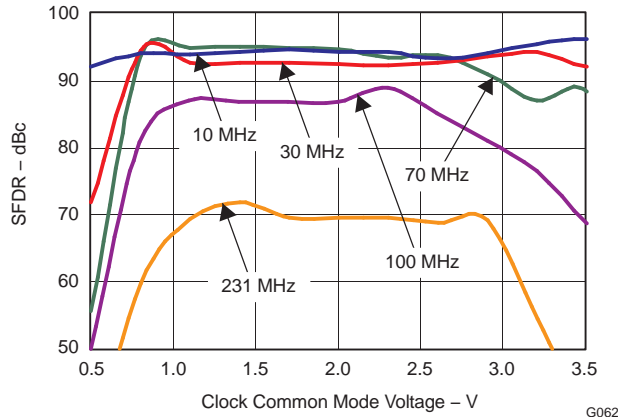

Figure 72. SFDR versus Clock Common Mode

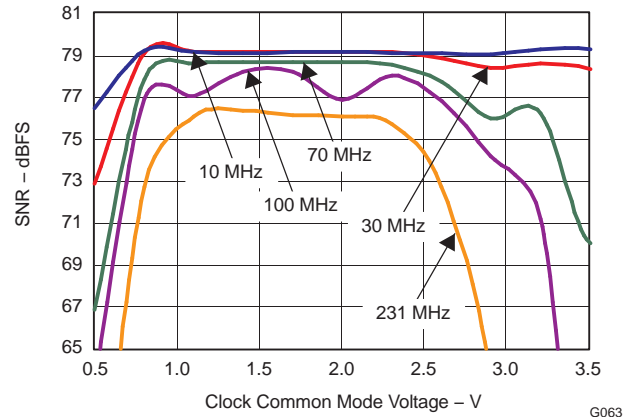

Figure 73. SNR versus Clock Common Mode

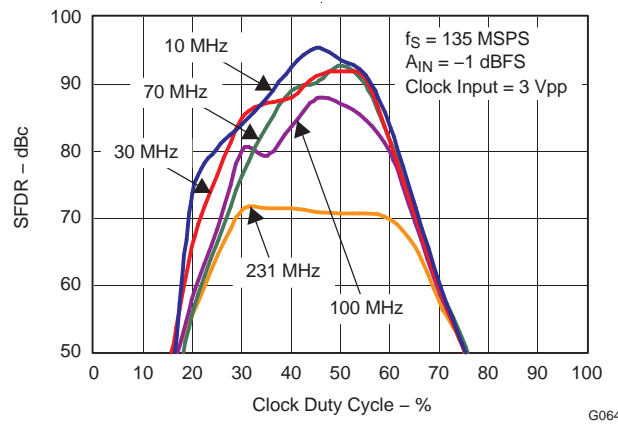

Figure 74. SFDR vs Clock Duty Cycle

The ADS5483 is capable of achieving 78.2 dBFS SNR at 100 MHz of analog input frequency. In order to achieve the SNR at 100 MHz the clock source rms jitter (at the ADC clock input pins) must be at most 205 fsec in order for the total rms jitter to be 220 fsec due to internal ADC aperture jitter of ~80 fsec. A summary of maximum recommended rms clock jitter as a function of analog input frequency for the ADS5483 is provided in Table 3. The equations used to create the table are presented and can be used to estimate required clock jitter for virtually any pipeline ADC.

Table 3. Recommended Approximate RMS Clock Jitter for ADS5483

ANALOG INPUT FREQUENCY (MHz)	MEASURED SNR (dBc)	TOTAL JITTER (fsec rms)	MAXIMUM CLOCK JITTER (fsec rms)
1	78.2	19581	19581
10	78	2004	2002
70	77.8	300	289
100	77.2	220	205
130	76	177	158
170	75.8	152	129
230	75.1	122	92
300	73.2	116	84

Equation 1 and Equation 2 are used to estimate the required clock source jitter.

$$\text{SNR (dBc)} = -20 \times \text{LOG}_{10} (2 \times \pi \times f_{\text{IN}} \times j_{\text{TOTAL}}) \quad (1)$$

$$j_{\text{TOTAL}} = (j_{\text{ADC}}^2 + j_{\text{CLOCK}}^2)^{1/2} \quad (2)$$

where:

- j_{TOTAL} = the rms summation of the clock and ADC aperture jitter;
- j_{ADC} = the ADC internal aperture jitter which is located in the data sheet;
- j_{CLOCK} = the rms jitter of the clock at the clock input pins to the ADC; and
- f_{IN} = the analog input frequency.

Notice that the SNR is a strong function of the analog input frequency, not the clock frequency. The slope of the clock source edges can have a mild impact on SNR as well and is not taken into account for these estimates. For this reason, maximizing clock source amplitudes at the ADC clock inputs is recommended, though not required (faster slope is desirable for jitter-related SNR). For more information on clocking high-speed ADCs, see Application Note [SLWA034](#), *Implementing a CDC7005 Low Jitter Clock Solution For High-Speed, High-IF ADC Devices*, on the Texas Instruments web site. Recommended clock distribution chips (CDCs) are the TI [CDCE72010](#) and [CDCM7005](#). Depending on the jitter requirements, a band pass filter (BPF) is sometimes required between the CDC and the ADC. If the insertion loss of the BPF causes the clock amplitude to be too low for the ADC, or the clock source amplitude is too low to begin with, an inexpensive amplifier can be placed between the CDC and the BPF, as its harmonics and wide-band noise will be reduced by the BPF.

Figure 75 represents a scenario where an LVCMOS single-ended clock output is used from a TI CDCE72010 with the clock signal path optimized for maximum amplitude and minimum jitter. The jitter of this setup is difficult to estimate and requires a careful phase noise analysis of the clock path. The BPF (and possibly a low-cost amplifier because of insertion loss in the BPF) can improve the jitter between the CDC and ADC when the jitter provided by the CDC is still not adequate. The total jitter at the CDCE72010 output depends largely on the phase noise of the VCXO/VCO selected, as well as from the CDCE72010 itself.

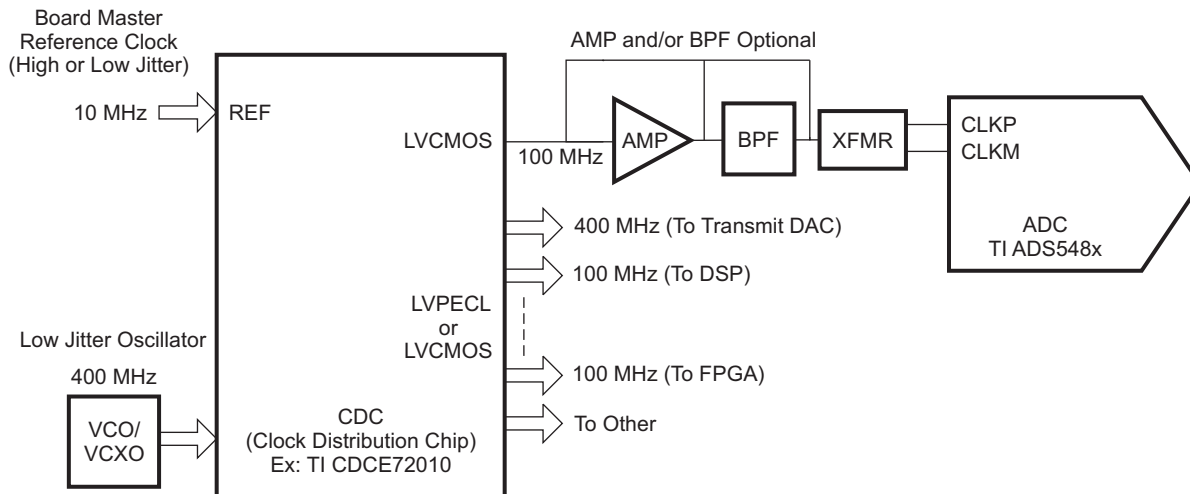

B0268-01

Consult the [CDCE72010 data sheet](#) for proper schematic and specifications regarding allowable input and output frequency and amplitude ranges.

Figure 75. Optimum Jitter Clock Circuit

Digital Outputs

The ADC provides eight LVDS-compatible, offset binary, DDR data outputs (2 bits per LVDS output driver) and a data-ready LVDS signal (DRY). It is recommended to use the DRY signal to capture the output data of the ADS548x (use as a Clock Output). DRY is source-synchronous to the DATA outputs and operates at the same frequency, creating a full-rate DDR interface that updates data on both the rising and falling edges of DRY. It is recommended that the capacitive loading on the digital outputs be minimized. Higher capacitance shortens the data-valid timing window. The values given for timing (see [Figure 1](#)) were obtained with a 5-pF parasitic board capacitance to ground on each LVDS line. When setting the time relationship between DRY and DATA at the receiving device, it is generally recommended that setup time be maximized, but this partially depends on the setup and hold times of the device receiving the digital data. Since DRY and DATA are coincident, it will likely be necessary to delay either DRY such that DATA setup time is maximized.

The LVDS outputs all require an external 100-Ω load between each output pair in order to meet the expected LVDS voltage levels. For long trace lengths, it may be necessary to place a 100-Ω load on each digital output as close to the ADS548x as possible and another 100-Ω differential load at the end of the LVDS transmission line to terminate the transmission line and avoid signal reflections. The effective load in this case reduces the LVDS voltage levels by half. The current of all LVDS drivers is set externally with a resistor connected between the LVDSB (LVDS Bias) pin and ground. Normal LVDS current is 3.5mA per LVDS pair, set with a 10kΩ external resistor. For systems with excessive load capacitance on the LVDS lines, reducing the resistor value in order to increase the LVDS Bias current is allowed to create a stronger LVDS drive capability. For systems with short traces and minimal loading, increasing the resistor in order to decrease the LVDS current is allowable in order to save power. [Table 4](#) provides a sampling of LVDSB resistor values should deviation from the recommended LVDS output current of 3.5mA be considered. It is not recommended to exceed the range listed in the table. If the LVDS bias current is adjusted, the differential load resistance should also be adjusted to maintain voltage levels within the specification for the LVDS outputs. The signal integrity of the LVDS lines on the board layout should be scrutinized to ensure proper LVDS signal integrity exists.

Table 4. Setting the LVDS Current Drive

LVDSB RESISTOR TO GND, Ω	LVDS NOMINAL CURRENT, mA
6k	5.6
8k	4.3
10k (value for normal recommended operation)	3.5
12k	2.8
14k	2.3
16k	2.0
18k	1.7
20k	1.5

Power Supplies and Sleep Modes

The ADS548x uses three power supplies. For the analog portion of the design, a 5-V and 3.3-V supply (AVDD5 and AVDD3) are used, while the digital portion uses a 3.3-V supply (DVDD3). The use of low-noise power supplies with adequate decoupling is recommended. Linear supplies are preferred to switched supplies; switched supplies generate more noise that can be coupled to the ADS548x. However, the PSRR value and plot shown in [Figure 76](#) were obtained without bulk supply decoupling capacitors. When bulk (0.1 μ F) decoupling capacitors are used near the supply pins, the board-level PSRR is much higher than the stated value for the ADC. The user may be able to supply power to the device with a less-than-ideal supply and still achieve very good performance. It is not possible to make a single recommendation for every type of supply and level of decoupling for all systems. If the noise characteristics of the available supplies are understood, a study of the PSRR data for the ADS548x may provide the user with enough information to select noisy supplies if the performance is still acceptable within the frequency range of interest. The power consumption of the ADS548x does not change substantially over clock rate or input frequency.

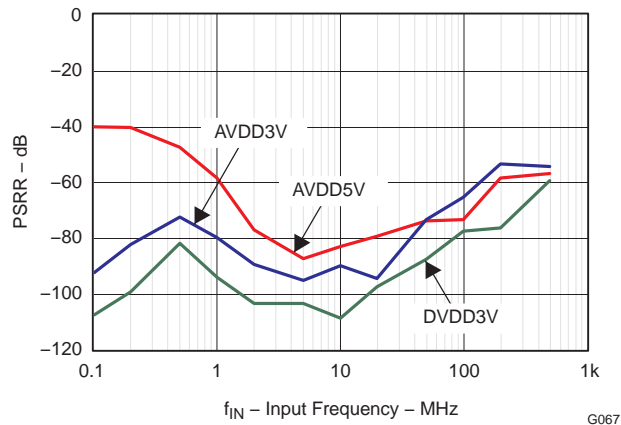

Figure 76. PSRR versus Supply Injected Frequency

Two separate sleep modes are offered. They are differentiated by the amount of power consumed and the time it takes for the ADC to wakeup from sleep. The light sleep mode consumes 605mW and can be used when wakeup of less than 600us is required. Deep sleep consumes 70mW and requires 6ms to wakeup. See the wakeup characteristic at [Figure 57](#). For directions on enabling these modes, see [Table 5](#). The input clock can be in either state when the power down modes are enabled. The device can enter power-down mode whether using internal or external reference. However, the wakeup time from light sleep enabled to external reference mode is dependent on the external reference voltage and is not necessarily 0.6 ms, but should be noticeably faster than deep sleep wakeup. No specific power sequences are required.

Table 5. Power Down and Reference Modes

MODE	PDWNF PIN	PDWNS PIN	POWER CONSUMPTION	WAKEUP TIME
ADC ON - Internal reference	Low	Low	2.2 W	On
ADC ON - External reference	High	High	2.2 W	On
Light sleep	High	Low	605 mW when enabled	0.6 ms
Deep sleep	Low	High	70 mW when enabled	6 ms

Layout Information

The evaluation board represents a good model of how to lay out the printed circuit board (PCB) to obtain the maximum performance from the ADS548x. Follow general design rules, such as the use of multilayer boards, a single ground plane for ADC ground connections, and local decoupling ceramic chip capacitors. The analog input traces should be isolated from any external source of interference or noise, including the digital outputs as well as the clock traces. The clock signal traces should also be isolated from other signals, especially in applications such as high IF sampling where low jitter is required. Besides performance-oriented rules, care must be taken when considering the heat dissipation of the device. The thermal heatsink included on the bottom of the package should be soldered to the board as described in the [PowerPad Package](#) section. See the *ADS548x EVM User Guide* on the [TI web site](#) for the evaluation board schematic.

PowerPAD Package

The PowerPAD package is a thermally-enhanced, standard-size IC package designed to eliminate the use of bulky heatsink and slugs traditionally used in thermal packages. This package can be easily mounted using standard PCB assembly techniques, and can be removed and replaced using standard repair procedures.

The PowerPAD package is designed so that the leadframe die pad (or thermal pad) is exposed on the bottom of the IC. This pad design provides an extremely low thermal resistance path between the die and the exterior of the package. The thermal pad on the bottom of the IC can then be soldered directly to the PCB, using the PCB as a heatsink.

Assembly Process

1. Prepare the PCB top-side etch pattern including etch for the leads as well as the thermal pad as illustrated in the Mechanical Data section (at the end of this data sheet).
2. Place a 6-by-6 array of thermal vias in the thermal pad area. These holes should be 13 mils (0.013 in or 0.3302 mm) in diameter. The small size prevents wicking of the solder through the holes.
3. It is recommended to place a small number of 25 mil (0.025 in or 0.635 mm) diameter holes under the package, but outside the thermal pad area, to provide an additional heat path.
4. Connect all holes (both those inside and outside the thermal pad area) to an internal copper plane (such as a ground plane).
5. Do not use the typical web or spoke via-connection pattern when connecting the thermal vias to the ground plane. The spoke pattern increases the thermal resistance to the ground plane.
6. The top-side solder mask should leave exposed the terminals of the package and the thermal pad area.
7. Cover the entire bottom side of the PowerPAD vias to prevent solder wicking.
8. Apply solder paste to the exposed thermal pad area and all of the package terminals.

For more detailed information regarding the PowerPAD package and its thermal properties, see either the *PowerPAD Made Easy* application brief ([SLMA004](#)) or the *PowerPAD Thermally Enhanced Package* application report ([SLMA002](#)), both available for download at [www.ti.com](#).

DEFINITION OF SPECIFICATIONS

Analog Bandwidth

The analog input frequency at which the power of the fundamental is reduced by 3 dB with respect to the low-frequency value.

Aperture Delay

The delay in time between the rising edge of the input sampling clock and the actual time at which the sampling occurs.

Aperture Uncertainty (Jitter)

The sample-to-sample variation in aperture delay.

Clock Pulse Duration/Duty Cycle

The duty cycle of a clock signal is the ratio of the time the clock signal remains at a logic high (clock pulse duration) to the period of the clock signal, expressed as a percentage.

Differential Nonlinearity (DNL)

An ideal ADC exhibits code transitions at analog input values spaced exactly 1 LSB apart. DNL is the deviation of any single step from this ideal value, measured in units of LSB.

Common-Mode Rejection Ratio (CMRR)

CMRR measures the ability to reject signals that are presented to both analog inputs simultaneously. The injected common-mode frequency level is translated into dBFS, the spur in the output FFT is measured in dBFS, and the difference is the CMRR in dB.

Effective Number of Bits (ENOB)

ENOB is a measure in units of bits of converter performance as compared to the theoretical limit based on quantization noise:

$$\text{ENOB} = (\text{SINAD} - 1.76)/6.02$$

Gain Error

Gain error is the deviation of the ADC actual input full-scale range from its ideal value, given as a percentage of the ideal input full-scale range.

Integral Nonlinearity (INL)

INL is the deviation of the ADC transfer function from a best-fit line determined by a least-squares curve fit of that transfer function. The INL at each analog input value is the difference between the actual transfer function and this best-fit line, measured in units of LSB.

Offset Error

Offset error is the deviation of output code from mid-code when both inputs are tied to common-mode.

Power-Supply Rejection Ratio (PSRR)

PSRR is a measure of the ability to reject frequencies present on the power supply.

The injected frequency level is translated into dBFS, the spur in the output FFT is measured in dBFS, and the difference is the PSRR in dB. The measurement calibrates out the benefit of the board supply decoupling capacitors.

Signal-to-Noise Ratio (SNR)

SNR is the ratio of the power of the fundamental (P_S) to the noise floor power (P_N), excluding the power at dc and in the first five harmonics.

$$\text{SNR} = 10\log_{10} \frac{P_S}{P_N} \quad (4)$$

SNR is either given in units of dBc (dB to carrier) when the absolute power of the fundamental is used as the reference, or dBFS (dB to full-scale) when the power of the fundamental is extrapolated to the converter full-scale range.

Signal-to-Noise and Distortion (SINAD)

SINAD is the ratio of the power of the fundamental (P_S) to the power of all the other spectral components including noise (P_N) and distortion (P_D), but excluding dc.

$$\text{SINAD} = 10\log_{10} \frac{P_S}{P_N + P_D} \quad (5)$$

SINAD is either given in units of dBc (dB to carrier) when the absolute power of the fundamental is used as the reference, or dBFS (dB to full-scale) when the power of the fundamental is extrapolated to the converter full-scale range.

Temperature Drift

Temperature drift (with respect to gain error and offset error) specifies the change from the value at the nominal temperature to the value at T_{MIN} or T_{MAX} . It is computed as the maximum variation the parameters over the whole temperature range divided by $T_{\text{MIN}} - T_{\text{MAX}}$.

Total Harmonic Distortion (THD)

THD is the ratio of the power of the fundamental (P_S) to the power of the first five harmonics (P_D).

$$\text{THD} = 10\log_{10} \frac{P_S}{P_D} \quad (6)$$

THD is typically given in units of dBc (dB to carrier).

Two-Tone Intermodulation Distortion (IMD3)

IMD3 is the ratio of the power of the fundamental (at frequencies f_1, f_2) to the power of the worst spectral component at either frequency $2f_1 - f_2$ or $2f_2 - f_1$. IMD3 is given in units of either dBc (dB to carrier) when the absolute power of the fundamental is used as the reference, or dBFS (dB to full-scale) when the power of the fundamental is extrapolated to the converter full-scale range.

REVISION HISTORY

Changes from Revision B (July 2009) to Revision C	Page
• Changed Signal-to-noise ratio electrical specifications	5
• Changed Spurious-free dynamic range electrical specification	5
• Changed Second-harmonic electrical specifications	5
• Changed Third-harmonic electrical characteristics	6
• Changed Worst harmonic/spur electrical characteristics	6
• Changed Worst harmonic/spur electrical characteristics	6
• Changed Signal-to-noise and distortion electrical characteristics	6
• Changed Effective number of bits electrical characteristics	6
• Changed pin PDWNF from 35 to 34	9
• Changed pin PDWNS from 34 to 35	9

PACKAGING INFORMATION

Orderable part number	Status (1)	Material type (2)	Package Pins	Package qty Carrier	RoHS (3)	Lead finish/ Ball material (4)	MSL rating/ Peak reflow (5)	Op temp (°C)	Part marking (6)
ADS5481IRGCT	Active	Production	VQFN (RGC) 64	250 SMALL T&R	Yes	NIPDAU	Level-3-260C-168 HR	-40 to 85	AZ5481
ADS5482IRGCT	Active	Production	VQFN (RGC) 64	250 SMALL T&R	Yes	NIPDAU	Level-3-260C-168 HR	-40 to 85	AZ5482
ADS5483IRGCT	Active	Production	VQFN (RGC) 64	250 SMALL T&R	Yes	NIPDAU	Level-3-260C-168 HR	-40 to 85	AZ5483

(1) **Status:** For more details on status, see our [product life cycle](#).

(2) **Material type:** When designated, preproduction parts are prototypes/experimental devices, and are not yet approved or released for full production. Testing and final process, including without limitation quality assurance, reliability performance testing, and/or process qualification, may not yet be complete, and this item is subject to further changes or possible discontinuation. If available for ordering, purchases will be subject to an additional waiver at checkout, and are intended for early internal evaluation purposes only. These items are sold without warranties of any kind.

(3) **RoHS values:** Yes, No, RoHS Exempt. See the [TI RoHS Statement](#) for additional information and value definition.

(4) **Lead finish/Ball material:** Parts may have multiple material finish options. Finish options are separated by a vertical ruled line. Lead finish/Ball material values may wrap to two lines if the finish value exceeds the maximum column width.

(5) **MSL rating/Peak reflow:** The moisture sensitivity level ratings and peak solder (reflow) temperatures. In the event that a part has multiple moisture sensitivity ratings, only the lowest level per JEDEC standards is shown. Refer to the shipping label for the actual reflow temperature that will be used to mount the part to the printed circuit board.

(6) **Part marking:** There may be an additional marking, which relates to the logo, the lot trace code information, or the environmental category of the part.

Multiple part markings will be inside parentheses. Only one part marking contained in parentheses and separated by a "~" will appear on a part. If a line is indented then it is a continuation of the previous line and the two combined represent the entire part marking for that device.

Important Information and Disclaimer: The information provided on this page represents TI's knowledge and belief as of the date that it is provided. TI bases its knowledge and belief on information provided by third parties, and makes no representation or warranty as to the accuracy of such information. Efforts are underway to better integrate information from third parties. TI has taken and continues to take reasonable steps to provide representative and accurate information but may not have conducted destructive testing or chemical analysis on incoming materials and chemicals. TI and TI suppliers consider certain information to be proprietary, and thus CAS numbers and other limited information may not be available for release.

In no event shall TI's liability arising out of such information exceed the total purchase price of the TI part(s) at issue in this document sold by TI to Customer on an annual basis.

GENERIC PACKAGE VIEW

RGC 64

VQFN - 1 mm max height

9 x 9, 0.5 mm pitch

PLASTIC QUAD FLATPACK - NO LEAD

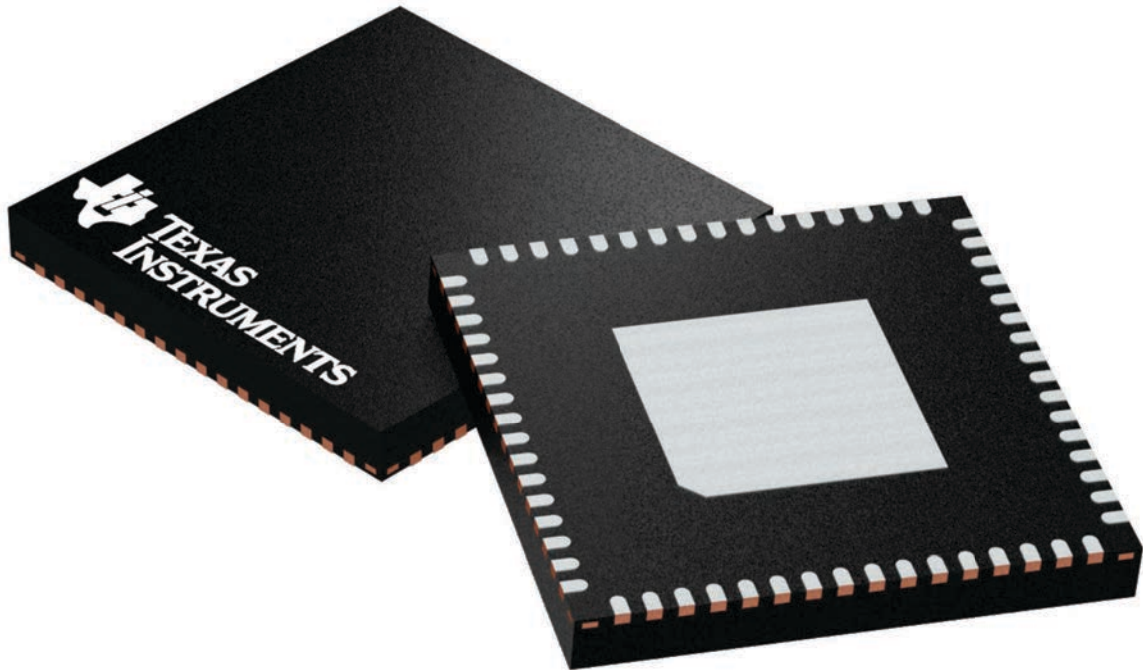

Images above are just a representation of the package family, actual package may vary.
Refer to the product data sheet for package details.

4224597/A

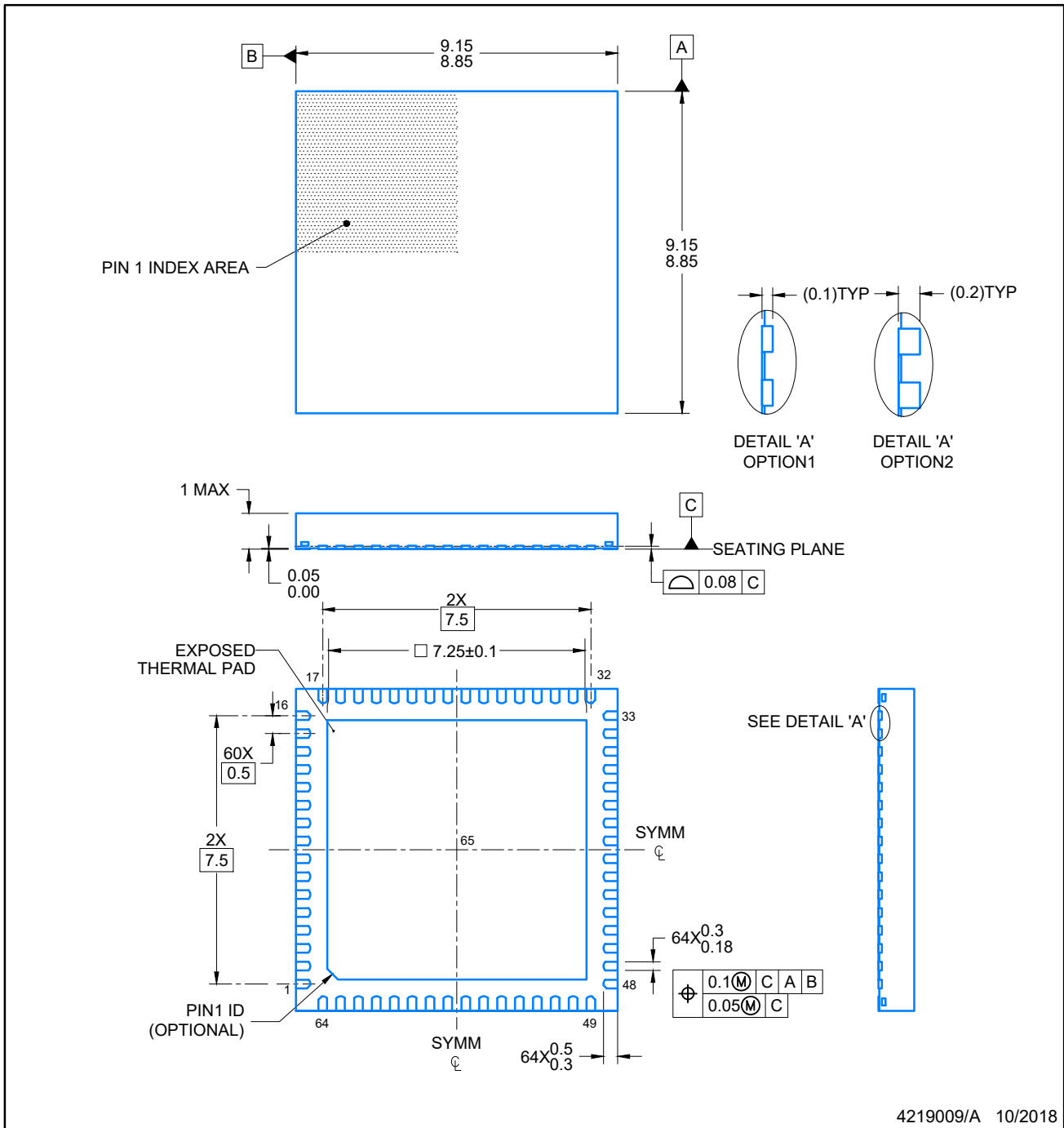

NOTES:

1. All linear dimensions are in millimeters. Any dimensions in parenthesis are for reference only. Dimensioning and tolerancing per ASME Y14.5M.
2. This drawing is subject to change without notice.
3. The package thermal pad must be soldered to the printed circuit board for optimal thermal and mechanical performance.

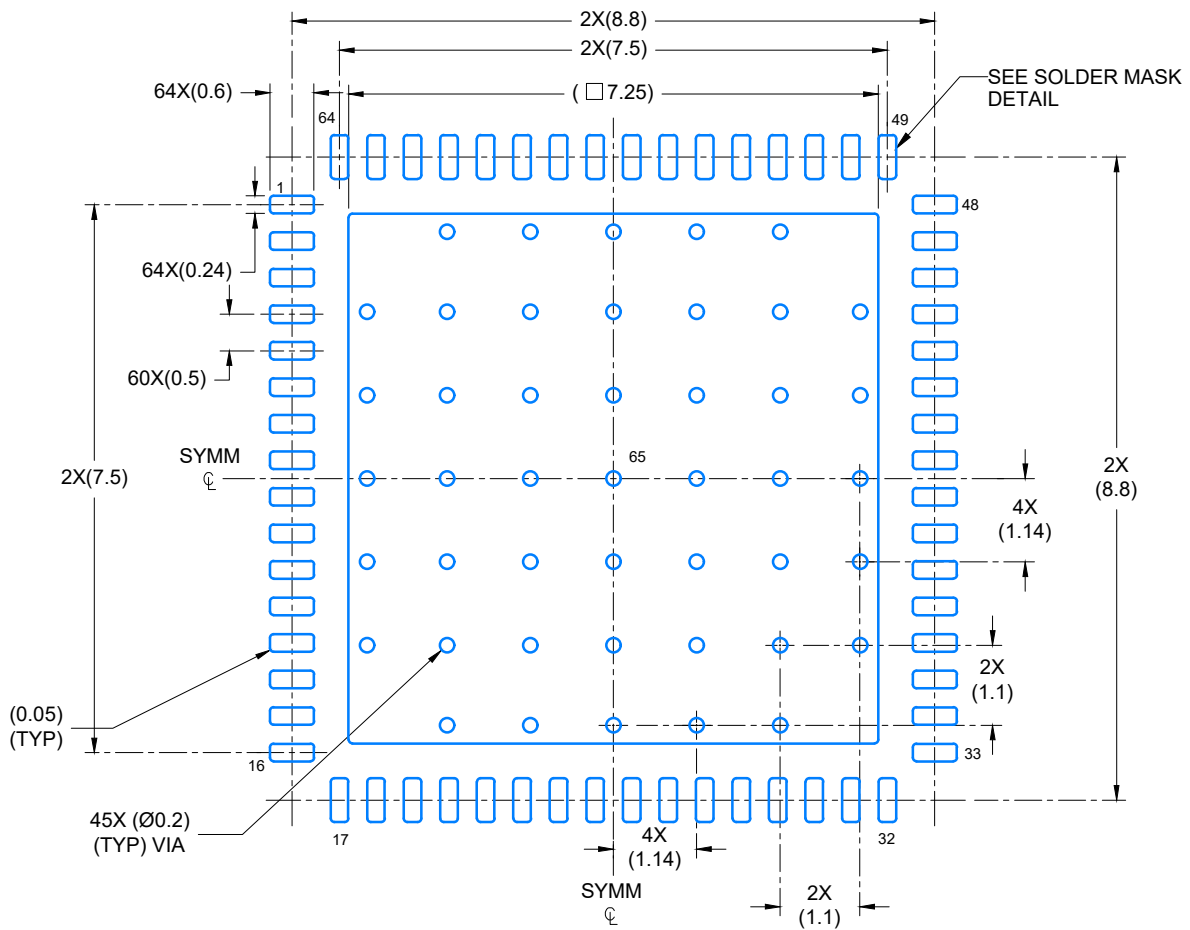

LAND PATTERN EXAMPLE
SCALE: 10X

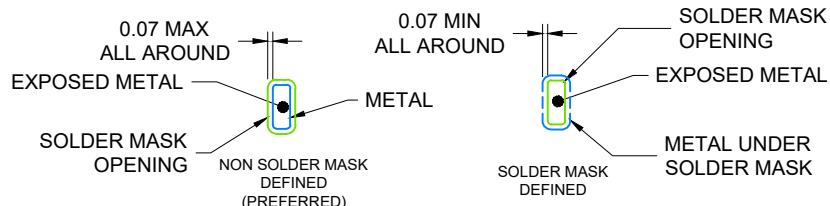

SOLDER MASK DETAILS

4219009/A 10/2018

NOTES: (continued)

4. This package is designed to be soldered to a thermal pad on the board. For more information, see Texas Instruments literature number SLUA271 (www.ti.com/lit/sluea271).
5. Vias are optional depending on application, refer to device data sheet. If any vias are implemented, refer to their locations shown on this view. It is recommended that vias under paste be filled, plugged or tented.

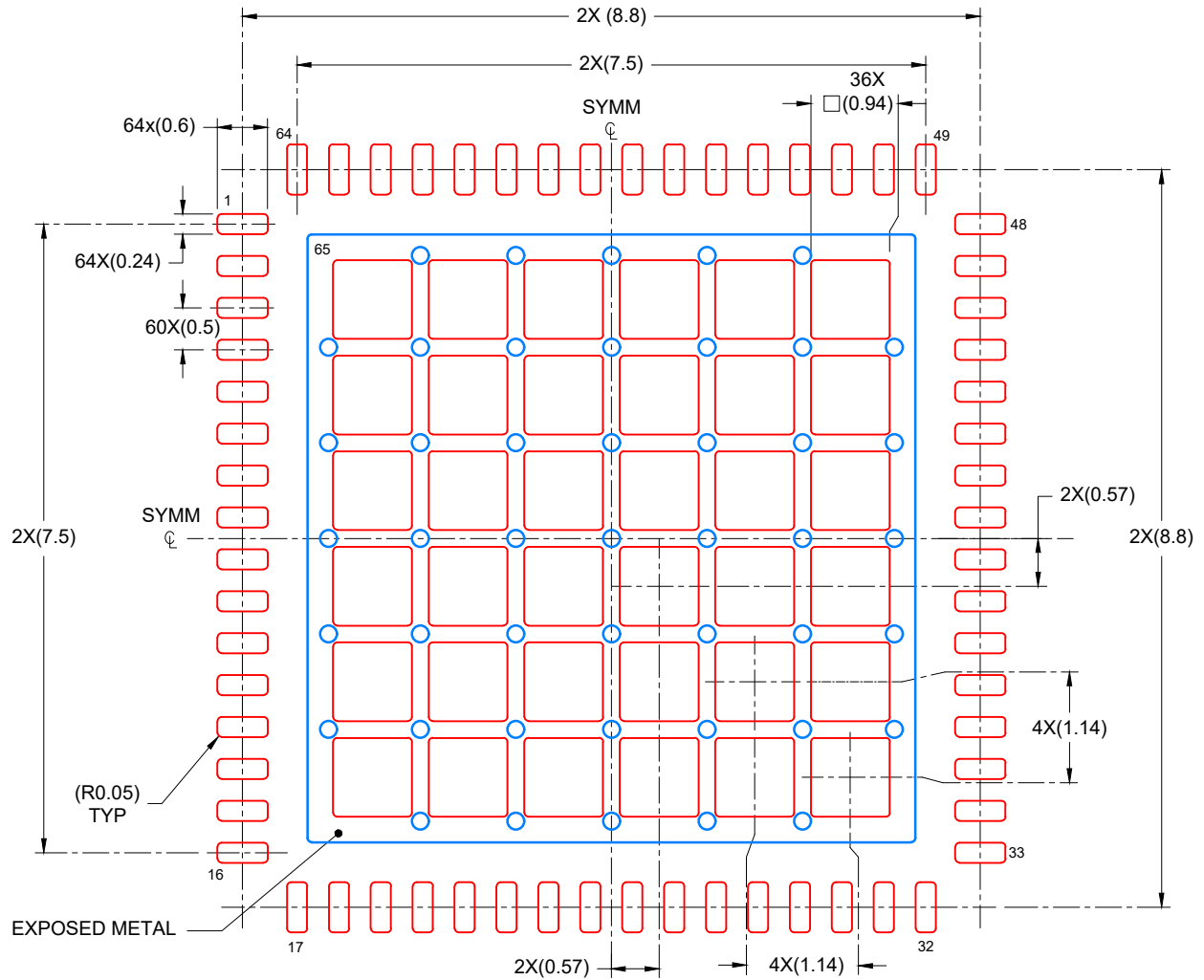

SOLDER PASTE EXAMPLE
 BASED ON 0.125 mm THICK STENCIL

EXPOSED PAD
 60% PRINTED COVERAGE BY AREA
 SCALE: 12X

4219009/A 10/2018

NOTES: (continued)

6. Laser cutting apertures with trapezoidal walls and rounded corners may offer better paste release. IPC-7525 may have alternate design recommendations.

IMPORTANT NOTICE AND DISCLAIMER

TI PROVIDES TECHNICAL AND RELIABILITY DATA (INCLUDING DATA SHEETS), DESIGN RESOURCES (INCLUDING REFERENCE DESIGNS), APPLICATION OR OTHER DESIGN ADVICE, WEB TOOLS, SAFETY INFORMATION, AND OTHER RESOURCES "AS IS" AND WITH ALL FAULTS, AND DISCLAIMS ALL WARRANTIES, EXPRESS AND IMPLIED, INCLUDING WITHOUT LIMITATION ANY IMPLIED WARRANTIES OF MERCHANTABILITY, FITNESS FOR A PARTICULAR PURPOSE OR NON-INFRINGEMENT OF THIRD PARTY INTELLECTUAL PROPERTY RIGHTS.

These resources are intended for skilled developers designing with TI products. You are solely responsible for (1) selecting the appropriate TI products for your application, (2) designing, validating and testing your application, and (3) ensuring your application meets applicable standards, and any other safety, security, regulatory or other requirements.

These resources are subject to change without notice. TI grants you permission to use these resources only for development of an application that uses the TI products described in the resource. Other reproduction and display of these resources is prohibited. No license is granted to any other TI intellectual property right or to any third party intellectual property right. TI disclaims responsibility for, and you will fully indemnify TI and its representatives against, any claims, damages, costs, losses, and liabilities arising out of your use of these resources.

TI's products are provided subject to [TI's Terms of Sale](#) or other applicable terms available either on [ti.com](https://www.ti.com) or provided in conjunction with such TI products. TI's provision of these resources does not expand or otherwise alter TI's applicable warranties or warranty disclaimers for TI products.

TI objects to and rejects any additional or different terms you may have proposed.

Mailing Address: Texas Instruments, Post Office Box 655303, Dallas, Texas 75265

Copyright © 2025, Texas Instruments Incorporated