

xWR1843 Evaluation Module (xWR1843BOOST) Single-Chip mmWave Sensing Solution

The xWR1843 BoosterPack™ from Texas Instruments™ is an easy-to-use evaluation board for the xWR1843 mmWave sensing device, with direct connectivity to the microcontroller (MCU) LaunchPad™ Development Kit. The BoosterPack contains everything required to start developing software for on-chip C67x DSP core and low-power Arm® R4F controllers, including onboard emulation for programming and debugging as well as onboard buttons and LEDs for quick integration of a simple user interface.

Contents

1	Getting Started	2
	1.1 Introduction	2
	1.2 Key Features	2
	1.3 Kit Contents.....	2
2	Hardware.....	3
	2.1 Block Diagram.....	5
	2.2 Power Connections.....	5
	2.3 Connectors	6
	2.4 PC Connection	9
	2.5 Connecting the BoosterPack to the DCA1000	9
	2.6 Connecting the BoosterPack to the LaunchPad or the MMWAVE-DEVPACK.....	10
	2.7 Antenna.....	11
	2.8 Jumpers, Switches, and LEDs.....	13
3	Design Files and Software Tools.....	16
	3.1 Hardware	16
	3.2 Software, Development Tools, and Example Code.....	16
4	Design Revision History	18
5	Mechanical Mounting of PCB.....	18
6	PCB Storage and Handling Recommendations	19
7	Troubleshooting	19
8	References	19

Trademarks

BoosterPack, Texas Instruments, LaunchPad, Code Composer Studio are trademarks of Texas Instruments.

Arm is a registered trademark of Arm Limited.

Windows is a registered trademark of Microsoft Corporation.

All other trademarks are the property of their respective owners.

1 Getting Started

1.1 Introduction

The xWR1843 BoosterPack from Texas Instruments is an easy-to-use evaluation board for the xWR1843 mmWave sensing device, with direct connectivity to the microcontroller (MCU) LaunchPad Development Kit. The BoosterPack contains everything required to start developing software for on-chip C67x DSP core and low-power ARM R4F controllers, including onboard emulation for programming and debugging as well as onboard buttons and LEDs for quick integration of a simple user interface.

The standard 20-pin BoosterPack headers make the device compatible with a wide variety of TI MCU LaunchPads and enables easy prototyping.

1.2 Key Features

- Two 20-pin LaunchPad connectors that leverages the ecosystem of the TI LaunchPad
- XDS110 based JTAG emulation with a serial port for onboard QSPI flash programming
- Back-channel UART through USB-to-PC for logging purposes
- Onboard antenna
- 60-pin, high-density (HD) connector for raw analog-to-digital converter (ADC) data over LVDS and trace-data capability
- Onboard CAN-FD transceiver
- One button and two LEDs for basic user interface
- 5-V power jack to power the board

1.3 Kit Contents

The following items are included with the xWR1843BOOST kit.

- xWR1843 evaluation board
- Mounting brackets, screws, and nuts to place the printed-circuit board (PCB) vertical
- Micro USB cable to connect to PC

NOTE: A 5-V, > 2.5-A supply brick with a 2.1-mm barrel jack (center positive) is not included. TI recommends using an external power supply that complies with applicable regional safety standards, such as UL, CSA, VDE, CCC, PSE, and more. The length of the power cable should be < 3 m.

1.3.1 mmWave Proximity Demo

TI provides sample demo codes to easily get started with the xWR1843 evaluation module (EVM) and to experience the functionality of the xWR1843 radar sensor. For details on getting started with these demos, see www.ti.com/tool/mmwave-sdk.

2 Hardware

Figure 1 and Figure 2 show the front and rear view of the EVM, respectively.

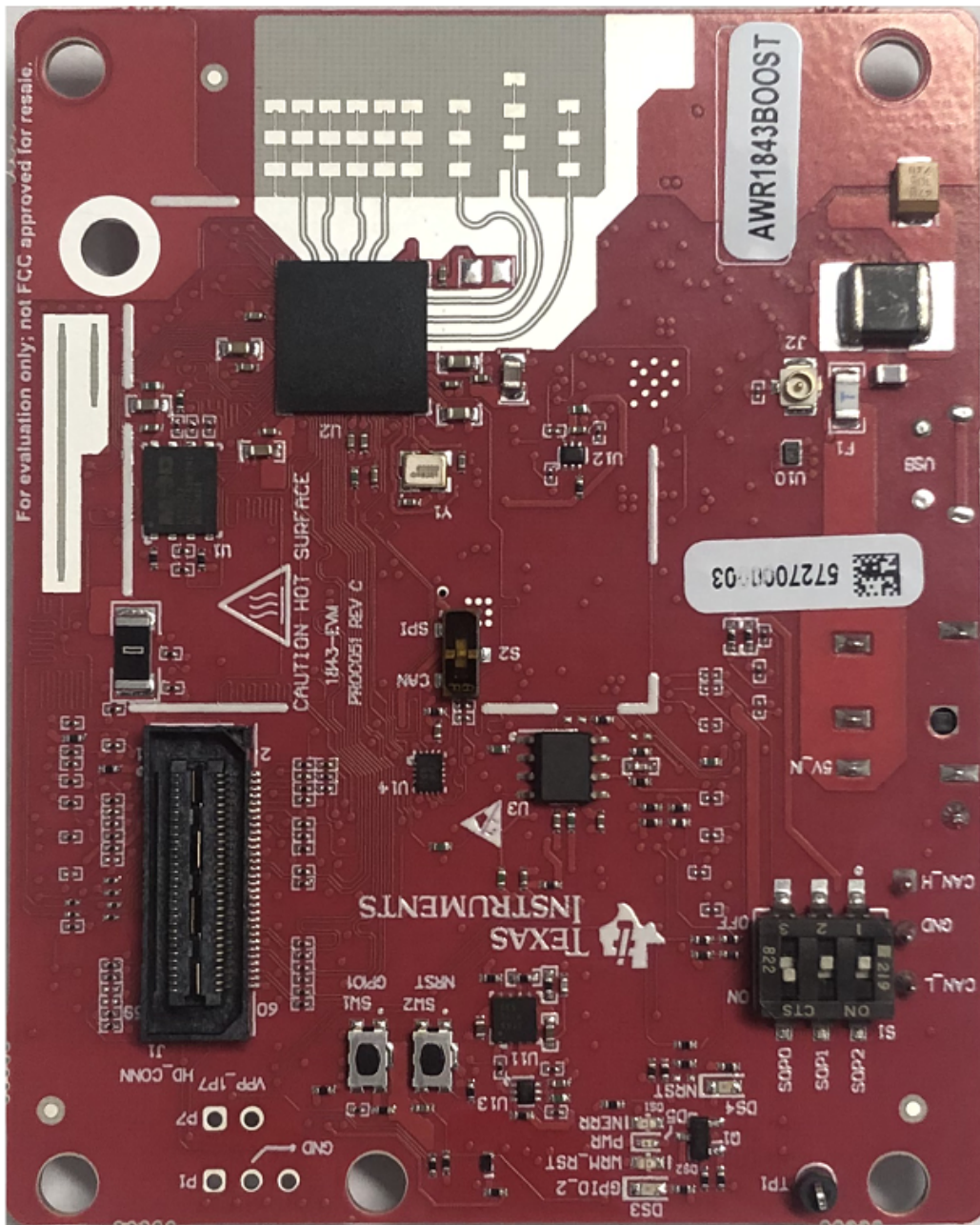

Figure 1. EVM (Front)

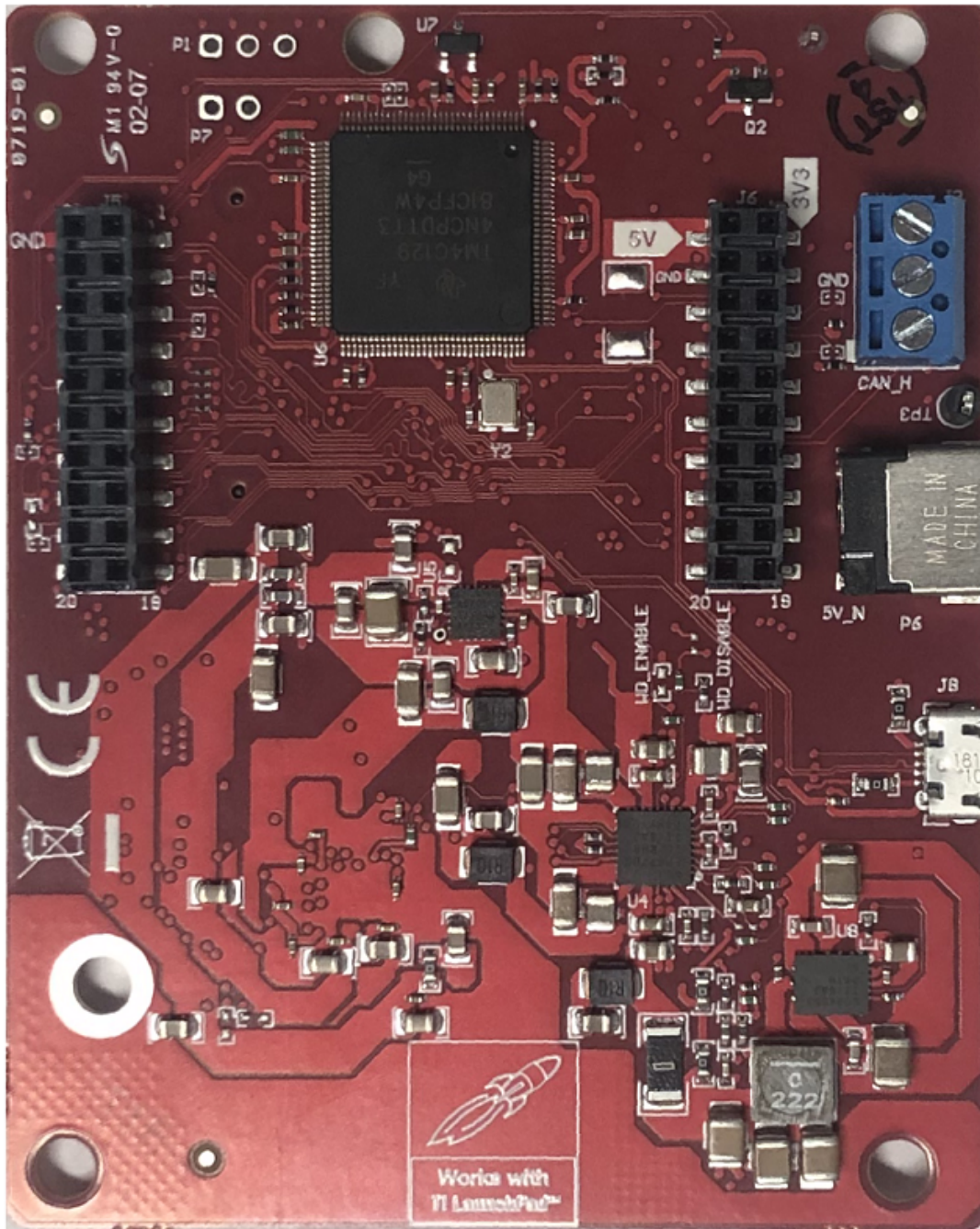

Figure 2. EVM (Rear)

2.1 Block Diagram

Figure 3 shows the block diagram.

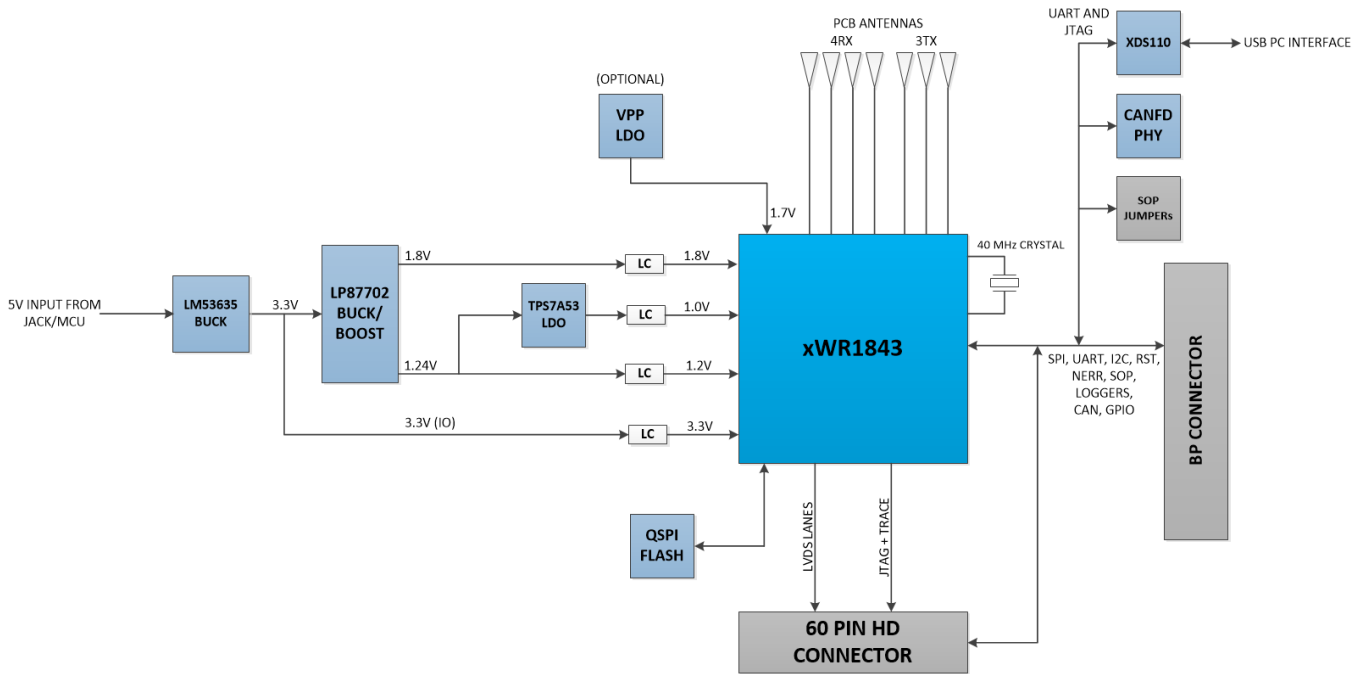

Figure 3. Block Diagram

2.2 Power Connections

The BoosterPack is powered by the 5-V power jack (2.5-A current limit), shown in Figure 4. As soon as the power is provided, the NRST and 5-V LEDs should glow, indicating that the board is powered on.

NOTE: After the 5-V power supply is provided to the EVM, it is recommended to press the NRST switch (SW2) one time to ensure a reliable boot-up state.

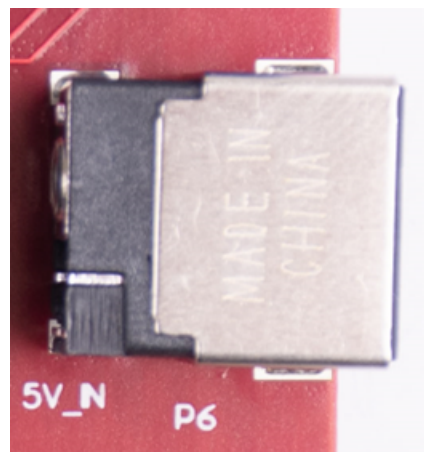

Figure 4. Power Connector

2.3 Connectors

2.3.1 20-Pin BoosterPack Connectors

The BoosterPack has the standard LaunchPad connectors (J5 and J6, shown in [Figure 5](#)) that enable it to be directly connected to all TI MCU LaunchPads. While connecting the BoosterPack to other LaunchPads, ensure the pin-1 orientation is correct by matching the 3V3 and 5-V signal marking on the boards.

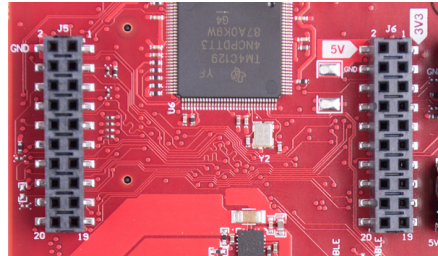

Figure 5. 20-Pin BoosterPack Connectors

[Table 1](#) and [Table 2](#) provide the connector-pin information.

Table 1. J5 Connector Pin

Pin Number	Description	Pin Number	Description
1	NERROUT	2	GND
3	NERRIN	4	DSS LOGGER
5	MCUCLK OUT	6	SPI_CS
7	NC	8	GPIO01
9	MSS LOGGER	10	nRESET
11	WARMRST	12	SPI_MOSI
13	BSS LOGGER	14	SPI_MISO
15	SOP2	16	HOSTINT
17	SOP1	18	GPIO02
19	SOP0	20	NC

Table 2. J6 Connector Pin

Pin Number	Description	Pin Number	Description
1	3V3	2	5 V
3	NC	4	GND
5	RS232RX (Tx from AWR device)	6	ANA1 ⁽¹⁾
7	RS232RX (Rx into AWR device)	8	ANA2 ⁽¹⁾
9	SYNC_IN	10	ANA3 ⁽¹⁾
11	NC	12	ANA4 ⁽¹⁾
13	SPI_CLK	14	PGOOD (onboard VIO) ⁽²⁾
15	GPIO0	16	PMIC Enable ⁽³⁾
17	SCL	18	SYNC_OUT
19	SDA	20	PMIC CLK OUT

⁽¹⁾ Voltage input to the GPADC available on the xWR1843.

⁽²⁾ Indicates the state of the onboard VIO supply for the AWR device coming from the onboard PMIC. A HIGH on the PGOOD signal (3.3 V) indicates the supply is stable. Because the I/Os are not failsafe, the MCU must not drive any I/O signals to the AWR device before this I/O supply is stable to avoid leakage current into the I/Os.

⁽³⁾ Controls the onboard PMIC enable. The MCU can use this to shut down the PMIC and AWR device during the periods it does not use the AWR device and save power. The power up of the PMIC takes approximately 5 ms once the enable signal is made high.

2.3.2 60-Pin HD Connector

The 60-pin HD connector provides the high speed LVDS data, control signals (SPI, UART, I²C, NRST, NERR, SOPs) and JTAG debug signals. The connector can be connected to the MMWAVE-DEVPACK board to further get to the standard TSW1400 EVM. [Figure 6](#) shows the HD connector, and [Table 3](#) provides the connector information.

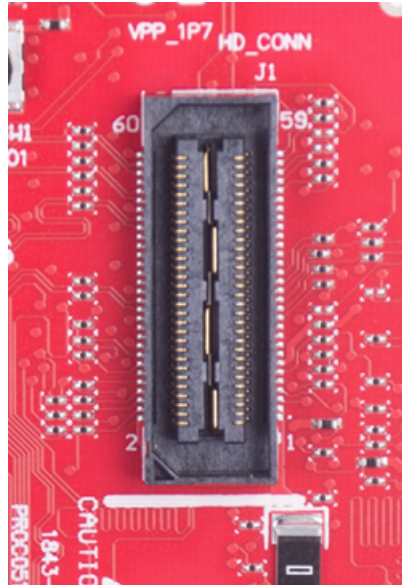

Figure 6. HD Connector

Table 3. J1 Connector Pin

Pin Number	Description	Pin Number	Description
1	5V	2	5V
3	5V	4	TDO
5	TDI	6	TCK
7	SPI_CS	8	TMS
9	SPI_CLK	10	HOSTINT
11	SPI_MOSI	12	SPI_MISO
13	PGOOD (onboard VIO) ⁽¹⁾	14	NERROUT
15	DMM_CLK	16	SYNC_IN
17	DMM_SYNC	18	GND
19	TRACE_DATA0	20	NC
21	TRACE_DATA1	22	NC
23	TRACE_DATA2	24	GND
25	TRACE_DATA3	26	LVDS_FRCLKP
27	TRACE_DATA4	28	LVDS_FRCLKM
29	TRACE_DATA5	30	GND
31	TRACE_DATA6	32	NC
33	TRACE_DATA7	34	NC
35	TRACE_DATA8	36	GND
37	TRACE_DATA9	38	NC
39	TRACE_DATA10	40	NC
41	TRACE_DATA11	42	GND

⁽¹⁾ Indicates the state of the onboard VIO supply for the AWR device coming from the onboard PMIC. A HIGH on the PGOOD signal (3.3 V) indicates the supply is stable. Because the I/Os are not failsafe, the MCU must not drive any I/O signals to the AWR device before this I/O supply is stable to avoid leakage current into the I/Os.

Table 3. J1 Connector Pin (continued)

Pin Number	Description	Pin Number	Description
43	TRACE_DATA12	44	LVDS_CLKP
45	TRACE_DATA13	46	LVDS_CLKM
47	TRACE_DATA14	48	GND
49	TRACE_DATA15	50	LVDS_1P
51	I2C_SDA	52	LVDS_1M
53	I2C_SCL	54	GND
55	RS232RX (Rx into AWR device)	56	LVDS_0P
57	RS232TX (Tx from AWR device)	58	LVDS_0M
59	nRESET	60	GND

2.3.3 CAN Interface Connector

The J3 connector provides the CAN_L and CAN_H signals from the onboard CAND-FD transceiver (TCAN1042HGVDRQ1). These signals can be directly wired to the CAN bus.

Because the digital CAN signals (Tx and Rx) are muxed with the SPI interface signals on the AWR device, one of the two paths must be selected. This is done by placing the switch S2 on the "CAN" position.

Figure 7 shows the CAN connector.

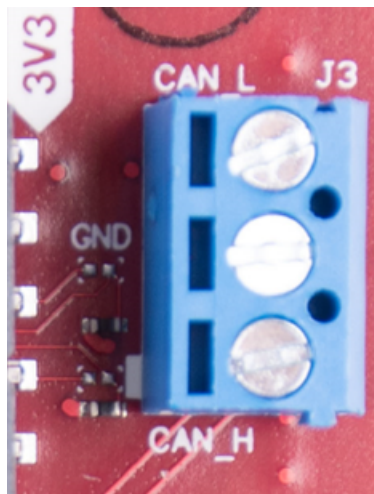
Figure 7. CAN Connector

2.4 PC Connection

The connectivity is provided through the micro USB connector over the onboard XDS110 (TM4C1294NCPDT) emulator. This connection provides the following interfaces to the PC:

- JTAG for Code Composer Studio™ (CCS) connectivity
- UART1 for flashing the onboard serial flash, downloading FW through Radar Studio, and getting application data sent through the UART
- MSS logger UART (can be used to get MSS code logs on the PC)

When the USB is connected to the PC, the device manager should recognize the following COM ports, shown in [Figure 8](#):

- XDS110 Class Application/User UART – UART1 port
- XDS110 Class Auxiliary Data Port – MSS logger port

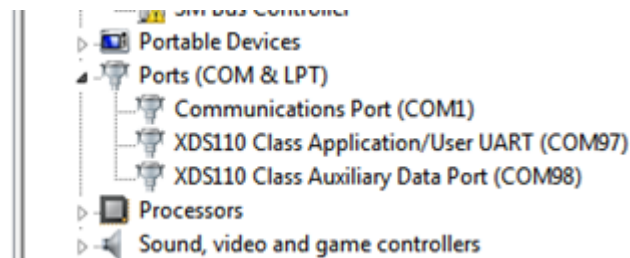

Figure 8. COM Ports

If Windows® is unable to recognize the COM ports, users must install the EMU pack available at [XDS Emulation Software Package](#).

2.5 Connecting the BoosterPack to the DCA1000

The BoosterPack can be connected to the DCA1000 FPGA platform to allow for LVDS streaming over Ethernet. For detailed information on how to capture LVDS data using the DCA1000, see the following resources.

- [DCA1000 Product Page](#)
- [DCA1000 User's Guide](#)
- [DCA1000 Training Video](#)

2.6 Connecting the BoosterPack to the LaunchPad or the MMWAVE-DEVPACK

The development pack may be required with the BoosterPack for the following use cases:

- Connecting to Radar Studio
Radar Studio TSW1400+Devpack, mmwave Studio TSW1400+Devpack/DCA1000 tool is a tool that provides capability to configure the mmWave front end from the PC. This tool is available in the [DFP package](#) and refers to single dfp landing page for both pieces of software.
- Capturing high-speed LVDS data using the SW1400, TSW1400 or DCA1000 FPGA platform from TI (see [High Speed Data Capture and Pattern Generation Platform](#)).
The TSW1400 FPGA platform allows users to capture the raw ADC data over the high-speed debug interface and post process it in the PC.
- Getting DSP trace data through the MIPI 60-pin interface
- Use the DMM interface

This BoosterPack can be stacked on top of the Launchpad or the [MMWAVE-DEVPACK](#) by using the two 20-pin connectors. The connectors do not have a key to prevent the misalignment of the pins or reverse connection. Hence, care must be taken to ensure reverse mounting does not take place.

On the xWR1843 BoosterPack, TI has provided 3V3 markings near pin 1, shown in [Figure 9](#). The same marking is provided on compatible LaunchPads (must be aligned before powering up the boards).

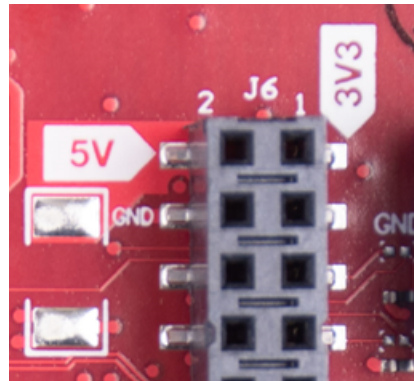

Figure 9. 3V3 and 5V Marking on BoosterPack

For details on these use cases, see the [MMWAVE-DEVPACK User's Guide](#).

NOTE: The DCA1000 EVM has internal DEVPACK functionality. For more information, see the [DCA1000EVM Data Capture Card User's Guide](#).

2.7 Antenna

The BoosterPack includes onboard-etched antennas for the four receivers and three transmitters that enable tracking multiple objects with their distance and angle information. This antenna design enables estimation of distance and elevation angle that enables object detection in a three-dimensional plane. [Figure 10](#) shows the PCB antennas.

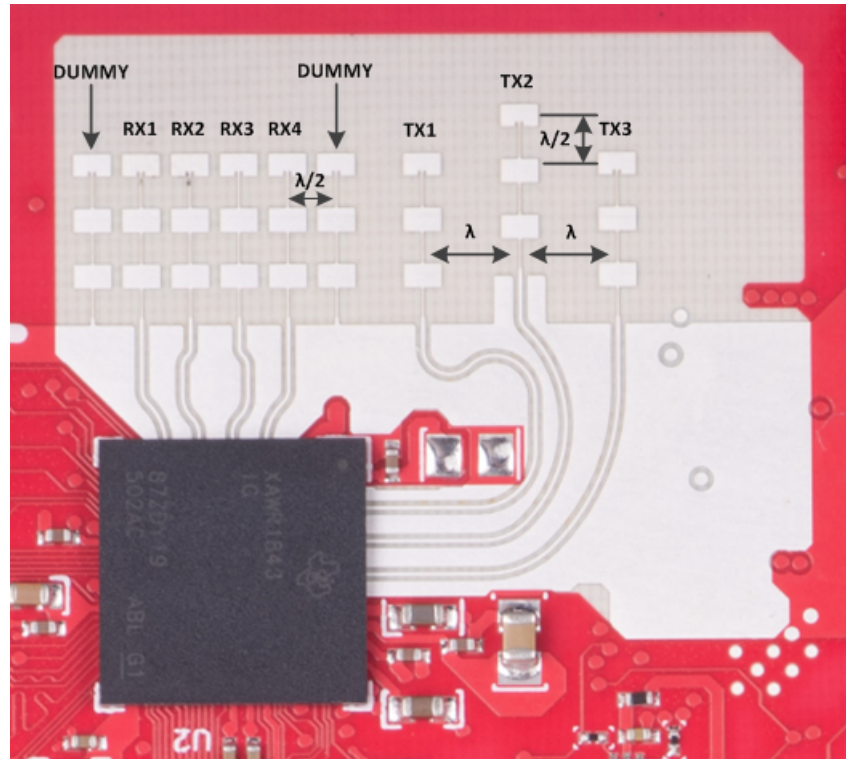

Figure 10. RX and TX Antennas

The antenna peak gain is > 10.5 dBi across the frequency band of 76 to 81 GHz. The radiation pattern of the antenna in the horizontal plane (H-plane) and elevation plane (E-plane) is as shown in [Figure 11](#) and [Figure 12](#).

The beamwidth of the antenna design can be determined from the radiation patterns. For example, at 78 GHz, based on 3-dB drop in the gain as compared to bore sight, the horizontal 3dB-beamwidth is approximately ± 28 degrees (see [Figure 11](#)), and elevation 3dB-beamwidth is approximately ± 14 degrees (see [Figure 12](#)). Similarly, the horizontal 6dB-beamwidth is approximately ± 50 degrees (see [Figure 11](#)) and the elevation 6dB-beamwidth is approximately ± 20 degrees (see [Figure 12](#)).

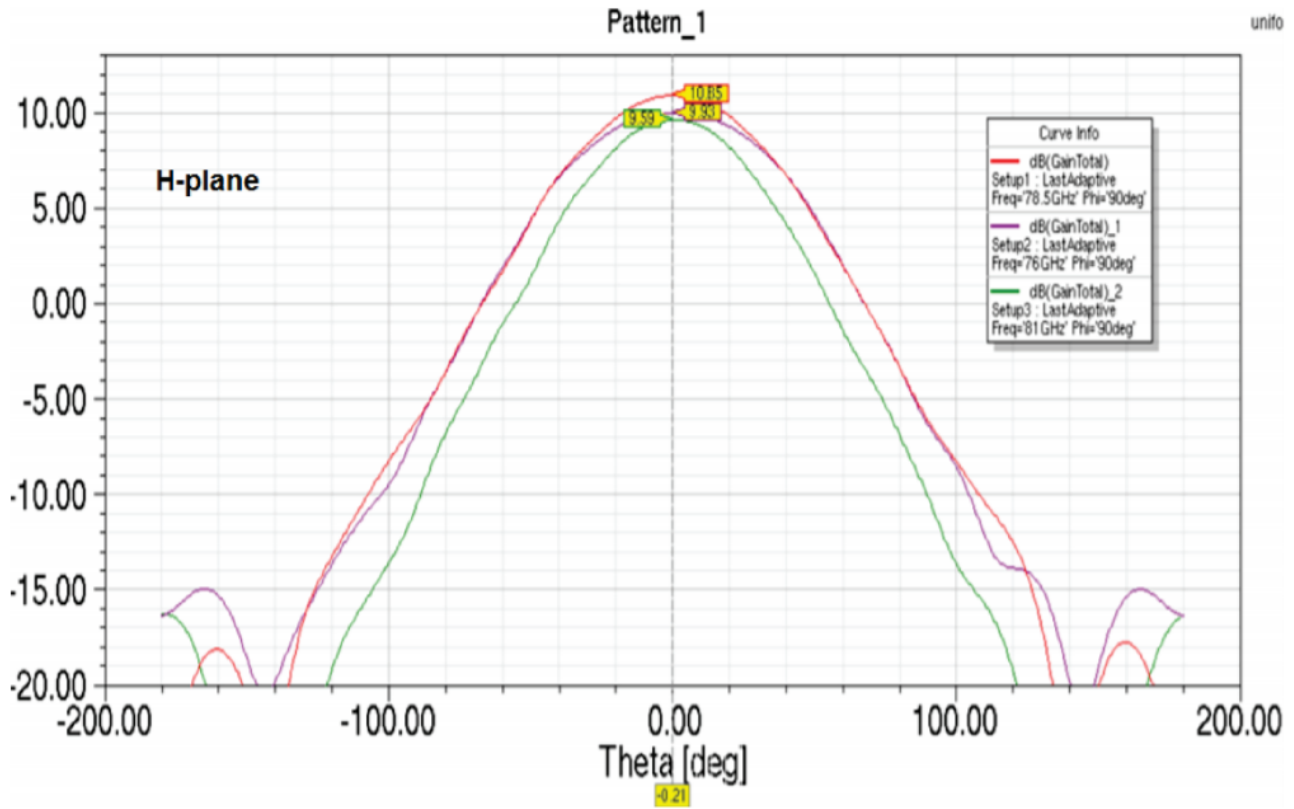

Figure 11. Antenna Pattern

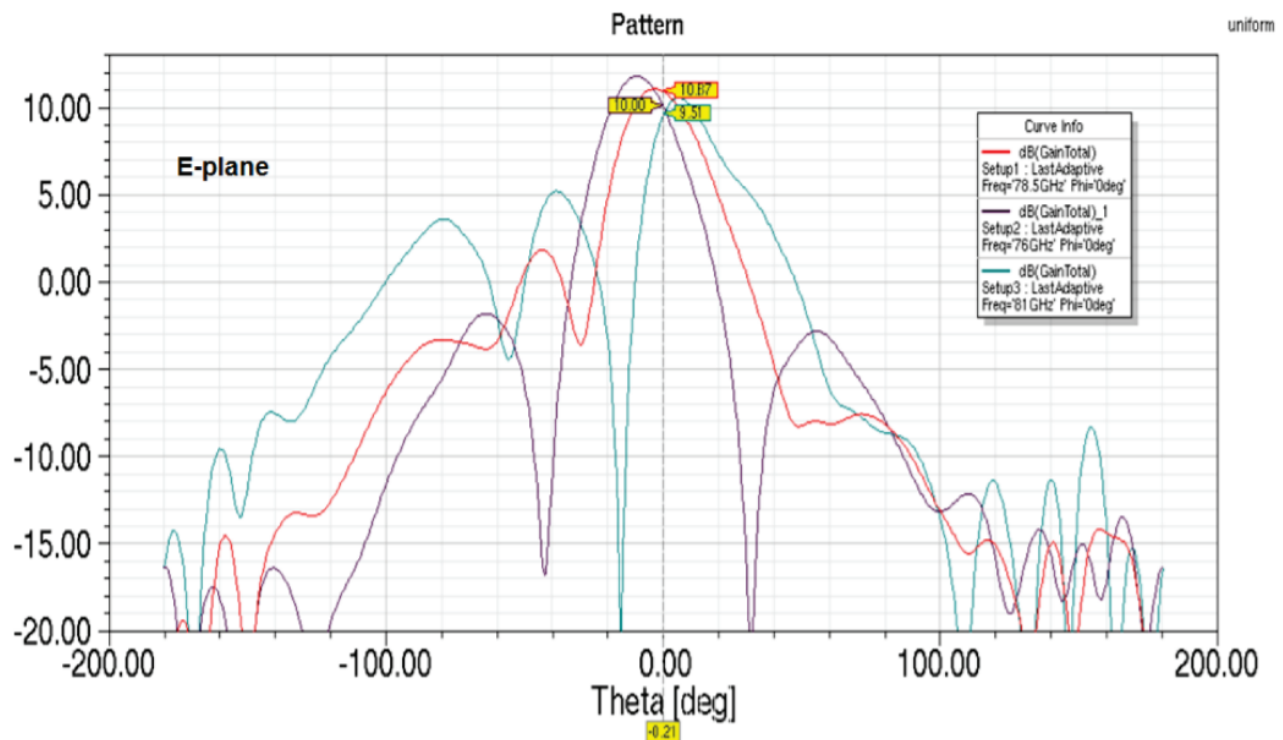

Figure 12. Antenna Pattern

NOTE: The xWR1843BOOST has been testing in the 76- to 77-GHz band and in the 77- to 81-GHz band across the temperature range of -20°C to 60°C.

NOTE: During operation, a minimum separation distance of 5 centimeters should be maintained between the user and the EVM.

2.8 Jumpers, Switches, and LEDs

2.8.1 Sense-on-Power (SOP) Jumpers

The xWR1843 device can be set to operate in three different modes based on the state of the SOP lines. These lines are sensed only during boot up of the AWR device. The state of the device is detailed by [Table 4](#).

The SOP mode is set using switch S1. When the switch position is 'ON', this refers to a 1. When the switch position is 'OFF', this refers to a 0.

Table 4. SOP Switch Information

Reference	Usage	Comments
SOP 2	SOP[2:0]	101 (SOP mode 5) = flash programming
SOP 1		001 (SOP mode 4) = functional mode
SOP 0		011 (SOP mode 2) = debug mode

[Figure 13](#) shows the SOP jumpers.

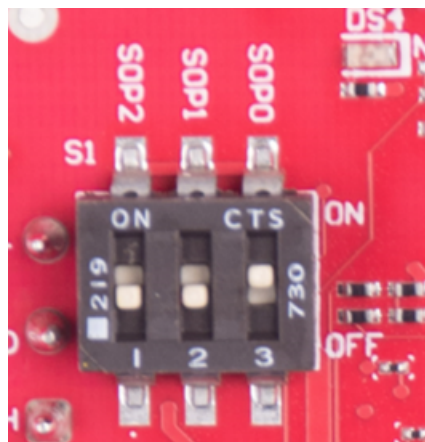

Figure 13. SOP Jumpers

2.8.2 Current Measurement

The R156 resistor enables the measurement of the current being consumed by the reference design (AWR device, PMIC, and LDOs) at a 3.3-V level.

To measure the current, resistor R156 must be removed and a series ammeter can be put across the resistor pins (shown in [Figure 14](#)).

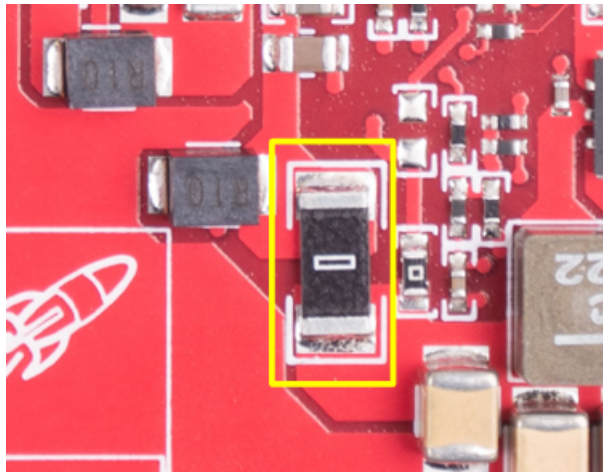

Figure 14. Current Measure Resistor

2.8.3 Push Buttons and LEDs

[Table 5](#) provides the switch and LED information.

Table 5. Switch and LED Information

Reference	Usage	Comments
SW2	RESET	Used to RESET the xWR1843 device. This signal is also brought out on the 20-pin connector and 60-pin HD connector so an external processor can control the AWR device. The onboard XDS110 can also use this reset.
SW1	GPIO_1	When pushed, the GPIO_1 is pulled to V _{CC} .
DS2	Warm reset indication	This LED indicates the warm reset is triggered.
DS4	nRESET	This LED is used to indicate the state of nRESET pin. If this LED is glowing, the device is out of reset. This LED will glow only after the 5-V supply is provided.
DS1	Nerr_OUT	Glow if there is any HW error in the AWR device
DS3	GPIO_1	Glow when the GPIO is logic-1
D5	PWR	This LED indicates the presence of the 3.3-V supply

Figure 15 through Figure 20 show the location of switches and LEDs.



Figure 15. SW1



Figure 16. SW2



Figure 17. DS2



Figure 18. DS4



Figure 19. DS1



Figure 20. DS3

2.8.4 Selection Between SPI and CAN Interface

The SPI and CAN interface are muxed on the same lines on the xWR1843 device. Based on the configuration, the user can select if the pins E14 and D13 must be connected to the 20-pin/HD connectors to provide the SPI interface OR to the onboard CANFD PHY (U3). This selection is done by the S2 switch.

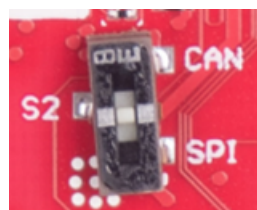

Figure 21. S2 Switch to Select Between SPI or CAN Interface

3 Design Files and Software Tools

3.1 Hardware

To view the schematics, assembly drawings, and BOM, see [AWR1843BOOST Schematic, Assembly Files, and BOM](#).

To view the design database and layout details, see [AWR1843BOOST Hardware Files](#).

NOTE: Boards with a Rev 'D' sticker have had capacitor C56 (VBGAP decoupling capacitor) changed from 0.22 μ F to 0.047 μ F (part number CGA2B3X7R1H473K050BB). TI recommends that customers incorporate this change with an equivalent capacitor in their designs.

3.2 Software, Development Tools, and Example Code

To enable quick development of end applications on the C67x DSP and R4F core in the xWR1843, TI provides a software development kit (SDK) that includes demo codes, software drivers, emulation packages for debug, and more. These can be found at [mmwave-sdk](#).

3.2.1 LDO Bypass Requirement

The xWR1843BOOST utilizes a 1.0-V supply on the RF1 and RF2 power rails. To support the third transmitter, the VOUT_PA output is connected to the RF2 power rail. For best performance and to prevent damage to the device, select the 'RF LDO Bypass Enable' and 'PA LDO I/P Disable' options in the Static Configuration when using mmWave Studio. Additionally, the LDO bypass can be configured using the AWR_RF_LDO_BYPASS_SB API. To enable the RF LDO Bypass and PA LDO I/P Disable through the API, issue an `ar1.RfLdoBypassConfig(0x3)` command.

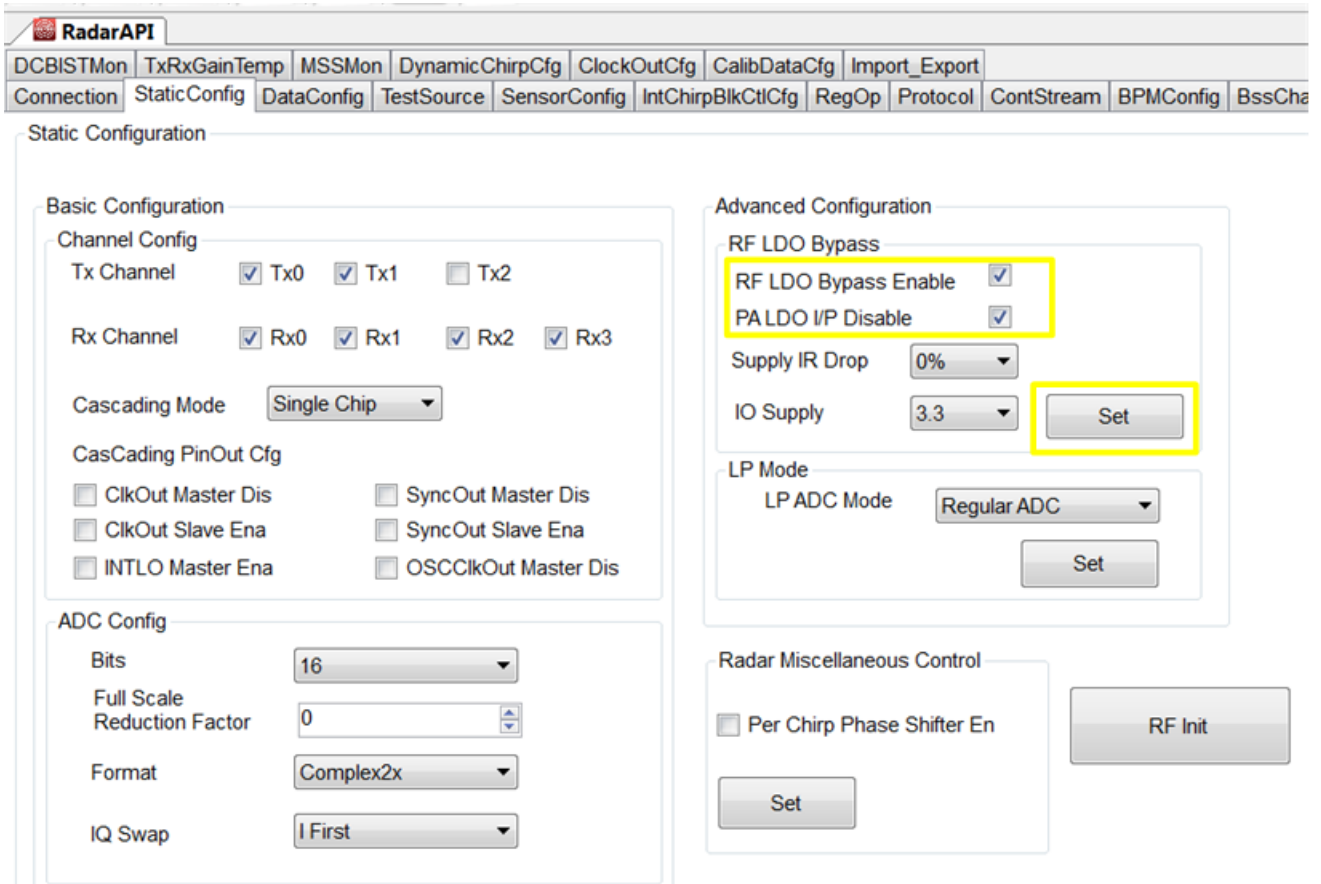

Figure 22. LDO Bypass Enable

3.2.2 Power Supply Optimization

For best transient supply settling at the start of the chirp, the [idle time + TX start time] can be set to a value < 10 μ sec. In this configuration, the AWR firmware keeps some of the RF blocks ON between the chirps. For idle time + Tx start time > 10 μ sec, the blocks are turned off for power saving. In this case, TI recommends adding an additional resistive load on the 1-V LDO oputput; the available R83 pad can be used for this purpose. The value of the resistance can be between 10 to 30 Ω , depending on the idle time setting. The other option is to disable the inter-chirp power save feature of the AWR device using the AWR DYNAMICPOWERSAVE CONF SET SB API.

The LC filter on the 1-V and 1.8-V supplies is used to filter the 4-Mhz ripple from the switcher. There could be small ringing behavior at the point of transient load change. If this is impacting the RX sampled data, the ADC start time can be increased to a point where the supply is settled within 5%, or the inductance value can be reduced to reduce the ringing (which may come at the expense or poorer 4-Mhz filtering).

4 Design Revision History

Table 6. Design Revision History

PCB Revision	Change Description
Rev C	Increased LDO output cap to 47 μ F
	Added two optional 100- μ F LDO output caps
	Added 10- μ F cap to LDO output
	Added test pad to LDO PG pin
	Connected LDO DNC pads to GND for thermal performance
	Added optional bleeed resistor on LDO output
	Changed 1-V filtering to BLM18 inductor
	Added 22- μ F caps to 1-V, 1.24-C, and 1.8-V LC filters
	Added 10- μ F cpas to 3.3-V and 1.24-V LC filters
	Added additional 10- μ F caps to 1-V LC fitlers

5 Mechanical Mounting of PCB

The field of view of the radar sensor is orthogonal to the PCB. To enable easy measurements on the sensing objects on the horizontal plane, the PCB can be mounted vertically. The L-brackets provided with the xWR1843 EVM kit, along with the screws and nuts help in the vertical mounting of the EVM. [Figure 23](#) shows how the L-brackets can be assembled.

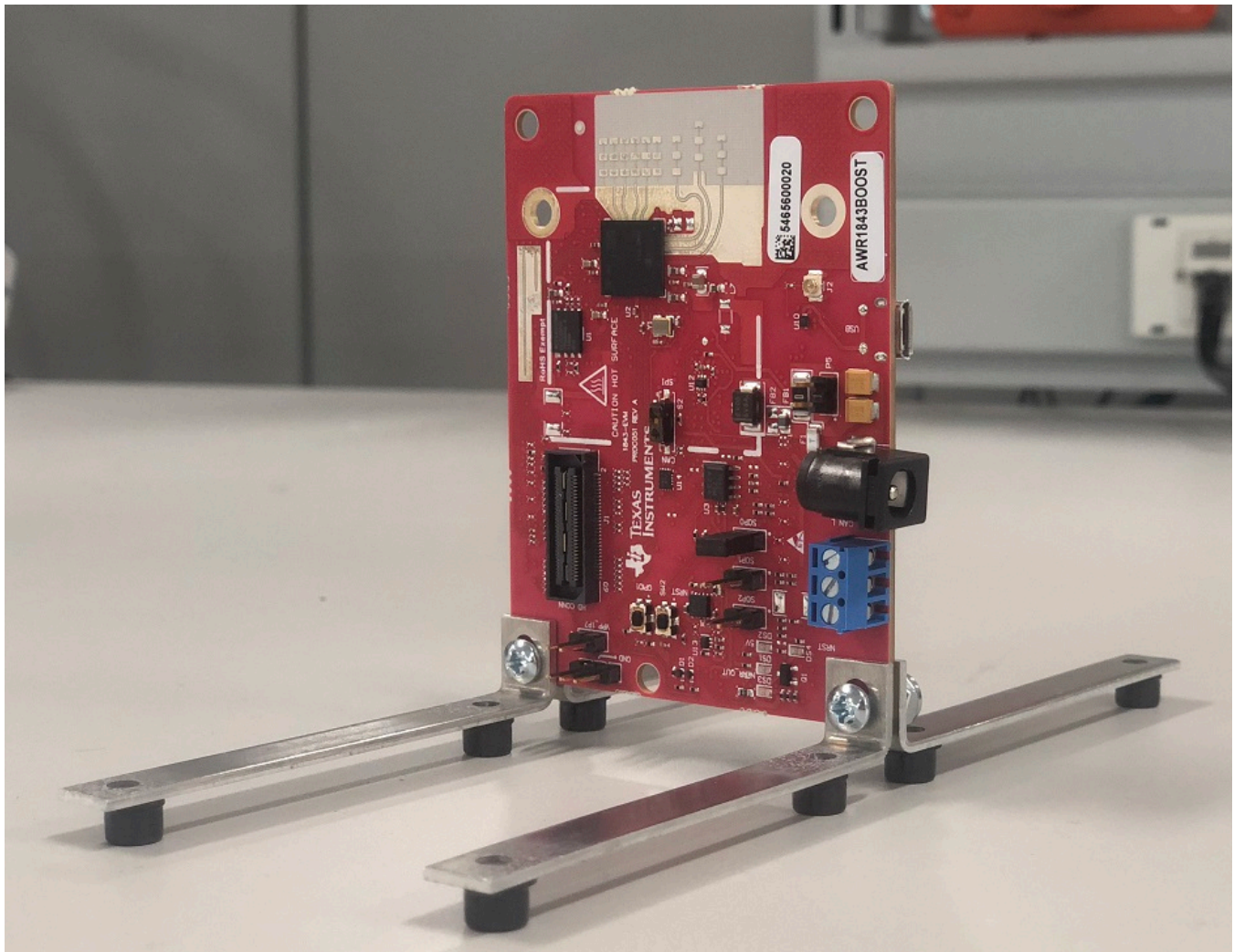

Figure 23. Vertical Assembly of the EVM

6 PCB Storage and Handling Recommendations

The immersion silver finish of the PCB provides a better high-frequency performance, but is also prone to oxidation in open environments. This oxidation causes the surface around the antenna region to blacken. To avoid oxidation, the PCB should be stored in an ESD cover and kept at a controlled room temperature with low humidity conditions. All ESD precautions must be taken while using and handling the EVM.

7 Troubleshooting

EVM Board Power-up Failure

See [Section 2.2](#) for desired power connections. Please ensure NRST and PWR LEDs glow brightly. When a nonfunctional or insufficient current capacity power supply is used with the EVM, the EVM LEDs will not turn on. See [Section 2.8.3](#) for LED information.

8 References

[DCA1000EVM Data Capture Card User's Guide](#)

Revision History

NOTE: Page numbers for previous revisions may differ from page numbers in the current version.

Changes from A Revision (August 2019) to B Revision	Page
• Added Note.	16

STANDARD TERMS FOR EVALUATION MODULES

1. *Delivery:* TI delivers TI evaluation boards, kits, or modules, including any accompanying demonstration software, components, and/or documentation which may be provided together or separately (collectively, an "EVM" or "EVMs") to the User ("User") in accordance with the terms set forth herein. User's acceptance of the EVM is expressly subject to the following terms.
 - 1.1 EVMs are intended solely for product or software developers for use in a research and development setting to facilitate feasibility evaluation, experimentation, or scientific analysis of TI semiconductors products. EVMs have no direct function and are not finished products. EVMs shall not be directly or indirectly assembled as a part or subassembly in any finished product. For clarification, any software or software tools provided with the EVM ("Software") shall not be subject to the terms and conditions set forth herein but rather shall be subject to the applicable terms that accompany such Software
 - 1.2 EVMs are not intended for consumer or household use. EVMs may not be sold, sublicensed, leased, rented, loaned, assigned, or otherwise distributed for commercial purposes by Users, in whole or in part, or used in any finished product or production system.
2. *Limited Warranty and Related Remedies/Disclaimers:*
 - 2.1 These terms do not apply to Software. The warranty, if any, for Software is covered in the applicable Software License Agreement.
 - 2.2 TI warrants that the TI EVM will conform to TI's published specifications for ninety (90) days after the date TI delivers such EVM to User. Notwithstanding the foregoing, TI shall not be liable for a nonconforming EVM if (a) the nonconformity was caused by neglect, misuse or mistreatment by an entity other than TI, including improper installation or testing, or for any EVMs that have been altered or modified in any way by an entity other than TI, (b) the nonconformity resulted from User's design, specifications or instructions for such EVMs or improper system design, or (c) User has not paid on time. Testing and other quality control techniques are used to the extent TI deems necessary. TI does not test all parameters of each EVM. User's claims against TI under this Section 2 are void if User fails to notify TI of any apparent defects in the EVMs within ten (10) business days after delivery, or of any hidden defects with ten (10) business days after the defect has been detected.
 - 2.3 TI's sole liability shall be at its option to repair or replace EVMs that fail to conform to the warranty set forth above, or credit User's account for such EVM. TI's liability under this warranty shall be limited to EVMs that are returned during the warranty period to the address designated by TI and that are determined by TI not to conform to such warranty. If TI elects to repair or replace such EVM, TI shall have a reasonable time to repair such EVM or provide replacements. Repaired EVMs shall be warranted for the remainder of the original warranty period. Replaced EVMs shall be warranted for a new full ninety (90) day warranty period.

WARNING

Evaluation Kits are intended solely for use by technically qualified, professional electronics experts who are familiar with the dangers and application risks associated with handling electrical mechanical components, systems, and subsystems.

User shall operate the Evaluation Kit within TI's recommended guidelines and any applicable legal or environmental requirements as well as reasonable and customary safeguards. Failure to set up and/or operate the Evaluation Kit within TI's recommended guidelines may result in personal injury or death or property damage. Proper set up entails following TI's instructions for electrical ratings of interface circuits such as input, output and electrical loads.

NOTE:

EXPOSURE TO ELECTROSTATIC DISCHARGE (ESD) MAY CAUSE DEGRADATION OR FAILURE OF THE EVALUATION KIT; TI RECOMMENDS STORAGE OF THE EVALUATION KIT IN A PROTECTIVE ESD BAG.

3 Regulatory Notices:

3.1 United States

3.1.1 Notice applicable to EVMs not FCC-Approved:

FCC NOTICE: This kit is designed to allow product developers to evaluate electronic components, circuitry, or software associated with the kit to determine whether to incorporate such items in a finished product and software developers to write software applications for use with the end product. This kit is not a finished product and when assembled may not be resold or otherwise marketed unless all required FCC equipment authorizations are first obtained. Operation is subject to the condition that this product not cause harmful interference to licensed radio stations and that this product accept harmful interference. Unless the assembled kit is designed to operate under part 15, part 18 or part 95 of this chapter, the operator of the kit must operate under the authority of an FCC license holder or must secure an experimental authorization under part 5 of this chapter.

3.1.2 For EVMs annotated as FCC – FEDERAL COMMUNICATIONS COMMISSION Part 15 Compliant:

CAUTION

This device complies with part 15 of the FCC Rules. Operation is subject to the following two conditions: (1) This device may not cause harmful interference, and (2) this device must accept any interference received, including interference that may cause undesired operation.

Changes or modifications not expressly approved by the party responsible for compliance could void the user's authority to operate the equipment.

FCC Interference Statement for Class A EVM devices

NOTE: This equipment has been tested and found to comply with the limits for a Class A digital device, pursuant to part 15 of the FCC Rules. These limits are designed to provide reasonable protection against harmful interference when the equipment is operated in a commercial environment. This equipment generates, uses, and can radiate radio frequency energy and, if not installed and used in accordance with the instruction manual, may cause harmful interference to radio communications. Operation of this equipment in a residential area is likely to cause harmful interference in which case the user will be required to correct the interference at his own expense.

FCC Interference Statement for Class B EVM devices

NOTE: This equipment has been tested and found to comply with the limits for a Class B digital device, pursuant to part 15 of the FCC Rules. These limits are designed to provide reasonable protection against harmful interference in a residential installation. This equipment generates, uses and can radiate radio frequency energy and, if not installed and used in accordance with the instructions, may cause harmful interference to radio communications. However, there is no guarantee that interference will not occur in a particular installation. If this equipment does cause harmful interference to radio or television reception, which can be determined by turning the equipment off and on, the user is encouraged to try to correct the interference by one or more of the following measures:

- Reorient or relocate the receiving antenna.
- Increase the separation between the equipment and receiver.
- Connect the equipment into an outlet on a circuit different from that to which the receiver is connected.
- Consult the dealer or an experienced radio/TV technician for help.

3.2 Canada

3.2.1 For EVMs issued with an Industry Canada Certificate of Conformance to RSS-210 or RSS-247

Concerning EVMs Including Radio Transmitters:

This device complies with Industry Canada license-exempt RSSs. Operation is subject to the following two conditions:

(1) this device may not cause interference, and (2) this device must accept any interference, including interference that may cause undesired operation of the device.

Concernant les EVMs avec appareils radio:

Le présent appareil est conforme aux CNR d'Industrie Canada applicables aux appareils radio exempts de licence. L'exploitation est autorisée aux deux conditions suivantes: (1) l'appareil ne doit pas produire de brouillage, et (2) l'utilisateur de l'appareil doit accepter tout brouillage radioélectrique subi, même si le brouillage est susceptible d'en compromettre le fonctionnement.

Concerning EVMs Including Detachable Antennas:

Under Industry Canada regulations, this radio transmitter may only operate using an antenna of a type and maximum (or lesser) gain approved for the transmitter by Industry Canada. To reduce potential radio interference to other users, the antenna type and its gain should be so chosen that the equivalent isotropically radiated power (e.i.r.p.) is not more than that necessary for successful communication. This radio transmitter has been approved by Industry Canada to operate with the antenna types listed in the user guide with the maximum permissible gain and required antenna impedance for each antenna type indicated. Antenna types not included in this list, having a gain greater than the maximum gain indicated for that type, are strictly prohibited for use with this device.

Concernant les EVMs avec antennes détachables

Conformément à la réglementation d'Industrie Canada, le présent émetteur radio peut fonctionner avec une antenne d'un type et d'un gain maximal (ou inférieur) approuvé pour l'émetteur par Industrie Canada. Dans le but de réduire les risques de brouillage radioélectrique à l'intention des autres utilisateurs, il faut choisir le type d'antenne et son gain de sorte que la puissance isotrope rayonnée équivalente (p.i.r.e.) ne dépasse pas l'intensité nécessaire à l'établissement d'une communication satisfaisante. Le présent émetteur radio a été approuvé par Industrie Canada pour fonctionner avec les types d'antenne énumérés dans le manuel d'usage et ayant un gain admissible maximal et l'impédance requise pour chaque type d'antenne. Les types d'antenne non inclus dans cette liste, ou dont le gain est supérieur au gain maximal indiqué, sont strictement interdits pour l'exploitation de l'émetteur.

3.3 Japan

3.3.1 *Notice for EVMs delivered in Japan:* Please see http://www.tij.co.jp/llds/ti_ja/general/eStore/notice_01.page 日本国内に輸入される評価用キット、ボードについては、次のところをご覧ください。

<https://www.ti.com/ja-jp/legal/notice-for-evaluation-kits-delivered-in-japan.html>

3.3.2 *Notice for Users of EVMs Considered "Radio Frequency Products" in Japan:* EVMs entering Japan may not be certified by TI as conforming to Technical Regulations of Radio Law of Japan.

If User uses EVMs in Japan, not certified to Technical Regulations of Radio Law of Japan, User is required to follow the instructions set forth by Radio Law of Japan, which includes, but is not limited to, the instructions below with respect to EVMs (which for the avoidance of doubt are stated strictly for convenience and should be verified by User):

1. Use EVMs in a shielded room or any other test facility as defined in the notification #173 issued by Ministry of Internal Affairs and Communications on March 28, 2006, based on Sub-section 1.1 of Article 6 of the Ministry's Rule for Enforcement of Radio Law of Japan,
2. Use EVMs only after User obtains the license of Test Radio Station as provided in Radio Law of Japan with respect to EVMs, or
3. Use of EVMs only after User obtains the Technical Regulations Conformity Certification as provided in Radio Law of Japan with respect to EVMs. Also, do not transfer EVMs, unless User gives the same notice above to the transferee. Please note that if User does not follow the instructions above, User will be subject to penalties of Radio Law of Japan.

【無線電波を送信する製品の開発キットをお使いになる際の注意事項】 開発キットの中には技術基準適合証明を受けていないものがあります。技術適合証明を受けていないものご使用に際しては、電波法遵守のため、以下のいずれかの措置を取っていただく必要がありますのでご注意ください。

1. 電波法施行規則第6条第1項第1号に基づく平成18年3月28日総務省告示第173号で定められた電波暗室等の試験設備でご使用いただく。
2. 実験局の免許を取得後ご使用いただく。
3. 技術基準適合証明を取得後ご使用いただく。

なお、本製品は、上記の「ご使用にあたっての注意」を譲渡先、移転先に通知しない限り、譲渡、移転できないものとします。

上記を遵守頂けない場合は、電波法の罰則が適用される可能性があることをご留意ください。日本テキサス・イ

ンスツルメンツ株式会社

東京都新宿区西新宿 6 丁目 2 4 番 1 号

西新宿三井ビル

3.3.3 *Notice for EVMs for Power Line Communication:* Please see http://www.tij.co.jp/llds/ti_ja/general/eStore/notice_02.page

電力線搬送波通信についての開発キットをお使いになる際の注意事項については、次のところをご覧ください。 <https://www.ti.com/ja-jp/legal/notice-for-evaluation-kits-for-power-line-communication.html>

3.4 European Union

3.4.1 *For EVMs subject to EU Directive 2014/30/EU (Electromagnetic Compatibility Directive):*

This is a class A product intended for use in environments other than domestic environments that are connected to a low-voltage power-supply network that supplies buildings used for domestic purposes. In a domestic environment this product may cause radio interference in which case the user may be required to take adequate measures.

-
4. *EVM Use Restrictions and Warnings:*
 - 4.1 EVMS ARE NOT FOR USE IN FUNCTIONAL SAFETY AND/OR SAFETY CRITICAL EVALUATIONS, INCLUDING BUT NOT LIMITED TO EVALUATIONS OF LIFE SUPPORT APPLICATIONS.
 - 4.2 User must read and apply the user guide and other available documentation provided by TI regarding the EVM prior to handling or using the EVM, including without limitation any warning or restriction notices. The notices contain important safety information related to, for example, temperatures and voltages.
 - 4.3 *Safety-Related Warnings and Restrictions:*
 - 4.3.1 User shall operate the EVM within TI's recommended specifications and environmental considerations stated in the user guide, other available documentation provided by TI, and any other applicable requirements and employ reasonable and customary safeguards. Exceeding the specified performance ratings and specifications (including but not limited to input and output voltage, current, power, and environmental ranges) for the EVM may cause personal injury or death, or property damage. If there are questions concerning performance ratings and specifications, User should contact a TI field representative prior to connecting interface electronics including input power and intended loads. Any loads applied outside of the specified output range may also result in unintended and/or inaccurate operation and/or possible permanent damage to the EVM and/or interface electronics. Please consult the EVM user guide prior to connecting any load to the EVM output. If there is uncertainty as to the load specification, please contact a TI field representative. During normal operation, even with the inputs and outputs kept within the specified allowable ranges, some circuit components may have elevated case temperatures. These components include but are not limited to linear regulators, switching transistors, pass transistors, current sense resistors, and heat sinks, which can be identified using the information in the associated documentation. When working with the EVM, please be aware that the EVM may become very warm.
 - 4.3.2 EVMs are intended solely for use by technically qualified, professional electronics experts who are familiar with the dangers and application risks associated with handling electrical mechanical components, systems, and subsystems. User assumes all responsibility and liability for proper and safe handling and use of the EVM by User or its employees, affiliates, contractors or designees. User assumes all responsibility and liability to ensure that any interfaces (electronic and/or mechanical) between the EVM and any human body are designed with suitable isolation and means to safely limit accessible leakage currents to minimize the risk of electrical shock hazard. User assumes all responsibility and liability for any improper or unsafe handling or use of the EVM by User or its employees, affiliates, contractors or designees.
 - 4.4 User assumes all responsibility and liability to determine whether the EVM is subject to any applicable international, federal, state, or local laws and regulations related to User's handling and use of the EVM and, if applicable, User assumes all responsibility and liability for compliance in all respects with such laws and regulations. User assumes all responsibility and liability for proper disposal and recycling of the EVM consistent with all applicable international, federal, state, and local requirements.
 5. *Accuracy of Information:* To the extent TI provides information on the availability and function of EVMs, TI attempts to be as accurate as possible. However, TI does not warrant the accuracy of EVM descriptions, EVM availability or other information on its websites as accurate, complete, reliable, current, or error-free.
 6. *Disclaimers:*
 - 6.1 EXCEPT AS SET FORTH ABOVE, EVMS AND ANY MATERIALS PROVIDED WITH THE EVM (INCLUDING, BUT NOT LIMITED TO, REFERENCE DESIGNS AND THE DESIGN OF THE EVM ITSELF) ARE PROVIDED "AS IS" AND "WITH ALL FAULTS." TI DISCLAIMS ALL OTHER WARRANTIES, EXPRESS OR IMPLIED, REGARDING SUCH ITEMS, INCLUDING BUT NOT LIMITED TO ANY EPIDEMIC FAILURE WARRANTY OR IMPLIED WARRANTIES OF MERCHANTABILITY OR FITNESS FOR A PARTICULAR PURPOSE OR NON-INFRINGEMENT OF ANY THIRD PARTY PATENTS, COPYRIGHTS, TRADE SECRETS OR OTHER INTELLECTUAL PROPERTY RIGHTS.
 - 6.2 EXCEPT FOR THE LIMITED RIGHT TO USE THE EVM SET FORTH HEREIN, NOTHING IN THESE TERMS SHALL BE CONSTRUED AS GRANTING OR CONFERRING ANY RIGHTS BY LICENSE, PATENT, OR ANY OTHER INDUSTRIAL OR INTELLECTUAL PROPERTY RIGHT OF TI, ITS SUPPLIERS/LICENSORS OR ANY OTHER THIRD PARTY, TO USE THE EVM IN ANY FINISHED END-USER OR READY-TO-USE FINAL PRODUCT, OR FOR ANY INVENTION, DISCOVERY OR IMPROVEMENT, REGARDLESS OF WHEN MADE, CONCEIVED OR ACQUIRED.
 7. *USER'S INDEMNITY OBLIGATIONS AND REPRESENTATIONS.* USER WILL DEFEND, INDEMNIFY AND HOLD TI, ITS LICENSORS AND THEIR REPRESENTATIVES HARMLESS FROM AND AGAINST ANY AND ALL CLAIMS, DAMAGES, LOSSES, EXPENSES, COSTS AND LIABILITIES (COLLECTIVELY, "CLAIMS") ARISING OUT OF OR IN CONNECTION WITH ANY HANDLING OR USE OF THE EVM THAT IS NOT IN ACCORDANCE WITH THESE TERMS. THIS OBLIGATION SHALL APPLY WHETHER CLAIMS ARISE UNDER STATUTE, REGULATION, OR THE LAW OF TORT, CONTRACT OR ANY OTHER LEGAL THEORY, AND EVEN IF THE EVM FAILS TO PERFORM AS DESCRIBED OR EXPECTED.

8. *Limitations on Damages and Liability:*

8.1 *General Limitations.* IN NO EVENT SHALL TI BE LIABLE FOR ANY SPECIAL, COLLATERAL, INDIRECT, PUNITIVE, INCIDENTAL, CONSEQUENTIAL, OR EXEMPLARY DAMAGES IN CONNECTION WITH OR ARISING OUT OF THESE TERMS OR THE USE OF THE EVMS , REGARDLESS OF WHETHER TI HAS BEEN ADVISED OF THE POSSIBILITY OF SUCH DAMAGES. EXCLUDED DAMAGES INCLUDE, BUT ARE NOT LIMITED TO, COST OF REMOVAL OR REINSTALLATION, ANCILLARY COSTS TO THE PROCUREMENT OF SUBSTITUTE GOODS OR SERVICES, RETESTING, OUTSIDE COMPUTER TIME, LABOR COSTS, LOSS OF GOODWILL, LOSS OF PROFITS, LOSS OF SAVINGS, LOSS OF USE, LOSS OF DATA, OR BUSINESS INTERRUPTION. NO CLAIM, SUIT OR ACTION SHALL BE BROUGHT AGAINST TI MORE THAN TWELVE (12) MONTHS AFTER THE EVENT THAT GAVE RISE TO THE CAUSE OF ACTION HAS OCCURRED.

8.2 *Specific Limitations.* IN NO EVENT SHALL TI'S AGGREGATE LIABILITY FROM ANY USE OF AN EVM PROVIDED HEREUNDER, INCLUDING FROM ANY WARRANTY, INDEMNITY OR OTHER OBLIGATION ARISING OUT OF OR IN CONNECTION WITH THESE TERMS, , EXCEED THE TOTAL AMOUNT PAID TO TI BY USER FOR THE PARTICULAR EVM(S) AT ISSUE DURING THE PRIOR TWELVE (12) MONTHS WITH RESPECT TO WHICH LOSSES OR DAMAGES ARE CLAIMED. THE EXISTENCE OF MORE THAN ONE CLAIM SHALL NOT ENLARGE OR EXTEND THIS LIMIT.

9. *Return Policy.* Except as otherwise provided, TI does not offer any refunds, returns, or exchanges. Furthermore, no return of EVM(s) will be accepted if the package has been opened and no return of the EVM(s) will be accepted if they are damaged or otherwise not in a resalable condition. If User feels it has been incorrectly charged for the EVM(s) it ordered or that delivery violates the applicable order, User should contact TI. All refunds will be made in full within thirty (30) working days from the return of the components(s), excluding any postage or packaging costs.

10. *Governing Law:* These terms and conditions shall be governed by and interpreted in accordance with the laws of the State of Texas, without reference to conflict-of-laws principles. User agrees that non-exclusive jurisdiction for any dispute arising out of or relating to these terms and conditions lies within courts located in the State of Texas and consents to venue in Dallas County, Texas. Notwithstanding the foregoing, any judgment may be enforced in any United States or foreign court, and TI may seek injunctive relief in any United States or foreign court.

Mailing Address: Texas Instruments, Post Office Box 655303, Dallas, Texas 75265
Copyright © 2023, Texas Instruments Incorporated

IMPORTANT NOTICE AND DISCLAIMER

TI PROVIDES TECHNICAL AND RELIABILITY DATA (INCLUDING DATASHEETS), DESIGN RESOURCES (INCLUDING REFERENCE DESIGNS), APPLICATION OR OTHER DESIGN ADVICE, WEB TOOLS, SAFETY INFORMATION, AND OTHER RESOURCES "AS IS" AND WITH ALL FAULTS, AND DISCLAIMS ALL WARRANTIES, EXPRESS AND IMPLIED, INCLUDING WITHOUT LIMITATION ANY IMPLIED WARRANTIES OF MERCHANTABILITY, FITNESS FOR A PARTICULAR PURPOSE OR NON-INFRINGEMENT OF THIRD PARTY INTELLECTUAL PROPERTY RIGHTS.

These resources are intended for skilled developers designing with TI products. You are solely responsible for (1) selecting the appropriate TI products for your application, (2) designing, validating and testing your application, and (3) ensuring your application meets applicable standards, and any other safety, security, regulatory or other requirements.

These resources are subject to change without notice. TI grants you permission to use these resources only for development of an application that uses the TI products described in the resource. Other reproduction and display of these resources is prohibited. No license is granted to any other TI intellectual property right or to any third party intellectual property right. TI disclaims responsibility for, and you fully indemnify TI and its representatives against any claims, damages, costs, losses, and liabilities arising out of your use of these resources.

TI's products are provided subject to [TI's Terms of Sale](#), [TI's General Quality Guidelines](#), or other applicable terms available either on ti.com or provided in conjunction with such TI products. TI's provision of these resources does not expand or otherwise alter TI's applicable warranties or warranty disclaimers for TI products. Unless TI explicitly designates a product as custom or customer-specified, TI products are standard, catalog, general purpose devices.

TI objects to and rejects any additional or different terms you may propose.

Copyright © 2026, Texas Instruments Incorporated

Last updated 10/2025