



ABSTRACT

This report covers the radiation characterization results of the SN54SC8T157-SEP, radiation tolerant quadruple 2-line to 1-line data selectors/multiplexers. The study was done to determine Total Ionizing Dose (TID) effects under high dose rate (HDR) to 30krad(Si). Radiation Lot Acceptance Testing (RLAT) will be performed using five units at a dose level of 30krad(Si) per MIL-STD-883 TM 1019. All future wafer lots will be tested under the same conditions. The device is manufactured in pure CMOS process. HDR TID response is the worst case. TID HDR characterization was performed per TM 1019.

The SN54SC8T157-SEP is packaged in a space enhanced plastic package for low outgassing characteristics and is Single Event Latch-Up (SEL) immune up to 50MeV-cm²/mg, which makes the device an option for low Earth orbit space applications. Single Event Transient (SET) data is also provided in the Single Event Effects Radiation Report.

For full total ionizing dose characterization results, see [SN54SC8T138-SEP Total Ionizing Dose \(TID\) Report](#).

Table of Contents

1 Device Information	2
1.1 Device Details.....	2
2 Total Dose Test Setup	3
2.1 Test Overview.....	3
2.2 Test Description and Facilities.....	3
2.3 Test Setup Details.....	3
2.4 Test Configuration and Condition.....	4
3 TID Characterization Test Results	5
3.1 TID Characterization Summary Results.....	5
3.2 Specification Compliance Matrix.....	6
4 Reference Documents	7
5 Appendix: HDR TID Report Data	7

List of Figures

Figure 2-1. SN54SC8T157-SEP Bias Diagram.....	3
---	---

List of Tables

Table 1-1. Device and Exposure Details.....	2
Table 2-1. HDR Device Information.....	4
Table 3-1. Electrical Parameters Table.....	6

Trademarks

All trademarks are the property of their respective owners.

1 Device Information

The SN54SC8T157-SEP contains four data selectors/multiplexers to select one of two data sources. All channels are controlled by the same address select (\bar{A}/B) input, and strobe (\bar{G}) input. A high level at the strobe terminal forces all outputs low.

1.1 Device Details

Table 1-1 lists the device information used for TID HDR characterization and qualification.

Table 1-1. Device and Exposure Details

TID HDR Details: Up To 30krad(Si)	
TI Device Number	SN54SC8T157-SEP
VID Number	V62/25624
Package	16-pin PW (TSSOP)
Technology	LBC9
Die Lot Number	3282528RFB
A/T Lot Number and Date Code	4165164ML4 / 42CC69K
Quantity Tested	6 irradiated devices + 4 control
Lot Accept or Reject	Devices passed 30krad(Si)
HDR Radiation Facility	Texas Instruments CLAB in Dallas, Texas
HDR Dose Level	30krad(Si)
HDR Dose Rate	174.54rad(Si)/s ionizing radiation
Effective Dose Rate 30krad(Si) with 72 hour Anneal	115.74mrad(Si)/s ionizing radiation
HDR Radiation Source	Gammacell 220 Excel (GC-220E) Co-60
Irradiation Temperature	Ambient, room temperature

2 Total Dose Test Setup

2.1 Test Overview

The SN54SC8T157-SEP samples were irradiated at a high dose rate of 174.54rad(Si)/s up to 30krad(Si) (115.74mrad(Si)/s effective does rate for 30krad(Si) with 72 hour anneal) and then put through full electrical parametric testing on the production Automated Test Equipment (ATE). The samples were functional and passed all electrical parametric tests with readings within data sheet electrical specification limits.

2.2 Test Description and Facilities

The SN54SC8T157-SEP HDR exposure was performed on biased devices in a Co-60 gamma cell at TI facility in Dallas, Texas. The un-attenuated dose rate of this cell is 174.54rads(Si)/s (115.74mrad(Si)/s effective does rate of 30krad(Si) with 72 hour anneal). After exposure, the devices were packed in dry ice (per MIL-STD-883 Method 1019.9 section 3.10) and full post radiation electrical evaluation using Texas Instruments ATE was conducted. ATE test limits are set per data sheet electrical limits based on qualification and characterization data. Post radiation measurements were taken within 30 minutes of removing the devices from the dry ice container. The devices were allowed to reach room temperature prior to electrical post radiation measurements.

2.3 Test Setup Details

The devices were tested in biased conditions as described in the following sections.

2.3.1 Bias Diagram

Figure 2-1 shows the bias conditions for each pin during irradiation.

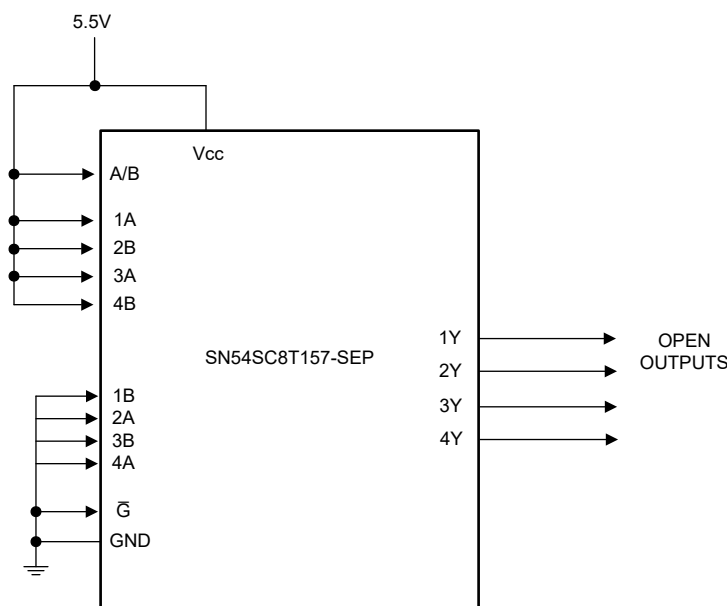

Figure 2-1. SN54SC8T157-SEP Bias Diagram

2.4 Test Configuration and Condition

The HDR RLAT units were irradiated to 30krad(Si), parametrically tested on ATE, and then were annealed at 25°C for 72 hours. The units that were irradiated to 30krad(Si) and were annealed for 72 hours are denoted as 31krad(Si) in [Section 5](#). ATE parametric testing was completed before and after the anneal.

[Table 2-1](#) lists the serialized samples used for TID characterization.

Table 2-1. HDR Device Information

Control Group	HDR Dose Rate = 174.54rad(Si)/s Effective Dose Rate (30krad + Anneal 72 hours) = 115.74mrad(Si)/s	
Total Samples: 4	Total Samples: 6 Biased	
	Exposure Levels	
0krad (Si)	30krad(Si)	
Biased	Biased	Biased + 72 hour anneal
1 - 4	5 - 10	5a - 10a

3 TID Characterization Test Results

3.1 TID Characterization Summary Results

The parametric data for the SN54SC8T157-SEP passes up to 30krad(Si) (with 72 hour room temperature anneal) HDR TID irradiation. The drifts of the electrical parameters through HDR were within the data sheet limits.

Overall, the SN54SC8T157-SEP showed a strong degree of hardness to HDR TID irradiation up to 30krad(Si). The measurements taken post-irradiation for each sample set showed a marginal shift for most parameters at each dose level. The parameters that did show a greater degree of change between pre- and post-irradiation were still within the electrical performance characteristics specified in the data sheet electrical parameters. For the data sheet electrical parameters and associated tests, see [SN54SC8T157-SEP Radiation-Tolerant, Quadruple 2-Line to 1-Line Data Selectors/Multiplexers](#).

See [Section 5](#) for HDR report up to 30 krad(Si).

3.2 Specification Compliance Matrix

Table 3-1. Electrical Parameters Table

Parameter	Test Conditions	V _{CC}	T _A = -55°C to +125°C			Unit	Test Name
			MIN	TYP	MAX		
V _{T+} 1	Positive-going input threshold voltage	1.2V to 1.3V	0.31	0.655	1.1	V	VTP_1P2V
		1.65V to 2V	0.39	0.915	1.32		VTP_1P65V
		2.25V to 2.75V	0.51	1.09	1.51		VTP_2P25V
		3V to 3.6V	0.65	1.2	1.7		VTP_3V
		4.5V to 5.5V	0.87	1.51	2.16		VTP_4P5V, VTP_5P5V
V _{T-} 1	Negative-going input threshold voltage	1.2V to 1.3V	0.11	0.349	0.60	V	VTN_1P2V
		1.65V to 2V	0.18	0.455	0.63		VTN_1P65V
		2.25V to 2.75V	0.25	0.545	0.74		VTN_2P25V
		3V to 3.6V	0.33	0.635	0.85		VTN_3V
		4.5V to 5.5V	0.45	0.755	1.14		VTN_4P5V, VTN_5P5V
ΔV _T 1	Hysteresis (V _{T+} - V _{T-})	1.2V to 1.3V	0.2	0.29	0.77	V	DELTAVT_1P2V
		1.65V to 2V	0.21	0.43	0.88		DELTAVT_1P65V
		2.25V to 2.75V	0.25	0.54	0.91		DELTAVT_2P25V
		3V to 3.6V	0.31	0.63	0.91		DELTAVT_3V
		4.5V to 5.5V	0.43	0.75	1.05		DELTAVT_4P5V, DELTAVT_5P5V
V _{IH}	High-level input voltage	1.2V to 1.3V	0.78			V	VIH_1P2V
		1.65V to 2V	1.1				VIH_1P65V
		2.25V to 2.75V	1.28				VIH_2P25V
		3V to 3.6V	1.45				VIH_3V
		4.5V to 5.5V	2				VIH_4P5V, VIH_5P5V
V _{IL}	Low-Level input voltage	1.2V to 1.3V			0.18	V	VIL_1P2V
		1.65V to 2V			0.5		VIL_1P65V
		2.25V to 2.75V			0.65		VIL_2P25V
		3V to 3.6V			0.75		VIL_3V
		4.5V to 5.5V			0.85		VIL_4P5V, VIL_5P5V
V _{OH} 2	I _{OH} = -50μA	1.2V to 5.5V	V _{CC} -0.2			V	VOH_N50UA_1P2V, VOH_N50UA_5P5V
	I _{OH} = -1mA	1.2V	0.8				VOH_N1MA_1P2V
	I _{OH} = -2mA	1.65V to 2V	1.21				VOH_N2MA_1P65V
	I _{OH} = -3mA	2.25V to 2.75V	1.93				VOH_N3MA_2P25V
	I _{OH} = -5.5mA	3V to 3.6V	2.49				VOH_N5P5MA_3V
	I _{OH} = -8mA	4.5V to 5.5V	3.95				VOH_N8MA_4P5V
	I _{OH} = -24mA	4.5V to 5.5V	3.15				VOH_N24MA_5P5V
V _{OL}	I _{OL} = 50μA	1.2V to 5.5V			0.1	V	VOL_50UA_1P2V, VOL_50UA_5P5V
	I _{OL} = 1mA	1.2V			0.2		VOL_1MA_1P2V
	I _{OL} = 2mA	1.65V to 2V			0.25		VOL_2MA_1P65V
	I _{OL} = 3mA	2.25V to 2.75V			0.2		VOL_3MA_2P25V
	I _{OL} = 5.5mA	3V to 3.6V			0.25		VOL_5P5MA_3V
	I _{OL} = 8mA	4.5V to 5.5V			0.35		VOL_8MA_4P5V
	I _{OL} = 24mA	4.5V to 5.5V			0.75		VOL_24MA_5P5V
I _{CC}	V _I = V _{CC} or GND, I _O = 0	1.2V to 5.5V		2	220	μA	ICC_5P5V
ΔI _{CC}	One input at 0.3V or 3.4V, other inputs at V _{CC} or GND	5.5V			1.5	mA	DELTAICC_5P5V
	One input at 0.3V or 1.1V, other inputs at V _{CC} or GND	1.8V			68	μA	DELTAICC_1P8V
I _{OZ} 3	V _O = V _{CC} or GND	5.5V			±26	μA	IOZ_5P5V
I _I	V _I = 0V to V _{CC}	V _I = 0V to V _{CC}			±1	μA	II_5P5V

- Schmitt-trigger input devices only.
- Push-pull output devices only.
- 3-State output devices only.

4 Reference Documents

Texas Instruments total ionizing dose radiation (total dose) test procedure follows the standards put forth in MIL-STD-883 TM 1019. The document can be found at the DLA website.

5 Appendix: HDR TID Report Data

This appendix provides the SN54SC8T157-SEP TID HDR report. The report shows the variation for each parameter up to 30krad(Si).

TID Report

SN54SC8T157-SEP

DELTAICC_1P8V						
Units	μA					
Max Limit	68					
Min Limit	-1					
krad	Serial #	PreTestHDR	PostTestHDR	Delta	Delta %	% of Limit Range
0	1	2.879	3.098	0.22	7.61%	0.32%
0	2	2.817	2.629	-0.19	-6.67%	0.27%
0	3	2.629	2.785	0.16	5.93%	0.23%
0	4	3.317	3.067	-0.25	-7.54%	0.36%
30	5	2.879	2.629	-0.25	-8.68%	0.36%
30	6	2.817	2.535	-0.28	-10.01%	0.41%
30	7	3.130	3.224	0.09	3.00%	0.14%
30	8	2.848	2.911	0.06	2.21%	0.09%
30	9	2.785	2.879	0.09	3.38%	0.14%
30	10	2.723	2.973	0.25	9.18%	0.36%
31	5a	2.879	2.879	0.00	0.00%	0.00%
31	6a	2.817	2.660	-0.16	-5.57%	0.23%
31	7a	3.130	2.817	-0.31	-10.00%	0.45%
31	8a	2.848	2.848	0.00	0.00%	0.00%
31	9a	2.785	2.879	0.09	3.38%	0.14%
31	10a	2.723	2.692	-0.03	-1.14%	0.04%
Max	3.317	3.224	-0.09	9.18%	0.45%	
Average	2.875	2.844	-0.03	-0.93%	0.22%	
Min	2.629	2.535	-0.09	-10.01%	0.00%	
Std Dev	0.175	0.188	0.01	6.37%	0.15%	

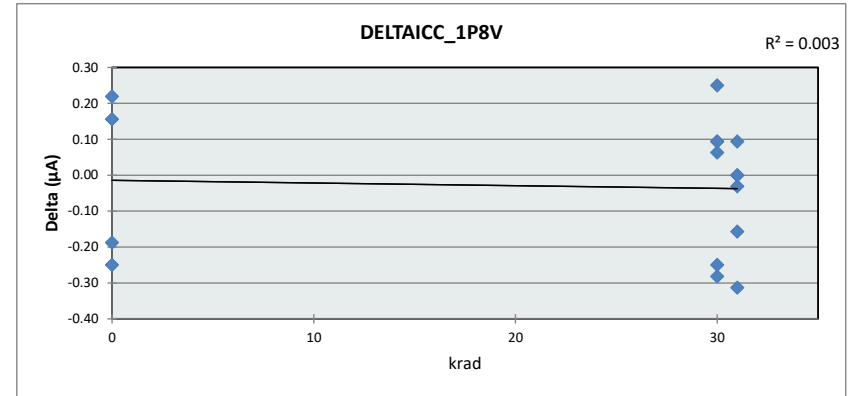

DELTAICC_1P8V			
Units	μA		
Max Limit	68		
Min Limit	-1		
krad	0	30	31
LL	-1.000	-1.000	-1.000
Min	2.629	2.535	2.660
Average	2.895	2.859	2.796
Max	3.098	3.224	2.879
UL	68.000	68.000	68.000

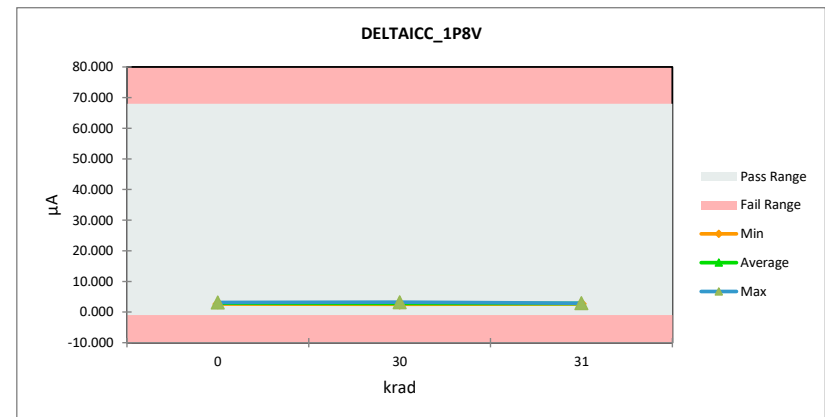

TID Report

SN54SC8T157-SEP

DELTAICC_5P5V						
Units	μA					
Max Limit	1500					
Min Limit	-1					
krad	Serial #	PreTestHDR	PostTestHDR	Delta	Delta %	% of Limit Range
0	1	90.070	90.260	0.19	0.21%	0.01%
0	2	90.730	91.200	0.47	0.52%	0.03%
0	3	90.170	90.480	0.31	0.34%	0.02%
0	4	90.480	90.610	0.13	0.14%	0.01%
30	5	90.640	91.320	0.68	0.75%	0.05%
30	6	90.700	90.920	0.22	0.24%	0.01%
30	7	90.700	90.670	-0.03	-0.03%	0.00%
30	8	90.350	91.670	1.32	1.46%	0.09%
30	9	90.230	90.350	0.12	0.13%	0.01%
30	10	90.170	90.170	0.00	0.00%	0.00%
31	5a	90.640	88.790	-1.85	-2.04%	0.12%
31	6a	90.700	88.880	-1.82	-2.01%	0.12%
31	7a	90.700	89.130	-1.57	-1.73%	0.10%
31	8a	90.350	89.320	-1.03	-1.14%	0.07%
31	9a	90.230	88.730	-1.50	-1.66%	0.10%
31	10a	90.170	88.920	-1.25	-1.39%	0.08%
Max	90.730	91.670	0.94	1.46%	0.12%	
Average	90.439	90.089	-0.35	-0.39%	0.05%	
Min	90.070	88.730	-1.34	-2.04%	0.00%	
Std Dev	0.244	0.989	0.74	1.10%	0.05%	

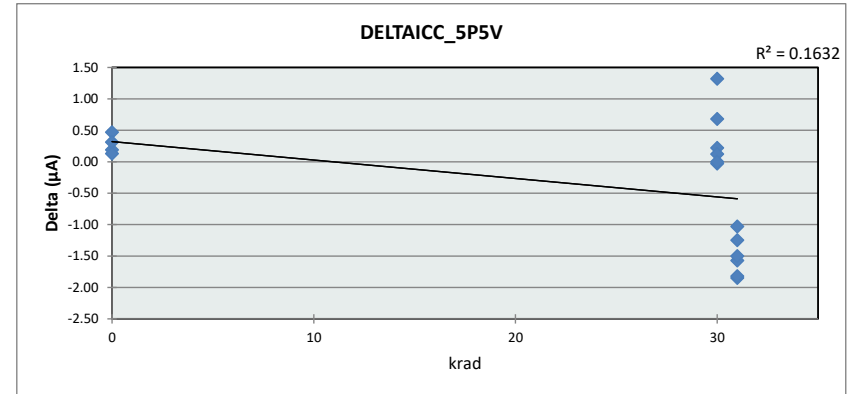

DELTAICC_5P5V			
Units	μA		
Max Limit	1500		
Min Limit	-1		
krad	0	30	31
LL	-1.000	-1.000	-1.000
Min	90.260	90.170	88.730
Average	90.638	90.850	88.962
Max	91.200	91.670	89.320
UL	1500.000	1500.000	1500.000

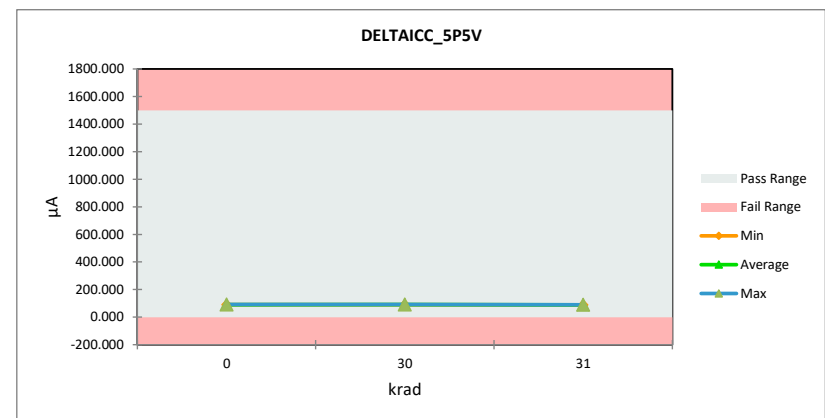

TID Report

SN54SC8T157-SEP

ICC						
Units	μA					
Max Limit	220					
Min Limit	-0.1					
krad	Serial #	PreTestHDR	PostTestHDR	Delta	Delta %	% of Limit Range
0	1	0.092	0.044	-0.05	-52.49%	0.02%
0	2	0.075	0.035	-0.04	-53.47%	0.02%
0	3	0.082	0.038	-0.04	-53.35%	0.02%
0	4	0.040	0.042	0.00	5.54%	0.00%
30	5	0.106	373.900	373.79	353636.99%	169.83%
30	6	0.076	365.300	365.22	481381.48%	165.94%
30	7	0.071	342.000	341.93	480507.08%	155.35%
30	8	0.066	402.100	402.03	613793.13%	182.66%
30	9	0.104	327.600	327.50	314295.39%	148.79%
30	10	0.100	338.700	338.60	338261.64%	153.84%
31	5a	0.106	47.090	46.98	44450.61%	21.35%
31	6a	0.076	29.560	29.48	38861.38%	13.40%
31	7a	0.071	41.150	41.08	57727.43%	18.66%
31	8a	0.066	38.410	38.34	58541.22%	17.42%
31	9a	0.104	40.020	39.92	38306.91%	18.14%
31	10a	0.100	42.610	42.51	42467.43%	19.31%
Max		0.106	402.100	401.99	613793.13%	182.66%
Average		0.083	149.287	149.20	178879.81%	67.80%
Min		0.040	0.035	0.00	-53.47%	0.00%
Std Dev		0.019	168.725	168.71	212785.90%	76.65%

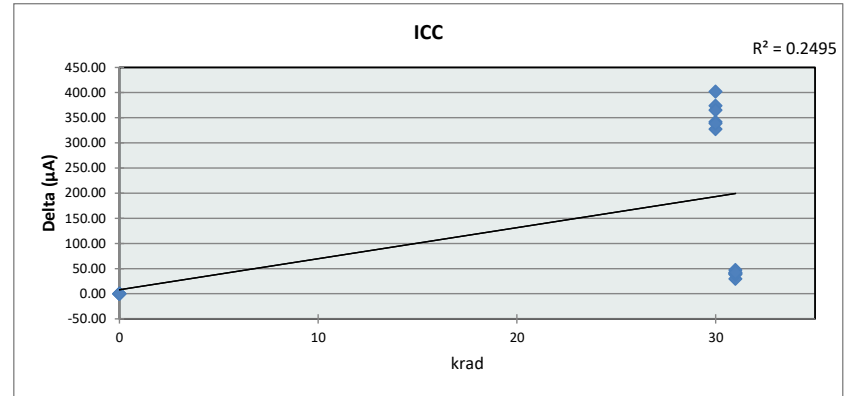

ICC			
Units	μA		
Max Limit	220		
Min Limit	-0.1		
krad	0	30	31
LL	-0.100	-0.100	-0.100
Min	0.035	327.600	29.560
Average	0.040	358.267	39.807
Max	0.044	402.100	47.090
UL	220.000	220.000	220.000

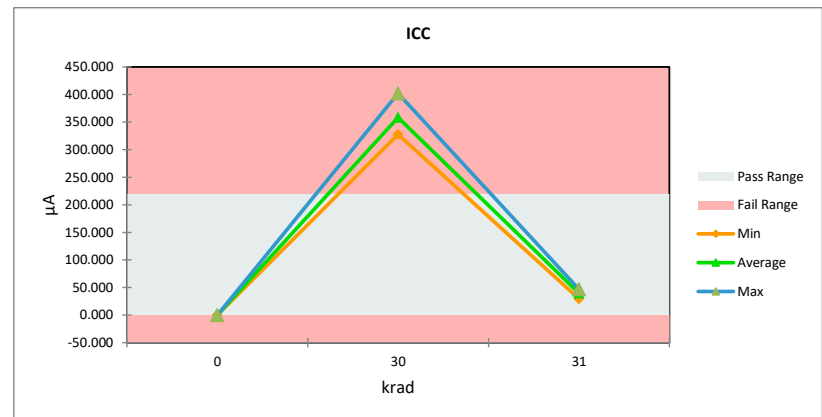

TID Report

SN54SC8T157-SEP

II_5P5V						
Units	μA					
Max Limit	1					
Min Limit	-1					
krad	Serial #	PreTestHDR	PostTestHDR	Delta	Delta %	% of Limit Range
0	1	0.110	0.027	-0.08	-75.82%	4.16%
0	2	0.075	0.013	-0.06	-82.94%	3.09%
0	3	0.065	0.012	-0.05	-80.93%	2.61%
0	4	0.013	0.027	0.01	108.86%	0.70%
30	5	0.055	0.009	-0.05	-83.97%	2.29%
30	6	0.058	0.006	-0.05	-90.35%	2.62%
30	7	0.074	0.017	-0.06	-76.77%	2.85%
30	8	0.056	0.009	-0.05	-84.86%	2.39%
30	9	0.086	0.008	-0.08	-91.04%	3.91%
30	10	0.068	0.011	-0.06	-84.06%	2.86%
31	5a	0.055	0.013	-0.04	-76.46%	2.08%
31	6a	0.058	0.022	-0.04	-61.40%	1.78%
31	7a	0.074	0.023	-0.05	-68.92%	2.56%
31	8a	0.056	0.013	-0.04	-77.62%	2.19%
31	9a	0.086	0.014	-0.07	-84.09%	3.61%
31	10a	0.068	0.014	-0.05	-79.02%	2.69%
Max		0.110	0.027	-0.08	108.86%	4.16%
Average		0.066	0.015	-0.05	-68.09%	2.65%
Min		0.013	0.006	-0.01	-91.04%	0.70%
Std Dev		0.021	0.007	-0.01	47.77%	0.83%

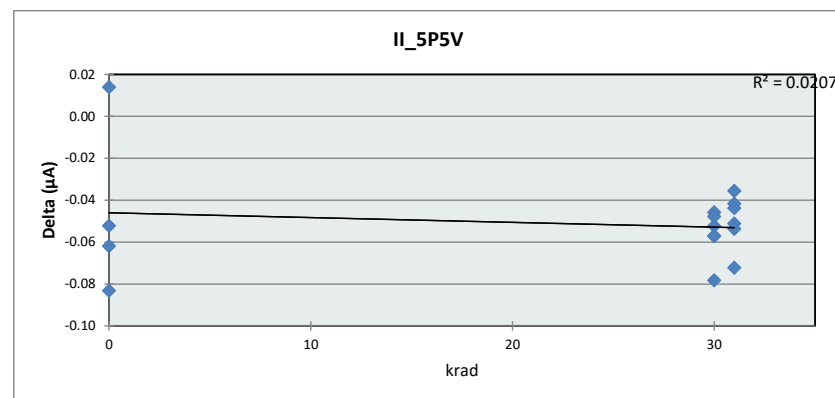

II_5P5V			
Units	μA		
Max Limit	1		
Min Limit	-1		
krad	0	30	31
LL	-1.000	-1.000	-1.000
Min	0.012	0.006	0.013
Average	0.020	0.010	0.016
Max	0.027	0.017	0.023
UL	1.000	1.000	1.000

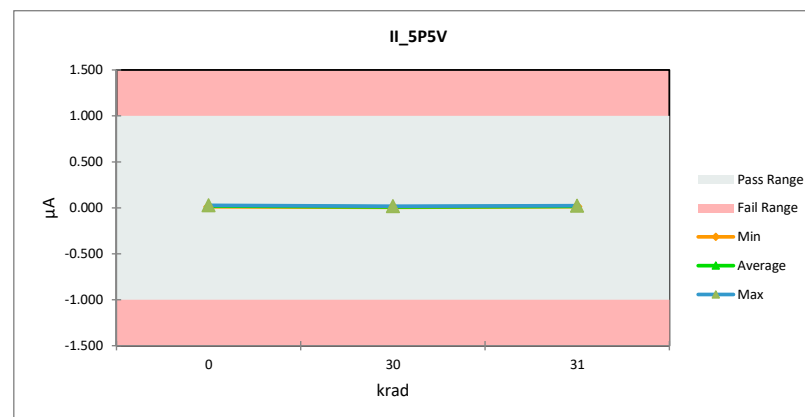

TID Report

SN54SC8T157-SEP

VIH_1P2V						
Units	V					
Max Limit	0.78					
Min Limit	0.18					
krad	Serial #	PreTestHDR	PostTestHDR	Delta	Delta %	% of Limit Range
0	1	0.547	0.547	0.00	0.00%	0.00%
0	2	0.554	0.554	0.00	0.11%	0.10%
0	3	0.546	0.547	0.00	0.11%	0.10%
0	4	0.557	0.557	0.00	0.00%	0.00%
30	5	0.548	0.102	-0.45	-81.29%	74.19%
30	6	0.555	0.220	-0.34	-60.38%	55.89%
30	7	0.549	0.103	-0.45	-81.22%	74.29%
30	8	0.554	0.104	-0.45	-81.28%	74.99%
30	9	0.549	0.117	-0.43	-78.68%	71.96%
30	10	0.549	0.105	-0.44	-80.91%	74.09%
31	5a	0.548	0.353	-0.19	-35.55%	32.44%
31	6a	0.555	0.390	-0.17	-29.81%	27.59%
31	7a	0.549	0.369	-0.18	-32.82%	30.02%
31	8a	0.554	0.407	-0.15	-26.51%	24.46%
31	9a	0.549	0.351	-0.20	-36.03%	32.95%
31	10a	0.549	0.342	-0.21	-37.75%	34.57%
Max	0.557	0.557	0.00	0.11%	74.99%	
Average	0.551	0.323	-0.23	-41.38%	37.98%	
Min	0.546	0.102	-0.44	-81.29%	0.00%	
Std Dev	0.003	0.177	0.17	32.10%	29.39%	

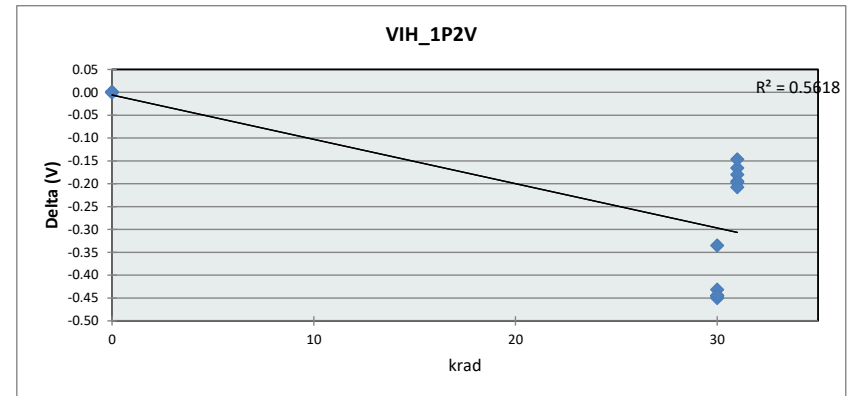

VIH_1P2V			
Units	V		
Max Limit	0.78		
Min Limit	0.18		
krad	0	30	31
LL	0.180	0.180	0.180
Min	0.547	0.102	0.342
Average	0.551	0.125	0.369
Max	0.557	0.220	0.407
UL	0.780	0.780	0.780

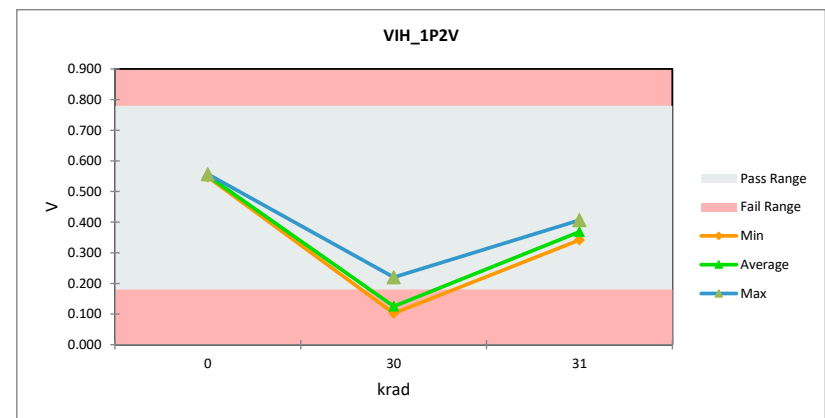

TID Report

SN54SC8T157-SEP

VIH_1P65V						
Units	V					
Max Limit	1.1					
Min Limit	0.5					
krad	Serial #	PreTestHDR	PostTestHDR	Delta	Delta %	% of Limit Range
0	1	0.712	0.712	0.00	0.00%	0.00%
0	2	0.720	0.720	0.00	0.00%	0.00%
0	3	0.712	0.712	0.00	0.00%	0.00%
0	4	0.723	0.723	0.00	0.12%	0.15%
30	5	0.713	0.528	-0.18	-25.90%	30.78%
30	6	0.721	0.519	-0.20	-27.94%	33.56%
30	7	0.713	0.524	-0.19	-26.52%	31.51%
30	8	0.720	0.517	-0.20	-28.21%	33.85%
30	9	0.713	0.525	-0.19	-26.40%	31.36%
30	10	0.715	0.532	-0.18	-25.59%	30.48%
31	5a	0.713	0.631	-0.08	-11.47%	13.63%
31	6a	0.721	0.650	-0.07	-9.76%	11.72%
31	7a	0.713	0.628	-0.08	-11.84%	14.07%
31	8a	0.720	0.654	-0.07	-9.16%	10.99%
31	9a	0.713	0.629	-0.08	-11.72%	13.92%
31	10a	0.715	0.635	-0.08	-11.20%	13.34%
Max	0.723	0.723	0.00	0.12%	33.85%	
Average	0.716	0.615	-0.10	-14.10%	16.84%	
Min	0.712	0.517	-0.20	-28.21%	0.00%	
Std Dev	0.004	0.080	0.08	11.06%	13.18%	

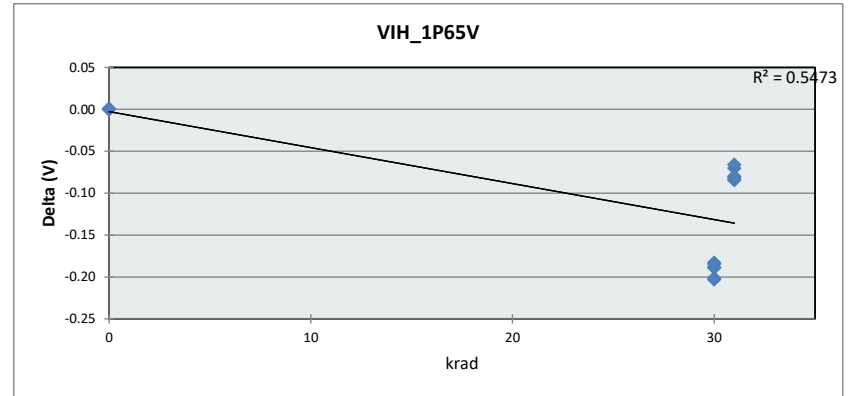

VIH_1P65V			
Units	V		
Max Limit	1.1		
Min Limit	0.5		
krad	0	30	31
LL	0.500	0.500	0.500
Min	0.712	0.517	0.628
Average	0.717	0.524	0.638
Max	0.723	0.532	0.654
UL	1.100	1.100	1.100

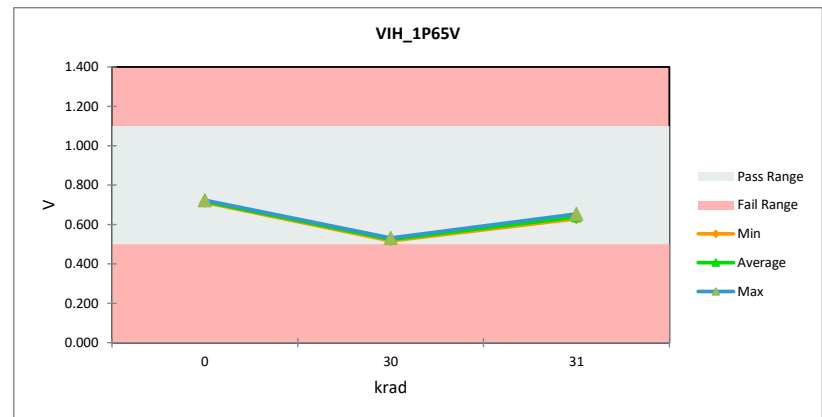

TID Report

SN54SC8T157-SEP

VIH_2P25V						
Units	V					
Max Limit	1.28					
Min Limit	0.65					
krad	Serial #	PreTestHDR	PostTestHDR	Delta	Delta %	% of Limit Range
0	1	0.884	0.884	0.00	0.00%	0.00%
0	2	0.889	0.889	0.00	0.00%	0.00%
0	3	0.884	0.884	0.00	0.00%	0.00%
0	4	0.894	0.894	0.00	0.00%	0.00%
30	5	0.883	0.774	-0.11	-12.39%	17.37%
30	6	0.892	0.787	-0.10	-11.71%	16.58%
30	7	0.882	0.778	-0.10	-11.84%	16.58%
30	8	0.891	0.784	-0.11	-12.00%	16.97%
30	9	0.884	0.781	-0.10	-11.67%	16.38%
30	10	0.882	0.785	-0.10	-10.99%	15.39%
31	5a	0.883	0.827	-0.06	-6.33%	8.88%
31	6a	0.892	0.843	-0.05	-5.44%	7.70%
31	7a	0.882	0.825	-0.06	-6.48%	9.08%
31	8a	0.891	0.845	-0.05	-5.16%	7.30%
31	9a	0.884	0.832	-0.05	-5.90%	8.29%
31	10a	0.882	0.829	-0.05	-6.06%	8.49%
	Max	0.894	0.894	0.00	0.00%	17.37%
	Average	0.886	0.828	-0.06	-6.62%	9.31%
	Min	0.882	0.774	-0.11	-12.39%	0.00%
	Std Dev	0.004	0.043	0.04	4.76%	6.69%

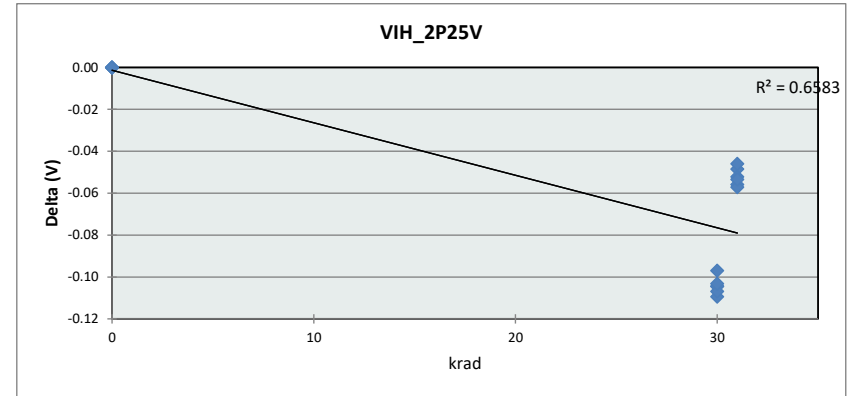

VIH_2P25V			
Units	V		
Max Limit	1.28		
Min Limit	0.65		
krad	0	30	31
LL	0.650	0.650	0.650
Min	0.884	0.774	0.825
Average	0.888	0.781	0.833
Max	0.894	0.787	0.845
UL	1.280	1.280	1.280

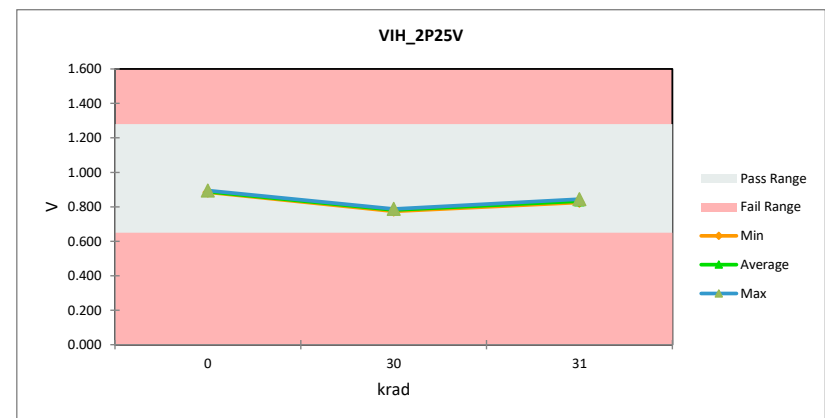

TID Report

SN54SC8T157-SEP

VIH_3V						
Units	V					
Max Limit	1.45					
Min Limit	0.75					
krad	Serial #	PreTestHDR	PostTestHDR	Delta	Delta %	% of Limit Range
0	1	1.066	1.068	0.00	0.16%	0.24%
0	2	1.073	1.076	0.00	0.32%	0.49%
0	3	1.068	1.070	0.00	0.16%	0.24%
0	4	1.078	1.078	0.00	0.00%	0.00%
30	5	1.070	0.995	-0.07	-6.99%	10.67%
30	6	1.075	1.003	-0.07	-6.64%	10.19%
30	7	1.066	0.995	-0.07	-6.69%	10.19%
30	8	1.078	0.998	-0.08	-7.40%	11.40%
30	9	1.068	0.995	-0.07	-6.84%	10.43%
30	10	1.064	0.991	-0.07	-6.86%	10.43%
31	5a	1.070	1.031	-0.04	-3.65%	5.58%
31	6a	1.075	1.041	-0.03	-3.16%	4.85%
31	7a	1.066	1.034	-0.03	-3.03%	4.61%
31	8a	1.078	1.044	-0.03	-3.15%	4.85%
31	9a	1.068	1.027	-0.04	-3.82%	5.82%
31	10a	1.064	1.027	-0.04	-3.51%	5.34%
Max	1.078	1.078	0.00	0.32%	11.40%	
Average	1.070	1.030	-0.04	-3.82%	5.96%	
Min	1.064	0.991	-0.07	-7.40%	0.00%	
Std Dev	0.005	0.031	0.03	2.86%	4.19%	

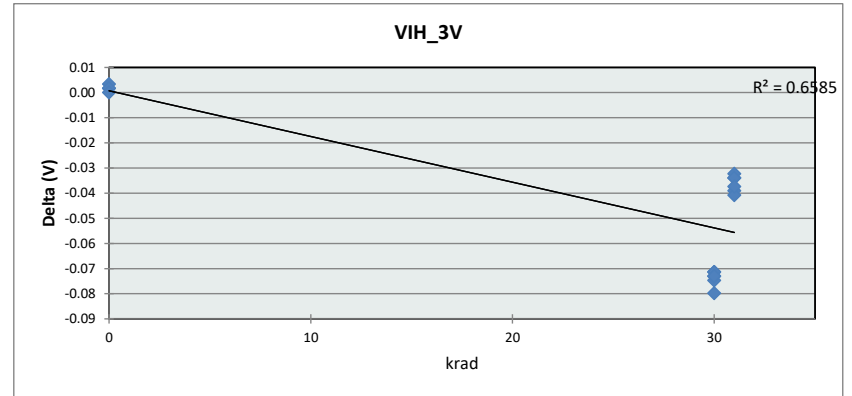

VIH_3V			
Units	V		
Max Limit	1.45		
Min Limit	0.75		
krad	0	30	31
LL	0.750	0.750	0.750
Min	1.068	0.991	1.027
Average	1.073	0.996	1.034
Max	1.078	1.003	1.044
UL	1.450	1.450	1.450

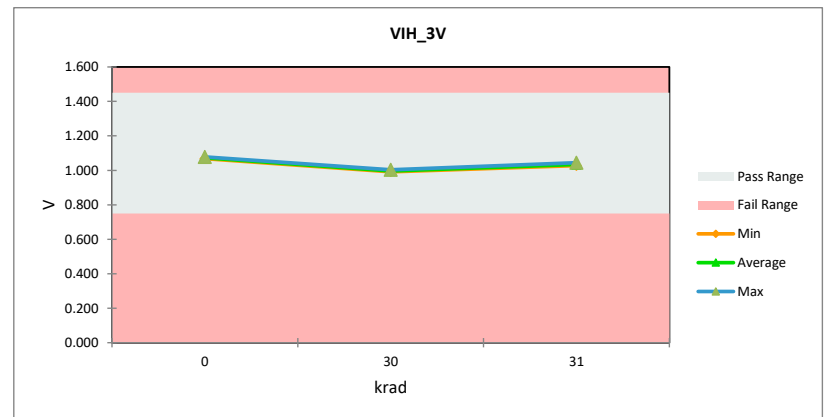

TID Report

SN54SC8T157-SEP

VIH_4P5V						
Units	V					
Max Limit	2					
Min Limit	0.85					
krad	Serial #	PreTestHDR	PostTestHDR	Delta	Delta %	% of Limit Range
0	1	1.378	1.378	0.00	0.00%	0.00%
0	2	1.386	1.386	0.00	0.00%	0.00%
0	3	1.375	1.375	0.00	0.00%	0.00%
0	4	1.383	1.386	0.00	0.19%	0.23%
30	5	1.378	1.318	-0.06	-4.35%	5.22%
30	6	1.383	1.328	-0.05	-3.96%	4.76%
30	7	1.373	1.318	-0.05	-3.99%	4.76%
30	8	1.383	1.326	-0.06	-4.15%	4.99%
30	9	1.375	1.318	-0.06	-4.17%	4.99%
30	10	1.367	1.310	-0.06	-4.20%	4.99%
31	5a	1.378	1.344	-0.03	-2.46%	2.95%
31	6a	1.383	1.354	-0.03	-2.07%	2.49%
31	7a	1.373	1.346	-0.03	-1.90%	2.27%
31	8a	1.383	1.354	-0.03	-2.07%	2.49%
31	9a	1.375	1.344	-0.03	-2.28%	2.72%
31	10a	1.367	1.336	-0.03	-2.29%	2.72%
Max	1.386	1.386	0.00	0.19%	5.22%	
Average	1.377	1.345	-0.03	-2.36%	2.85%	
Min	1.367	1.310	-0.06	-4.35%	0.00%	
Std Dev	0.006	0.025	0.02	1.69%	1.97%	

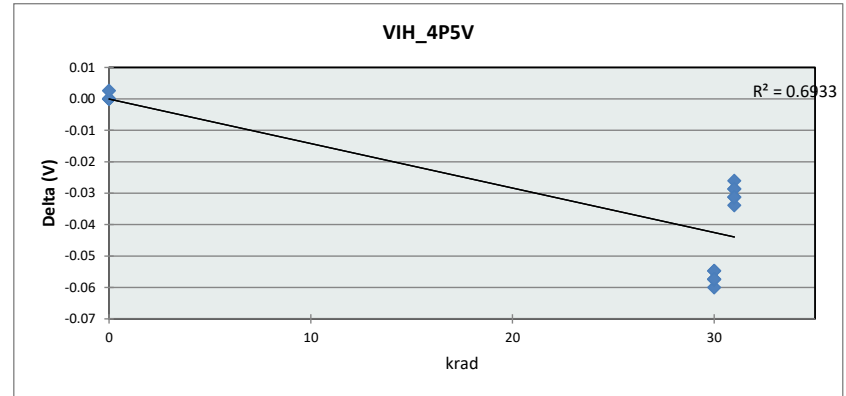

VIH_4P5V			
Units	V		
Max Limit	2		
Min Limit	0.85		
krad	0	30	31
LL	0.850	0.850	0.850
Min	1.375	1.310	1.336
Average	1.381	1.320	1.346
Max	1.386	1.328	1.354
UL	2.000	2.000	2.000

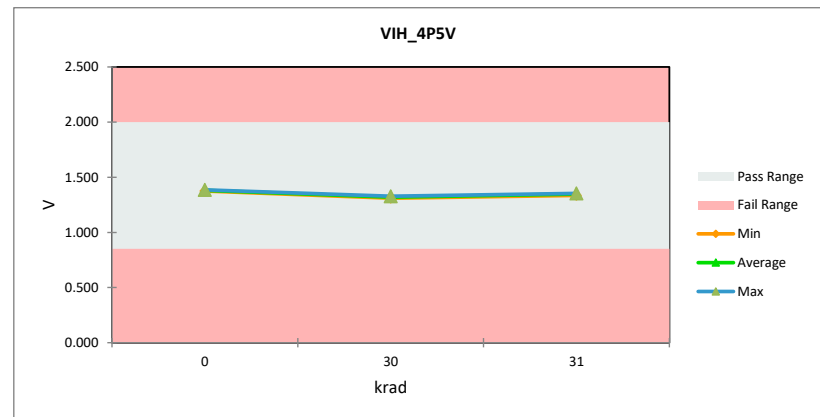

TID Report

SN54SC8T157-SEP

VIH_5P5V						
Units	V					
Max Limit	2					
Min Limit	0.85					
krad	Serial #	PreTestHDR	PostTestHDR	Delta	Delta %	% of Limit Range
0	1	1.562	1.566	0.00	0.21%	0.28%
0	2	1.572	1.572	0.00	0.00%	0.00%
0	3	1.559	1.562	0.00	0.21%	0.28%
0	4	1.572	1.569	0.00	-0.20%	0.28%
30	5	1.562	1.505	-0.06	-3.70%	5.03%
30	6	1.572	1.517	-0.05	-3.48%	4.75%
30	7	1.559	1.508	-0.05	-3.30%	4.47%
30	8	1.572	1.517	-0.05	-3.48%	4.75%
30	9	1.562	1.508	-0.05	-3.50%	4.75%
30	10	1.553	1.498	-0.05	-3.52%	4.75%
31	5a	1.562	1.530	-0.03	-2.06%	2.79%
31	6a	1.572	1.540	-0.03	-2.04%	2.79%
31	7a	1.559	1.533	-0.03	-1.65%	2.24%
31	8a	1.572	1.543	-0.03	-1.84%	2.52%
31	9a	1.562	1.530	-0.03	-2.06%	2.79%
31	10a	1.553	1.521	-0.03	-2.07%	2.79%
Max	1.572	1.572	0.00	0.21%	5.03%	
Average	1.564	1.532	-0.03	-2.03%	2.83%	
Min	1.553	1.498	-0.05	-3.70%	0.00%	
Std Dev	0.007	0.024	0.02	1.43%	1.83%	

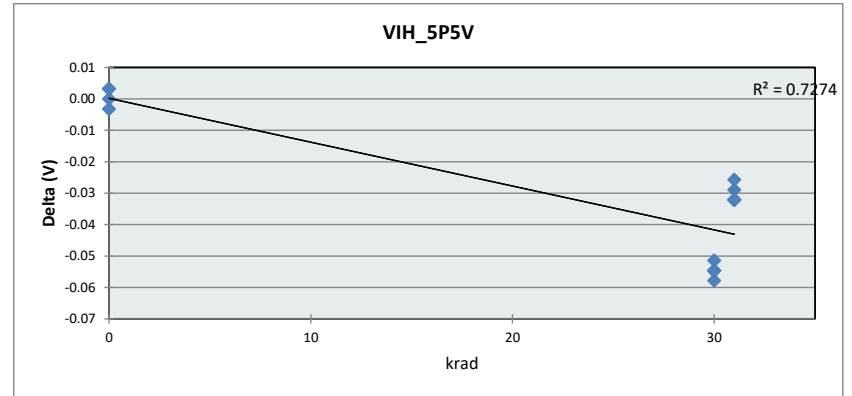

VIH_5P5V			
Units	V		
Max Limit	2		
Min Limit	0.85		
krad	0	30	31
LL	0.850	0.850	0.850
Min	1.562	1.498	1.521
Average	1.567	1.509	1.533
Max	1.572	1.517	1.543
UL	2.000	2.000	2.000

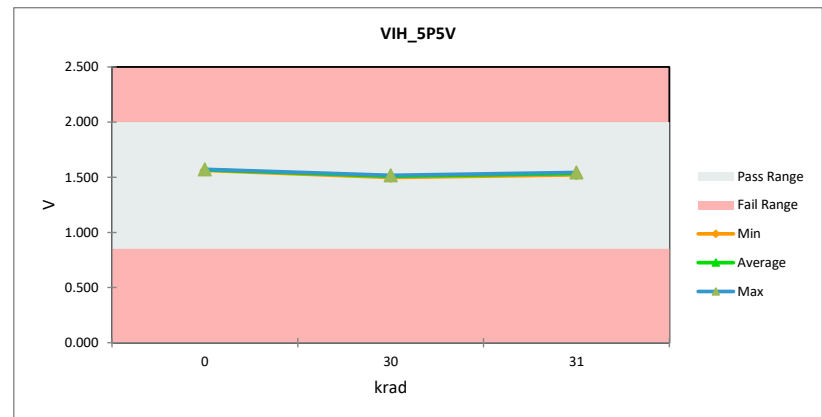

TID Report

SN54SC8T157-SEP

VIL_1P2V						
Units	V					
Max Limit	0.78					
Min Limit	0.18					
krad	Serial #	PreTestHDR	PostTestHDR	Delta	Delta %	% of Limit Range
0	1	0.540	0.540	0.00	0.00%	0.00%
0	2	0.546	0.546	0.00	0.00%	0.00%
0	3	0.540	0.540	0.00	0.00%	0.00%
0	4	0.548	0.548	0.00	0.00%	0.00%
30	5	0.538	0.101	-0.44	-81.15%	72.72%
30	6	0.546	0.111	-0.43	-79.59%	72.38%
30	7	0.538	0.105	-0.43	-80.53%	72.16%
30	8	0.546	0.104	-0.44	-80.94%	73.60%
30	9	0.538	0.107	-0.43	-80.18%	71.94%
30	10	0.539	0.101	-0.44	-81.20%	72.94%
31	5a	0.538	0.343	-0.19	-36.11%	32.35%
31	6a	0.546	0.384	-0.16	-29.71%	27.02%
31	7a	0.538	0.366	-0.17	-31.89%	28.57%
31	8a	0.546	0.403	-0.14	-26.16%	23.79%
31	9a	0.538	0.380	-0.16	-29.37%	26.35%
31	10a	0.539	0.345	-0.19	-36.02%	32.35%
	Max	0.548	0.548	0.00	0.00%	73.60%
	Average	0.541	0.314	-0.23	-42.05%	37.89%
	Min	0.538	0.101	-0.44	-81.20%	0.00%
	Std Dev	0.004	0.182	0.18	33.40%	30.09%

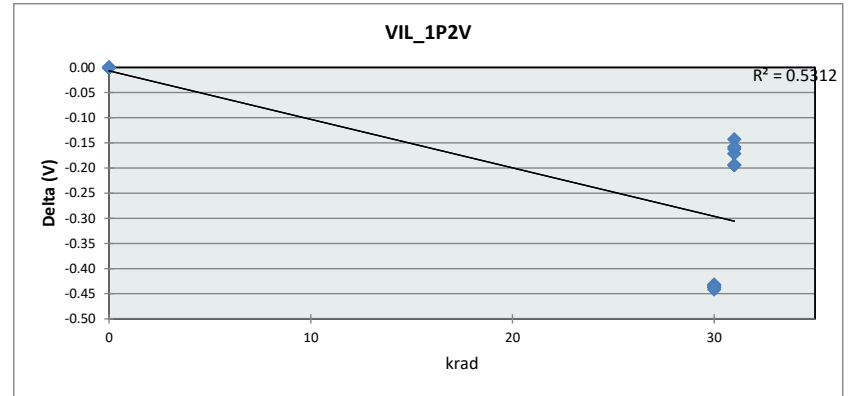

VIL_1P2V			
Units	V		
Max Limit	0.78		
Min Limit	0.18		
krad	0	30	31
LL	0.180	0.180	0.180
Min	0.540	0.101	0.343
Average	0.543	0.105	0.370
Max	0.548	0.111	0.403
UL	0.780	0.780	0.780

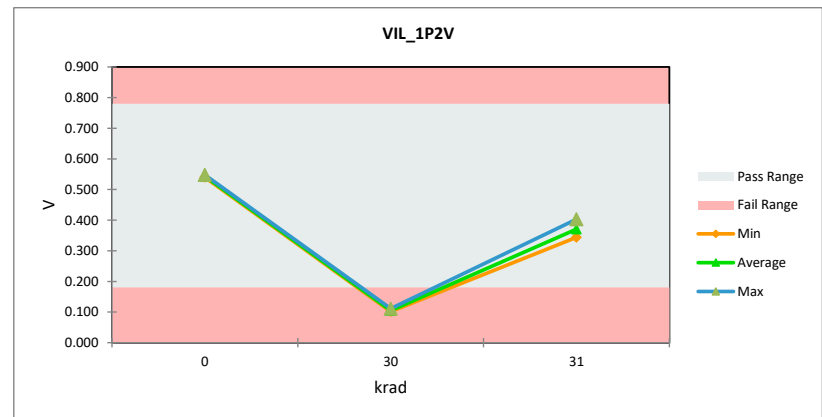

TID Report SN54SC8T157-SEP

VIL_1P65V						
Units	V					
Max Limit	1.1					
Min Limit	0.5					
krad	Serial #	PreTestHDR	PostTestHDR	Delta	Delta %	% of Limit Range
0	1	0.700	0.700	0.00	0.00%	0.00%
0	2	0.705	0.707	0.00	0.27%	0.32%
0	3	0.699	0.700	0.00	0.14%	0.16%
0	4	0.709	0.709	0.00	0.00%	0.00%
30	5	0.698	0.516	-0.18	-26.06%	30.31%
30	6	0.707	0.513	-0.19	-27.38%	32.24%
30	7	0.697	0.515	-0.18	-26.10%	30.31%
30	8	0.705	0.512	-0.19	-27.32%	32.08%
30	9	0.697	0.517	-0.18	-25.82%	29.99%
30	10	0.698	0.517	-0.18	-25.92%	30.15%
31	5a	0.698	0.619	-0.08	-11.23%	13.06%
31	6a	0.707	0.636	-0.07	-9.99%	11.77%
31	7a	0.697	0.617	-0.08	-11.52%	13.38%
31	8a	0.705	0.640	-0.06	-9.20%	10.80%
31	9a	0.697	0.615	-0.08	-11.80%	13.70%
31	10a	0.698	0.622	-0.08	-10.81%	12.58%
Max	0.709	0.709	0.00	0.27%	32.24%	
Average	0.701	0.603	-0.10	-13.92%	16.30%	
Min	0.697	0.512	-0.18	-27.38%	0.00%	
Std Dev	0.004	0.078	0.07	10.94%	12.68%	

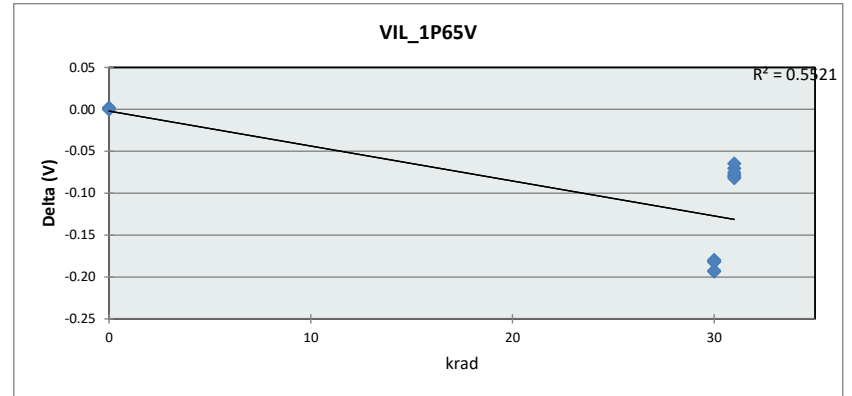

VIL_1P65V			
Units	V		
Max Limit	1.1		
Min Limit	0.5		
krad	0	30	31
LL	0.500	0.500	0.500
Min	0.700	0.512	0.615
Average	0.704	0.515	0.625
Max	0.709	0.517	0.640
UL	1.100	1.100	1.100

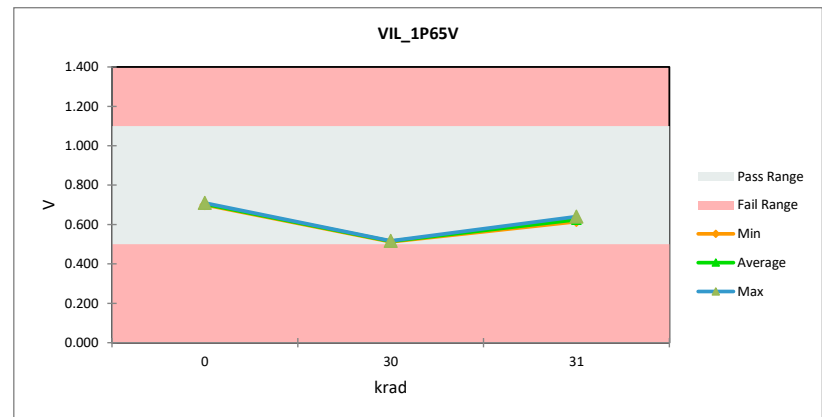

TID Report

SN54SC8T157-SEP

VIL_2P25V						
Units	V					
Max Limit	1.28					
Min Limit	0.65					
krad	Serial #	PreTestHDR	PostTestHDR	Delta	Delta %	% of Limit Range
0	1	0.858	0.855	0.00	-0.32%	0.43%
0	2	0.863	0.864	0.00	0.16%	0.22%
0	3	0.858	0.858	0.00	0.00%	0.00%
0	4	0.867	0.869	0.00	0.16%	0.22%
30	5	0.858	0.765	-0.09	-10.84%	14.76%
30	6	0.866	0.771	-0.09	-10.90%	14.98%
30	7	0.856	0.761	-0.10	-11.18%	15.20%
30	8	0.867	0.771	-0.10	-11.04%	15.20%
30	9	0.854	0.769	-0.08	-9.93%	13.46%
30	10	0.859	0.766	-0.09	-10.83%	14.76%
31	5a	0.858	0.807	-0.05	-5.90%	8.03%
31	6a	0.866	0.819	-0.05	-5.37%	7.38%
31	7a	0.856	0.808	-0.05	-5.59%	7.60%
31	8a	0.867	0.818	-0.05	-5.68%	7.81%
31	9a	0.854	0.803	-0.05	-5.93%	8.03%
31	10a	0.859	0.807	-0.05	-6.05%	8.25%
Max	0.867	0.869	0.00	0.16%	15.20%	
Average	0.860	0.807	-0.05	-6.20%	8.52%	
Min	0.854	0.761	-0.09	-11.18%	0.00%	
Std Dev	0.005	0.038	0.03	4.34%	5.84%	

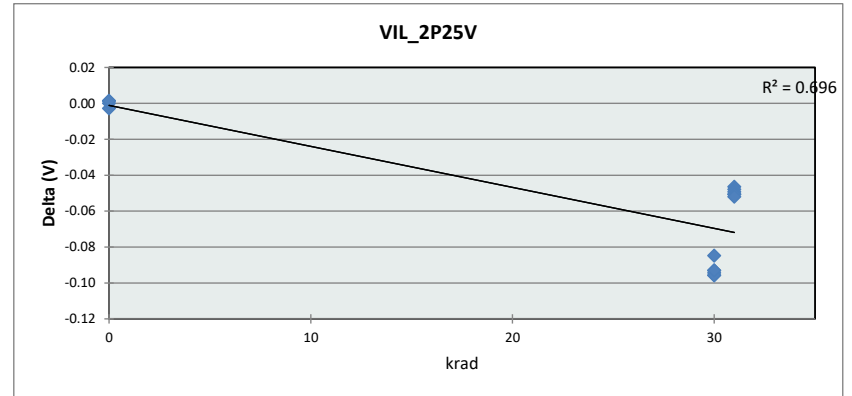

VIL_2P25V			
Units	V		
Max Limit	1.28		
Min Limit	0.65		
krad	0	30	31
LL	0.650	0.650	0.650
Min	0.855	0.761	0.803
Average	0.861	0.767	0.810
Max	0.869	0.771	0.819
UL	1.280	1.280	1.280

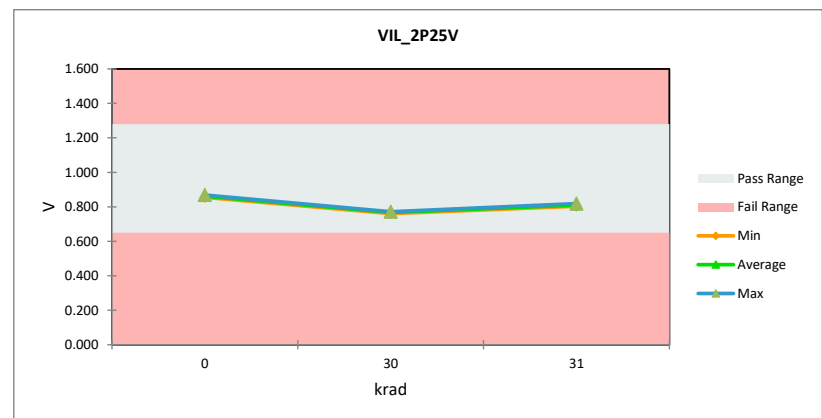

TID Report

SN54SC8T157-SEP

VIL_3V						
Units	V					
Max Limit	1.45					
Min Limit	0.75					
krad	Serial #	PreTestHDR	PostTestHDR	Delta	Delta %	% of Limit Range
0	1	1.038	1.034	0.00	-0.36%	0.53%
0	2	1.040	1.043	0.00	0.36%	0.53%
0	3	1.034	1.030	0.00	-0.36%	0.53%
0	4	1.045	1.049	0.00	0.36%	0.53%
30	5	1.036	0.969	-0.07	-6.49%	9.61%
30	6	1.040	0.976	-0.06	-6.11%	9.07%
30	7	1.028	0.963	-0.07	-6.36%	9.34%
30	8	1.036	0.978	-0.06	-5.59%	8.27%
30	9	1.038	0.972	-0.07	-6.30%	9.34%
30	10	1.028	0.965	-0.06	-6.18%	9.07%
31	5a	1.036	1.002	-0.03	-3.25%	4.80%
31	6a	1.040	1.012	-0.03	-2.70%	4.00%
31	7a	1.028	0.995	-0.03	-3.27%	4.80%
31	8a	1.036	1.010	-0.03	-2.52%	3.74%
31	9a	1.038	1.002	-0.04	-3.42%	5.07%
31	10a	1.028	0.997	-0.03	-3.09%	4.54%
Max	1.045	1.049	0.00	0.36%	9.61%	
Average	1.035	1.000	-0.04	-3.45%	5.24%	
Min	1.028	0.963	-0.07	-6.49%	0.53%	
Std Dev	0.005	0.028	0.02	2.51%	3.51%	

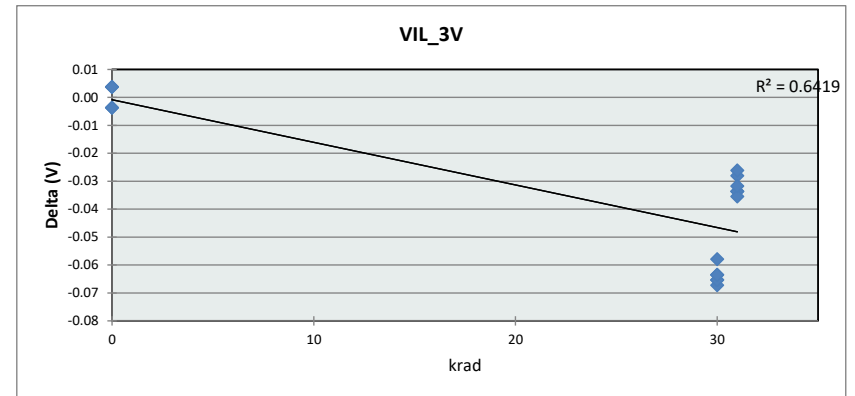

VIL_3V			
Units	V		
Max Limit	1.45		
Min Limit	0.75		
krad	0	30	31
LL	0.750	0.750	0.750
Min	1.030	0.963	0.995
Average	1.039	0.970	1.003
Max	1.049	0.978	1.012
UL	1.450	1.450	1.450

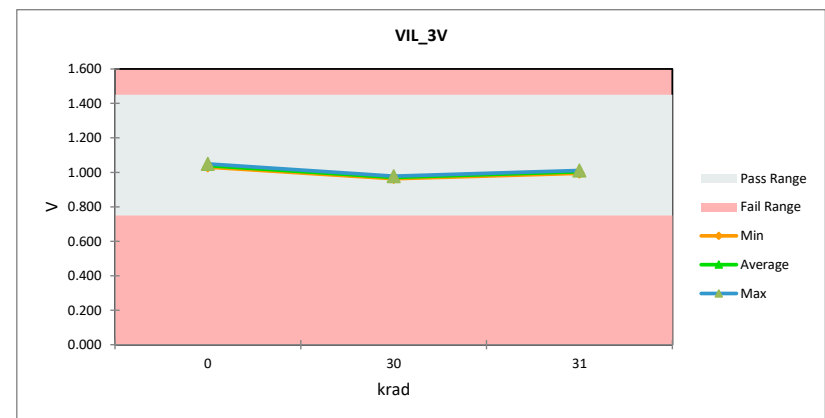

TID Report SN54SC8T157-SEP

VIL_4P5V						
Units	V					
Max Limit	2					
Min Limit	0.85					
krad	Serial #	PreTestHDR	PostTestHDR	Delta	Delta %	% of Limit Range
0	1	1.365	1.365	0.00	0.00%	0.00%
0	2	1.371	1.374	0.00	0.21%	0.25%
0	3	1.362	1.362	0.00	0.00%	0.00%
0	4	1.371	1.371	0.00	0.00%	0.00%
30	5	1.362	1.305	-0.06	-4.21%	4.99%
30	6	1.371	1.313	-0.06	-4.19%	4.99%
30	7	1.362	1.308	-0.05	-4.00%	4.74%
30	8	1.371	1.313	-0.06	-4.19%	4.99%
30	9	1.362	1.305	-0.06	-4.21%	4.99%
30	10	1.356	1.299	-0.06	-4.23%	4.99%
31	5a	1.362	1.331	-0.03	-2.32%	2.74%
31	6a	1.371	1.342	-0.03	-2.09%	2.49%
31	7a	1.362	1.328	-0.03	-2.53%	2.99%
31	8a	1.371	1.342	-0.03	-2.09%	2.49%
31	9a	1.362	1.331	-0.03	-2.32%	2.74%
31	10a	1.356	1.322	-0.03	-2.54%	2.99%
Max	1.371	1.374	0.00	0.21%	4.99%	
Average	1.365	1.332	-0.03	-2.42%	2.90%	
Min	1.356	1.299	-0.06	-4.23%	0.00%	
Std Dev	0.005	0.025	0.02	1.70%	1.96%	

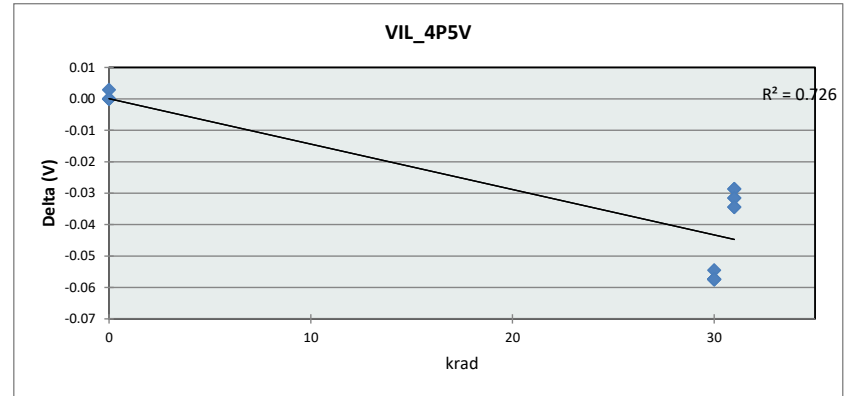

VIL_4P5V			
Units	V		
Max Limit	2		
Min Limit	0.85		
krad	0	30	31
LL	0.850	0.850	0.850
Min	1.362	1.299	1.322
Average	1.368	1.307	1.333
Max	1.374	1.313	1.342
UL	2.000	2.000	2.000

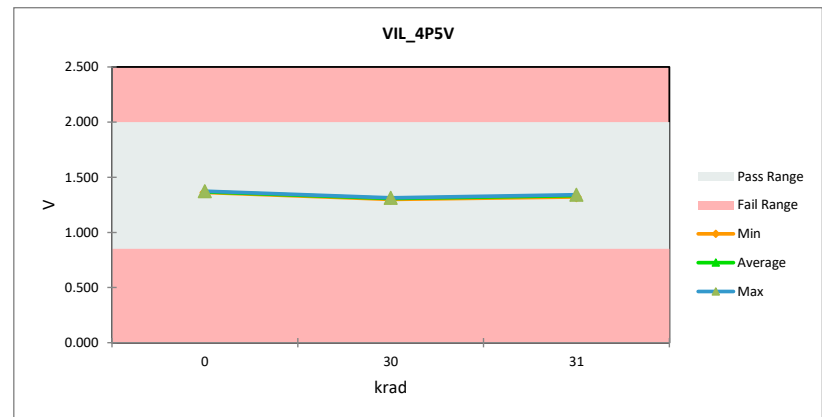

TID Report

SN54SC8T157-SEP

VIL_5P5V						
Units	V					
Max Limit	2					
Min Limit	0.85					
krad	Serial #	PreTestHDR	PostTestHDR	Delta	Delta %	% of Limit Range
0	1	1.550	1.550	0.00	0.00%	0.00%
0	2	1.557	1.557	0.00	0.00%	0.00%
0	3	1.546	1.546	0.00	0.00%	0.00%
0	4	1.553	1.557	0.00	0.23%	0.31%
30	5	1.546	1.490	-0.06	-3.66%	4.92%
30	6	1.553	1.500	-0.05	-3.41%	4.61%
30	7	1.543	1.493	-0.05	-3.21%	4.30%
30	8	1.557	1.500	-0.06	-3.63%	4.92%
30	9	1.546	1.493	-0.05	-3.43%	4.61%
30	10	1.535	1.482	-0.05	-3.45%	4.61%
31	5a	1.546	1.514	-0.03	-2.06%	2.77%
31	6a	1.553	1.525	-0.03	-1.82%	2.46%
31	7a	1.543	1.514	-0.03	-1.83%	2.46%
31	8a	1.557	1.528	-0.03	-1.82%	2.46%
31	9a	1.546	1.514	-0.03	-2.06%	2.77%
31	10a	1.535	1.504	-0.03	-2.07%	2.77%
Max		1.557	1.557	0.00	0.23%	4.92%
Average		1.548	1.517	-0.03	-2.01%	2.75%
Min		1.535	1.482	-0.05	-3.66%	0.00%
Std Dev		0.007	0.025	0.02	1.42%	1.85%

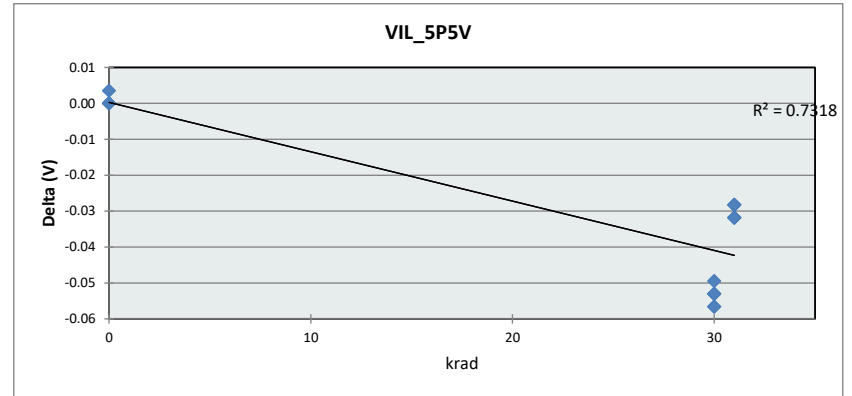

VIL_5P5V			
Units	V		
Max Limit	2		
Min Limit	0.85		
krad	0	30	31
LL	0.850	0.850	0.850
Min	1.546	1.482	1.504
Average	1.552	1.493	1.517
Max	1.557	1.500	1.528
UL	2.000	2.000	2.000

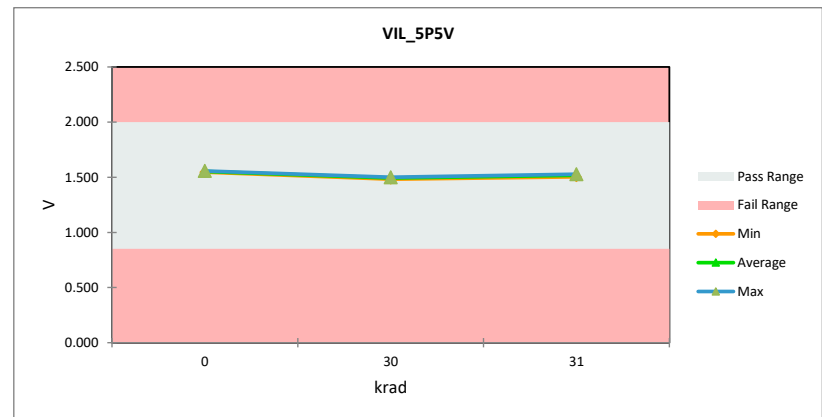

TID Report

SN54SC8T157-SEP

VOH_N1MA_1P2V						
Units	V					
Max Limit	1.3					
Min Limit	0.8					
krad	Serial #	PreTestHDR	PostTestHDR	Delta	Delta %	% of Limit Range
0	1	1.134	1.136	0.00	0.15%	0.34%
0	2	1.137	1.137	0.00	0.01%	0.02%
0	3	1.136	1.136	0.00	0.01%	0.02%
0	4	1.137	1.137	0.00	0.01%	0.01%
30	5	1.136	1.129	-0.01	-0.58%	1.31%
30	6	1.137	1.130	-0.01	-0.56%	1.27%
30	7	1.136	1.130	-0.01	-0.49%	1.12%
30	8	1.137	1.129	-0.01	-0.63%	1.44%
30	9	1.136	1.131	-0.01	-0.45%	1.02%
30	10	1.136	1.130	-0.01	-0.56%	1.27%
31	5a	1.136	1.134	0.00	-0.10%	0.23%
31	6a	1.137	1.135	0.00	-0.11%	0.26%
31	7a	1.136	1.135	0.00	-0.11%	0.25%
31	8a	1.137	1.135	0.00	-0.10%	0.24%
31	9a	1.136	1.135	0.00	-0.11%	0.24%
31	10a	1.136	1.134	0.00	-0.15%	0.34%
Max	1.137	1.137	0.00	0.15%	1.44%	
Average	1.136	1.133	0.00	-0.24%	0.59%	
Min	1.134	1.129	-0.01	-0.63%	0.01%	
Std Dev	0.001	0.003	0.00	0.26%	0.54%	

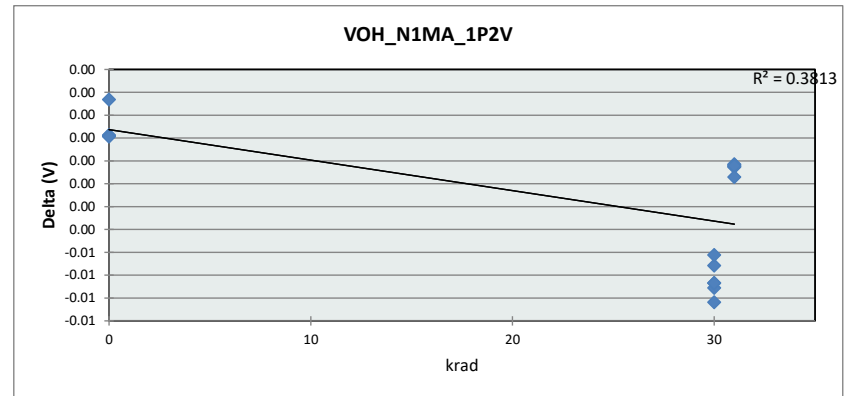

VOH_N1MA_1P2V			
Units	V		
Max Limit	1.3		
Min Limit	0.8		
krad	0	30	31
LL	0.800	0.800	0.800
Min	1.136	1.129	1.134
Average	1.136	1.130	1.135
Max	1.137	1.131	1.135
UL	1.300	1.300	1.300

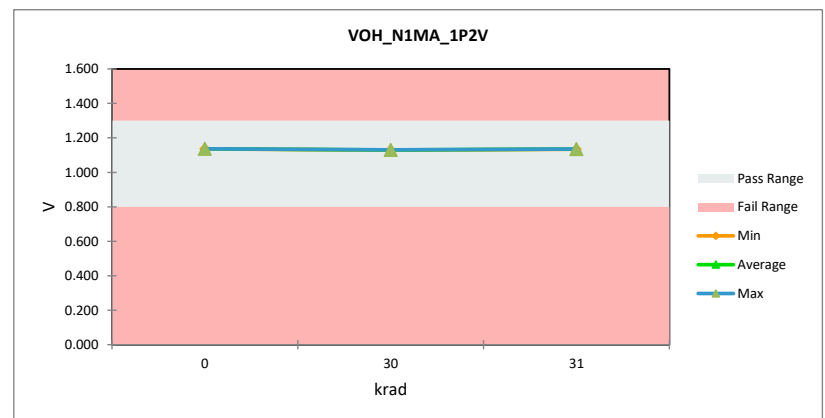

TID Report

SN54SC8T157-SEP

VOH_N2MA_1P65V						
Units	V					
Max Limit	1.75					
Min Limit	1.21					
krad	Serial #	PreTestHDR	PostTestHDR	Delta	Delta %	% of Limit Range
0	1	1.566	1.569	0.00	0.22%	0.63%
0	2	1.570	1.570	0.00	0.00%	0.00%
0	3	1.569	1.569	0.00	0.00%	0.01%
0	4	1.570	1.570	0.00	0.01%	0.03%
30	5	1.569	1.565	0.00	-0.24%	0.69%
30	6	1.570	1.567	0.00	-0.22%	0.64%
30	7	1.569	1.566	0.00	-0.19%	0.56%
30	8	1.570	1.566	0.00	-0.26%	0.75%
30	9	1.569	1.567	0.00	-0.17%	0.48%
30	10	1.569	1.566	0.00	-0.20%	0.57%
31	5a	1.569	1.568	0.00	-0.04%	0.12%
31	6a	1.570	1.569	0.00	-0.04%	0.12%
31	7a	1.569	1.569	0.00	-0.05%	0.13%
31	8a	1.570	1.569	0.00	-0.03%	0.08%
31	9a	1.569	1.568	0.00	-0.05%	0.13%
31	10a	1.569	1.568	0.00	-0.05%	0.13%
Max	1.570	1.570	0.00	0.22%	0.75%	
Average	1.569	1.568	0.00	-0.08%	0.32%	
Min	1.566	1.565	0.00	-0.26%	0.00%	
Std Dev	0.001	0.002	0.00	0.12%	0.28%	

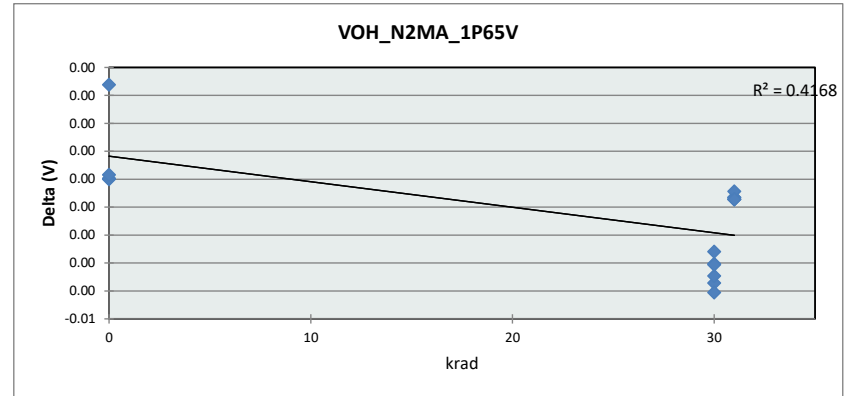

VOH_N2MA_1P65V			
Units	V		
Max Limit	1.75		
Min Limit	1.21		
krad	0	30	31
LL	1.210	1.210	1.210
Min	1.569	1.565	1.568
Average	1.570	1.566	1.569
Max	1.570	1.567	1.569
UL	1.750	1.750	1.750

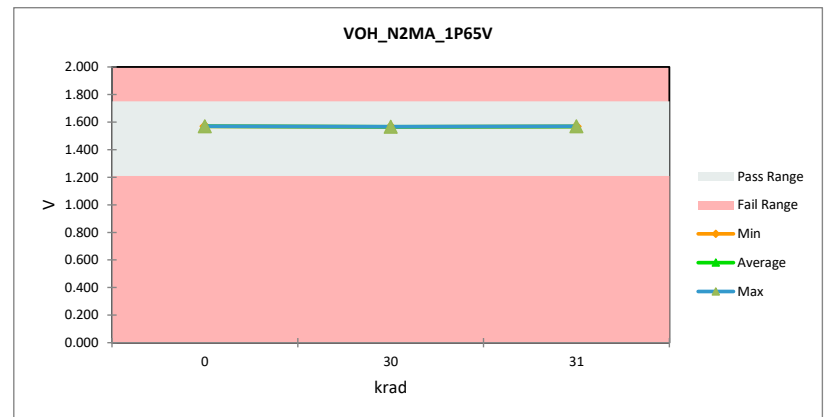

TID Report

SN54SC8T157-SEP

VOH_N3MA_2P25V						
Units	V					
Max Limit	2.35					
Min Limit	1.93					
krad	Serial #	PreTestHDR	PostTestHDR	Delta	Delta %	% of Limit Range
0	1	2.153	2.158	0.00	0.23%	1.19%
0	2	2.159	2.159	0.00	0.00%	0.01%
0	3	2.158	2.158	0.00	0.00%	0.01%
0	4	2.159	2.159	0.00	0.01%	0.07%
30	5	2.158	2.155	0.00	-0.11%	0.58%
30	6	2.159	2.156	0.00	-0.12%	0.60%
30	7	2.158	2.156	0.00	-0.10%	0.49%
30	8	2.159	2.156	0.00	-0.13%	0.69%
30	9	2.158	2.156	0.00	-0.09%	0.44%
30	10	2.158	2.156	0.00	-0.10%	0.54%
31	5a	2.158	2.158	0.00	-0.02%	0.08%
31	6a	2.159	2.158	0.00	-0.02%	0.10%
31	7a	2.158	2.157	0.00	-0.03%	0.17%
31	8a	2.159	2.158	0.00	-0.02%	0.12%
31	9a	2.158	2.158	0.00	-0.03%	0.16%
31	10a	2.158	2.157	0.00	-0.03%	0.17%
Max	2.159	2.159	0.00	0.23%	1.19%	
Average	2.158	2.157	0.00	-0.04%	0.34%	
Min	2.153	2.155	0.00	-0.13%	0.01%	
Std Dev	0.001	0.001	0.00	0.09%	0.33%	

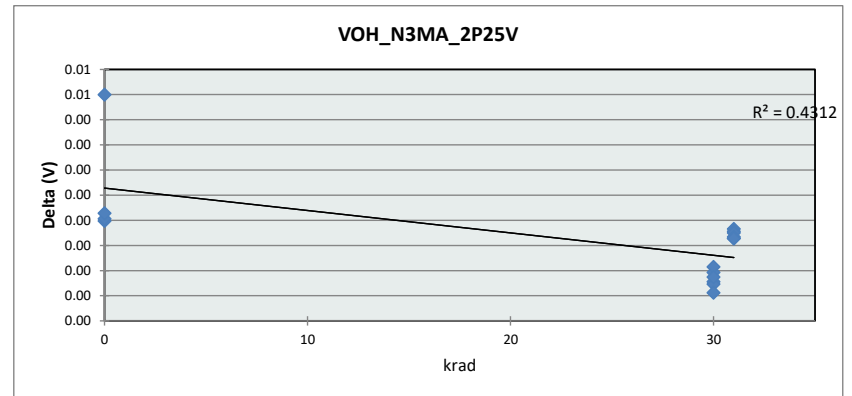

VOH_N3MA_2P25V			
Units	V		
Max Limit	2.35		
Min Limit	1.93		
krad	0	30	31
LL	1.930	1.930	1.930
Min	2.158	2.155	2.157
Average	2.159	2.156	2.158
Max	2.159	2.156	2.158
UL	2.350	2.350	2.350

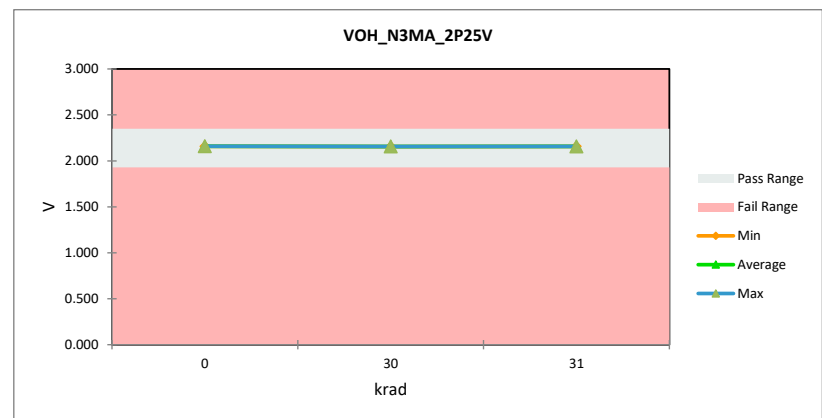

TID Report

SN54SC8T157-SEP

VOH_N5P5MA_3V						
Units	V					
Max Limit	3.1					
Min Limit	2.49					
krad	Serial #	PreTestHDR	PostTestHDR	Delta	Delta %	% of Limit Range
0	1	2.849	2.859	0.01	0.34%	1.57%
0	2	2.860	2.860	0.00	0.00%	0.01%
0	3	2.858	2.859	0.00	0.01%	0.06%
0	4	2.860	2.860	0.00	0.01%	0.06%
30	5	2.858	2.857	0.00	-0.04%	0.21%
30	6	2.859	2.858	0.00	-0.04%	0.19%
30	7	2.858	2.858	0.00	-0.03%	0.14%
30	8	2.860	2.858	0.00	-0.06%	0.29%
30	9	2.858	2.858	0.00	-0.01%	0.04%
30	10	2.858	2.857	0.00	-0.03%	0.16%
31	5a	2.858	2.857	0.00	-0.03%	0.12%
31	6a	2.859	2.859	0.00	-0.02%	0.10%
31	7a	2.858	2.858	0.00	-0.02%	0.11%
31	8a	2.860	2.859	0.00	-0.03%	0.13%
31	9a	2.858	2.857	0.00	-0.03%	0.12%
31	10a	2.858	2.858	0.00	-0.03%	0.14%
Max		2.860	2.860	0.00	0.34%	1.57%
Average		2.858	2.858	0.00	0.00%	0.22%
Min		2.849	2.857	0.01	-0.06%	0.01%
Std Dev		0.003	0.001	0.00	0.09%	0.37%

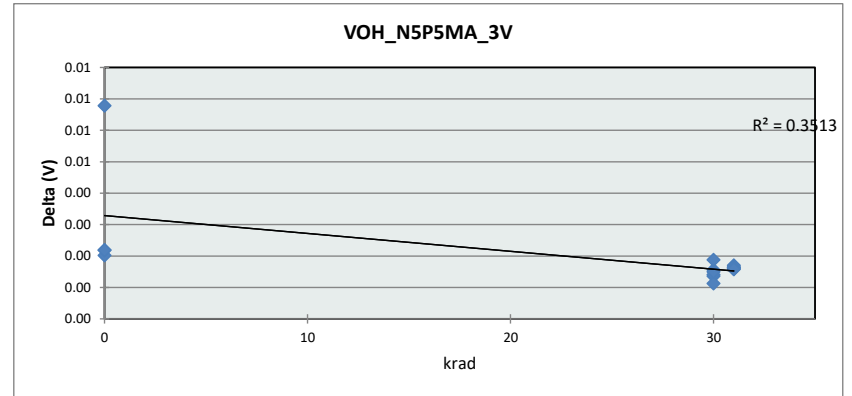

VOH_N5P5MA_3V			
Units	V		
Max Limit	3.1		
Min Limit	2.49		
krad	0	30	31
LL	2.490	2.490	2.490
Min	2.859	2.857	2.857
Average	2.859	2.858	2.858
Max	2.860	2.858	2.859
UL	3.100	3.100	3.100

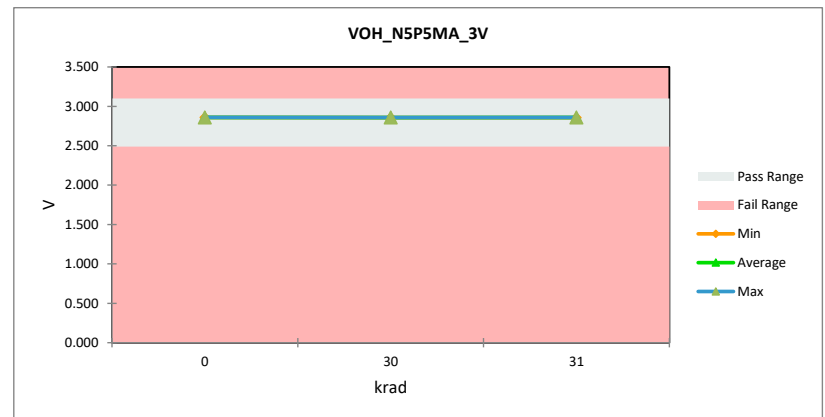

TID Report

SN54SC8T157-SEP

VOH_N8MA_4P5V						
Units	V					
Max Limit	4.6					
Min Limit	3.95					
krad	Serial #	PreTestHDR	PostTestHDR	Delta	Delta %	% of Limit Range
0	1	4.315	4.328	0.01	0.32%	2.09%
0	2	4.330	4.330	0.00	0.00%	0.00%
0	3	4.328	4.329	0.00	0.01%	0.05%
0	4	4.330	4.330	0.00	0.00%	0.01%
30	5	4.328	4.328	0.00	-0.01%	0.06%
30	6	4.330	4.329	0.00	-0.01%	0.04%
30	7	4.328	4.328	0.00	-0.01%	0.06%
30	8	4.330	4.329	0.00	-0.01%	0.04%
30	9	4.328	4.328	0.00	-0.01%	0.04%
30	10	4.328	4.328	0.00	-0.01%	0.07%
31	5a	4.328	4.327	0.00	-0.02%	0.15%
31	6a	4.330	4.329	0.00	-0.02%	0.12%
31	7a	4.328	4.327	0.00	-0.02%	0.16%
31	8a	4.330	4.329	0.00	-0.01%	0.10%
31	9a	4.328	4.327	0.00	-0.02%	0.10%
31	10a	4.328	4.327	0.00	-0.02%	0.15%
Max	4.330	4.330	0.00	0.32%	2.09%	
Average	4.328	4.328	0.00	0.01%	0.20%	
Min	4.315	4.327	0.01	-0.02%	0.00%	
Std Dev	0.004	0.001	0.00	0.08%	0.51%	

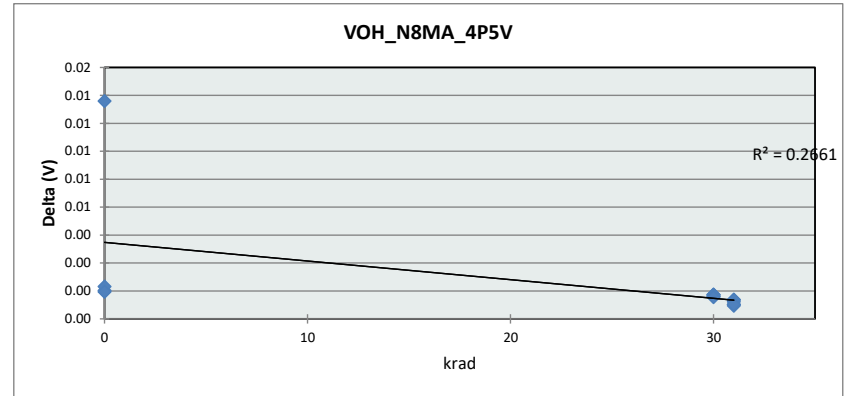

VOH_N8MA_4P5V			
Units	V		
Max Limit	4.6		
Min Limit	3.95		
krad	0	30	31
LL	3.950	3.950	3.950
Min	4.328	4.328	4.327
Average	4.329	4.328	4.328
Max	4.330	4.329	4.329
UL	4.600	4.600	4.600

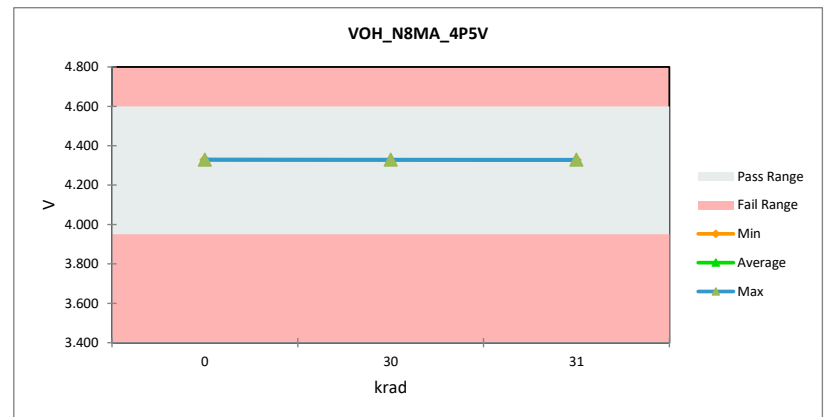

TID Report

SN54SC8T157-SEP

VOH_N24MA_5P5V						
Units	V					
Max Limit	5.6					
Min Limit	3.15					
krad	Serial #	PreTestHDR	PostTestHDR	Delta	Delta %	% of Limit Range
0	1	4.966	5.008	0.04	0.85%	1.72%
0	2	5.012	5.012	0.00	0.00%	0.01%
0	3	5.008	5.009	0.00	0.01%	0.03%
0	4	5.012	5.013	0.00	0.01%	0.03%
30	5	5.007	5.007	0.00	-0.01%	0.02%
30	6	5.012	5.011	0.00	-0.01%	0.03%
30	7	5.008	5.007	0.00	-0.01%	0.02%
30	8	5.011	5.011	0.00	0.00%	0.01%
30	9	5.007	5.007	0.00	0.00%	0.01%
30	10	5.008	5.007	0.00	-0.01%	0.03%
31	5a	5.007	5.005	0.00	-0.04%	0.07%
31	6a	5.012	5.010	0.00	-0.03%	0.06%
31	7a	5.008	5.006	0.00	-0.03%	0.06%
31	8a	5.011	5.010	0.00	-0.03%	0.06%
31	9a	5.007	5.006	0.00	-0.03%	0.06%
31	10a	5.008	5.006	0.00	-0.04%	0.09%
Max	5.012	5.013	0.00	0.85%	1.72%	
Average	5.007	5.008	0.00	0.04%	0.14%	
Min	4.966	5.005	0.04	-0.04%	0.01%	
Std Dev	0.011	0.002	-0.01	0.22%	0.42%	

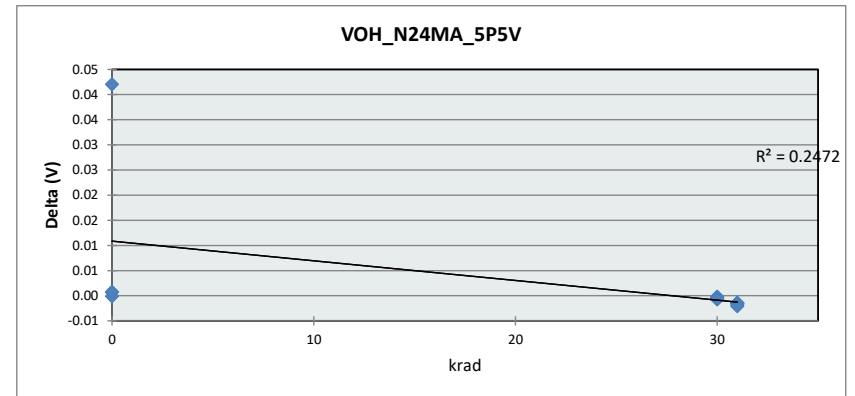

VOH_N24MA_5P5V			
Units	V		
Max Limit	5.6		
Min Limit	3.15		
krad	0	30	31
LL	3.150	3.150	3.150
Min	5.008	5.007	5.005
Average	5.010	5.008	5.007
Max	5.013	5.011	5.010
UL	5.600	5.600	5.600

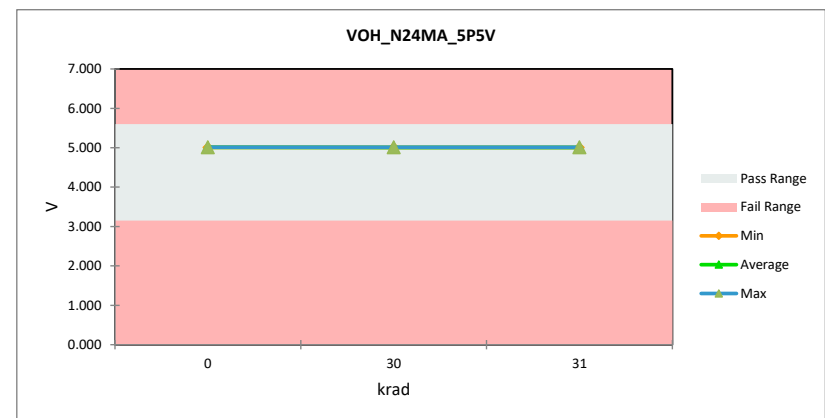

TID Report SN54SC8T157-SEP

VOH_N50UA_1P2V						
Units	V					
Max Limit	1.3					
Min Limit	1					
krad	Serial #	PreTestHDR	PostTestHDR	Delta	Delta %	% of Limit Range
0	1	1.197	1.197	0.00	0.01%	0.04%
0	2	1.197	1.197	0.00	-0.01%	0.03%
0	3	1.197	1.197	0.00	0.01%	0.02%
0	4	1.197	1.197	0.00	0.00%	0.01%
30	5	1.197	1.191	-0.01	-0.44%	1.77%
30	6	1.197	1.192	0.00	-0.39%	1.55%
30	7	1.197	1.192	0.00	-0.36%	1.43%
30	8	1.197	1.191	-0.01	-0.48%	1.91%
30	9	1.197	1.193	0.00	-0.31%	1.22%
30	10	1.197	1.192	0.00	-0.39%	1.54%
31	5a	1.197	1.196	0.00	-0.06%	0.26%
31	6a	1.197	1.196	0.00	-0.05%	0.22%
31	7a	1.197	1.196	0.00	-0.05%	0.21%
31	8a	1.197	1.196	0.00	-0.05%	0.20%
31	9a	1.197	1.196	0.00	-0.02%	0.09%
31	10a	1.197	1.196	0.00	-0.06%	0.24%
Max	1.197	1.197	0.00	0.01%	1.91%	
Average	1.197	1.195	0.00	-0.17%	0.67%	
Min	1.197	1.191	-0.01	-0.48%	0.01%	
Std Dev	0.000	0.002	0.00	0.19%	0.74%	

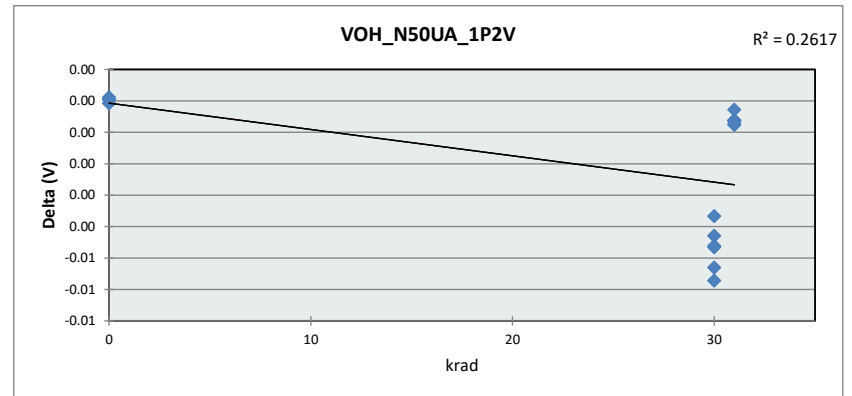

VOH_N50UA_1P2V			
Units	V		
Max Limit	1.3		
Min Limit	1		
krad	0	30	31
LL	1.000	1.000	1.000
Min	1.197	1.191	1.196
Average	1.197	1.192	1.196
Max	1.197	1.193	1.196
UL	1.300	1.300	1.300

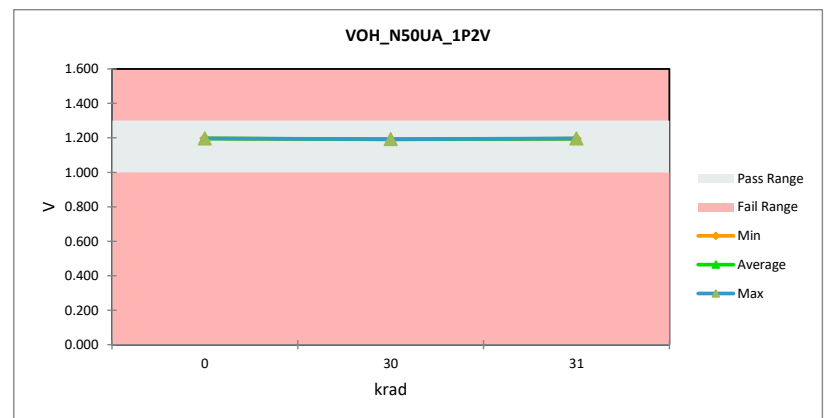

TID Report SN54SC8T157-SEP

VOH_N50UA_5P5V						
Units	V					
Max Limit	5.6					
Min Limit	5.3					
krad	Serial #	PreTestHDR	PostTestHDR	Delta	Delta %	% of Limit Range
0	1	5.498	5.498	0.00	0.00%	0.01%
0	2	5.498	5.498	0.00	0.00%	0.01%
0	3	5.498	5.498	0.00	0.00%	0.01%
0	4	5.499	5.498	0.00	0.00%	0.05%
30	5	5.498	5.496	0.00	-0.04%	0.76%
30	6	5.499	5.497	0.00	-0.04%	0.65%
30	7	5.498	5.497	0.00	-0.03%	0.64%
30	8	5.498	5.496	0.00	-0.04%	0.81%
30	9	5.498	5.497	0.00	-0.03%	0.50%
30	10	5.499	5.496	0.00	-0.04%	0.69%
31	5a	5.498	5.498	0.00	-0.01%	0.17%
31	6a	5.499	5.498	0.00	-0.01%	0.12%
31	7a	5.498	5.498	0.00	-0.01%	0.09%
31	8a	5.498	5.498	0.00	-0.01%	0.10%
31	9a	5.498	5.498	0.00	-0.01%	0.14%
31	10a	5.499	5.498	0.00	-0.01%	0.13%
Max	5.499	5.498	0.00	0.00%	0.81%	
Average	5.498	5.498	0.00	-0.02%	0.30%	
Min	5.498	5.496	0.00	-0.04%	0.01%	
Std Dev	0.000	0.001	0.00	0.02%	0.31%	

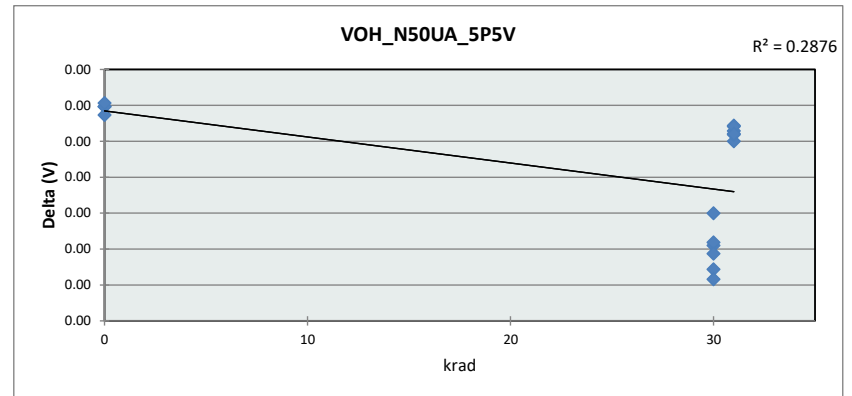

VOH_N50UA_5P5V			
Units	V		
Max Limit	5.6		
Min Limit	5.3		
krad	0	30	31
LL	5.300	5.300	5.300
Min	5.498	5.496	5.498
Average	5.498	5.496	5.498
Max	5.498	5.497	5.498
UL	5.600	5.600	5.600

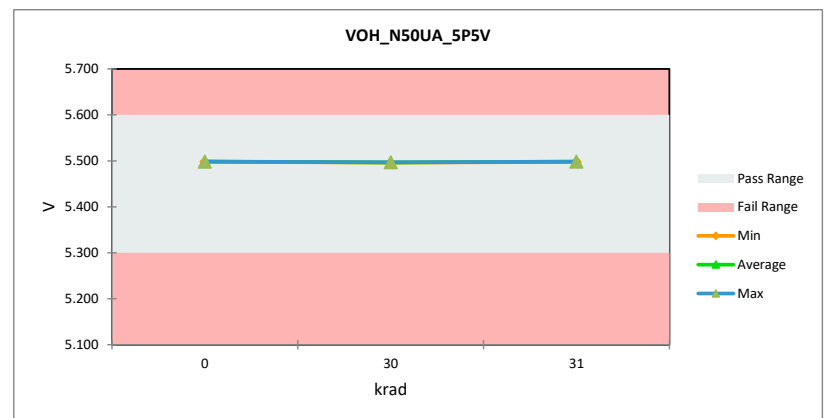

TID Report

SN54SC8T157-SEP

VOL_1MA_1P2V						
Units	V					
Max Limit	0.2					
Min Limit	-0.001					
krad	Serial #	PreTestHDR	PostTestHDR	Delta	Delta %	% of Limit Range
0	1	0.049	0.050	0.00	0.14%	0.04%
0	2	0.050	0.050	0.00	0.05%	0.01%
0	3	0.049	0.049	0.00	0.25%	0.06%
0	4	0.050	0.050	0.00	0.12%	0.03%
30	5	0.050	0.049	0.00	-2.30%	0.57%
30	6	0.050	0.049	0.00	-2.64%	0.66%
30	7	0.050	0.049	0.00	-2.07%	0.51%
30	8	0.050	0.049	0.00	-2.49%	0.62%
30	9	0.049	0.048	0.00	-2.07%	0.51%
30	10	0.050	0.048	0.00	-2.32%	0.57%
31	5a	0.050	0.049	0.00	-1.61%	0.40%
31	6a	0.050	0.050	0.00	-1.65%	0.41%
31	7a	0.050	0.049	0.00	-0.93%	0.23%
31	8a	0.050	0.050	0.00	-1.11%	0.28%
31	9a	0.049	0.049	0.00	-1.08%	0.26%
31	10a	0.050	0.049	0.00	-1.62%	0.40%
Max	0.050	0.050	0.00	0.25%	0.66%	
Average	0.050	0.049	0.00	-1.33%	0.35%	
Min	0.049	0.048	0.00	-2.64%	0.01%	
Std Dev	0.000	0.001	0.00	1.01%	0.22%	

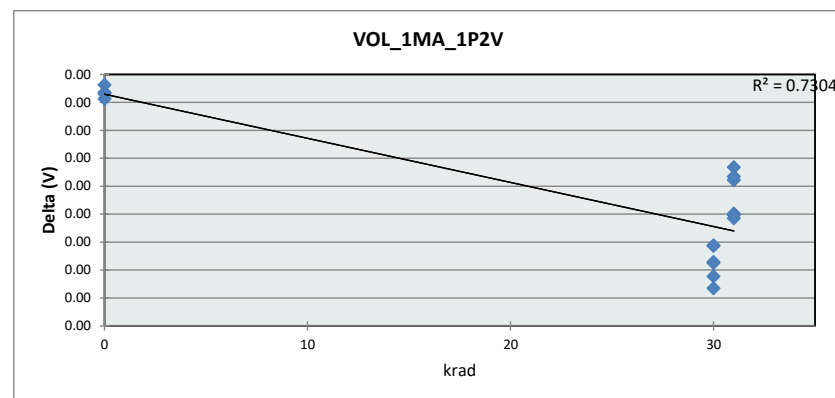

VOL_1MA_1P2V			
Units	V		
Max Limit	0.2		
Min Limit	-0.001		
krad	0	30	31
LL	-0.001	-0.001	-0.001
Min	0.049	0.048	0.049
Average	0.050	0.049	0.049
Max	0.050	0.049	0.050
UL	0.200	0.200	0.200

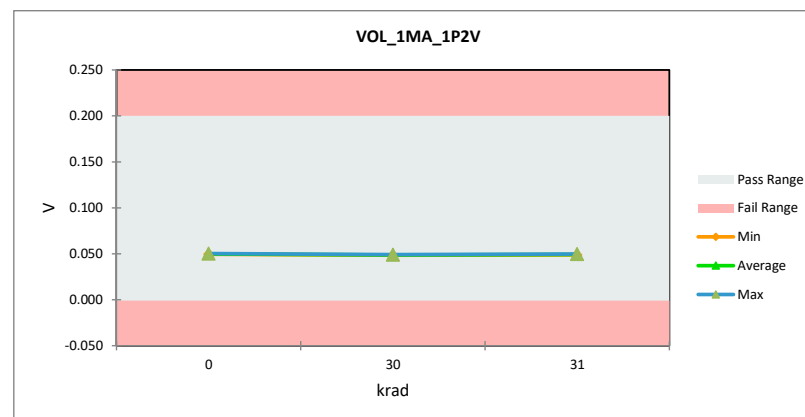

TID Report

SN54SC8T157-SEP

VOL_2MA_1P65V						
Units		V				
Max Limit		0.25				
Min Limit		-0.001				
krad	Serial #	PreTestHDR	PostTestHDR	Delta	Delta %	% of Limit Range
0	1	0.061	0.060	0.00	-0.57%	0.14%
0	2	0.060	0.060	0.00	0.10%	0.02%
0	3	0.060	0.061	0.00	0.17%	0.04%
0	4	0.061	0.060	0.00	-0.12%	0.03%
30	5	0.061	0.060	0.00	-0.59%	0.14%
30	6	0.061	0.060	0.00	-0.59%	0.14%
30	7	0.061	0.060	0.00	-0.86%	0.21%
30	8	0.061	0.060	0.00	-0.65%	0.16%
30	9	0.061	0.060	0.00	-0.34%	0.08%
30	10	0.061	0.060	0.00	-0.61%	0.15%
31	5a	0.061	0.060	0.00	-0.51%	0.12%
31	6a	0.061	0.060	0.00	-0.41%	0.10%
31	7a	0.061	0.061	0.00	-0.37%	0.09%
31	8a	0.061	0.060	0.00	-0.50%	0.12%
31	9a	0.061	0.060	0.00	-0.36%	0.09%
31	10a	0.061	0.060	0.00	-0.48%	0.12%
Max		0.061	0.061	0.00	0.17%	0.21%
Average		0.061	0.060	0.00	-0.42%	0.11%
Min		0.060	0.060	0.00	-0.86%	0.02%
Std Dev		0.000	0.000	0.00	0.27%	0.05%

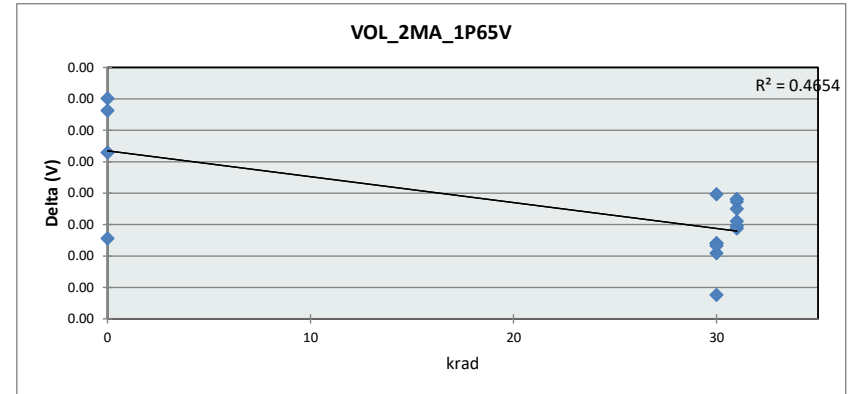

VOL_2MA_1P65V			
Units		V	
Max Limit		0.25	
Min Limit		-0.001	
krad	0	30	31
LL	-0.001	-0.001	-0.001
Min	0.060	0.060	0.060
Average	0.060	0.060	0.060
Max	0.061	0.060	0.061
UL	0.250	0.250	0.250

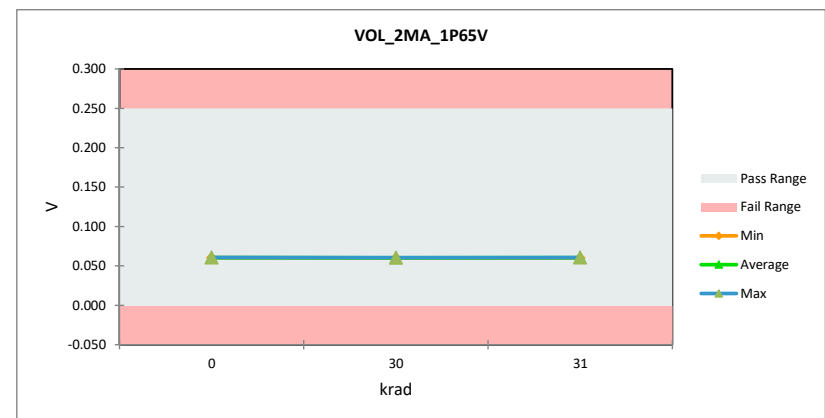

TID Report

SN54SC8T157-SEP

VOL_3MA_2P25V						
Units	V					
Max Limit	0.2					
Min Limit	-0.001					
krad	Serial #	PreTestHDR	PostTestHDR	Delta	Delta %	% of Limit Range
0	1	0.070	0.070	0.00	-0.40%	0.14%
0	2	0.069	0.069	0.00	0.28%	0.10%
0	3	0.070	0.070	0.00	0.05%	0.02%
0	4	0.069	0.069	0.00	0.18%	0.06%
30	5	0.070	0.070	0.00	0.22%	0.08%
30	6	0.069	0.069	0.00	0.02%	0.01%
30	7	0.070	0.070	0.00	0.06%	0.02%
30	8	0.069	0.070	0.00	0.39%	0.13%
30	9	0.070	0.070	0.00	0.02%	0.01%
30	10	0.070	0.070	0.00	0.00%	0.00%
31	5a	0.070	0.070	0.00	-0.22%	0.08%
31	6a	0.069	0.069	0.00	-0.23%	0.08%
31	7a	0.070	0.070	0.00	-0.22%	0.08%
31	8a	0.069	0.069	0.00	-0.23%	0.08%
31	9a	0.070	0.070	0.00	-0.13%	0.05%
31	10a	0.070	0.070	0.00	0.04%	0.02%
Max	0.070	0.070	0.00	0.39%	0.14%	
Average	0.070	0.070	0.00	-0.01%	0.06%	
Min	0.069	0.069	0.00	-0.40%	0.00%	
Std Dev	0.000	0.000	0.00	0.22%	0.04%	

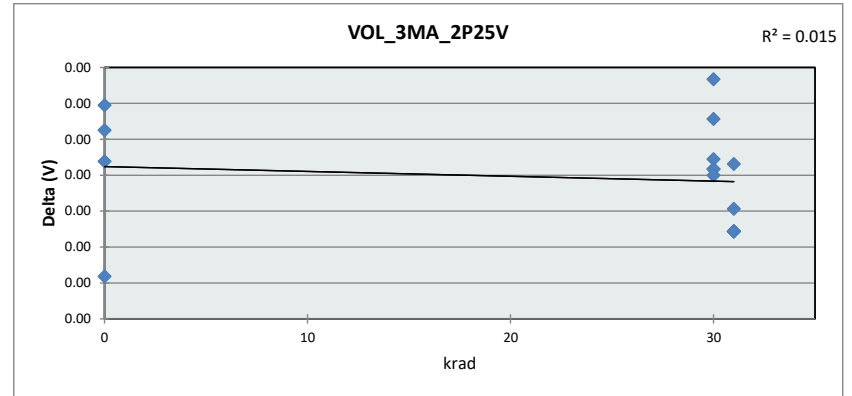

VOL_3MA_2P25V			
Units	V		
Max Limit	0.2		
Min Limit	-0.001		
krad	0	30	31
LL	-0.001	-0.001	-0.001
Min	0.069	0.069	0.069
Average	0.070	0.070	0.070
Max	0.070	0.070	0.070
UL	0.200	0.200	0.200

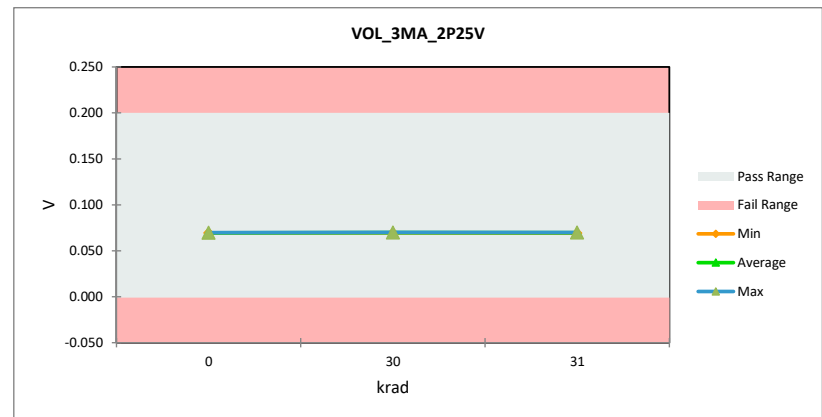

TID Report

SN54SC8T157-SEP

VOL_5P5MA_3V						
Units	V					
Max Limit	0.25					
Min Limit	-0.001					
krad	Serial #	PreTestHDR	PostTestHDR	Delta	Delta %	% of Limit Range
0	1	0.109	0.109	0.00	0.09%	0.04%
0	2	0.108	0.108	0.00	-0.06%	0.02%
0	3	0.109	0.109	0.00	-0.09%	0.04%
0	4	0.108	0.108	0.00	-0.06%	0.02%
30	5	0.109	0.109	0.00	0.11%	0.05%
30	6	0.108	0.108	0.00	-0.06%	0.02%
30	7	0.109	0.109	0.00	-0.03%	0.01%
30	8	0.108	0.108	0.00	0.32%	0.14%
30	9	0.109	0.109	0.00	0.03%	0.01%
30	10	0.109	0.109	0.00	-0.06%	0.02%
31	5a	0.109	0.109	0.00	-0.03%	0.01%
31	6a	0.108	0.108	0.00	-0.17%	0.07%
31	7a	0.109	0.109	0.00	-0.11%	0.05%
31	8a	0.108	0.108	0.00	0.06%	0.02%
31	9a	0.109	0.109	0.00	-0.06%	0.02%
31	10a	0.109	0.109	0.00	-0.14%	0.06%
Max	0.109	0.109	0.00	0.32%	0.14%	
Average	0.109	0.109	0.00	-0.02%	0.04%	
Min	0.108	0.108	0.00	-0.17%	0.01%	
Std Dev	0.001	0.001	0.00	0.12%	0.03%	

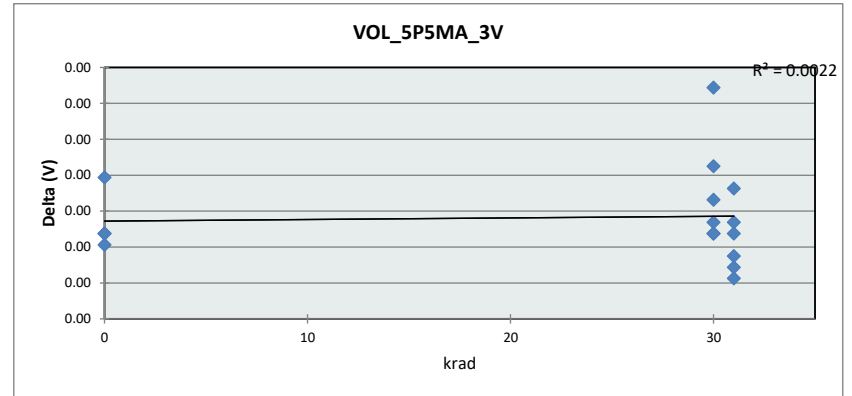

VOL_5P5MA_3V			
Units	V		
Max Limit	0.25		
Min Limit	-0.001		
krad	0	30	31
LL	-0.001	-0.001	-0.001
Min	0.108	0.108	0.108
Average	0.108	0.109	0.109
Max	0.109	0.109	0.109
UL	0.250	0.250	0.250

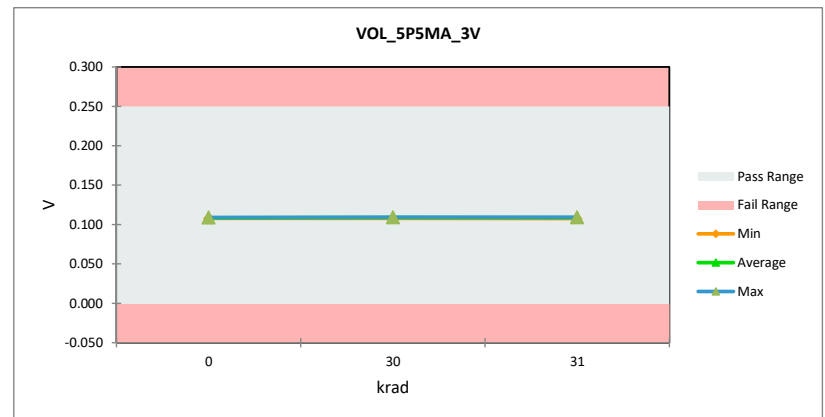

TID Report

SN54SC8T157-SEP

VOL_8MA_4P5V						
Units	V					
Max Limit	0.35					
Min Limit	-0.001					
krad	Serial #	PreTestHDR	PostTestHDR	Delta	Delta %	% of Limit Range
0	1	0.138	0.138	0.00	-0.05%	0.02%
0	2	0.136	0.136	0.00	0.07%	0.03%
0	3	0.137	0.137	0.00	-0.09%	0.04%
0	4	0.136	0.136	0.00	-0.02%	0.01%
30	5	0.138	0.138	0.00	-0.14%	0.05%
30	6	0.136	0.136	0.00	0.00%	0.00%
30	7	0.138	0.138	0.00	-0.18%	0.07%
30	8	0.136	0.136	0.00	0.14%	0.05%
30	9	0.138	0.138	0.00	-0.18%	0.07%
30	10	0.138	0.138	0.00	-0.20%	0.08%
31	5a	0.138	0.138	0.00	-0.05%	0.02%
31	6a	0.136	0.136	0.00	-0.02%	0.01%
31	7a	0.138	0.138	0.00	-0.14%	0.05%
31	8a	0.136	0.136	0.00	-0.02%	0.01%
31	9a	0.138	0.138	0.00	0.05%	0.02%
31	10a	0.138	0.138	0.00	-0.05%	0.02%
Max	0.138	0.138	0.00	0.14%	0.08%	
Average	0.137	0.137	0.00	-0.06%	0.03%	
Min	0.136	0.136	0.00	-0.20%	0.00%	
Std Dev	0.001	0.001	0.00	0.10%	0.03%	

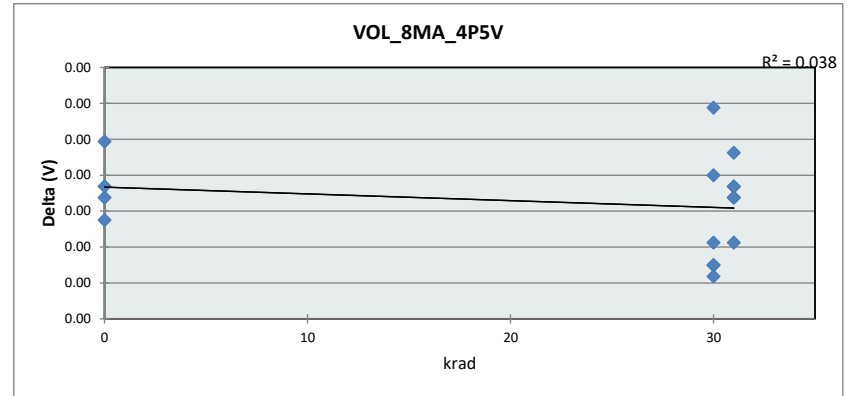

VOL_8MA_4P5V			
Units	V		
Max Limit	0.35		
Min Limit	-0.001		
krad	0	30	31
LL	-0.001	-0.001	-0.001
Min	0.136	0.136	0.136
Average	0.137	0.137	0.137
Max	0.138	0.138	0.138
UL	0.350	0.350	0.350

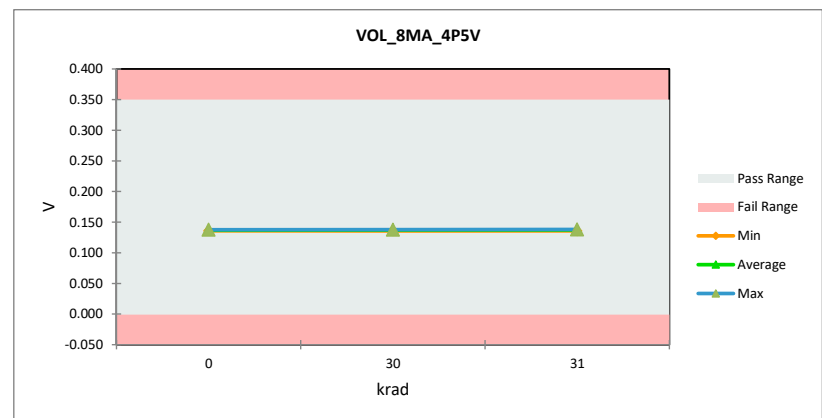

TID Report

SN54SC8T157-SEP

VOL_24MA_5P5V						
Units	V					
Max Limit	0.75					
Min Limit	-0.001					
krad	Serial #	PreTestHDR	PostTestHDR	Delta	Delta %	% of Limit Range
0	1	0.397	0.397	0.00	-0.05%	0.02%
0	2	0.393	0.393	0.00	0.06%	0.03%
0	3	0.397	0.397	0.00	-0.09%	0.05%
0	4	0.393	0.392	0.00	-0.15%	0.08%
30	5	0.398	0.397	0.00	-0.09%	0.05%
30	6	0.392	0.391	0.00	-0.15%	0.08%
30	7	0.398	0.397	0.00	-0.25%	0.13%
30	8	0.393	0.393	0.00	0.04%	0.02%
30	9	0.398	0.398	0.00	-0.09%	0.05%
30	10	0.397	0.397	0.00	-0.03%	0.02%
31	5a	0.398	0.397	0.00	-0.06%	0.03%
31	6a	0.392	0.391	0.00	-0.09%	0.05%
31	7a	0.398	0.397	0.00	-0.24%	0.13%
31	8a	0.393	0.393	0.00	-0.04%	0.02%
31	9a	0.398	0.398	0.00	-0.02%	0.01%
31	10a	0.397	0.398	0.00	0.05%	0.02%
Max	0.398	0.398	0.00	0.06%	0.13%	
Average	0.396	0.395	0.00	-0.07%	0.05%	
Min	0.392	0.391	0.00	-0.25%	0.01%	
Std Dev	0.003	0.003	0.00	0.09%	0.04%	

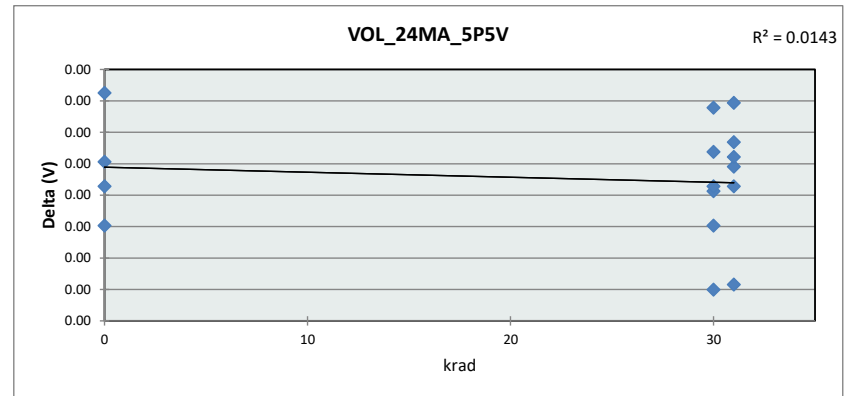

VOL_24MA_5P5V			
Units	V		
Max Limit	0.75		
Min Limit	-0.001		
krad	0	30	31
LL	-0.001	-0.001	-0.001
Min	0.392	0.391	0.391
Average	0.395	0.396	0.396
Max	0.397	0.398	0.398
UL	0.750	0.750	0.750

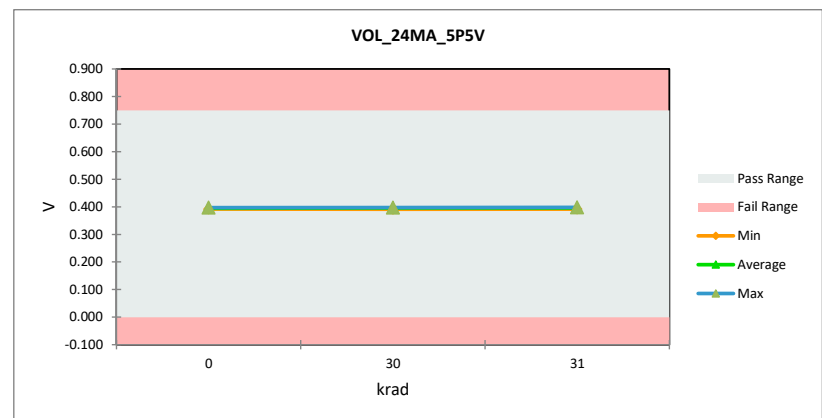

TID Report

SN54SC8T157-SEP

VOL_50UA_1P2V						
Units	V					
Max Limit	0.1					
Min Limit	-0.001					
krad	Serial #	PreTestHDR	PostTestHDR	Delta	Delta %	% of Limit Range
0	1	0.002	0.002	0.00	0.00%	0.00%
0	2	0.002	0.002	0.00	6.77%	0.15%
0	3	0.002	0.002	0.00	0.00%	0.00%
0	4	0.002	0.002	0.00	3.59%	0.08%
30	5	0.002	0.002	0.00	0.00%	0.00%
30	6	0.002	0.002	0.00	6.20%	0.14%
30	7	0.002	0.002	0.00	9.75%	0.22%
30	8	0.002	0.002	0.00	5.18%	0.12%
30	9	0.002	0.002	0.00	1.35%	0.03%
30	10	0.002	0.002	0.00	6.53%	0.15%
31	5a	0.002	0.002	0.00	0.75%	0.02%
31	6a	0.002	0.002	0.00	7.20%	0.16%
31	7a	0.002	0.002	0.00	4.98%	0.11%
31	8a	0.002	0.002	0.00	7.55%	0.17%
31	9a	0.002	0.003	0.00	8.91%	0.20%
31	10a	0.002	0.003	0.00	10.84%	0.25%
Max		0.002	0.003	0.00	10.84%	0.25%
Average		0.002	0.002	0.00	4.97%	0.11%
Min		0.002	0.002	0.00	0.00%	0.00%
Std Dev		0.000	0.000	0.00	3.64%	0.08%

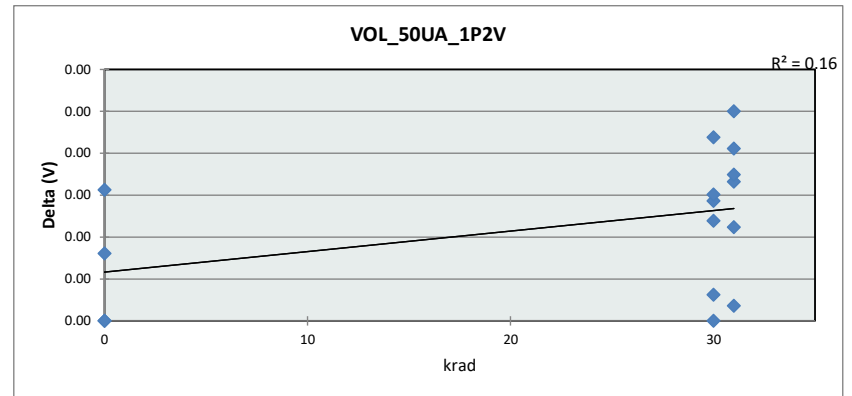

VOL_50UA_1P2V			
Units	V		
Max Limit	0.1		
Min Limit	-0.001		
krad	0	30	31
LL	-0.001	-0.001	-0.001
Min	0.002	0.002	0.002
Average	0.002	0.002	0.002
Max	0.002	0.002	0.003
UL	0.100	0.100	0.100

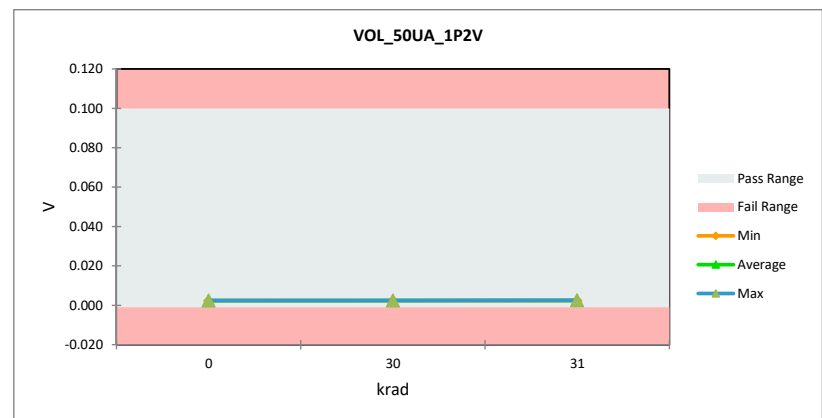

TID Report

SN54SC8T157-SEP

VOL_50UA_5P5V						
Units	V					
Max Limit	0.1					
Min Limit	-0.001					
krad	Serial #	PreTestHDR	PostTestHDR	Delta	Delta %	% of Limit Range
0	1	0.001	0.001	0.00	-9.18%	0.10%
0	2	0.001	0.001	0.00	-0.99%	0.01%
0	3	0.001	0.001	0.00	2.87%	0.03%
0	4	0.001	0.001	0.00	9.43%	0.09%
30	5	0.001	0.001	0.00	-1.23%	0.01%
30	6	0.001	0.001	0.00	8.87%	0.09%
30	7	0.001	0.001	0.00	0.00%	0.00%
30	8	0.001	0.001	0.00	32.86%	0.27%
30	9	0.001	0.001	0.00	12.57%	0.12%
30	10	0.001	0.001	0.00	6.49%	0.06%
31	5a	0.001	0.001	0.00	0.00%	0.00%
31	6a	0.001	0.001	0.00	0.00%	0.00%
31	7a	0.001	0.001	0.00	5.91%	0.06%
31	8a	0.001	0.001	0.00	11.19%	0.09%
31	9a	0.001	0.001	0.00	9.43%	0.09%
31	10a	0.001	0.001	0.00	11.59%	0.11%
Max	0.001	0.001	0.00	32.86%	0.27%	
Average	0.001	0.001	0.00	6.24%	0.07%	
Min	0.001	0.001	0.00	-9.18%	0.00%	
Std Dev	0.000	0.000	0.00	9.32%	0.07%	

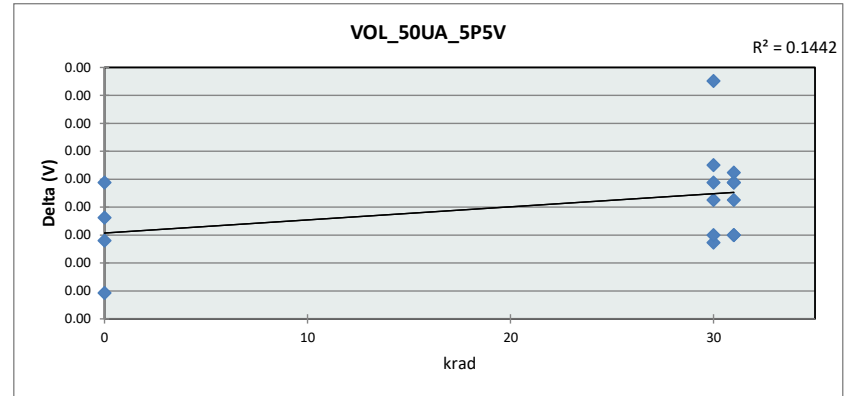

VOL_50UA_5P5V			
Units	V		
Max Limit	0.1		
Min Limit	-0.001		
krad	0	30	31
LL	-0.001	-0.001	-0.001
Min	0.001	0.001	0.001
Average	0.001	0.001	0.001
Max	0.001	0.001	0.001
UL	0.100	0.100	0.100

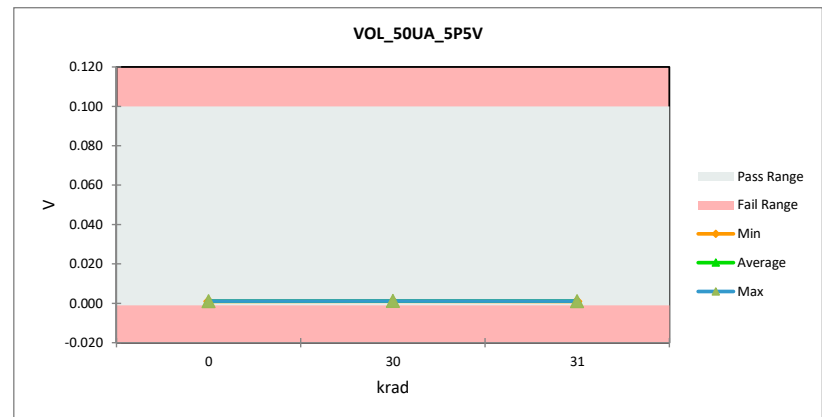

IMPORTANT NOTICE AND DISCLAIMER

TI PROVIDES TECHNICAL AND RELIABILITY DATA (INCLUDING DATA SHEETS), DESIGN RESOURCES (INCLUDING REFERENCE DESIGNS), APPLICATION OR OTHER DESIGN ADVICE, WEB TOOLS, SAFETY INFORMATION, AND OTHER RESOURCES "AS IS" AND WITH ALL FAULTS, AND DISCLAIMS ALL WARRANTIES, EXPRESS AND IMPLIED, INCLUDING WITHOUT LIMITATION ANY IMPLIED WARRANTIES OF MERCHANTABILITY, FITNESS FOR A PARTICULAR PURPOSE OR NON-INFRINGEMENT OF THIRD PARTY INTELLECTUAL PROPERTY RIGHTS.

These resources are intended for skilled developers designing with TI products. You are solely responsible for (1) selecting the appropriate TI products for your application, (2) designing, validating and testing your application, and (3) ensuring your application meets applicable standards, and any other safety, security, regulatory or other requirements.

These resources are subject to change without notice. TI grants you permission to use these resources only for development of an application that uses the TI products described in the resource. Other reproduction and display of these resources is prohibited. No license is granted to any other TI intellectual property right or to any third party intellectual property right. TI disclaims responsibility for, and you will fully indemnify TI and its representatives against, any claims, damages, costs, losses, and liabilities arising out of your use of these resources.

TI's products are provided subject to [TI's Terms of Sale](#) or other applicable terms available either on [ti.com](https://www.ti.com) or provided in conjunction with such TI products. TI's provision of these resources does not expand or otherwise alter TI's applicable warranties or warranty disclaimers for TI products.

TI objects to and rejects any additional or different terms you may have proposed.

Mailing Address: Texas Instruments, Post Office Box 655303, Dallas, Texas 75265
Copyright © 2025, Texas Instruments Incorporated