

# TPS7A87

## Dual, 500-mA, Low-Noise (3.8 $\mu$ V<sub>RMS</sub>), LDO Voltage Regulator

### 1 Features

- Two Independent LDO Channels
- Low Output Noise: 3.8  $\mu$ V<sub>RMS</sub> (10 Hz–100 kHz)
- Low Dropout: 100 mV<sub>MAX</sub> at 0.5 A
- Wide Input Voltage Range: 1.4 V to 6.5 V
- Wide Output Voltage Range: 0.8 V to 5.2 V
- High Power-Supply Ripple Rejection:
  - 75 dB at DC
  - 40 dB at 100 kHz
  - 40 dB at 1 MHz
- 1.0% Accuracy Over Line, Load, and Temperature
- Excellent Load Transient Response
- Adjustable Start-Up In-Rush Control
- Selectable Soft-Start Charging Current
- Independent Open-Drain Power-Good (PGx) Outputs
- Stable with a 10  $\mu$ F or Larger Ceramic Output Capacitor
- 4-mm x 4-mm, 20-Pin WQFN Package

### 2 Applications

- High-Speed Analog Circuits:
  - VCOs, ADCs, DACs, LVDSs
- Imaging: CMOS Sensors, Video ASICs
- Test and Measurement
- Instrumentation and Medical
- Professional Audio

### 3 Description

The TPS7A87 is a dual, low-noise (3.8  $\mu$ V<sub>RMS</sub>), low-dropout (LDO) voltage regulator capable of sourcing 500 mA per channel with only 100 mV of maximum dropout.

The TPS7A87 provides the flexibility of two independent LDOs and approximately 30% smaller solution size than two single-channel LDOs. Each output is adjustable with external resistors from 0.8 V to 5.2 V. The wide input-voltage range of the TPS7A87 supports operation as low as 1.4 V and up to 6.5 V.

With 1% output voltage accuracy (over line, load, and temperature) and soft-start capabilities to reduce in-rush current, the TPS7A87 is ideal for powering sensitive analog low-voltage devices [such as voltage-controlled oscillators (VCOs), analog-to-digital converters (ADCs), digital-to-analog converters (DACs), complementary metal oxide semiconductor (CMOS) sensors, and video application-specific integrated circuits (ASICs)].

The TPS7A87 is designed to power noise-sensitive components such as those found in instrumentation, medical, video, professional audio, test and measurement, and high-speed communication applications. The very low 3.8- $\mu$ V<sub>RMS</sub> output noise and wideband PSRR (40 dB at 1 MHz) minimizes phase noise and clock jitter. These features maximize the performance of clocking devices, ADCs, and DACs.

Typical Application Circuit

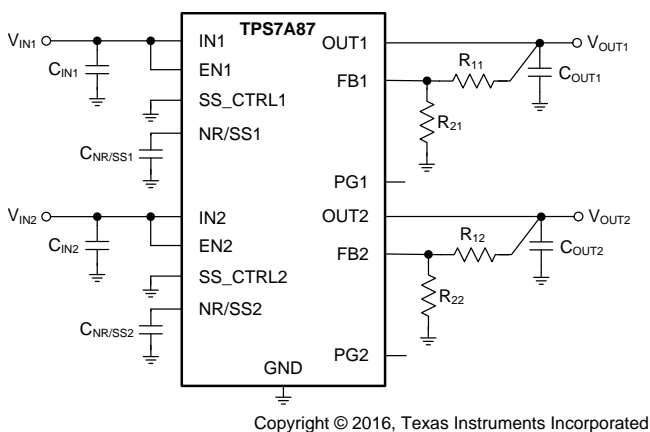

Device Information<sup>(1)</sup>

PART NUMBER	PACKAGE	BODY SIZE (NOM)
TPS7A87	WQFN (20)	4.00 mm x 4.00 mm

(1) For all available packages, see the orderable addendum at the end of the datasheet.

Powering the Signal Chain

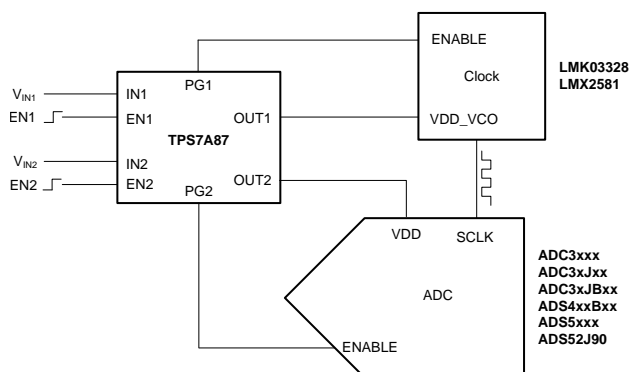

## Table of Contents

<b>1 Features</b> .....	<b>1</b>	<b>8 Application and Implementation</b> .....	<b>18</b>
<b>2 Applications</b> .....	<b>1</b>	8.1 Application Information.....	18
<b>3 Description</b> .....	<b>1</b>	8.2 Typical Application .....	32
<b>4 Revision History</b> .....	<b>2</b>	<b>9 Power Supply Recommendations</b> .....	<b>33</b>
<b>5 Pin Configuration and Functions</b> .....	<b>3</b>	<b>10 Layout</b> .....	<b>34</b>
<b>6 Specifications</b> .....	<b>4</b>	10.1 Layout Guidelines .....	34
6.1 Absolute Maximum Ratings .....	4	10.2 Layout Example .....	35
6.2 ESD Ratings.....	4	<b>11 Device and Documentation Support</b> .....	<b>36</b>
6.3 Recommended Operating Conditions.....	4	11.1 Device Support .....	36
6.4 Thermal Information .....	4	11.2 Documentation Support .....	36
6.5 Electrical Characteristics.....	5	11.3 Receiving Notification of Documentation Updates	36
6.6 Typical Characteristics.....	6	11.4 Community Resources.....	37
<b>7 Detailed Description</b> .....	<b>13</b>	11.5 Trademarks .....	37
7.1 Overview .....	13	11.6 Electrostatic Discharge Caution.....	37
7.2 Functional Block Diagram .....	13	11.7 Glossary .....	37
7.3 Feature Description.....	14	<b>12 Mechanical, Packaging, and Orderable</b>	
7.4 Device Functional Modes.....	17	<b>Information</b> .....	<b>37</b>

## 4 Revision History

NOTE: Page numbers for previous revisions may differ from page numbers in the current version.

Changes from Original (March 2016) to Revision A	Page
• Released to production.....	1

## 5 Pin Configuration and Functions

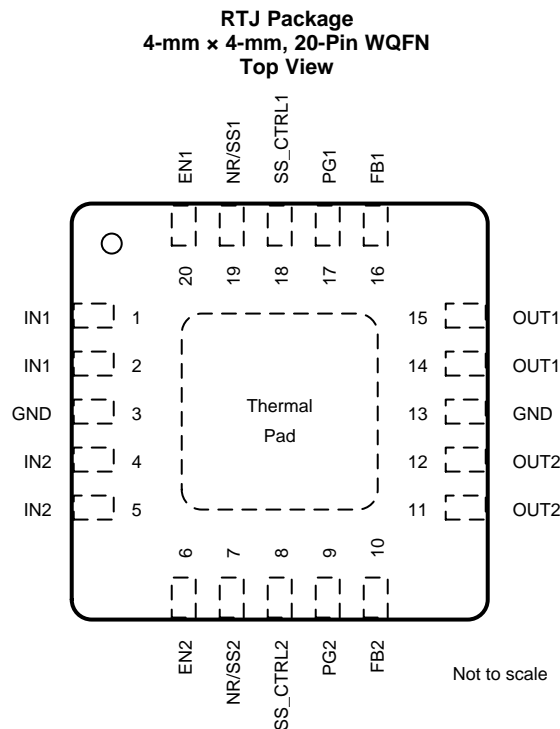

### Pin Functions

PIN			DESCRIPTION
NAME	NO.	I/O	
EN1	20	I	Enable pin for each channel. These pins turn the regulator on and off. If $V_{ENx}^{(1)} \geq V_{IH(ENx)}$ , then the regulator is enabled. If $V_{ENx} \leq V_{IL(ENx)}$ , then the regulator is disabled. The ENx pin must be connected to INx if the enable function is not used.
EN2	6		
FB1	16	I	Feedback pin connected to the error amplifier. Although not required, a 10-nF feed-forward capacitor from FBx to OUTx (as close to the device as possible) is recommended to maximize ac performance. The use of a feed-forward capacitor can disrupt PGx (power good) functionality. See the <a href="#">Feed-Forward Capacitor (C<sub>FFx</sub>)</a> and <a href="#">Setting the Output Voltage (Adjustable Operation)</a> sections for more details.
FB2	10		
GND	3, 13	—	Ground pin. These pins must be connected to ground, the thermal pad, and each other with a low-impedance connection.
IN1	1, 2	I	Input supply pin for LDO 1. A 10- $\mu$ F or greater input capacitor is required. Place the input capacitor as close to the input as possible.
IN2	4, 5	I	Input supply pin for LDO 2. A 10- $\mu$ F or greater input capacitor is required. Place the input capacitor as close to the input as possible.
NR/SS1	19	—	Noise-reduction and soft-start pin for each channel. Connecting an external capacitor between this pin and ground reduces reference voltage noise and also enables the soft-start function. Although not required, a 10 nF or larger capacitor is recommended to be connected from NR/SSx to GND (as close to the pin as possible) to maximize ac performance. See the <a href="#">Noise-Reduction and Soft-Start Capacitor (C<sub>NR/SSx</sub>)</a> section for more details.
NR/SS2	7		
OUT1	14, 15	O	Regulated output for LDO 1. A 10- $\mu$ F or larger ceramic capacitor (5 $\mu$ F or greater of effective capacitance) from OUTx to ground is required for stability and must be placed as close to the output as possible. Minimize the impedance from the OUT1 pin to the load. See the <a href="#">Input and Output Capacitor (C<sub>INx</sub> and C<sub>OUTx</sub>)</a> section for more details.
OUT2	11, 12	O	Regulated output for LDO 2. A 10- $\mu$ F or larger ceramic capacitor (5 $\mu$ F or greater of effective capacitance) from OUTx to ground is required for stability and must be placed as close to the output as possible. Minimize the impedance from the OUT2 pin to the load. See the <a href="#">Input and Output Capacitor (C<sub>INx</sub> and C<sub>OUTx</sub>)</a> section for more details.
PG1	17	O	Open-drain power-good indicator pins for the LDO 1 and LDO 2 output voltages. A 10-k $\Omega$ to 100-k $\Omega$ external pullup resistor is required. These pins can be left floating or connected to GND if not used. The use of a feed-forward capacitor can disrupt power-good functionality. See the <a href="#">Feed-Forward Capacitor (C<sub>FFx</sub>)</a> section for more details.
PG2	9		
SS_CTRL1	18	I	Soft-start control pin for each channel. Connect these pins either to GND or INx to allow normal or fast charging of the NR/SSx capacitor. If a C <sub>NR/SSx</sub> capacitor is not used, SS_CTRLx must be connected to GND to avoid output overshoot.
SS_CTRL2	8		
Thermal pad		—	Connect the thermal pad to a large-area ground plane. The thermal pad is internally connected to GND.

(1) Lowercase x indicates that the specification under consideration applies to both channel 1 and channel 2, one channel at a time.

## 6 Specifications

### 6.1 Absolute Maximum Ratings

over operating junction temperature range and all voltages with respect to GND (unless otherwise noted)<sup>(1)</sup>

		MIN	MAX	UNIT
Voltage	INx, PGx, ENx <sup>(2)</sup>	-0.3	7.0	V
	INx, PGx, ENx (5% duty cycle, pulse duration = 200 μs)	-0.3	7.5	
	OUTx	-0.3	V <sub>INx</sub> + 0.3 <sup>(3)</sup>	
	SS_CTRLx	-0.3	V <sub>INx</sub> + 0.3 <sup>(3)</sup>	
	NR/SSx, FBx <sup>(2)</sup>	-0.3	3.6	
Current	OUTx <sup>(2)</sup>	Internally limited		A
	PGx (sink current into device) <sup>(2)</sup>	5		mA
Temperature	Operating junction, T <sub>J</sub>	-55	150	°C
	Storage, T <sub>stg</sub>	-55	150	

- (1) Stresses beyond those listed under *Absolute Maximum Ratings* may cause permanent damage to the device. These are stress ratings only, which do not imply functional operation of the device at these or any other conditions beyond those indicated under *Recommended Operating Conditions*. Exposure to absolute-maximum-rated conditions for extended periods may affect device reliability.
- (2) Lowercase x indicates that the specification under consideration applies to both channel 1 and channel 2, one channel at a time.
- (3) The absolute maximum rating is V<sub>INx</sub> + 0.3 V or 7.0 V, whichever is smaller.

### 6.2 ESD Ratings

		VALUE	UNIT
V <sub>(ESD)</sub>	Electrostatic discharge	Human body model (HBM), per ANSI/ESDA/JEDEC JS-001 <sup>(1)</sup>	±2000
		Charged device model (CDM), per JEDEC specification JESD22-C101 <sup>(2)</sup>	±500

- (1) JEDEC document JEP155 states that 500-V HBM allows safe manufacturing with a standard ESD control process.
- (2) JEDEC document JEP157 states that 250-V CDM allows safe manufacturing with a standard ESD control process.

### 6.3 Recommended Operating Conditions

over operating junction temperature range (unless otherwise noted)

		MIN	MAX	UNIT
V <sub>INx</sub>	Input supply voltage range	1.4	6.5	V
V <sub>OUTx</sub>	Output voltage range	0.8 – 1%	5.2 + 1%	V
I <sub>OUTx</sub>	Output current	0	500	mA
C <sub>INx</sub>	Input capacitor, each input	10		μF
C <sub>OUTx</sub>	Output capacitor	10		μF
C <sub>NR/SSx</sub>	Noise-reduction capacitor		1	μF
R <sub>PGx</sub>	Power-good pullup resistance	10	100	kΩ
T <sub>J</sub>	Junction temperature range	-40	125	°C

### 6.4 Thermal Information

THERMAL METRIC <sup>(1)</sup>		TPS7A87	UNIT
		RTJ (WQFN)	
		20 PINS	
R <sub>θJA</sub>	Junction-to-ambient thermal resistance	33	°C/W
R <sub>θJC(top)</sub>	Junction-to-case (top) thermal resistance	26.8	°C/W
R <sub>θJB</sub>	Junction-to-board thermal resistance	8.0	°C/W
ψ <sub>JT</sub>	Junction-to-top characterization parameter	0.3	°C/W
ψ <sub>JB</sub>	Junction-to-board characterization parameter	8.0	°C/W
R <sub>θJC(bot)</sub>	Junction-to-case (bottom) thermal resistance	2.4	°C/W

- (1) For more information about traditional and new thermal metrics, see the [Semiconductor and IC Package Thermal Metrics application report](#) (SPRA953).

## 6.5 Electrical Characteristics

over operating temperature range ( $T_J = -40^{\circ}\text{C}$  to  $+125^{\circ}\text{C}$ ),  $V_{INx} = 1.4\text{ V}$  or  $V_{OUTx(TARGET)} + 0.2\text{ V}$  (whichever is greater),  $V_{OUTx(TARGET)} = 0.8\text{ V}$ ,  $I_{OUTx} = 50\text{ mA}$ ,  $V_{ENx} = 1.4\text{ V}$ ,  $C_{OUTx} = 10\text{ }\mu\text{F}$ ,  $C_{NR/SSx} = 0\text{ nF}$ ,  $C_{FFx} = 0\text{ nF}$ ,  $SS\_CTRLx = \text{GND}$ , PGx pin pulled up to  $V_{INx}$  with  $100\text{ k}\Omega$ , and for each channel (unless otherwise noted); typical values are at  $T_J = 25^{\circ}\text{C}$

PARAMETER	TEST CONDITIONS	MIN	TYP	MAX	UNIT	
$V_{INx}^{(1)}$	Input supply voltage range	1.4		6.5	V	
$V_{REF}$	Reference voltage		0.8		V	
$V_{UVLOx}$	Input supply UVLOx	$V_{INx}$ rising	1.31	1.39	V	
$V_{UVLOx(HYS)}$	$V_{UVLOx}$ hysteresis	$V_{INx}$ falling hysteresis	290		mV	
$V_{OUTx}$	Output voltage range	0.8 – 1%		5.2 + 1%	V	
	$V_{OUTx}$ accuracy <sup>(2)</sup>	$0.8\text{ V} \leq V_{OUTx} \leq 5.2\text{ V}$ , $5\text{ mA} \leq I_{OUTx} \leq 0.5\text{ A}$		1.0%		
$\Delta V_{OUTx(\Delta V_{INx})}$	Line regulation	$I_{OUTx} = 5\text{ mA}$ , $1.4\text{ V} \leq V_{INx} \leq 6.5\text{ V}$	0.003		%/V	
$\Delta V_{OUTx(\Delta I_{OUTx})}$	Load regulation	$5\text{ mA} \leq I_{OUTx} \leq 0.5\text{ A}$	0.03		%/A	
$V_{DO}$	Dropout voltage	$1.4\text{ V} \leq V_{INx} \leq 5.3\text{ V}$ $I_{OUTx} = 0.5\text{ A}$ , $V_{FBx} = 0.8\text{ V} - 3\%$		100	mV	
$I_{LIM}$	Output current limit	$V_{OUTx}$ forced at $0.9 \times V_{OUTx(TARGET)}$	0.8	1.1	1.5	A
$I_{GND}$	GND pin current	Both channels enabled, per channel, $V_{INx} = 6.5\text{ V}$ , $I_{OUTx} = 5\text{ mA}$	2.1	3.5	mA	
		Both channels enabled, per channel, $V_{INx} = 1.4\text{ V}$ , $I_{OUTx} = 0.5\text{ A}$		4		
$I_{SDN}$	Shutdown GND pin current	Both channels shutdown, per channel, PGx = (open), $V_{INx} = 6.5\text{ V}$ , $V_{ENx} = 0.4\text{ V}$	0.1	15	$\mu\text{A}$	
$I_{ENx}$	ENx pin current	$V_{INx} = 6.5\text{ V}$ , $0\text{ V} \leq V_{ENx} \leq 6.5\text{ V}$	-0.2	0.2	$\mu\text{A}$	
$V_{IL(ENx)}$	ENx pin low-level input voltage (device disabled)		0	0.4	V	
$V_{IH(ENx)}$	ENx pin high-level input voltage (device enabled)		1.1	6.5	V	
$I_{SS\_CTRLx}$	SS_CTRLx pin current	$V_{INx} = 6.5\text{ V}$ , $0\text{ V} \leq V_{SS\_CTRLx} \leq 6.5\text{ V}$	-0.2	0.2	$\mu\text{A}$	
$V_{IT(PGx)}$	PGx pin threshold	For PGx transitioning low with falling $V_{OUTx}$ , expressed as a percentage of $V_{OUTx(TARGET)}$	82%	88.9%	93%	
$V_{hys(PGx)}$	PGx pin hysteresis	For PGx transitioning high with rising $V_{OUTx}$ , expressed as a percentage of $V_{OUTx(TARGET)}$	1%			
$V_{OL(PGx)}$	PGx pin low-level output voltage	$V_{OUTx} < V_{IT(PGx)}$ , $I_{PGx} = -1\text{ mA}$ (current into device)		0.4	V	
$I_{lkg(PGx)}$	PGx pin leakage current	$V_{OUTx} > V_{IT(PGx)}$ , $V_{PGx} = 6.5\text{ V}$		1	$\mu\text{A}$	
$I_{NR/SSx}$	NR/SSx pin charging current	$V_{NR/SSx} = \text{GND}$ , $1.4\text{ V} \leq V_{INx} \leq 6.5\text{ V}$ , $V_{SS\_CTRLx} = \text{GND}$	4.0	6.2	9.0	$\mu\text{A}$
		$V_{NR/SSx} = \text{GND}$ , $1.4\text{ V} \leq V_{INx} \leq 6.5\text{ V}$ , $V_{SS\_CTRLx} = V_{INx}$	65	100	150	
$I_{FBx}$	FBx pin leakage current	$V_{INx} = 6.5\text{ V}$ , $V_{FBx} = 0.8\text{ V}$	-100	100	nA	
PSRR	Power-supply rejection ratio	$f = 500\text{ kHz}$ , $V_{INx} = 3.8\text{ V}$ , $V_{OUTx} = 3.3\text{ V}$ , $I_{OUTx} = 250\text{ mA}$ , $C_{NR/SSx} = 10\text{ nF}$ , $C_{FFx} = 10\text{ nF}$	40		dB	
$V_n$	Output noise voltage	BW = 10 Hz to 100 kHz, $V_{INx} = 1.8\text{ V}$ , $V_{OUTx} = 0.8\text{ V}$ , $I_{OUTx} = 0.5\text{ A}$ , $C_{NR/SSx} = 1\text{ }\mu\text{F}$ , $C_{FFx} = 100\text{ nF}$	3.8		$\mu\text{V}_{RMS}$	
	Noise spectral density	$f = 10\text{ kHz}$ , $V_{INx} = 1.8\text{ V}$ , $V_{OUTx} = 0.8\text{ V}$ , $I_{OUTx} = 0.5\text{ A}$ , $C_{NR/SSx} = 10\text{ nF}$ , $C_{FFx} = 10\text{ nF}$	11		$\text{nV}/\sqrt{\text{Hz}}$	
$R_{diss}$	Output active discharge resistance	$V_{ENx} = \text{GND}$	250		$\Omega$	
$T_{sdx}$	Thermal shutdown temperature	Shutdown, temperature increasing	160		$^{\circ}\text{C}$	
		Reset, temperature decreasing	140			

(1) Lowercase x indicates that the specification under consideration applies to both channel 1 and channel 2.

(2) When the device is connected to external feedback resistors at the FBx pins, external resistor tolerances are not included.

## 6.6 Typical Characteristics

at  $T_J = 25^\circ\text{C}$ ,  $1.4\text{ V} \leq V_{INX} < 6.5\text{ V}$ ,  $V_{INX} \geq V_{OUTX(TARGET)} + 0.3\text{ V}$ ,  $V_{OUTX} = 0.8\text{ V}$ ,  $SS\_CTRLX = \text{GND}$ ,  $I_{OUTX} = 5\text{ mA}$ ,  $V_{ENX} = 1.1\text{ V}$ ,  $C_{OUTX} = 10\text{ }\mu\text{F}$ ,  $C_{NR/SSX} = 0\text{ nF}$ ,  $C_{FFX} = 0\text{ nF}$ , PGX pin pulled up to  $V_{OUTX}$  with  $100\text{ k}\Omega$ , and  $SS\_CTRLX = \text{GND}$  (unless otherwise noted)

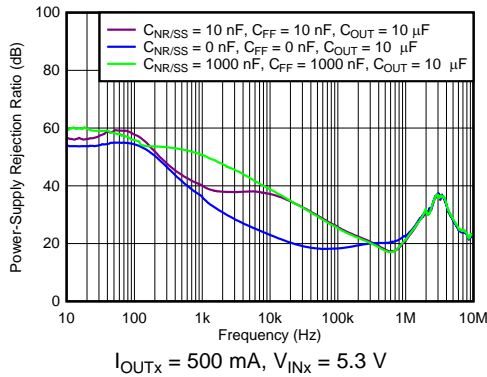

Figure 1. Power-Supply Rejection Ratio at  $V_{OUTX} = 5.0\text{ V}$

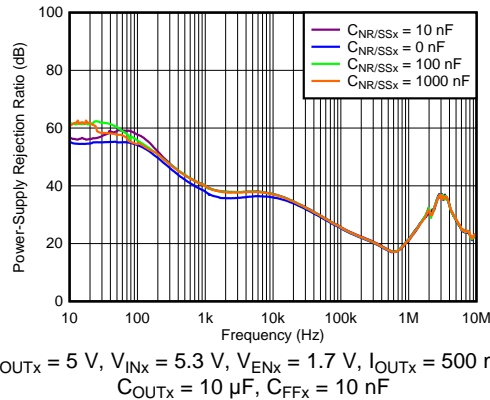

Figure 2. Power-Supply Rejection Ratio vs Frequency and  $C_{NR/SSX}$

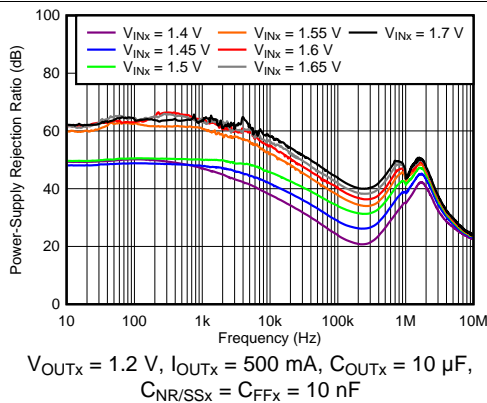

Figure 3. Power-Supply Rejection Ratio vs Frequency and Input Voltage

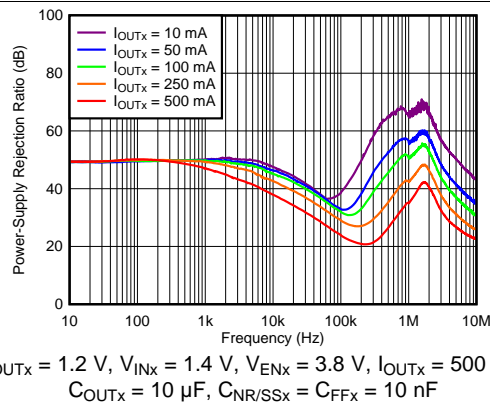

Figure 4. Power-Supply Rejection Ratio vs Frequency and Output Current

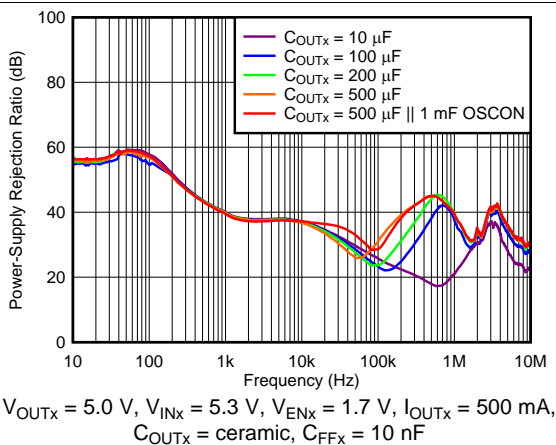

Figure 5. Power-Supply Rejection Ratio vs Frequency and Output Capacitance

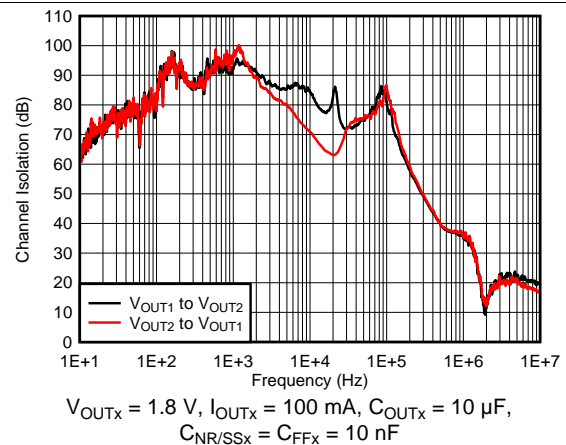

Figure 6. Channel-to-Channel Output Voltage Isolation vs Frequency

Typical Characteristics (continued)

at  $T_J = 25^\circ\text{C}$ ,  $1.4\text{ V} \leq V_{INX} < 6.5\text{ V}$ ,  $V_{INX} \geq V_{OUTX(TARGET)} + 0.3\text{ V}$ ,  $V_{OUTX} = 0.8\text{ V}$ ,  $SS\_CTRLX = \text{GND}$ ,  $I_{OUTX} = 5\text{ mA}$ ,  $V_{ENX} = 1.1\text{ V}$ ,  $C_{OUTX} = 10\text{ }\mu\text{F}$ ,  $C_{NR/SSX} = 0\text{ nF}$ ,  $C_{FFX} = 0\text{ nF}$ ,  $PGX$  pin pulled up to  $V_{OUTX}$  with  $100\text{ k}\Omega$ , and  $SS\_CTRLX = \text{GND}$  (unless otherwise noted)

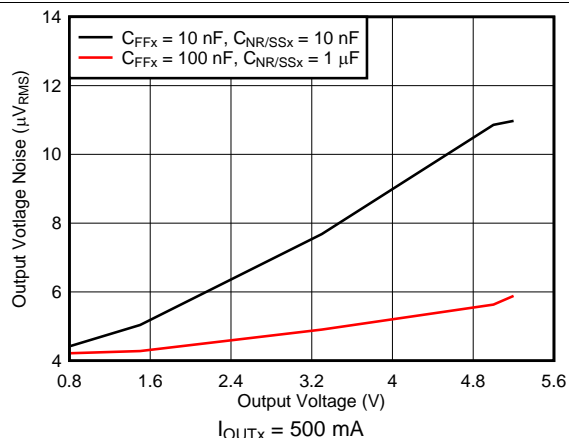

Figure 7. Output Noise vs Output Voltage

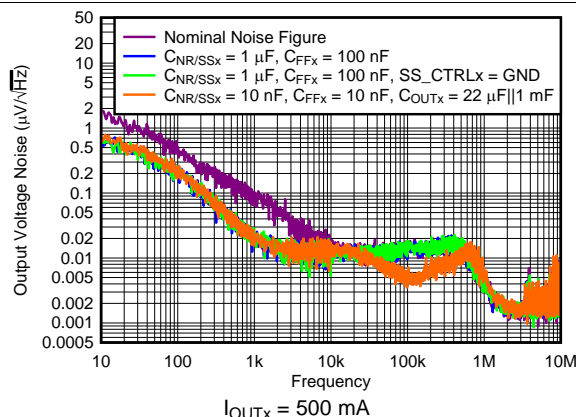
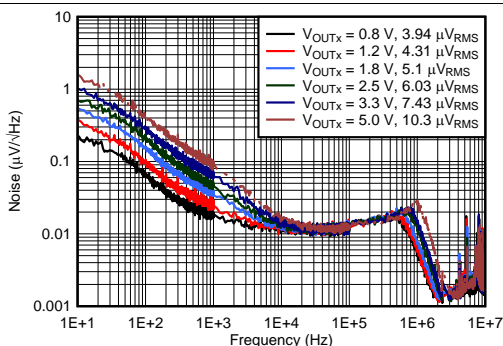
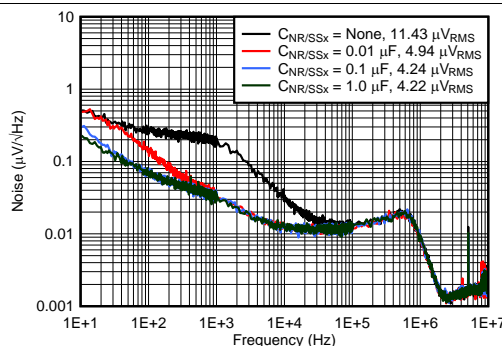

Figure 8. Output Noise at  $V_{OUTX} = 5\text{ V}$



$V_{INX} = V_{OUTX} + 1.0\text{ V}$ ,  $I_{OUTX} = 500\text{ mA}$ ,  $V_{RMS\ BW} = 10\text{ Hz to }100\text{ kHz}$ ,  $C_{OUTX} = 10\text{ }\mu\text{F}$ ,  $C_{NR/SSX} = C_{FFX} = 10\text{ nF}$

Figure 9. Noise vs Frequency and Output Voltage



$V_{INX} = 1.7\text{ V}$ ,  $V_{OUTX} = 1.2\text{ V}$ ,  $I_{OUTX} = 500\text{ mA}$ ,  $V_{RMS\ BW} = 10\text{ Hz to }100\text{ kHz}$ ,  $C_{OUTX} = 10\text{ }\mu\text{F}$ ,  $C_{FFX} = 10\text{ nF}$

Figure 10. Noise vs Frequency and  $C_{NR/SSX}$

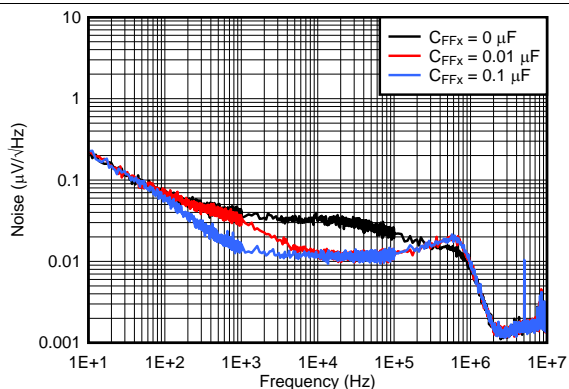

$V_{INX} = 3.8\text{ V}$ ,  $V_{OUTX} = 3.3\text{ V}$ ,  $I_{OUTX} = 500\text{ mA}$ ,  $V_{RMS\ BW} = 10\text{ Hz to }100\text{ kHz}$ ,  $C_{OUTX} = 10\text{ }\mu\text{F}$ ,  $C_{NR/SSX} = 10\text{ nF}$

Figure 11. Noise vs Frequency and  $C_{FFX}$

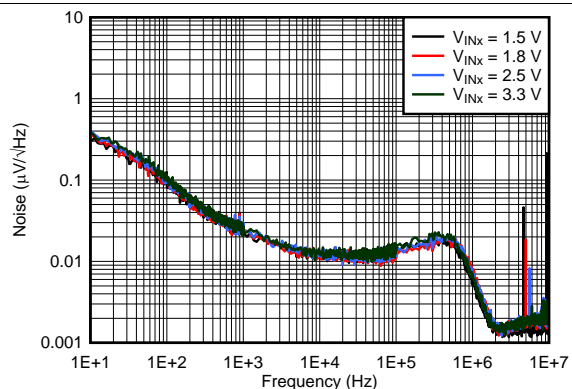

$V_{OUTX} = 1.2\text{ V}$ ,  $I_{OUTX} = 500\text{ mA}$ ,  $C_{OUTX} = 10\text{ }\mu\text{F}$ ,  $C_{NR/SSX} = 10\text{ nF}$

Figure 12. Noise vs Frequency and  $V_{INX}$

Typical Characteristics (continued)

at  $T_J = 25^\circ\text{C}$ ,  $1.4\text{ V} \leq V_{\text{INX}} < 6.5\text{ V}$ ,  $V_{\text{INX}} \geq V_{\text{OUTX(TARGET)}} + 0.3\text{ V}$ ,  $V_{\text{OUTX}} = 0.8\text{ V}$ ,  $\text{SS\_CTRLX} = \text{GND}$ ,  $I_{\text{OUTX}} = 5\text{ mA}$ ,  $V_{\text{ENX}} = 1.1\text{ V}$ ,  $C_{\text{OUTX}} = 10\text{ }\mu\text{F}$ ,  $C_{\text{NR/SSX}} = 0\text{ nF}$ ,  $C_{\text{FFX}} = 0\text{ nF}$ , PGx pin pulled up to  $V_{\text{OUTX}}$  with  $100\text{ k}\Omega$ , and  $\text{SS\_CTRLX} = \text{GND}$  (unless otherwise noted)

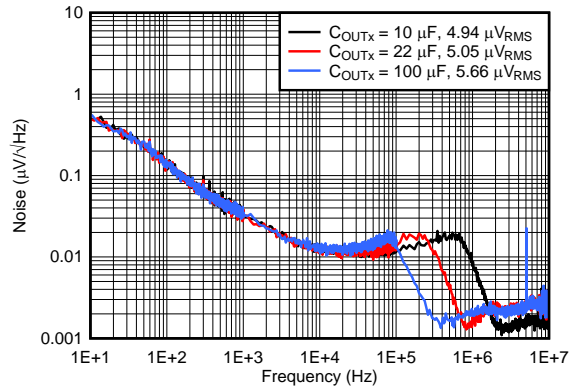

$V_{\text{OUTX}} = 1.8\text{ V}$ ,  $I_{\text{OUTX}} = 500\text{ mA}$ ,  $V_{\text{RMS BW}} = 10\text{ Hz to } 100\text{ kHz}$ ,  $C_{\text{FFX}} = 0.01\text{ }\mu\text{F}$

Figure 13. Noise vs Frequency and  $C_{\text{OUTX}}$

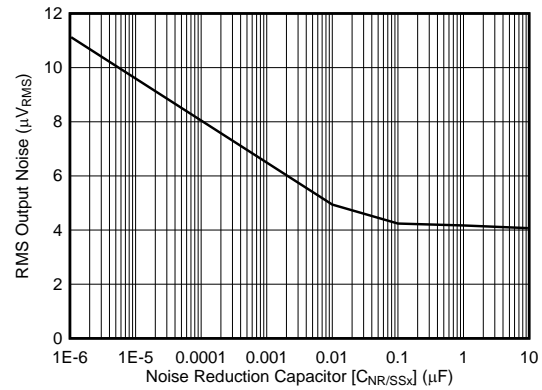

$V_{\text{OUTX}} = 1.8\text{ V}$ ,  $I_{\text{OUTX}} = 500\text{ mA}$ ,  $C_{\text{FFX}} = 0.01\text{ }\mu\text{F}$ ,  $\text{BW} = 10\text{ Hz to } 100\text{ kHz}$

Figure 14. RMS Output Noise vs  $C_{\text{NR/SSX}}$

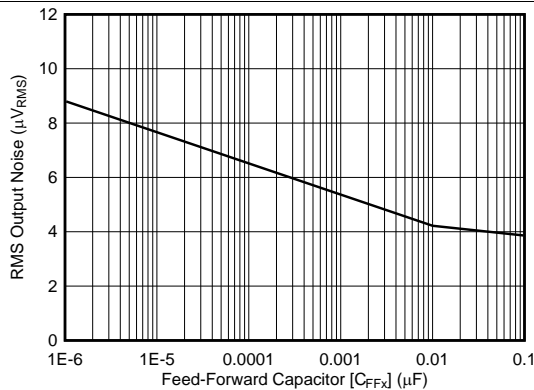

$V_{\text{OUTX}} = 1.8\text{ V}$ ,  $I_{\text{OUTX}} = 500\text{ mA}$ ,  $C_{\text{NR/SSX}} = 1\text{ }\mu\text{F}$ ,  $\text{BW} = 10\text{ Hz to } 100\text{ kHz}$

Figure 15. RMS Output Noise vs  $C_{\text{FFX}}$

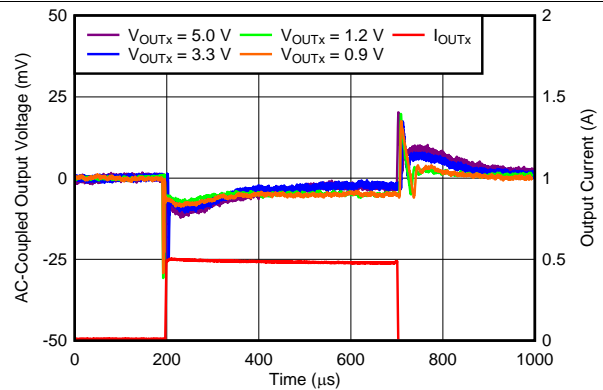

$V_{\text{INX}} = V_{\text{OUTX}} + 0.3\text{ V}$ ,  $I_{\text{OUTX}} = 10\text{ mA to } 500\text{ mA}$ ,  $C_{\text{OUTX}} = 10\text{ }\mu\text{F}$ ,  $C_{\text{FFX}} = C_{\text{NR/SSX}} = 10\text{ nF}$

Figure 16. Load Transient Response vs  $V_{\text{OUTX}}$

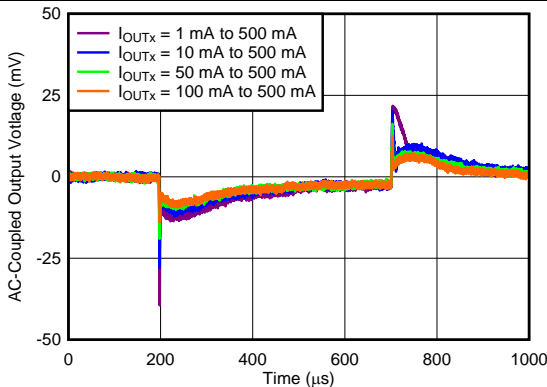

$V_{\text{INX}} = 5.3\text{ V}$ ,  $C_{\text{OUTX}} = 10\text{ }\mu\text{F}$ ,  $C_{\text{FFX}} = C_{\text{NR/SSX}} = 10\text{ nF}$

Figure 17. Load Transient Response vs DC Load

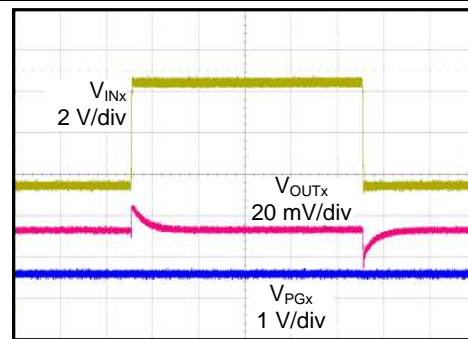

Time (200  $\mu\text{s/div}$ )  
 $V_{\text{INX}} = 1.4\text{ V to } 6.5\text{ V to } 1.4\text{ V at } 2\text{ V}/\mu\text{s}$ ,  $V_{\text{OUTX}} = 0.8\text{ V}$ ,  $I_{\text{OUTX}} = 500\text{ mA}$ ,  $C_{\text{NR/SSX}} = C_{\text{FFX}} = 10\text{ nF}$

Figure 18. Line Transient



### Typical Characteristics (continued)

at  $T_J = 25^\circ\text{C}$ ,  $1.4\text{ V} \leq V_{\text{IN}x} < 6.5\text{ V}$ ,  $V_{\text{IN}x} \geq V_{\text{OUT}x(\text{TARGET})} + 0.3\text{ V}$ ,  $V_{\text{OUT}x} = 0.8\text{ V}$ ,  $\text{SS\_CTRL}x = \text{GND}$ ,  $I_{\text{OUT}x} = 5\text{ mA}$ ,  $V_{\text{EN}x} = 1.1\text{ V}$ ,  $C_{\text{OUT}x} = 10\text{ }\mu\text{F}$ ,  $C_{\text{NR/SS}x} = 0\text{ nF}$ ,  $C_{\text{FF}x} = 0\text{ nF}$ ,  $\text{PG}x$  pin pulled up to  $V_{\text{OUT}x}$  with  $100\text{ k}\Omega$ , and  $\text{SS\_CTRL}x = \text{GND}$  (unless otherwise noted)

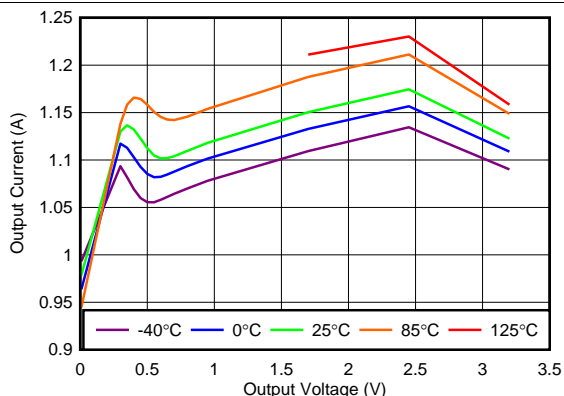

$V_{\text{IN}x} = 3.4\text{ V}$ ,  $V_{\text{OUT}x} = 3.3\text{ V}$ , 125°C curve truncated because of device entering thermal shutdown

Figure 19. Current Limit Foldback

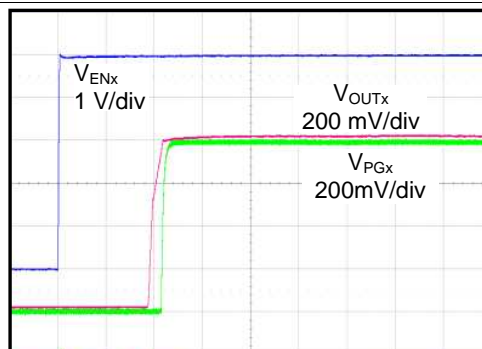

Time (50  $\mu\text{s}/\text{div}$ )  
 $V_{\text{IN}x} = 1.4\text{ V}$

Figure 20. Start-Up (SS\_CTRLx = GND, C\_NR/SSx = 0 nF)

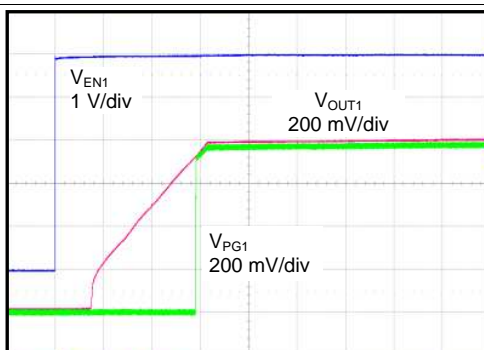

Time (500  $\mu\text{s}/\text{div}$ )  
 $V_{\text{IN}x} = 1.4\text{ V}$

Figure 21. Start-Up (SS\_CTRLx = GND, C\_NR/SSx = 10 nF)

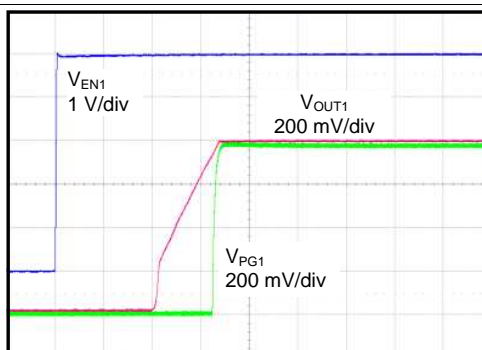

Time (50  $\mu\text{s}/\text{div}$ )  
 $V_{\text{IN}x} = 1.4\text{ V}$

Figure 22. Start-Up (SS\_CTRLx = V\_INx, C\_NR/SSx = 10 nF)

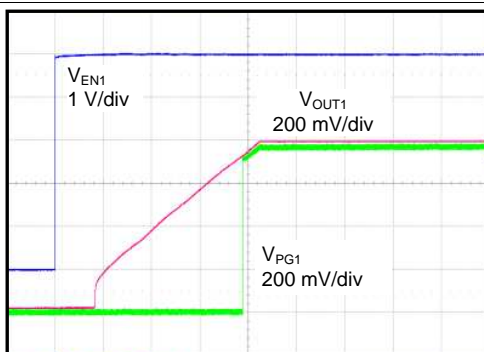

Time (2  $\text{ms}/\text{div}$ )  
 $V_{\text{IN}x} = 1.4\text{ V}$

Figure 23. Start-Up (SS\_CTRLx = V\_INx, C\_NR/SSx = 1  $\mu\text{F}$ )

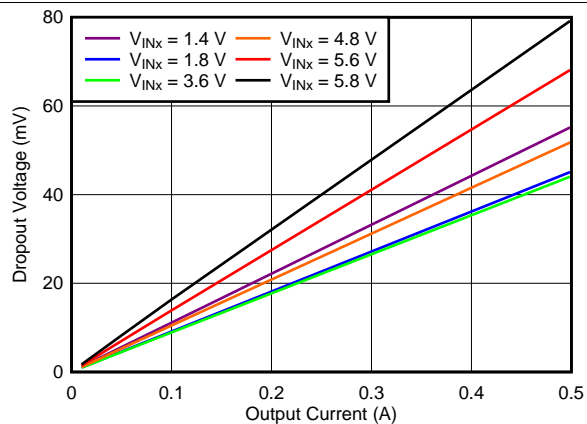

Figure 24. Dropout Voltage vs Output Current

### Typical Characteristics (continued)

at  $T_J = 25^\circ\text{C}$ ,  $1.4\text{ V} \leq V_{\text{INx}} < 6.5\text{ V}$ ,  $V_{\text{INx}} \geq V_{\text{OUTx(TARGET)}} + 0.3\text{ V}$ ,  $V_{\text{OUTx}} = 0.8\text{ V}$ ,  $\text{SS\_CTRLx} = \text{GND}$ ,  $I_{\text{OUTx}} = 5\text{ mA}$ ,  $V_{\text{ENx}} = 1.1\text{ V}$ ,  $C_{\text{OUTx}} = 10\ \mu\text{F}$ ,  $C_{\text{NR/SSx}} = 0\text{ nF}$ ,  $C_{\text{FFx}} = 0\text{ nF}$ , PGx pin pulled up to  $V_{\text{OUTx}}$  with  $100\text{ k}\Omega$ , and  $\text{SS\_CTRLx} = \text{GND}$  (unless otherwise noted)

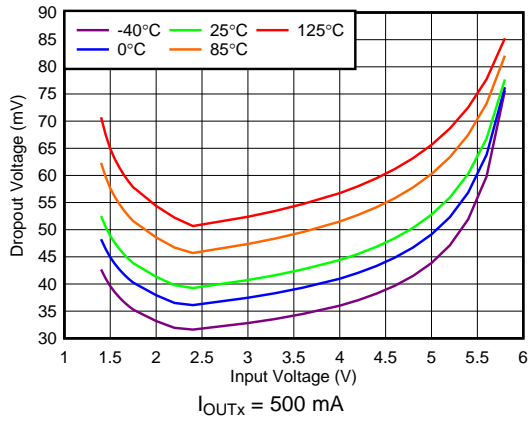

Figure 25. Dropout Voltage vs Input Voltage

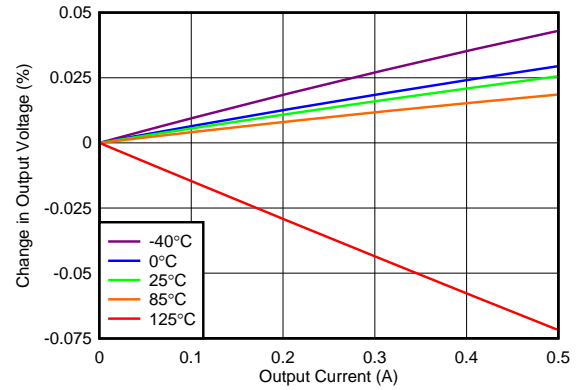

Figure 26. Load Regulation ( $V_{\text{OUTx}} = 1.2\text{ V}$ )

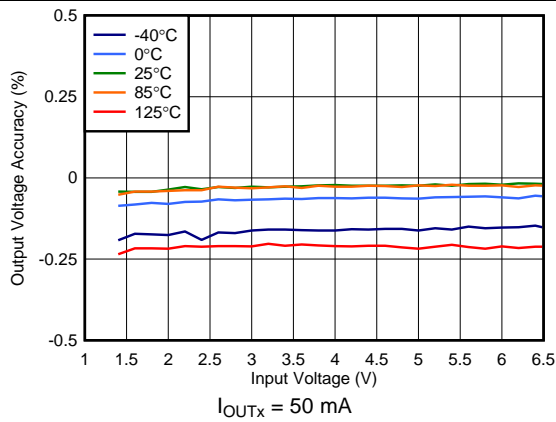

Figure 27. Line Regulation ( $V_{\text{OUTx}} = 0.8\text{ V}$ )

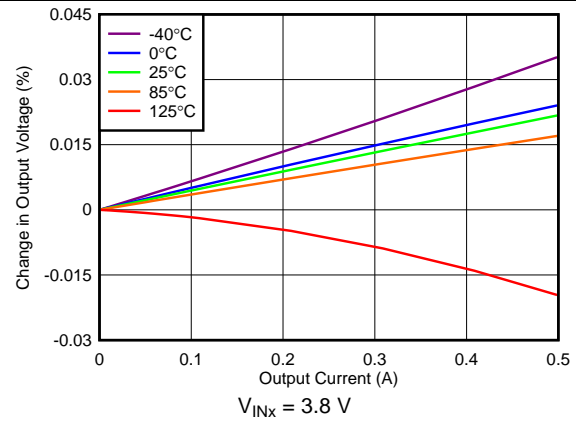

Figure 28. Load Regulation ( $V_{\text{OUTx}} = 3.3\text{ V}$ )

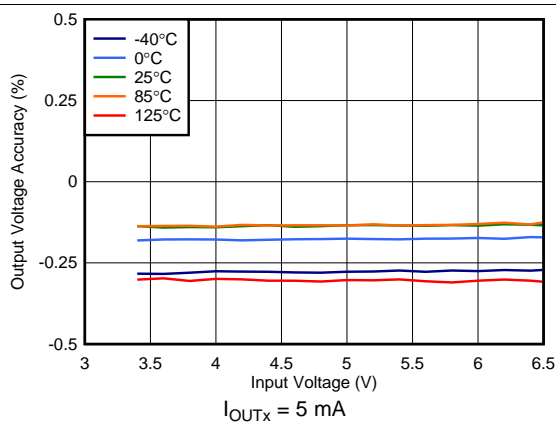

Figure 29. Line Regulation ( $V_{\text{OUTx}} = 3.3\text{ V}$ )

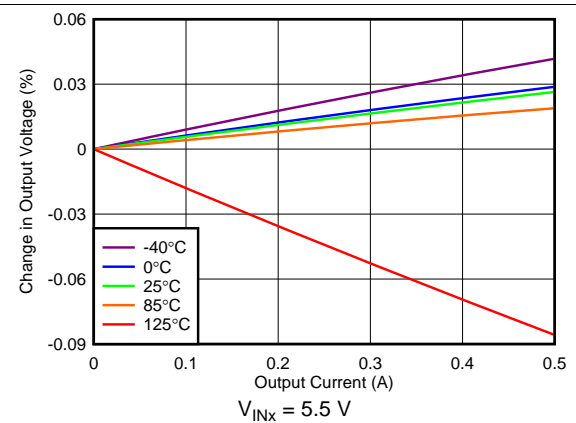

Figure 30. Load Regulation ( $V_{\text{OUTx}} = 5.0\text{ V}$ )

Typical Characteristics (continued)

at  $T_J = 25^\circ\text{C}$ ,  $1.4\text{ V} \leq V_{\text{INX}} < 6.5\text{ V}$ ,  $V_{\text{INX}} \geq V_{\text{OUTX(TARGET)}} + 0.3\text{ V}$ ,  $V_{\text{OUTX}} = 0.8\text{ V}$ ,  $\text{SS\_CTRLX} = \text{GND}$ ,  $I_{\text{OUTX}} = 5\text{ mA}$ ,  $V_{\text{ENX}} = 1.1\text{ V}$ ,  $C_{\text{OUTX}} = 10\text{ }\mu\text{F}$ ,  $C_{\text{NR/SSX}} = 0\text{ nF}$ ,  $C_{\text{FFX}} = 0\text{ nF}$ , PGx pin pulled up to  $V_{\text{OUTX}}$  with  $100\text{ k}\Omega$ , and  $\text{SS\_CTRLX} = \text{GND}$  (unless otherwise noted)

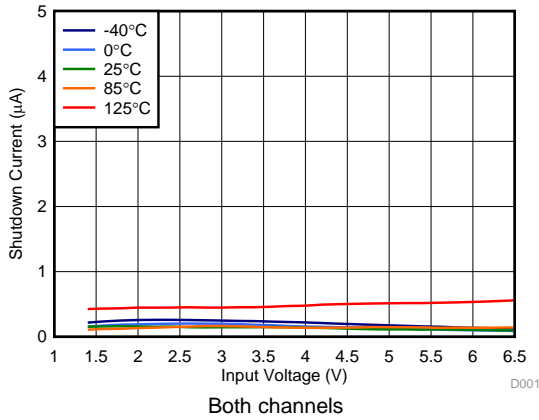

Figure 31. Shutdown Current vs Input Voltage

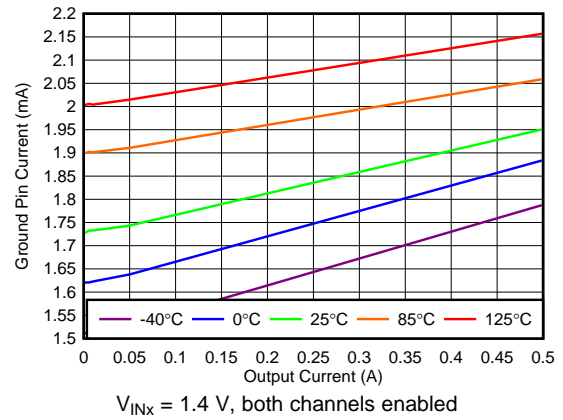

Figure 32. Ground Current vs Output Current

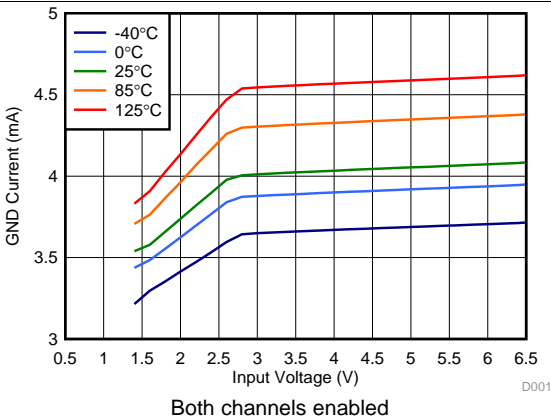

Figure 33. Ground Current vs Input Voltage

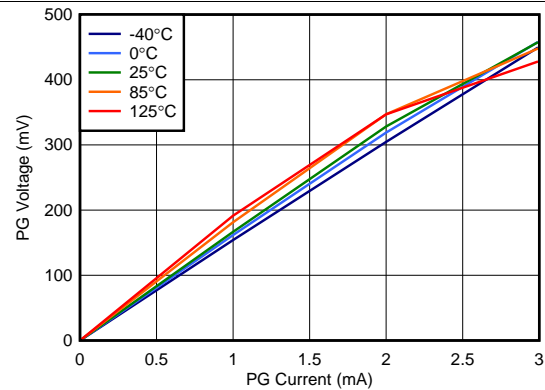

Figure 34. PGx Low Level vs PGx Current ( $V_{\text{INX}} = 1.4\text{ V}$ )

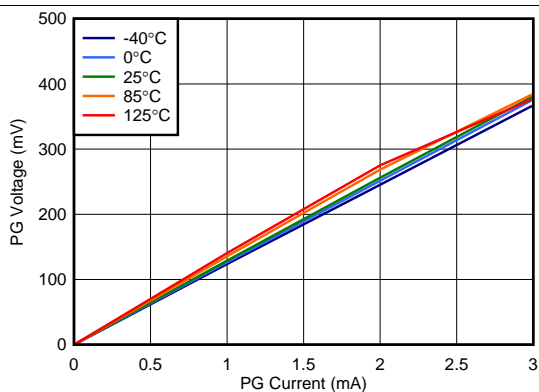

Figure 35. PGx Low Level vs PGx Current ( $V_{\text{INX}} = 6.5\text{ V}$ )

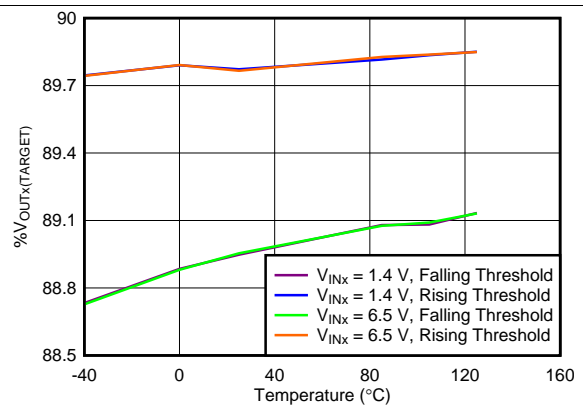

Figure 36. PGx Threshold vs Temperature

Typical Characteristics (continued)

at  $T_J = 25^\circ\text{C}$ ,  $1.4\text{ V} \leq V_{INX} < 6.5\text{ V}$ ,  $V_{INX} \geq V_{OUTX(TARGET)} + 0.3\text{ V}$ ,  $V_{OUTX} = 0.8\text{ V}$ ,  $SS\_CTRLX = \text{GND}$ ,  $I_{OUTX} = 5\text{ mA}$ ,  $V_{ENX} = 1.1\text{ V}$ ,  $C_{OUTX} = 10\ \mu\text{F}$ ,  $C_{NR/SSX} = 0\text{ nF}$ ,  $C_{FFX} = 0\text{ nF}$ , PGx pin pulled up to  $V_{OUTX}$  with  $100\text{ k}\Omega$ , and  $SS\_CTRLX = \text{GND}$  (unless otherwise noted)

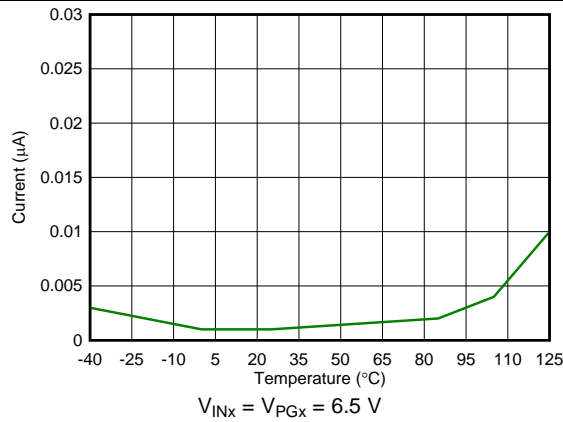

Figure 37. PGx Leakage Current vs Temperature

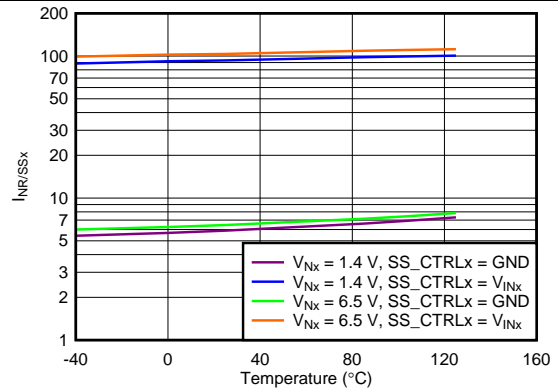

Figure 38. Soft-Start Current vs Temperature (SS\_CTRLx = GND)

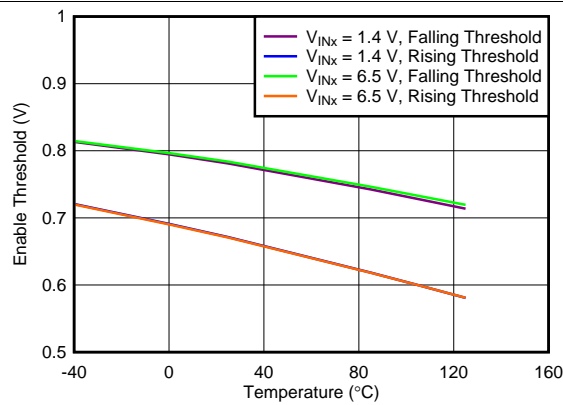

Figure 39. Enable Threshold vs Temperature

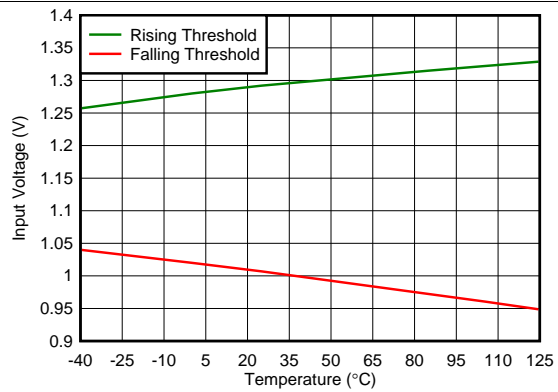

Figure 40. Input UVLOx Threshold vs Temperature



## 7.3 Feature Description

### 7.3.1 Voltage Regulation Features

#### 7.3.1.1 DC Regulation

An LDO functions as a class-B amplifier in which the input signal is the internal reference voltage ( $V_{REF}$ ), as shown in [Figure 41](#).  $V_{REF}$  is designed to have a very low-bandwidth at the input to the error amplifier through the use of a low-pass filter ( $V_{NR/SSx}$ ).

As such, the reference can be considered as a pure dc input signal. The low output impedance of an LDO comes from the combination of the output capacitor and pass element. The pass element also presents a high input impedance to the source voltage when operating as a current source. A positive LDO can only source current because of the class-B architecture.

This device achieves a maximum of 1% output voltage accuracy primarily because of the high-precision band-gap voltage ( $V_{BG}$ ) that creates  $V_{REF}$ . The low dropout voltage ( $V_{DO}$ ) reduces the thermal power dissipation required by the device to regulate the output voltage at a given current level, thereby improving system efficiency. Combined, these features help make this device a good approximation of an ideal voltage source.

This device replaces two stand-alone power-supplies, and also provides load-to-load isolation. The LDOs can also be put in series (cascaded) to achieve even higher PSRR by connecting the output of one channel to the input of the other channel.

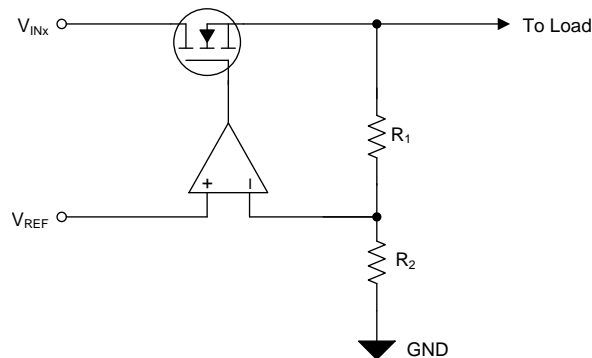

NOTE:  $V_{OUTx} = V_{REF} \times (1 + R_{1x} / R_{2x})$ .

**Figure 41. Simplified Regulation Circuit**

#### 7.3.1.2 AC and Transient Response

Each LDO responds quickly to a transient (large-signal response) on the input supply (line transient) or the output current (load transient) resulting from the LDO high-input impedance and low output-impedance across frequency. This same capability also means that each LDO has a high power-supply rejection-ratio (PSRR) and, when coupled with a low internal noise-floor ( $V_n$ ), the LDO approximates an ideal power supply in ac (small-signal) and large-signal conditions.

The performance and internal layout of the device minimizes the coupling of noise from one channel to the other channel (crosstalk). Good printed circuit board (PCB) layout minimizes the crosstalk.

The choice of external component values optimizes the small- and large-signal response. The NR/SSx capacitor ( $C_{NR/SSx}$ ) and feed-forward capacitor ( $C_{FFx}$ ) easily reduce the device noise floor and improve PSRR; see the [Optimizing Noise and PSRR](#) section for more information on optimizing the noise and PSRR performance.

### 7.3.2 System Start-Up Features

In many different applications, the power-supply output must turn-on within a specific window of time to either ensure proper operation of the load or to minimize the loading on the input supply or other sequencing requirements. Each LDO start-up is well-controlled and user-adjustable, solving the demanding requirements faced by many power-supply design engineers in a simple fashion.

## Feature Description (continued)

### 7.3.2.1 Programmable Soft-Start (NR/SSx)

Soft-start directly controls the output start-up time and indirectly controls the output current during start-up (in-rush current).

The external capacitor at the NR/SSx pin ( $C_{NR/SSx}$ ) sets the output start-up time by setting the rise time of the internal reference ( $V_{NR/SSx}$ ), as shown in Figure 42. SS\_CTRLx provides additional control over the rise time of the internal reference ( $V_{NR/SSx}$ ) by enabling control over the charging current ( $I_{NR/SSx}$ ) for  $C_{NR/SSx}$ . The voltage at the SS\_CTRLx pin ( $V_{SS\_CTRLx}$ ) must be connected to ground (GND) or  $V_{INx}$ .

Note that if  $C_{NR/SSx} = 0$  nF and the SS\_CTRLx pin is connected to  $V_{INx}$ , then the output voltage overshoots during start-up.

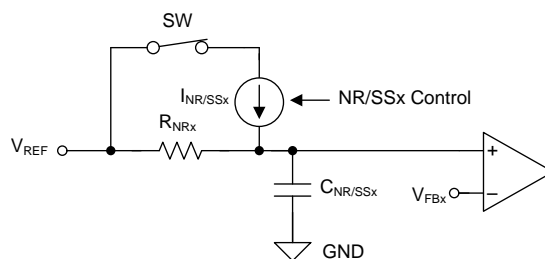

Figure 42. Simplified Soft-Start Circuit

### 7.3.2.2 Sequencing

Controlling when a single power supply turns on can be difficult in a power distribution network (PDN) because of the high power levels inherent in a PDN, and the variations between all of the supplies. Control of each channel turn-on and turn-off time is set by the specific channel enable circuit (ENx) and undervoltage lockout circuit (UVLOx), as shown in Figure 43 and Table 2.

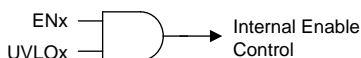

Figure 43. Simplified Turn-On Control

Table 2. Sequencing Functionality Table

INPUT VOLTAGE	ENABLE STATUS	LDO STATUS	ACTIVE DISCHARGE	POWER-GOOD
$V_{INx} \geq V_{UVLOx}$	ENx = 1	On	Off	PGx = 1 when $V_{OUTx} \geq V_{IT(PGx)}$
	ENx = 0	Off	On	PGx = 0
$V_{INx} < V_{UVLOx} - V_{HYS}$	ENx = don't care	Off	On <sup>(1)</sup>	PGx = 0

(1) The active discharge remains on as long as  $V_{INx}$  provides enough headroom for the discharge circuit to function.

#### 7.3.2.2.1 Enable (ENx)

The enable signal ( $V_{ENx}$ ) is an active-high digital control that enables the LDO when the enable voltage is past the rising threshold ( $V_{ENx} \geq V_{IH(ENx)}$ ) and disables the LDO when the enable voltage is below the falling threshold ( $V_{ENx} \leq V_{IL(ENx)}$ ). The exact enable threshold is between  $V_{IH(ENx)}$  and  $V_{IL(ENx)}$  because ENx is a digital control. In applications that do not use the enable control, connect ENx to  $V_{INx}$ .

### 7.3.2.2 Undervoltage Lockout (UVLOx) Control

The UVLOx circuit responds quickly to glitches on  $V_{INx}$  and attempts to disable the output of the device if either of these rails collapse.

As a result of the fast response time of the input supply UVLOx circuit, fast and short line transients well below the input supply UVLOx falling threshold (brownouts) can cause momentary glitches during the edges of the transient. These glitches are typical in most LDOs and, in most applications, the brownouts required for these glitches do not result from the local input capacitance; see the [Undervoltage Lockout \(UVLOx\) Control](#) section for more details.

### 7.3.2.3 Active Discharge

When either ENx or UVLOx is low, the device connects a resistor of several hundred ohms from  $V_{OUTx}$  to GND, discharging the output capacitance.

Do not rely on the active discharge circuit for discharging large output capacitors when the input voltage drops below the targeted output voltage. Current flows from the output to the input (reverse current) when  $V_{OUTx} > V_{INx}$ , which can cause damage to the device (when  $V_{OUTx} > V_{INx} + 0.3\text{ V}$ ); see the [Reverse Current Protection](#) section for more details.

### 7.3.2.3 Power-Good Output (PGx)

The PGx signal provides an easy solution to meet demanding sequencing requirements because PGx signals when the output nears its nominal value. PGx can be used to signal other devices in a system when the output voltage is near, at, or above the set output voltage ( $V_{OUTx(\text{Target})}$ ). A simplified schematic is shown in [Figure 44](#).

The PGx signal is an open-drain digital output that requires a pullup resistor to a voltage source and is active high. The power-good circuit sets the PGx pin into a high-impedance state to indicate that the power is good.

Using a large feed-forward capacitor ( $C_{FFx}$ ) delays the output voltage and, because the power-good circuit monitors the FBx pin, the PGx signal can indicate a false positive. A simple solution to this scenario is to use an external voltage detector device, such as the [TPS3780](#); see the [Feed-Forward Capacitor \( \$C\_{FFx}\$ \)](#) section for more information.

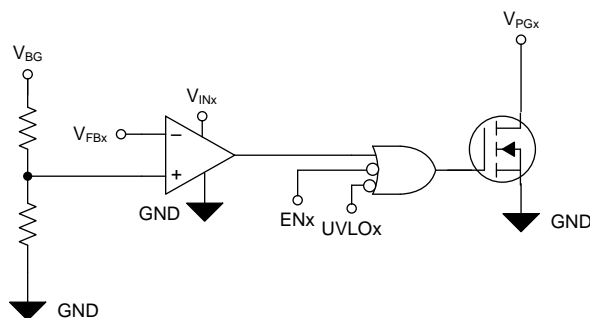

**Figure 44. Simplified PGx Circuit**



### 7.3.3 Internal Protection Features

In many applications, fault events can occur that damage devices in the system. Short-circuits and excessive heat are the most common fault events for power supplies. The TPS7A87 implements circuitry for each LDO to protect the device and its load during these events. Continuously operating in these fault conditions or above a junction temperature of 125°C is not recommended because the long-term reliability of the device is reduced.

#### 7.3.3.1 Foldback Current Limit ( $I_{CLx}$ )

The internal current limit circuit protects the LDO against short-circuit and excessive load current conditions. The output current decreases (folds back) when the output voltage falls to better protect the device, as described in [Figure 19](#). Each channel features its own independent current limit circuit.

#### 7.3.3.2 Thermal Protection ( $T_{sdx}$ )

The thermal shutdown circuit protects the LDO against excessive heat in the system, either resulting from current limit or high ambient temperature. Each channel features its own independent thermal shutdown circuit.

The output of the LDO turns off when the LDO temperature (junction temperature,  $T_J$ ) exceeds the rising thermal shutdown temperature ( $T_{sdx}$ ). The output turns on again after  $T_J$  decreases below the falling thermal shutdown temperature ( $T_{sdx}$ ).

A high power dissipation across the device, combined with a high ambient temperature ( $T_A$ ), can cause  $T_J$  to be greater than or equal to  $T_{sdx}$ , triggering the thermal shutdown and causing the output to fall to 0 V. The LDO can cycle on and off when thermal shutdown is reached under these conditions.

## 7.4 Device Functional Modes

[Table 3](#) provides a quick comparison between the regulation and disabled operation.

**Table 3. Device Functional Modes Comparison**

OPERATING MODE	PARAMETER			
	$V_{INx}$	$ENx$	$I_{OUTx}$	$T_J$
Regulation <sup>(1)</sup>	$V_{INx} > V_{OUTx(nom)} + V_{DO}$	$V_{ENx} > V_{IH(ENx)}$	$I_{OUTx} < I_{CLx}$	$T_J < T_{sd}$
Disabled <sup>(2)</sup>	$V_{INx} < V_{UVLOx}$	$V_{ENx} < V_{IL(ENx)}$	—	$T_J > T_{sd}$

(1) All table conditions must be met.

(2) The device is disabled when any condition is met.

#### 7.4.1 Regulation

The device regulates the output to the targeted output voltage when all the conditions in [Table 3](#) are met.

#### 7.4.2 Disabled

When disabled, the pass device is turned off, the internal circuits are shutdown, and the output voltage is actively discharged to ground by an internal resistor from the output to ground.

## 8 Application and Implementation

### NOTE

Information in the following applications sections is not part of the TI component specification, and TI does not warrant its accuracy or completeness. TI's customers are responsible for determining suitability of components for their purposes. Customers should validate and test their design implementation to confirm system functionality.

### 8.1 Application Information

Successfully implementing an LDO in an application depends on the application requirements. This section discusses key device features and how to best implement them to achieve a reliable design.

#### 8.1.1 External Component Selection

##### 8.1.1.1 Setting the Output Voltage (Adjustable Operation)

Each LDO resistor feedback network sets the output voltage, as shown in [Figure 45](#), with an output voltage range of 0.8 V to 5.2 V.

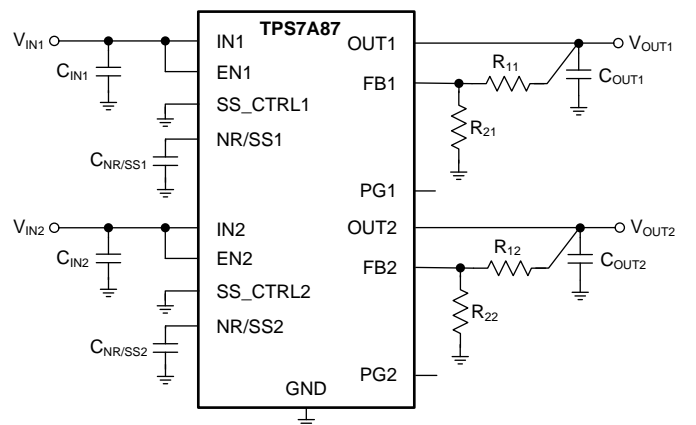

Copyright © 2016, Texas Instruments Incorporated

**Figure 45. Adjustable Operation**

[Equation 1](#) relates the values  $R_{1x}$  and  $R_{2x}$  to  $V_{OUTx(Target)}$  and  $V_{FBx}$ . [Equation 1](#) is a rearranged version of [Equation 2](#), simplifying the feedback resistor calculation. The current through the feedback network must be equal to or greater than 5  $\mu$ A for optimum noise performance and accuracy, as shown in [Equation 3](#).

$$V_{OUTx} = V_{FBx} \times (1 + R_{1x} / R_{2x}) \quad (1)$$

$$R_{1x} = (V_{OUTx} / V_{FBx} - 1) \times R_{2x} \quad (2)$$

$$R_{2x} < V_{REF} / 5 \mu A \quad (3)$$

The input bias current into the error amplifier (feedback pin current,  $I_{FBx}$ ) and tighter tolerance resistors must be taken into account for optimizing the output voltage accuracy.

## Application Information (continued)

Table 4 shows the resistor combinations for several common output voltages using commercially-available, 1% tolerance resistors.

**Table 4. Recommended Feedback-Resistor Values**

TARGETED OUTPUT VOLTAGE (V)	FEEDBACK RESISTOR VALUES <sup>(1)</sup>		CALCULATED OUTPUT VOLTAGE (V)
	R <sub>1x</sub> (kΩ)	R <sub>2x</sub> (kΩ)	
0.80	Short	Open	0.800
0.90	1.37	11.0	0.900
0.95	1.91	10.2	0.950
1.00	2.55	10.2	1.000
1.05	3.32	10.7	1.048
1.10	3.57	9.53	1.100
1.15	4.64	10.7	1.147
1.20	5.49	11.0	1.199
1.35	6.98	10.2	1.347
1.50	9.31	10.7	1.496
1.80	13.70	11.0	1.796
1.90	14.70	10.7	1.899
2.50	22.60	10.7	2.490
2.85	27.40	10.7	2.849
3.00	29.40	10.7	2.998
3.30	33.20	10.7	3.282
3.60	35.70	10.2	3.600
4.50	44.20	9.53	4.510
5.00	56.20	10.7	5.002
5.20	53.60	9.76	5.193

(1) R<sub>1x</sub> is connected from OUT<sub>x</sub> to FB<sub>x</sub>; R<sub>2x</sub> is connected from FB<sub>x</sub> to GND; see Figure 45.

### 8.1.1.2 Capacitor Recommendations

The device is designed to be stable using low equivalent series resistance (ESR) ceramic capacitors at the input and output pins. Multilayer ceramic capacitors have become the industry standard for these types of applications and are recommended, but must be used with good judgment. Ceramic capacitors that employ X7R-, X5R-, and COG-rated dielectric materials provide relatively good capacitive stability across temperature, whereas the use of Y5V-rated capacitors is discouraged because of large variations in capacitance.

Regardless of the ceramic capacitor type selected, ceramic capacitance varies with operating voltage and temperature. As a rule of thumb, derate ceramic capacitors by at least 50%. The input and output capacitors recommended herein account for an effective capacitance derating of approximately 50%, but at higher V<sub>INx</sub> and V<sub>OUTx</sub> conditions (that is, V<sub>INx</sub> = 5.5 V to V<sub>OUTx</sub> = 5.0 V) the derating can be greater than 50% and must be taken into consideration.

### 8.1.1.3 Input and Output Capacitor (C<sub>INx</sub> and C<sub>OUTx</sub>)

The device is designed and characterized for operation with ceramic capacitors of 10 μF or greater (5 μF or greater of effective capacitance) at each input and output. Locate the input and output capacitors as near as practical to the respective input and output pins to minimize the trace inductance from the capacitor to the device.

### 8.1.1.4 Feed-Forward Capacitor ( $C_{FFx}$ )

Although a feed-forward capacitor ( $C_{FFx}$ ) from the FBx pin to the OUTx pin is not required to achieve stability, a 10-nF external  $C_{FFx}$  optimizes the transient, noise, and PSRR performance. A higher capacitance  $C_{FFx}$  can be used; however, the start-up time is longer and the power-good signal can incorrectly indicate that the output voltage is settled. The maximum recommended value is 100 nF.

To ensure proper PGx functionality, the time constant defined by  $C_{NR/SSx}$  must be greater than or equal to the time constant from  $C_{FFx}$ . For a detailed description, see the [Pros and Cons of Using a Feed-Forward Capacitor with a Low Dropout Regulator application report](#) (SBVA042).

### 8.1.1.5 Noise-Reduction and Soft-Start Capacitor ( $C_{NR/SSx}$ )

Although a noise-reduction and soft-start capacitor ( $C_{NR/SSx}$ ) from the NR/SSx pin to GND is not required,  $C_{NR/SSx}$  is highly recommended to control the start-up time and reduce the noise-floor of the device. The typical value used is 10 nF, and the maximum recommended value is 10  $\mu$ F.

## 8.1.2 Start-Up

### 8.1.2.1 Circuit Soft-Start Control (NR/SSx)

Each output of the device features a user-adjustable, monotonic, voltage-controlled soft-start that is set with an external capacitor ( $C_{NR/SSx}$ ). This soft-start eliminates power-up initialization problems when powering field-programmable gate arrays (FPGAs), digital signal processors (DSPs), or other processors. The controlled voltage ramp of the output also reduces peak inrush current during start-up, thus minimizing start-up transients to the input power bus.

The output voltage ( $V_{OUTx}$ ) rises proportionally to  $V_{NR/SSx}$  during start-up as the LDO regulates so that the feedback voltage equals the NR/SSx voltage ( $V_{FBx} = V_{NR/SSx}$ ). As such, the time required for  $V_{NR/SSx}$  to reach its nominal value determines the rise time of  $V_{OUTx}$  (start-up time).

The soft-start ramp time depends on the soft-start charging current ( $I_{NR/SSx}$ ), the soft-start capacitance ( $C_{NR/SSx}$ ), and the internal reference ( $V_{REF}$ ). The approximate soft-start ramp time ( $t_{SSx}$ ) can be calculated with [Equation 4](#):

$$t_{SSx} = (V_{REF} \times C_{NR/SSx}) / I_{NR/SSx} \quad (4)$$

The SS\_CTRLx pin for each output sets the value of the internal current source, maintaining a fast start-up time even with a large  $C_{NR/SSx}$  capacitor. When the SS\_CTRLx pin is connected to GND, the typical value for the  $I_{NR/SSx}$  current is 6.2  $\mu$ A. Connecting the SS\_CTRLx pin to INx increases the typical soft-start charging current to 100  $\mu$ A. The larger charging current for  $I_{NR/SSx}$  is useful when smaller start-up ramp times are needed or when using larger noise-reduction capacitors.

Not using a noise-reduction capacitor on the NR/SSx pin and tying the SS\_CTRLx pin to  $V_{INx}$  results in output voltage overshoot of approximately 10%. Connecting the SS\_CTRLx pin to GND or using a capacitor on the NR/SSx pin minimizes the overshoot.

Values for the soft-start charging currents are provided in the [Electrical Characteristics](#) table.

#### 8.1.2.1.1 In-Rush Current

In-rush current is defined as the current into the LDO at the INx pin during start-up. In-rush current then consists primarily of the sum of load current and the current used to charge the output capacitor. This current is difficult to measure because the input capacitor must be removed, which is not recommended. However, this soft-start current can be estimated by [Equation 5](#):

$$I_{OUTx(t)} = \left[ \frac{C_{OUTx} \times dV_{OUTx}(t)}{dt} \right] + \left[ \frac{V_{OUTx}(t)}{R_{LOAD}} \right]$$

where:

- $V_{OUTx}(t)$  is the instantaneous output voltage of the turn-on ramp
- $dV_{OUTx}(t) / dt$  is the slope of the  $V_{OUTx}$  ramp
- $R_{LOAD}$  is the resistive load impedance

(5)

### 8.1.2.2 Undervoltage Lockout (UVLOx) Control

The UVLOx circuit ensures that the device stays disabled before its input or bias supplies reach the minimum operational voltage range, and ensures that the device properly shuts down when the input supply collapses.

Figure 46 and Table 5 explain the UVLOx circuit response to various input voltage events, assuming  $V_{ENx} \geq V_{IH(ENx)}$ .

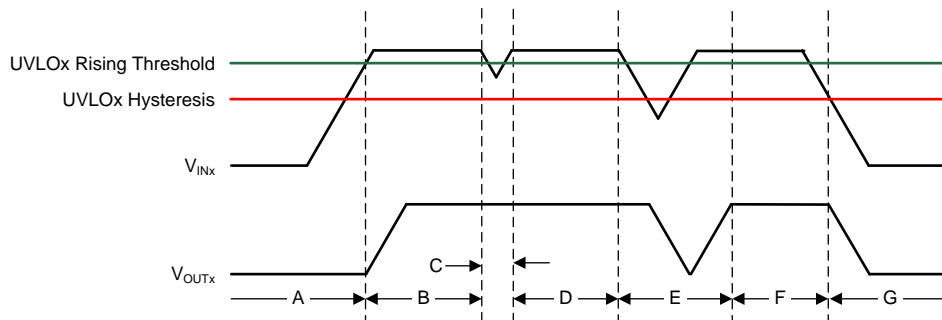

Figure 46. Typical UVLOx Operation

Table 5. Typical UVLOx Operation Description

REGION	EVENT	$V_{OUTx}$ STATUS	COMMENT
A	Turn-on, $V_{INx} \geq V_{UVLOx}$	0	Start-up
B	Regulation	1	Regulates to target $V_{OUTx}$
C	Brownout, $V_{INx} \geq V_{UVLOx} - V_{HYS}$	1	The output can fall out of regulation but the device is still enabled.
D	Regulation	1	Regulates to target $V_{OUTx}$
E	Brownout, $V_{INx} < V_{UVLOx} - V_{HYS}$	0	The device is disabled and the output falls because of the load and active discharge circuit. The device is reenabled when the UVLOx rising threshold is reached by the input voltage and a normal start-up then follows.
F	Regulation	1	Regulates to target $V_{OUTx}$
G	Turn-off, $V_{INx} < V_{UVLOx} - V_{HYS}$	0	The output falls because of the load and active discharge circuit.

Similar to many other LDOs with this feature, the UVLOx circuit takes a few microseconds to fully assert. During this time, a downward line transient below approximately 0.8 V causes the UVLOx to assert for a short time; however, the UVLOx circuit does not have enough stored energy to fully discharge the internal circuits inside of the device. When the UVLOx circuit is not given enough time to fully discharge the internal nodes, the outputs are not fully disabled.

The effect of the downward line transient can be mitigated by using a larger input capacitor to increase the fall time of the input supply when operating near the minimum  $V_{INx}$ .

### 8.1.2.3 Power-Good (PGx) Function

The power-good circuit monitors the voltage at the feedback pin to indicate the status of the output voltage. The power-good circuit asserts whenever FBx, V<sub>INx</sub>, or ENx are below their thresholds. The PGx operation versus the output voltage is shown in Figure 47, which is described by Table 6.

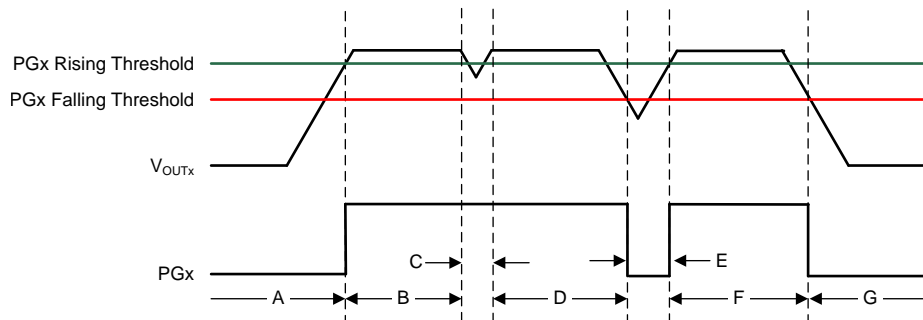

**Figure 47. Typical PGx Operation**

**Table 6. Typical PGx Operation Description**

REGION	EVENT	PGx STATUS	FBx VOLTAGE
A	Turn-on	0	$V_{FBx} < V_{IT(PGx)} + V_{HYS(PGx)}$
B	Regulation	Hi-Z	$V_{FBx} \geq V_{IT(PGx)}$
C	Output voltage dip	Hi-Z	
D	Regulation	Hi-Z	
E	Output voltage dip	0	$V_{FBx} < V_{IT(PGx)}$
F	Regulation	Hi-Z	$V_{FBx} \geq V_{IT(PGx)}$
G	Turn-off	0	$V_{FBx} < V_{IT(PGx)}$

The PGx pin is open-drain and connecting a pullup resistor to an external supply enables other devices to receive power-good as a logic signal that can be used for sequencing. Make sure that the external pullup supply voltage results in a valid logic signal for the receiving device or devices.

To ensure proper operation of the power-good circuit, the pullup resistor value must be between 10 kΩ and 100 kΩ. The lower limit of 10 kΩ results from the maximum pulldown strength of the power-good transistor, and the upper limit of 100 kΩ results from the maximum leakage current at the power-good node. If the pullup resistor is outside of this range, then the power-good signal may not read a valid digital logic level.

Using a large C<sub>FFx</sub> with a small C<sub>NR/SSx</sub> causes the power-good signal to incorrectly indicate that the output voltage has settled during turn-on. The C<sub>FFx</sub> time constant must be greater than the soft-start time constant to ensure proper operation of the PGx during start-up. For a detailed description, see the [Pros and Cons of Using a Feed-Forward Capacitor with a Low Dropout Regulator application report](#) (SBVA042).

The state of PGx is only valid when the device operates above the minimum supply voltage. During short brownout events and at light loads, power-good does not assert because the output voltage (therefore V<sub>FBx</sub>) is sustained by the output capacitance.

### 8.1.3 AC and Transient Performance

LDO ac performance for a dual-channel device includes power-supply rejection ratio, channel-to-channel output isolation, output current transient response, and output noise. These metrics are primarily a function of open-loop gain, bandwidth, and phase margin that control the closed-loop input and output impedance of the LDO. The output noise is primarily a result of the reference and error amplifier noise.

### 8.1.3.1 Power-Supply Rejection Ratio (PSRR)

PSRR is a measure of how well the LDO control-loop rejects signals from  $V_{INx}$  to  $V_{OUTx}$  across the frequency spectrum (usually 10 Hz to 10 MHz). Equation 6 gives the PSRR calculation as a function of frequency for the input signal  $[V_{INx}(f)]$  and output signal  $[V_{OUTx}(f)]$ .

$$PSRR \text{ (dB)} = 20 \text{ Log}_{10} \left( \frac{V_{INx}(f)}{V_{OUTx}(f)} \right) \tag{6}$$

Even though PSRR is a loss in signal amplitude, PSRR is shown as positive values in decibels (dB) for convenience.

A simplified diagram of PSRR versus frequency is shown in Figure 48.

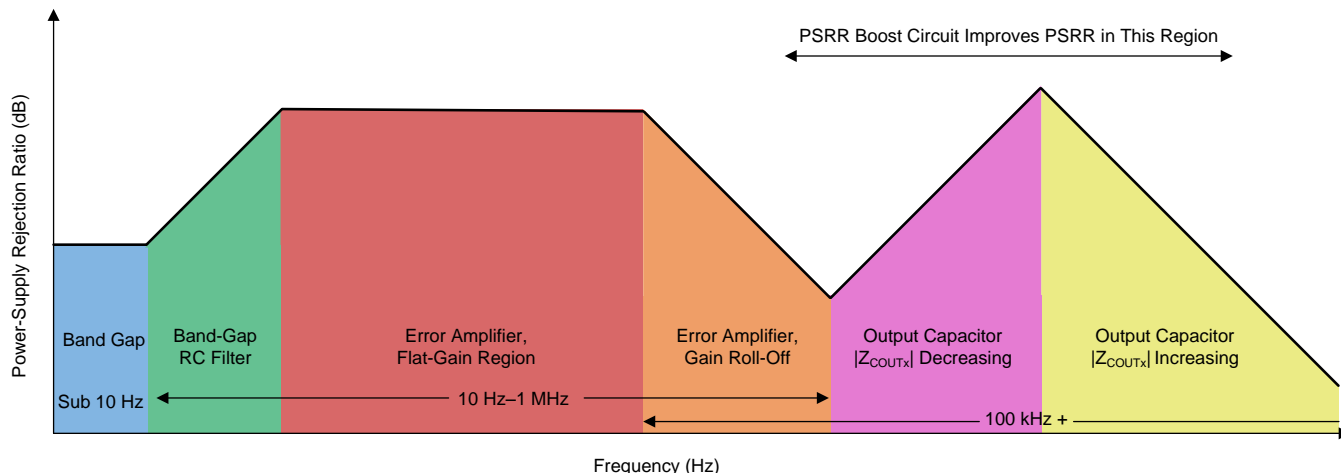

Figure 48. Power-Supply Rejection Ratio Diagram

An LDO is often employed not only as a dc-dc regulator, but also to provide exceptionally clean power-supply voltages that exhibit ultra-low noise and ripple to sensitive system components. This usage is especially true for the TPS7A87.

The TPS7A87 features an innovative circuit to boost the PSRR between 200 kHz and 1 MHz; see Figure 4. To achieve the maximum benefit of this PSRR boost circuit, using a capacitor with a minimum impedance in the 100-kHz to 1-MHz band is recommended.

### 8.1.3.2 Channel-to-Channel Output Isolation and Crosstalk

Output isolation is a measure of how well the device prevents voltage disturbances on one output from affecting the other output. This attenuation appears in load transient tests on the other output; however, to numerically quantify the rejection, the output channel isolation is expressed in decibels (dB).

Output isolation performance is a strong function of the PCB layout. See the [Layout](#) section on how to best optimize the isolation performance.

### 8.1.3.3 Output Voltage Noise

The TPS7A87 is designed for system applications where minimizing noise on the power-supply rail is critical to system performance. For example, the TPS7A87 can be used in a phase-locked loop (PLL)-based clocking circuit can be used for minimum phase noise, or in test and measurement systems where even small power-supply noise fluctuations reduce system dynamic range.

LDO noise is defined as the internally-generated intrinsic noise created by the semiconductor circuits alone. This noise is the sum of various types of noise (such as shot noise associated with current-through-pin junctions, thermal noise caused by thermal agitation of charge carriers, flicker noise, or 1/f noise and dominates at lower frequencies as a function of 1/f). Figure 49 shows a simplified output voltage noise density plot versus frequency.

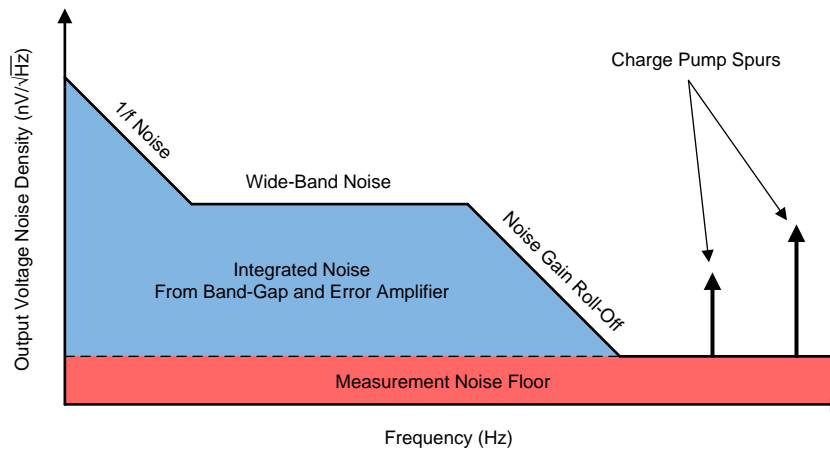

Figure 49. Output Voltage Noise Diagram

For further details, see the [How to Measure LDO Noise white paper](#) (SLYY076).

### 8.1.3.4 Optimizing Noise and PSRR

The ultra-low noise floor and PSRR of the device can be improved in several ways, as described in Table 7.

Table 7. Effect of Various Parameters on AC Performance<sup>(1)(2)</sup>

PARAMETER	NOISE			PSRR		
	LOW-FREQUENCY	MID-FREQUENCY	HIGH-FREQUENCY	LOW-FREQUENCY	MID-FREQUENCY	HIGH-FREQUENCY
C <sub>NR/SSx</sub>	+++	No effect	No effect	+++	+	No effect
C <sub>FFx</sub>	++	+++	+	++	+++	+
C <sub>OUTx</sub>	No effect	+	+++	No effect	+	+++
V <sub>INx</sub> – V <sub>OUTx</sub>	+	+	+	+++	+++	++
PCB layout	++	++	+	+	+++	+++

(1) The number of +'s indicates the improvement in noise or PSRR performance by increasing the parameter value.

(2) Shaded cells indicate the easiest improvement to noise or PSRR performance.

The noise-reduction capacitor, in conjunction with the noise-reduction resistor, forms a low-pass filter (LPF) that filters out the noise from the reference before being gained up with the error amplifier, thereby minimizing the output voltage noise floor. The LPF is a single-pole filter and the cutoff frequency can be calculated with Equation 7. The typical value of R<sub>NR</sub> is 250 kΩ. The effect of the C<sub>NR/SSx</sub> capacitor increases when V<sub>OUTx(Target)</sub> increases because the noise from the reference is gained up when the output voltage increases. For low-noise applications, a 10-nF to 10-μF C<sub>NR/SSx</sub> is recommended.

$$f_{\text{cutoff}} = 1 / (2 \times \pi \times R_{\text{NR}} \times C_{\text{NR/SSx}}) \tag{7}$$

The feed-forward capacitor reduces output voltage noise by filtering out the mid-band frequency noise. The feed-forward capacitor can be optimized by placing a pole-zero pair near the edge of the loop bandwidth and pushing out the loop bandwidth, thus improving mid-band PSRR.



A larger  $C_{OUTx}$  or multiple output capacitors reduces high-frequency output voltage noise and PSRR by reducing the high-frequency output impedance of the power supply.

Additionally, a higher input voltage improves the noise and PSRR because greater headroom is provided for the internal circuits. However, a high power dissipation across the die increases the output noise because of the increase in junction temperature.

Good PCB layout improves the PSRR and noise performance by providing heatsinking at low frequencies and isolating  $V_{OUTx}$  at high frequencies.

[Table 8](#) lists the output voltage noise for the 10-Hz to 100-kHz band at a 5-V output for a variety of conditions with an input voltage of 5.4 V, an  $R_{1x}$  of 12.1 k $\Omega$ , and a load current of 0.5 A. The 5-V output is chosen because this output is the worst-case condition for output voltage noise.

**Table 8. Output Noise Voltage at a 5-V Output with a 5.4-V Input**

$C_{NR/SSx}$ (nF)	$C_{FFx}$ (nF)	$C_{OUTx}$ ( $\mu$ F)	SS_CTRLx	OUTPUT VOLTAGE NOISE ( $\mu$ V <sub>RMS</sub> )
10	10	22	$V_{INx}$	10.8
1000	100	22	$V_{INx}$	5.6
1000	100	22	GND	5.6
1000	100	22    1000	$V_{INx}$	5.0

#### 8.1.3.4.1 Charge Pump Noise

The device internal charge pump generates a minimal amount of noise.

The high-frequency components of the output voltage noise density curve are filtered out in most applications by using 10-nF to 100-nF bypass capacitors close to the load. Using a ferrite bead between the LDO output and the load input capacitors forms a pi-filter, further reducing the high-frequency noise contribution.

### 8.1.3.5 Load Transient Response

The load-step transient response is the output voltage response by the LDO to a step in load current, whereby output voltage regulation is maintained. There are two key transitions during a load transient response: the transition from a light to a heavy load and the transition from a heavy to a light load. The regions shown in [Figure 50](#) are broken down in this section and are described in [Table 9](#). Regions A, E, and H are where the output voltage is in steady-state.

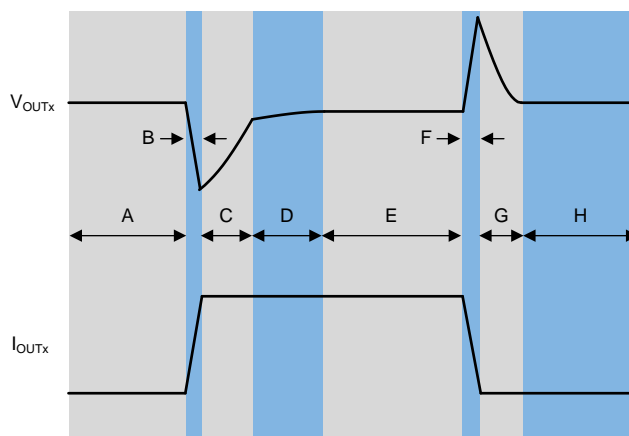
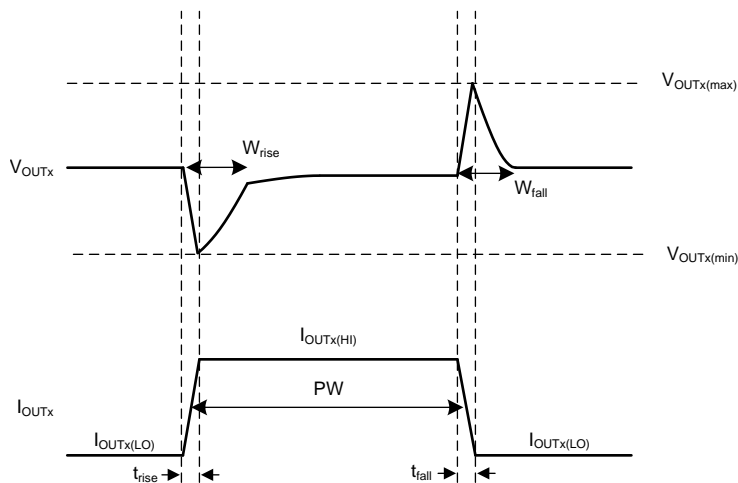

**Figure 50. Load Transient Waveform**

**Table 9. Load Transient Waveform Description**

REGION	DESCRIPTION	COMMENT
A	Regulation	Regulation
B	Output current ramping	Initial voltage dip is a result of the depletion of the output capacitor charge.
C	LDO responding to transient	Recovery from the dip results from the LDO increasing its sourcing current, and leads to output voltage regulation.
D	Reaching thermal equilibrium	At high load currents the LDO takes some time to heat up. During this time the output voltage changes slightly.
E	Regulation	Regulation
F	Output current ramping	Initial voltage rise results from the LDO sourcing a large current, and leads to the output capacitor charge to increase.
G	LDO responding to transient	Recovery from the rise results from the LDO decreasing its sourcing current in combination with the load discharging the output capacitor.
H	Regulation	Regulation

The transient response peaks ( $V_{OUTx(max)}$  and  $V_{OUTx(min)}$ ) are improved by using more output capacitance; however, doing so slows down the recovery time ( $W_{rise}$  and  $W_{fall}$ ). Figure 51 shows these parameters during a load transient, with a given pulse duration (PW) and current levels ( $I_{OUTx(LO)}$  and  $I_{OUTx(HI)}$ ).



**Figure 51. Simplified Load Transient Waveform**

### 8.1.4 DC Performance

#### 8.1.4.1 Output Voltage Accuracy ( $V_{OUTx}$ )

The device features an output voltage accuracy of 1% maximum that includes the errors introduced by the internal reference, load regulation, line regulation, and operating temperature as specified by the [Electrical Characteristics](#) table. Output voltage accuracy specifies minimum and maximum output voltage error, relative to the expected nominal output voltage stated as a percent.

#### 8.1.4.2 Dropout Voltage ( $V_{DO}$ )

Generally speaking, the dropout voltage often refers to the minimum voltage difference between the input and output voltage ( $V_{DO} = V_{INx} - V_{OUTx}$ ) that is required for regulation. When  $V_{INx}$  drops below the required  $V_{DO}$  for the given load current, the device functions as a resistive switch and does not regulate output voltage. Dropout voltage is proportional to the output current because the device is operating as a resistive switch, as shown in Figure 52.

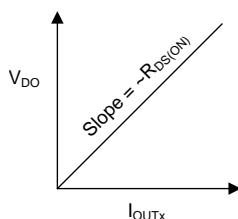

**Figure 52. Dropout Voltage versus Output Current**

Dropout voltage is affected by the drive strength for the gate of the pass element, which is nonlinear with respect to  $V_{INx}$  on this device because of the internal charge pump. Dropout voltage increases exponentially when the input voltage nears its maximum operating voltage because the charge pump multiplies the input voltage by a factor of 4 and then is internally clamped to 8.0 V.

#### 8.1.4.2.1 Behavior when Transitioning from Dropout into Regulation

Some applications can have transients that place the LDO into dropout, such as slower ramps on  $V_{INx}$  for start-up or load transients. As with many other LDOs, the output can overshoot on recovery from these conditions.

A ramping input supply can cause an LDO to overshoot on start-up when the slew rate and voltage levels are in the right range, as shown in [Figure 53](#). This condition is easily avoided through either the use of an enable signal, or by increasing the soft-start time with  $C_{SS}/NR_x$ .

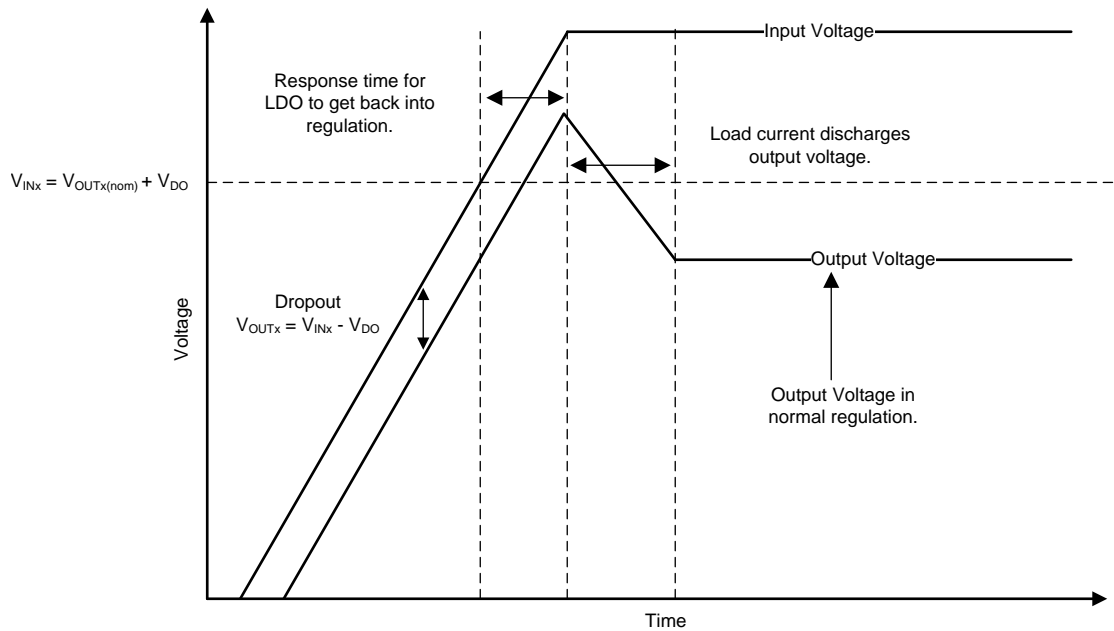

Figure 53. Start-Up Into Dropout

### 8.1.5 Reverse Current Protection

As with most LDOs, this device can be damaged by excessive reverse current.

Reverse current is current that flows through the body diode on the pass element instead of the normal conducting channel. This current flow, at high enough magnitudes, degrades long-term reliability of the device resulting from risks of electromigration and excess heat being dissipated across the device. If the current flow gets high enough, a latch-up condition can be entered.

Conditions where excessive reverse current can occur are outlined in this section, all of which can exceed the absolute maximum rating of  $V_{OUTx} > V_{INx} + 0.3\text{ V}$ :

- If the device has a large  $C_{OUTx}$  and the input supply collapses quickly with little or no load current
- The output is biased when the input supply is not established
- The output is biased above the input supply

If excessive reverse current flow is expected in the application, then external protection must be used to protect the device. [Figure 54](#) shows one approach of protecting the device.

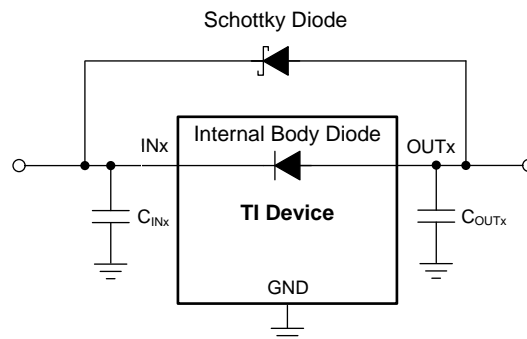

Copyright © 2016, Texas Instruments Incorporated

Figure 54. Example Circuit for Reverse Current Protection Using a Schottky Diode

### 8.1.6 Power Dissipation ( $P_D$ )

Circuit reliability demands that proper consideration is given to device power dissipation, location of the circuit on the printed circuit board (PCB), and correct sizing of the thermal plane. The PCB area around the regulator must be as free as possible of other heat-generating devices that cause added thermal stresses.

As a first-order approximation, power dissipation in the regulator depends on the input-to-output voltage difference and load conditions.  $P_D$  can be approximated using [Equation 8](#):

$$P_D = (V_{OUTx} - V_{INx}) \times I_{OUTx} \quad (8)$$

An important note is that power dissipation can be minimized, and thus greater efficiency achieved, by proper selection of the system voltage rails. Proper selection allows the minimum input-to-output voltage differential to be obtained. The low dropout of the device allows for maximum efficiency across a wide range of output voltages.

The main heat conduction path for the device is through the thermal pad on the package. As such, the thermal pad must be soldered to a copper pad area under the device. This pad area contains an array of plated vias that conduct heat to any inner plane areas or to a bottom-side copper plane.

The maximum power dissipation determines the maximum allowable junction temperature ( $T_J$ ) for the device. Power dissipation and junction temperature are most often related by the junction-to-ambient thermal resistance ( $\theta_{JA}$ ) of the combined PCB, device package, and the temperature of the ambient air ( $T_A$ ), according to [Equation 9](#). The equation is rearranged for output current in [Equation 10](#).

$$T_J = T_A + \theta_{JA} \times P_D \quad (9)$$

$$I_{OUTx} = (T_J - T_A) / [\theta_{JA} \times (V_{INx} - V_{OUTx})] \quad (10)$$

Unfortunately, this thermal resistance ( $\theta_{JA}$ ) is highly dependent on the heat-spreading capability built into the particular PCB design, and therefore varies according to the total copper area, copper weight, and location of the planes. The  $\theta_{JA}$  recorded in the table is determined by the JEDEC standard, PCB, and copper-spreading area, and is only used as a relative measure of package thermal performance. Note that for a well-designed thermal layout,  $\theta_{JA}$  is actually the sum of the VQFN package junction-to-case (bottom) thermal resistance ( $\theta_{JCbot}$ ) plus the thermal resistance contribution by the PCB copper.

#### 8.1.6.1 Estimating Junction Temperature

The JEDEC standard now recommends the use of psi ( $\Psi$ ) thermal metrics to estimate the junction temperatures of the LDO when in-circuit on a typical PCB board application. These metrics are not strictly speaking thermal resistances, but rather offer practical and relative means of estimating junction temperatures. These psi metrics are determined to be significantly independent of the copper-spreading area. The key thermal metrics ( $\Psi_{JT}$  and  $\Psi_{JB}$ ) are given in the table and are used in accordance with [Equation 11](#).

$$\Psi_{JT}: T_J = T_T + \Psi_{JT} \times P_D$$

$$\Psi_{JB}: T_J = T_B + \Psi_{JB} \times P_D$$

where:

- $P_D$  is the power dissipated as explained in [Equation 8](#)
- $T_T$  is the temperature at the center-top of the device package, and
- $T_B$  is the PCB surface temperature measured 1 mm from the device package and centered on the package edge

(11)

### 8.1.6.2 Recommended Area for Continuous Operation (RACO)

The operational area of an LDO is limited by the dropout voltage, output current, junction temperature, and input voltage. The recommended area for continuous operation for a linear regulator can be separated into the following parts, and is shown in [Figure 55](#):

- Limited by dropout: Dropout voltage limits the minimum differential voltage between the input and the output ( $V_{INx} - V_{OUTx}$ ) at a given output current level; see the [Dropout Voltage \( \$V\_{DO}\$ \)](#) section for more details.
- Limited by rated output current: The rated output current limits the maximum recommended output current level. Exceeding this rating causes the device to fall out of specification.
- Limited by thermals: The shape of the slope is given by [Equation 10](#). The slope is nonlinear because the junction temperature of the LDO is controlled by the power dissipation across the LDO; therefore, when  $V_{INx} - V_{OUTx}$  increases, the output current must decrease in order to ensure that the rated junction temperature of the device is not exceeded. Exceeding this rating can cause the device to fall out of specifications and reduces long-term reliability.
- Limited by  $V_{INx}$  range: The rated input voltage range governs both the minimum and maximum of  $V_{INx} - V_{OUTx}$ .

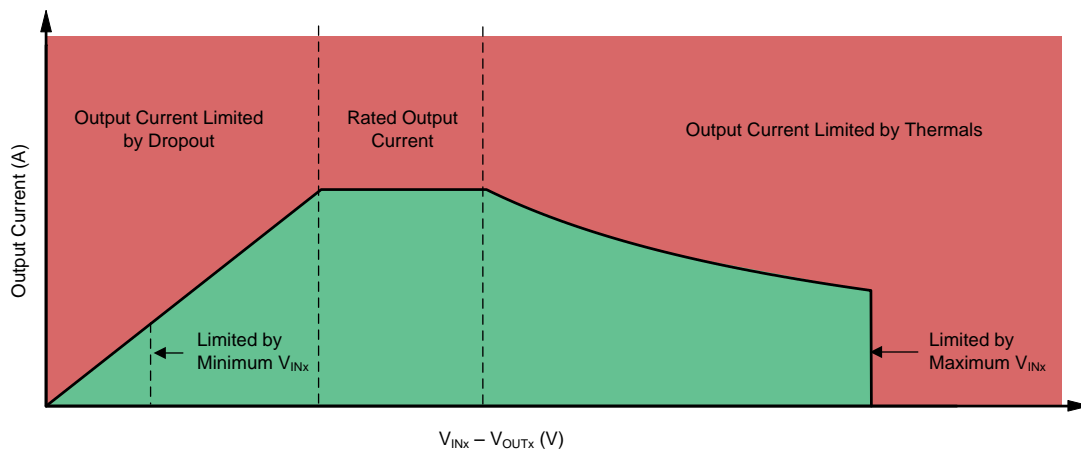

**Figure 55. Continuous Operation Slope Region Description**

Figure 56 to Figure 61 show the recommended area of operation curves for this device on a JEDEC-standard, high-K board with a  $\theta_{JA} = 35.4^{\circ}\text{C}/\text{W}$ , as given in the table.

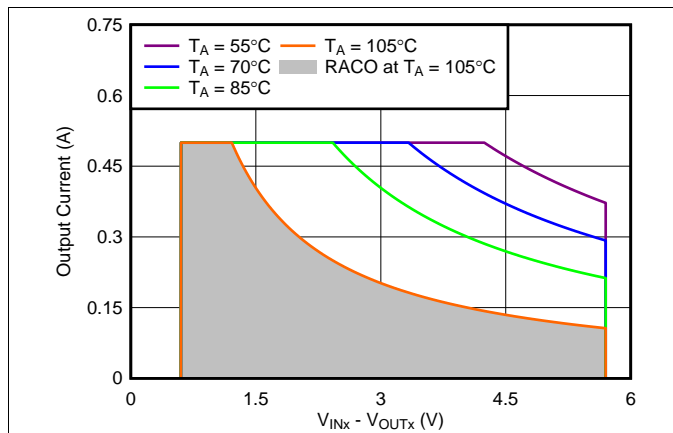

Figure 56. Recommended Area for Continuous Operation for  $V_{OUTX} = 0.8\text{ V}$

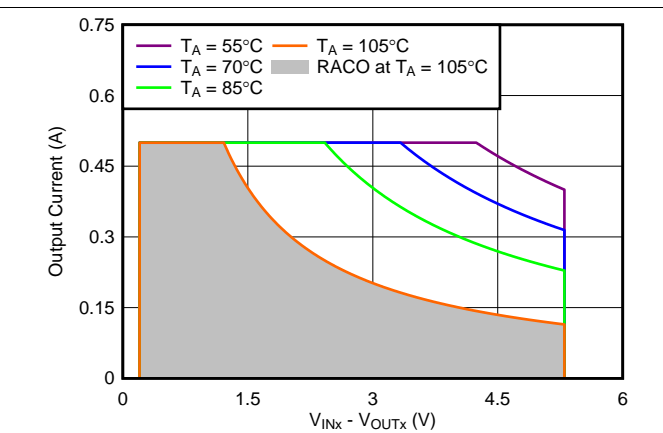

Figure 57. Recommended Area for Continuous Operation for  $V_{OUTX} = 1.2\text{ V}$

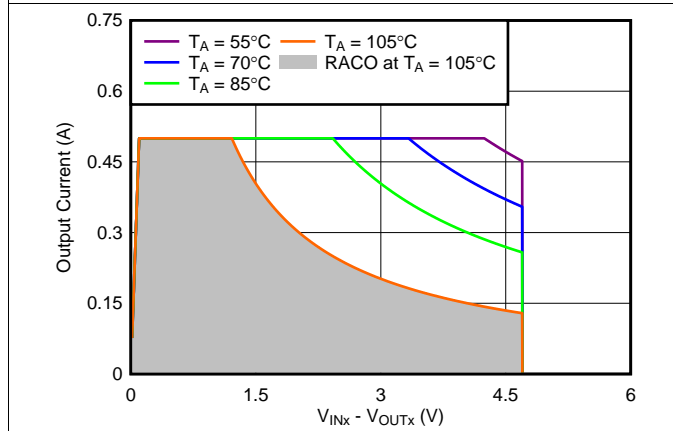

Figure 58. Recommended Area for Continuous Operation for  $V_{OUTX} = 1.8\text{ V}$

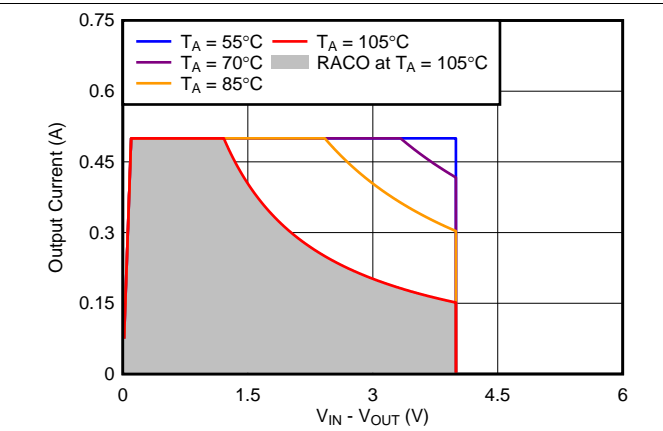

Figure 59. Recommended Area for Continuous Operation for  $V_{OUTX} = 2.5\text{ V}$

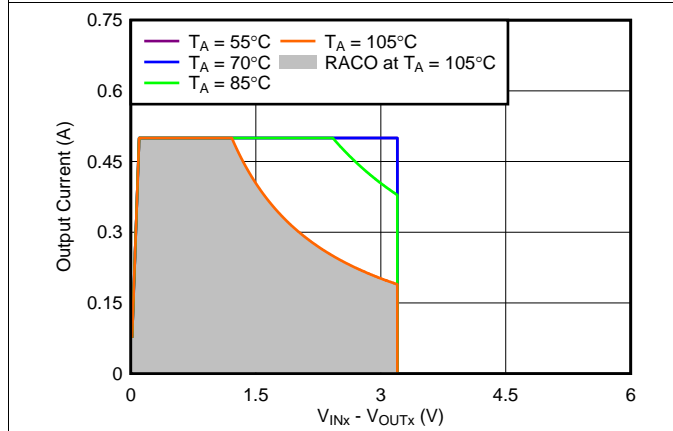

Figure 60. Recommended Area for Continuous Operation for  $V_{OUTX} = 3.3\text{ V}$

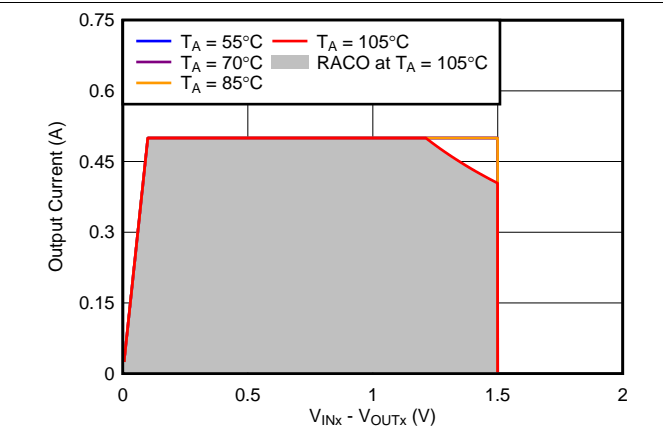
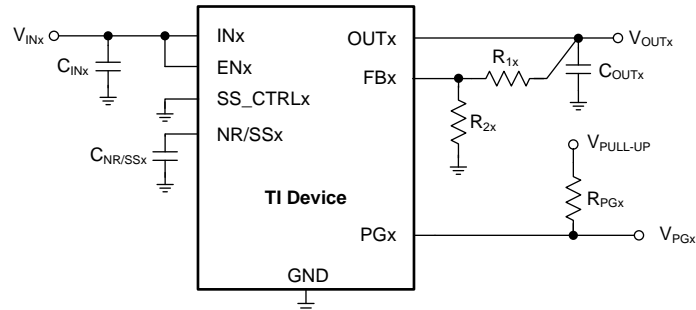

Figure 61. Recommended Area for Continuous Operation for  $V_{OUTX} = 5.0\text{ V}$

## 8.2 Typical Application

This section discusses the implementation of the TPS7A87 to regulate from a common input voltage to two output voltages of the same value. This application is common for when two noise-sensitive loads must have the same supply voltage but have high channel-to-channel isolation. The schematic for this application circuit is provided in [Figure 62](#).



Copyright © 2016, Texas Instruments Incorporated

**Figure 62. Application Example (Single Channel)**

### 8.2.1 Design Requirements

For the design example shown in [Figure 62](#), use the parameters listed in [Table 10](#) as the input parameters.

**Table 10. Design Parameters**

PARAMETER	DESIGN REQUIREMENT
Input voltages ( $V_{IN1}$ and $V_{IN2}$ )	1.8 V, $\pm 3\%$ , provided by the dc-dc converter switching at 750 kHz
Maximum ambient operating temperature	85°C
Output voltages ( $V_{OUT1}$ and $V_{OUT2}$ )	1.2 V, $\pm 1\%$ , output voltages are isolated
Output currents ( $I_{OUT1}$ and $I_{OUT2}$ )	400 mA (maximum), 10 mA (minimum)
Channel-to-channel isolation	Isolation greater than 50 dB at 100 kHz
RMS noise	$< 5 \mu V_{RMS}$ , bandwidth = 10 Hz to 100 kHz
PSRR at 750 kHz	$> 40$ dB
Startup time	$< 5$ ms

### 8.2.2 Detailed Design Procedure

The output voltages can be set to 1.2 V by selecting the correct values for  $R_{1x}$  and  $R_{2x}$ ; see [Equation 1](#).

Input and output capacitors are selected in accordance with the [External Component Selection](#) section. Ceramic capacitances of 10  $\mu F$  for both inputs and outputs are selected.

To minimize noise, a feed-forward capacitance ( $C_{FFx}$ ) of 10 nF is selected.

Channel-to-channel isolation depends greatly on the layout of the design. To minimize crosstalk between the outputs, keep the output capacitor grounds on separate sides of the design. See the [Layout](#) section for an example of how to layout the TPS7A87 to achieve best PSRR, channel-to-channel isolation, and noise.



### 8.2.3 Application Curves

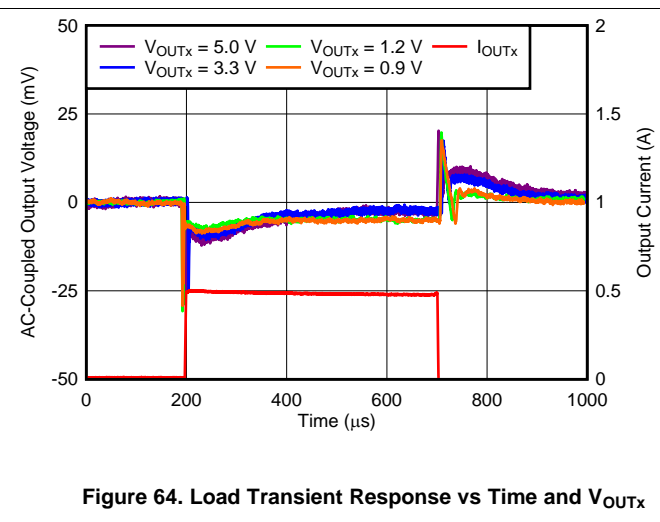
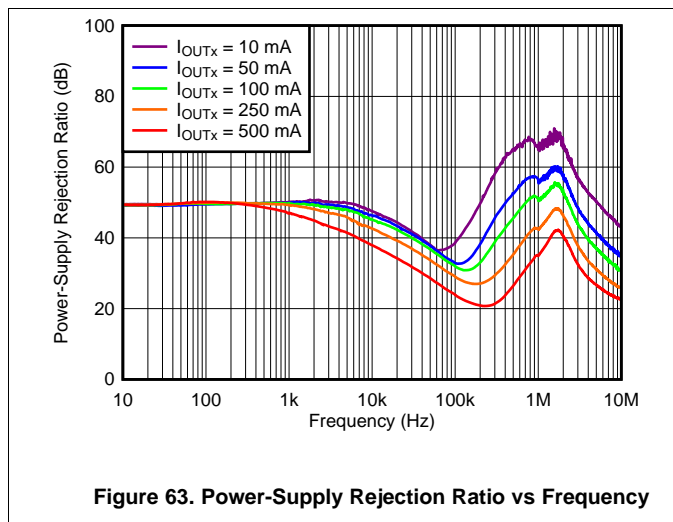

## 9 Power Supply Recommendations

Both inputs of the TPS7A87 are designed to operate from an input voltage range between 1.4 V and 6.5 V. The input voltage range must provide adequate headroom in order for the device to have a regulated output. This input supply must be well regulated. If the input supply is noisy or has a high output impedance, additional input capacitors with low ESR can help improve the output noise performance.

## 10 Layout

### 10.1 Layout Guidelines

General guidelines for linear regulator designs are to place all circuit components on the same side of the circuit board and as near as practical to the respective LDO pin connections. Place ground return connections to the input and output capacitor, and to the LDO ground pin as close to each other as possible, connected by a wide, component-side, copper surface. The use of vias and long traces to create LDO circuit connections is strongly discouraged and negatively affects system performance.

#### 10.1.1 Board Layout

To maximize the performance of the device, following the layout example illustrated in [Figure 65](#) is recommended. This layout isolates the analog ground (AGND) from the noisy power ground. Components that must be connected to the quiet analog ground are the noise-reduction capacitors ( $C_{NR/SSx}$ ) and the lower feedback resistors ( $R_{2x}$ ). These components must have a separate connection back to the thermal pad of the device. To minimize crosstalk between the two outputs, the output capacitor grounds are positioned on opposite sides of the layout and only connect back to the device at opposite sides of the thermal pad. Connecting the GND pins directly to the thermal pad and not to any external plane is recommended.

To maximize the output voltage accuracy, the connection from each output voltage back to the top output divider resistors ( $R_{1x}$ ) must be made as close as possible to the load. This method of connecting the feedback trace eliminates the voltage drop from the device output to the load.

To improve thermal performance, a 3 × 3 thermal via array must connect the thermal pad to internal ground planes. A larger area for the internal ground planes improves the thermal performance and lowers the operating temperature of the device.

## 10.2 Layout Example

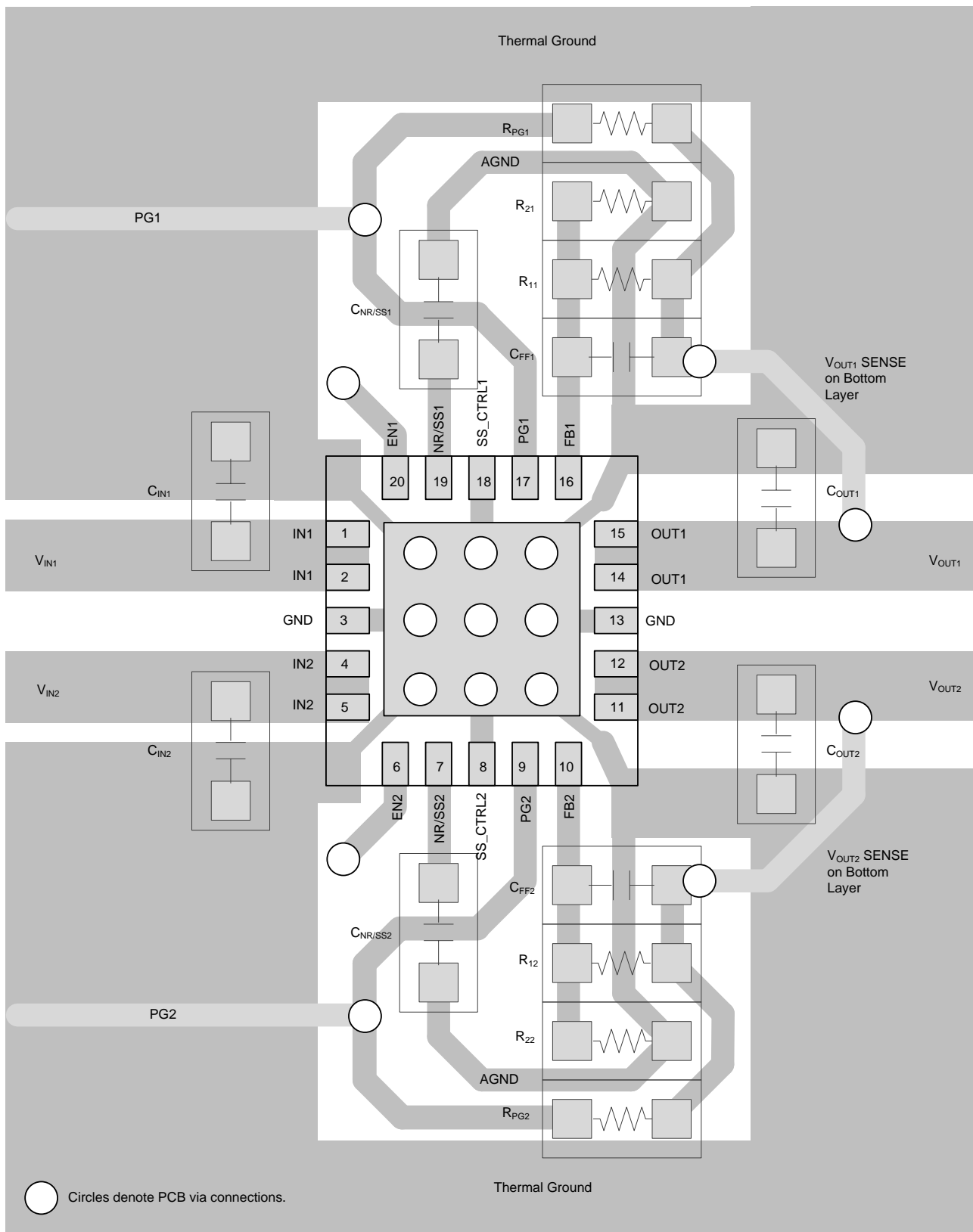

Figure 65. TPS7A87 Example Layout

## 11 Device and Documentation Support

### 11.1 Device Support

#### 11.1.1 Development Support

##### 11.1.1.1 Evaluation Modules

An evaluation module (EVM) is available to assist in the initial circuit performance evaluation using the TPS7A87. The summary information for this fixture is shown in [Table 11](#).

**Table 11. Design Kits & Evaluation Modules<sup>(1)</sup>**

NAME	PART NUMBER
TPS7A88 evaluation module	<a href="#">TPS7A88EVM User's Guide</a>

(1) For the most current package and ordering information see the Package Option Addendum at the end of this document, or see the device product folder at [www.ti.com](http://www.ti.com).

The EVM can be requested at the Texas Instruments web site ([www.ti.com](http://www.ti.com)) through the [TPS7A87 product folder](#).

##### 11.1.1.2 SPICE Models

Computer simulation of circuit performance using SPICE is often useful when analyzing the performance of analog circuits and systems. A SPICE model for the TPS7A87 is available through the TPS7A87 product folder under simulation models.

#### 11.1.2 Device Nomenclature

**Table 12. Ordering Information<sup>(1)</sup>**

PRODUCT	DESCRIPTION
TPS7A87XXYYYZ	<b>XX</b> represents the output voltage. 01 is the adjustable output version. <b>YYY</b> is the package designator. <b>Z</b> is the package quantity.

(1) For the most current package and ordering information see the Package Option Addendum at the end of this document, or see the device product folder at [www.ti.com](http://www.ti.com).

### 11.2 Documentation Support

#### 11.2.1 Related Documentation

For related documentation see the following:

- [TPS37xx Dual-Channel, Low-Power, High-Accuracy Voltage Detectors Data Sheet](#) (SBVS250)
- [TPS7A88 Evaluation Module User's Guide](#) (SBVU027)
- [Pros and Cons of Using a Feed-Forward Capacitor with a Low Dropout Regulator Application Report](#) (SBVA042)
- [How to Measure LDO Noise White Paper](#) (SLYY076)

#### 11.3 Receiving Notification of Documentation Updates

To receive notification of documentation updates, navigate to the device product folder on ti.com. In the upper right corner, click on *Alert me* to register and receive a weekly digest of any product information that has changed. For change details, review the revision history included in any revised document.

## 11.4 Community Resources

The following links connect to TI community resources. Linked contents are provided "AS IS" by the respective contributors. They do not constitute TI specifications and do not necessarily reflect TI's views; see TI's [Terms of Use](#).

**TI E2E™ Online Community** *TI's Engineer-to-Engineer (E2E) Community*. Created to foster collaboration among engineers. At [e2e.ti.com](http://e2e.ti.com), you can ask questions, share knowledge, explore ideas and help solve problems with fellow engineers.

**Design Support** *TI's Design Support* Quickly find helpful E2E forums along with design support tools and contact information for technical support.

## 11.5 Trademarks

E2E is a trademark of Texas Instruments.  
All other trademarks are the property of their respective owners.

## 11.6 Electrostatic Discharge Caution



This integrated circuit can be damaged by ESD. Texas Instruments recommends that all integrated circuits be handled with appropriate precautions. Failure to observe proper handling and installation procedures can cause damage.

ESD damage can range from subtle performance degradation to complete device failure. Precision integrated circuits may be more susceptible to damage because very small parametric changes could cause the device not to meet its published specifications.

## 11.7 Glossary

[SLYZ022](#) — *TI Glossary*.

This glossary lists and explains terms, acronyms, and definitions.

## 12 Mechanical, Packaging, and Orderable Information

The following pages include mechanical, packaging, and orderable information. This information is the most current data available for the designated devices. This data is subject to change without notice and revision of this document. For browser-based versions of this data sheet, refer to the left-hand navigation.

**PACKAGING INFORMATION**

Orderable part number	Status (1)	Material type (2)	Package   Pins	Package qty   Carrier	RoHS (3)	Lead finish/ Ball material (4)	MSL rating/ Peak reflow (5)	Op temp (°C)	Part marking (6)
<a href="#">TPS7A8701RTJR</a>	Active	Production	QFN (RTJ)   20	3000   LARGE T&R	Yes	NIPDAU	Level-1-260C-UNLIM	-40 to 125	TPS7A87
TPS7A8701RTJR.A	Active	Production	QFN (RTJ)   20	3000   LARGE T&R	Yes	NIPDAU	Level-1-260C-UNLIM	-40 to 125	TPS7A87
TPS7A8701RTJR.B	Active	Production	QFN (RTJ)   20	3000   LARGE T&R	Yes	NIPDAU	Level-1-260C-UNLIM	-40 to 125	TPS7A87
TPS7A8701RTJRG4	Active	Production	QFN (RTJ)   20	3000   LARGE T&R	Yes	NIPDAU	Level-1-260C-UNLIM	-40 to 125	TPS7A87
TPS7A8701RTJRG4.A	Active	Production	QFN (RTJ)   20	3000   LARGE T&R	Yes	NIPDAU	Level-1-260C-UNLIM	-40 to 125	TPS7A87
TPS7A8701RTJRG4.B	Active	Production	QFN (RTJ)   20	3000   LARGE T&R	Yes	NIPDAU	Level-1-260C-UNLIM	-40 to 125	TPS7A87
<a href="#">TPS7A8701RTJT</a>	Active	Production	QFN (RTJ)   20	250   SMALL T&R	Yes	NIPDAU	Level-1-260C-UNLIM	-40 to 125	TPS7A87
TPS7A8701RTJT.A	Active	Production	QFN (RTJ)   20	250   SMALL T&R	Yes	NIPDAU	Level-1-260C-UNLIM	-40 to 125	TPS7A87
TPS7A8701RTJT.B	Active	Production	QFN (RTJ)   20	250   SMALL T&R	Yes	NIPDAU	Level-1-260C-UNLIM	-40 to 125	TPS7A87

(1) **Status:** For more details on status, see our [product life cycle](#).

(2) **Material type:** When designated, preproduction parts are prototypes/experimental devices, and are not yet approved or released for full production. Testing and final process, including without limitation quality assurance, reliability performance testing, and/or process qualification, may not yet be complete, and this item is subject to further changes or possible discontinuation. If available for ordering, purchases will be subject to an additional waiver at checkout, and are intended for early internal evaluation purposes only. These items are sold without warranties of any kind.

(3) **RoHS values:** Yes, No, RoHS Exempt. See the [TI RoHS Statement](#) for additional information and value definition.

(4) **Lead finish/Ball material:** Parts may have multiple material finish options. Finish options are separated by a vertical ruled line. Lead finish/Ball material values may wrap to two lines if the finish value exceeds the maximum column width.

(5) **MSL rating/Peak reflow:** The moisture sensitivity level ratings and peak solder (reflow) temperatures. In the event that a part has multiple moisture sensitivity ratings, only the lowest level per JEDEC standards is shown. Refer to the shipping label for the actual reflow temperature that will be used to mount the part to the printed circuit board.

(6) **Part marking:** There may be an additional marking, which relates to the logo, the lot trace code information, or the environmental category of the part.

Multiple part markings will be inside parentheses. Only one part marking contained in parentheses and separated by a "-" will appear on a part. If a line is indented then it is a continuation of the previous line and the two combined represent the entire part marking for that device.

**Important Information and Disclaimer:**The information provided on this page represents TI's knowledge and belief as of the date that it is provided. TI bases its knowledge and belief on information provided by third parties, and makes no representation or warranty as to the accuracy of such information. Efforts are underway to better integrate information from third parties. TI has taken and continues to take reasonable steps to provide representative

and accurate information but may not have conducted destructive testing or chemical analysis on incoming materials and chemicals. TI and TI suppliers consider certain information to be proprietary, and thus CAS numbers and other limited information may not be available for release.

In no event shall TI's liability arising out of such information exceed the total purchase price of the TI part(s) at issue in this document sold by TI to Customer on an annual basis.

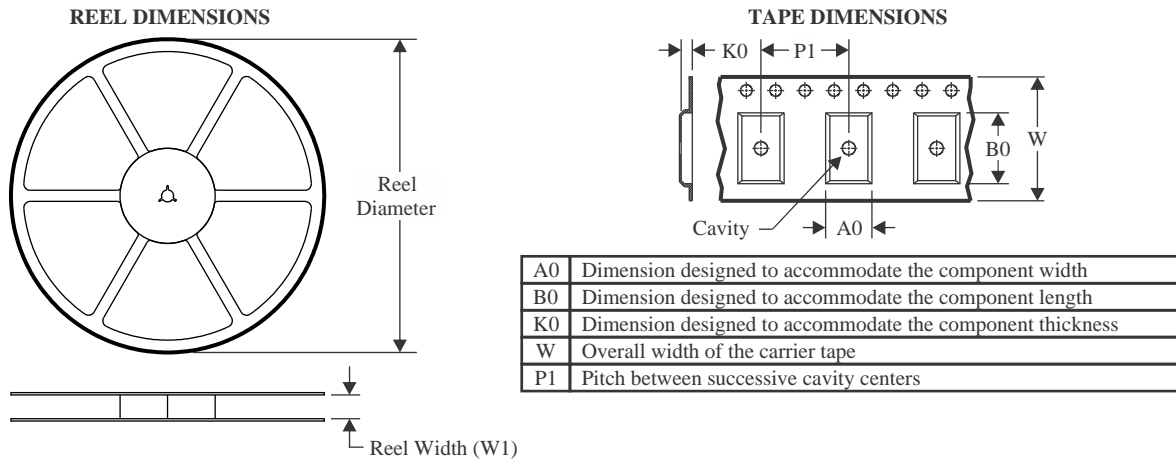
**TAPE AND REEL INFORMATION**

**QUADRANT ASSIGNMENTS FOR PIN 1 ORIENTATION IN TAPE**

\*All dimensions are nominal

Device	Package Type	Package Drawing	Pins	SPQ	Reel Diameter (mm)	Reel Width W1 (mm)	A0 (mm)	B0 (mm)	K0 (mm)	P1 (mm)	W (mm)	Pin1 Quadrant
TPS7A8701RTJR	QFN	RTJ	20	3000	330.0	12.4	4.25	4.25	1.15	8.0	12.0	Q2
TPS7A8701RTJRG4	QFN	RTJ	20	3000	330.0	12.4	4.25	4.25	1.15	8.0	12.0	Q2
TPS7A8701RTJT	QFN	RTJ	20	250	180.0	12.4	4.25	4.25	1.15	8.0	12.0	Q2



**TAPE AND REEL BOX DIMENSIONS**

\*All dimensions are nominal

Device	Package Type	Package Drawing	Pins	SPQ	Length (mm)	Width (mm)	Height (mm)
TPS7A8701RTJR	QFN	RTJ	20	3000	367.0	367.0	35.0
TPS7A8701RTJRG4	QFN	RTJ	20	3000	367.0	367.0	35.0
TPS7A8701RTJT	QFN	RTJ	20	250	210.0	185.0	35.0

## GENERIC PACKAGE VIEW

**RTJ 20**

**WQFN - 0.8 mm max height**

4 x 4, 0.5 mm pitch

PLASTIC QUAD FLATPACK - NO LEAD

This image is a representation of the package family, actual package may vary.  
Refer to the product data sheet for package details.

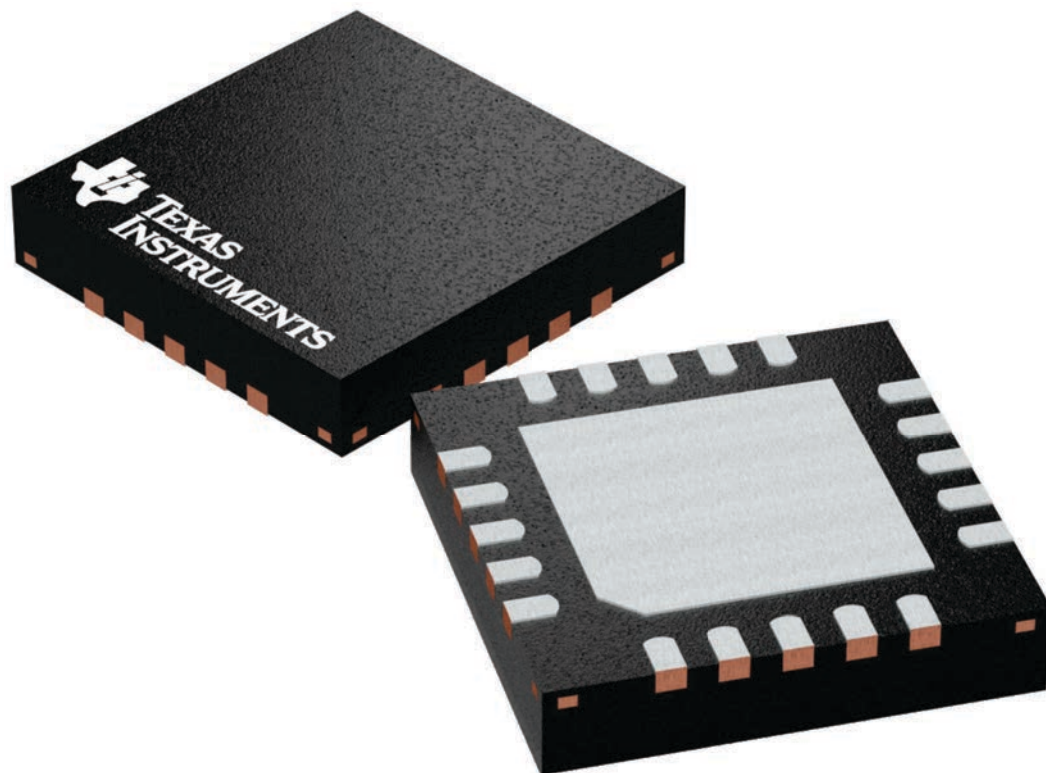

4224842/A

# DATA BOOK PACKAGE OUTLINE

LEADFRAME EXAMPLE
4222370

DRAFTSMAN: H. DENG	DATE: 09/12/2016		DIMENSIONS IN MILLIMETERS								
DESIGNER: H. DENG	DATE: 09/12/2016	 <b>TEXAS INSTRUMENTS</b> SEMICONDUCTOR OPERATIONS	CODE IDENTITY NUMBER 01295								
CHECKER: V. PAKU & T. LEQUANG	DATE: 09/12/2016		<b>ePOD, RTJ0020D / WQFN, 20 PIN, 0.5 MM PITCH</b>								
ENGINEER: T. TANG	DATE: 09/12/2016										
APPROVED: E. REY & D. CHIN	DATE: 10/06/2016										
RELEASED: WDM	DATE: 10/24/2016										
TEMPLATE INFO: EDGE# 4218519	DATE: 04/07/2016	<table border="1" style="display: inline-table; border-collapse: collapse;"> <tr> <td style="padding: 2px;">SCALE</td> <td style="padding: 2px;">SIZE</td> </tr> <tr> <td style="text-align: center;">15X</td> <td style="text-align: center;">A</td> </tr> </table>	SCALE	SIZE	15X	A	<table border="1" style="display: inline-table; border-collapse: collapse;"> <tr> <td style="padding: 2px;">REV</td> <td style="padding: 2px;">PAGE</td> </tr> <tr> <td style="text-align: center;">A</td> <td style="text-align: center;">1 OF 5</td> </tr> </table>	REV	PAGE	A	1 OF 5
SCALE	SIZE										
15X	A										
REV	PAGE										
A	1 OF 5										

4219125

# RTJ0020D

# PACKAGE OUTLINE

WQFN - 0.8 mm max height

PLASTIC QUAD FLATPACK - NO LEAD

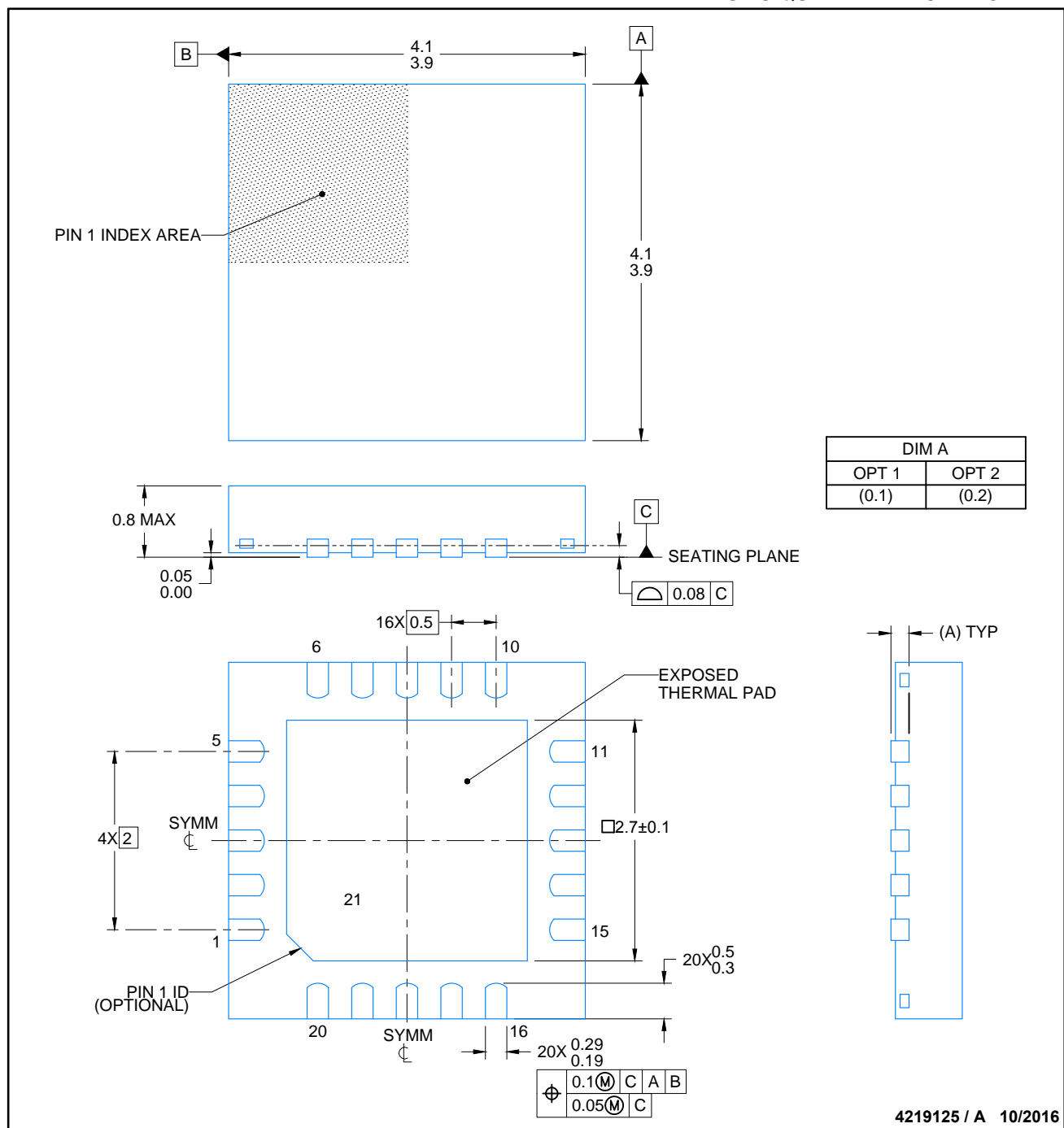

**NOTES:**

1. All linear dimensions are in millimeters. Any dimensions in parenthesis are for reference only. Dimensioning and tolerancing per ASME Y14.5M.
2. This drawing is subject to change without notice.
3. The package thermal pad must be soldered to the printed circuit board for thermal and mechanical performance.

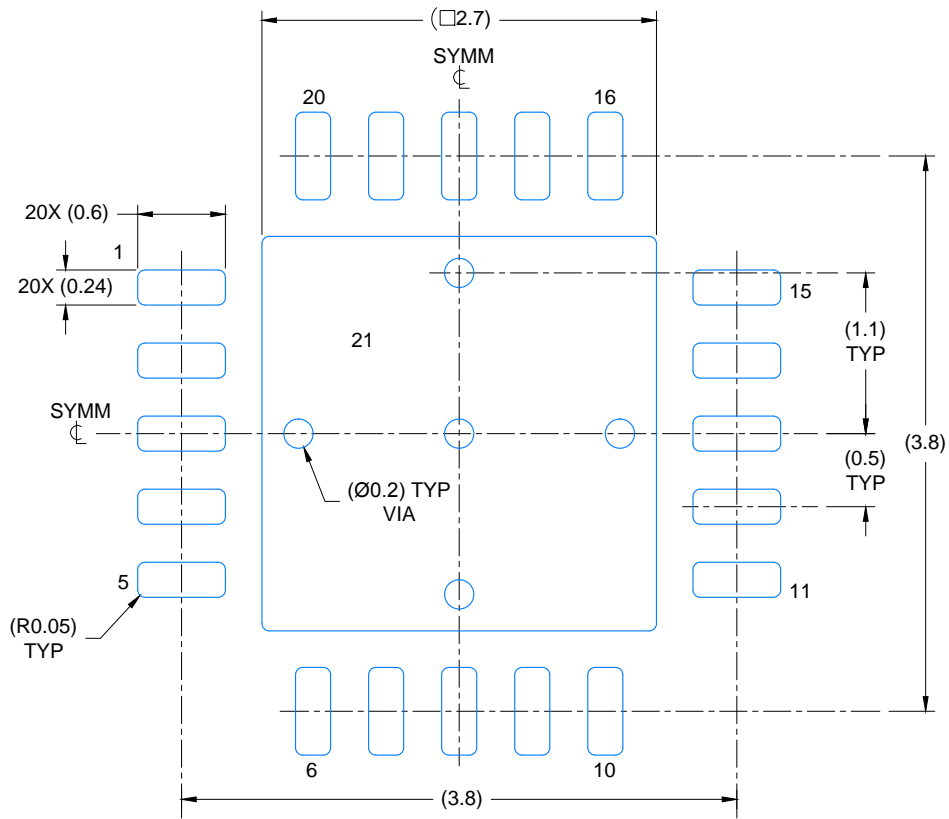

LAND PATTERN EXAMPLE  
SCALE: 20X

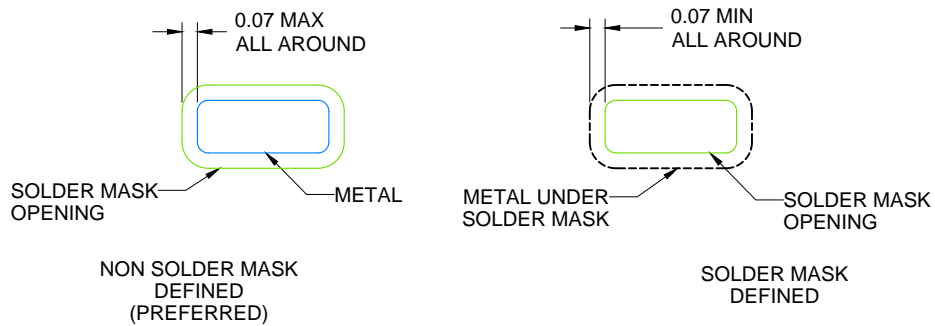

SOLDER MASK DETAILS

4219125 / A 10/2016

NOTES: (continued)

4. This package is designed to be soldered to a thermal pad on the board. For more information, see Texas Instruments literature number SLUA271 ([www.ti.com/lit/slua271](http://www.ti.com/lit/slua271)).
5. Vias are optional depending on application, refer to device data sheet. If any vias are implemented, refer to their locations shown on this view. It is recommended that vias under paste be filled, plugged or tented.

# EXAMPLE STENCIL DESIGN

WQFN - 0.8 mm max height

RTJ0020D

PLASTIC QUAD FLATPACK - NO LEAD

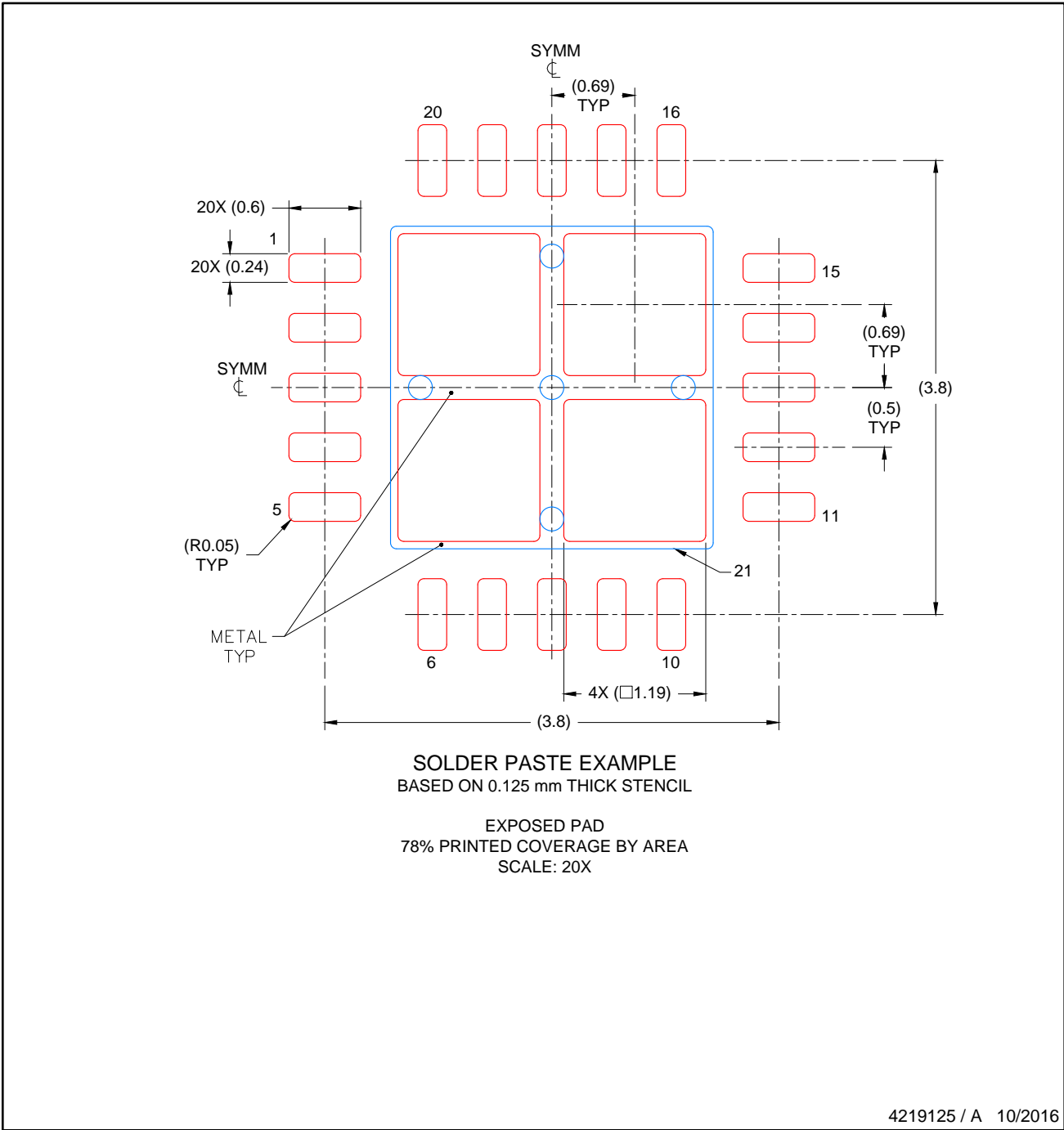

NOTES: (continued)

- 6. Laser cutting apertures with trapezoidal walls and rounded corners may offer better paste release. IPC-7525 may have alternate design recommendations..

# REVISIONS

REV	DESCRIPTION	ECR	DATE	ENGINEER / DRAFTSMAN
A	RELEASE NEW DRAWING	2160736	10/24/2016	T. TANG / H. DENG

Empty drawing area for revisions.

## IMPORTANT NOTICE AND DISCLAIMER

TI PROVIDES TECHNICAL AND RELIABILITY DATA (INCLUDING DATA SHEETS), DESIGN RESOURCES (INCLUDING REFERENCE DESIGNS), APPLICATION OR OTHER DESIGN ADVICE, WEB TOOLS, SAFETY INFORMATION, AND OTHER RESOURCES "AS IS" AND WITH ALL FAULTS, AND DISCLAIMS ALL WARRANTIES, EXPRESS AND IMPLIED, INCLUDING WITHOUT LIMITATION ANY IMPLIED WARRANTIES OF MERCHANTABILITY, FITNESS FOR A PARTICULAR PURPOSE OR NON-INFRINGEMENT OF THIRD PARTY INTELLECTUAL PROPERTY RIGHTS.

These resources are intended for skilled developers designing with TI products. You are solely responsible for (1) selecting the appropriate TI products for your application, (2) designing, validating and testing your application, and (3) ensuring your application meets applicable standards, and any other safety, security, regulatory or other requirements.

These resources are subject to change without notice. TI grants you permission to use these resources only for development of an application that uses the TI products described in the resource. Other reproduction and display of these resources is prohibited. No license is granted to any other TI intellectual property right or to any third party intellectual property right. TI disclaims responsibility for, and you will fully indemnify TI and its representatives against, any claims, damages, costs, losses, and liabilities arising out of your use of these resources.

TI's products are provided subject to [TI's Terms of Sale](#) or other applicable terms available either on [ti.com](https://www.ti.com) or provided in conjunction with such TI products. TI's provision of these resources does not expand or otherwise alter TI's applicable warranties or warranty disclaimers for TI products.

TI objects to and rejects any additional or different terms you may have proposed.

Mailing Address: Texas Instruments, Post Office Box 655303, Dallas, Texas 75265

Copyright © 2025, Texas Instruments Incorporated