

TPS797xx Ultra-Low I_Q , 50-mA Low-Dropout Linear Regulators With Power Good Output in SC70 Package

1 Features

- 50-mA Low-Dropout Regulator
- Ultra-Low 1.2- μ A Quiescent Current at 10 mA
- 5-Pin SC70 (DCK) Package
- Integrated Power Good Output
- Stable With Any Capacitor Greater Than 0.47 μ F
- Typical Dropout Voltage of 105 mV at 10 mA (TPS79733)
- Over-Current Limitation
- Operating Junction Temperature Range of -40°C to 85°C

2 Applications

- Battery-Powered Microcontrollers and Microprocessors

3 Description

The TPS797xx family of low-dropout voltage regulators (LDOs) offers the benefits of low-dropout voltage and ultra-low-power operation. The device is stable with any capacitor greater than 0.47- μ F. Therefore, implementations of this device require very little board space due to the miniaturized packaging and potentially small output capacitor. In addition, the family includes an integrated open drain active-high power good (PG) output. Intended for use in microcontroller-based, battery-powered applications, the TPS797xx family low dropout and ultra-low-power operation result in a significant increase in system battery operating life. The small packaging minimizes consumption of board space.

The device is enabled when the applied voltage exceeds the minimum input voltage. The usual PNP pass transistor has been replaced by a PMOS pass element. Because the PMOS pass element behaves as a low-value resistor, the dropout voltage is very low (typically, 105 mV at 10-mA of load current), and is directly proportional to the load current. The quiescent current is ultra-low (1.2- μ A, typically) and is stable over the entire range of output load current (0 mA to 50 mA). When properly configured with a pullup resistor, the PG output can implement a power-on reset or low-battery indicator.

Device Information⁽¹⁾

PART NUMBER	PACKAGE	BODY SIZE (NOM)
TPS797xx	SC70 (5)	2.00 mm x 1.25 mm

(1) For all available packages, see the orderable addendum at the end of the data sheet.

Ground Current vs Free-Air Temperature

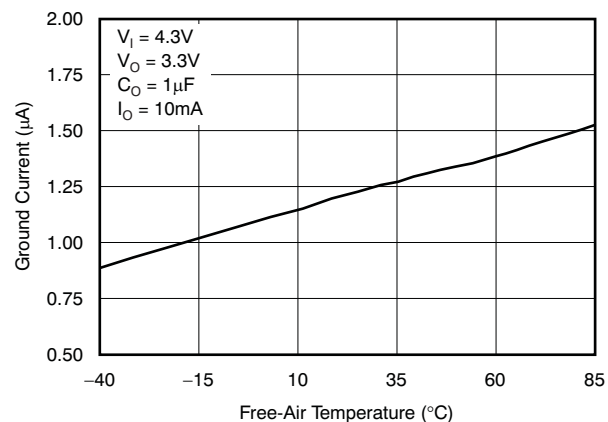
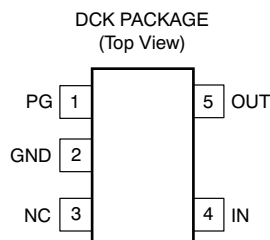

Table of Contents

1 Features	1	8 Application and Implementation	10
2 Applications	1	8.1 Application Information.....	10
3 Description	1	8.2 Typical Application	10
4 Revision History	2	9 Power-Supply Recommendations	12
5 Pin Configuration and Functions	4	10 Layout	12
6 Specifications	4	10.1 Layout Guidelines	12
6.1 Absolute Maximum Ratings	4	10.2 Layout Example	12
6.2 ESD Ratings.....	4	10.3 Power Dissipation and Junction Temperature	12
6.3 Recommended Operating Conditions.....	5	11 Device and Documentation Support	13
6.4 Thermal Information	5	11.1 Related Links	13
6.5 Electrical Characteristics.....	5	11.2 Receiving Notification of Documentation Updates	13
6.6 Typical Characteristics	7	11.3 Community Resources.....	13
7 Detailed Description	9	11.4 Trademarks	13
7.1 Overview	9	11.5 Electrostatic Discharge Caution.....	13
7.2 Functional Block Diagram	9	11.6 Glossary	13
7.3 Feature Description.....	9	12 Mechanical, Packaging, and Orderable Information	13
7.4 Device Functional Modes.....	9		

4 Revision History

NOTE: Page numbers for previous revisions may differ from page numbers in the current version.

Changes from Revision I (October 2013) to Revision J	Page
• Added ESD Ratings table, Feature Description section, Device Functional Modes, Application and Implementation section, Power Supply Recommendations section, Layout section, Device and Documentation Support section, and Mechanical, Packaging, and Orderable Information section	1
• Deleted Dissipation Ratings table; see Thermal Information table.....	4
• Added Thermal Information table	5
• Changed Load Regulation parameter unit From: mV To: %/A.....	5
• Changed Output Spectral Noise Density vs Frequency graph Y-axis unit From: nV/√Hz To: μV/√Hz	7
• Changed IOUTx values From: I _{CL} To: I _{SC}	9

Changes from Revision H (April 2012) to Revision I	Page
• Changed Dropout Voltage vs Junction Temperature graph Y-axis unit From: V To: mV (typo)	8

Changes from Revision G (November 2009) to Revision H	Page
• Deleted sentence regarding thermal protection.....	12

Changes from Revision F (May 2009) to Revision G	Page
• Changed document title.....	1
• Deleted references to SOT323 package throughout document.....	1
• Changed Test Conditions for Electrical Characteristics table	5
• Changed output voltage accuracy test conditions from 10 μA < I _{OUT} < 10 mA to 1 mA < I _{OUT} < 10 mA	5
• Deleted line regulation maximum specification	5
• Changed PG trip threshold voltage test conditions from V _{OUT} decreasing to V _{OUT} increasing; deleted minimum and maximum specifications.....	5
• Revised PG low output low voltage test conditions.....	5

- Updated PG leakage current test conditions 5

5 Pin Configuration and Functions

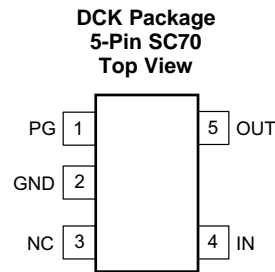

Pin Functions

PIN		I/O	DESCRIPTION
NO.	NAME		
1	PG	O	The PG pin for the fixed voltage option devices is an open drain, active-high output that indicates the status of V_O (output of the LDO). When V_O exceeds approximately 90% of the regulated voltage, PG goes to a high-impedance state. PG goes to a low-impedance state when V_O falls below approximately 90% (that is, overload condition) of the regulated voltage. The open drain output of the PG pin requires a pullup resistor.
2	GND	—	Ground
3	NC	—	No connection
4	IN	I	The IN pin is the power-supply input to the device.
5	OUT	O	The OUT pin provides the regulated output voltage of the device.

6 Specifications

6.1 Absolute Maximum Ratings

over operating free-air temperature range (unless otherwise noted) ⁽¹⁾

		MIN	MAX	UNIT
Voltage	Input voltage ⁽²⁾	-0.3	6	V
	Maximum dc output voltage		4.9	V
Current	Peak output current	Internally limited		A
Temperature	Operating virtual junction temperature, T_J	-40	85	°C
	Storage temperature, T_{stg}	-65	150	°C

- (1) Stresses beyond those listed under *Absolute Maximum Ratings* may cause permanent damage to the device. These are stress ratings only, which do not imply functional operation of the device at these or any other conditions beyond those indicated under *Recommended Operating Conditions*. Exposure to absolute-maximum-rated conditions for extended periods may affect device reliability.
- (2) All voltage values are with respect to network ground pin.

6.2 ESD Ratings

		VALUE	UNIT
$V_{(ESD)}$ Electrostatic discharge	Human-body model (HBM), per ANSI/ESDA/JEDEC JS-001 ⁽¹⁾	±2000	V
	Charged-device model (CDM), per JEDEC specification JESD22-C101 ⁽²⁾	±500	

- (1) JEDEC document JEP155 states that 500-V HBM allows safe manufacturing with a standard ESD control process.
- (2) JEDEC document JEP157 states that 250-V CDM allows safe manufacturing with a standard ESD control process.

6.3 Recommended Operating Conditions

over operating free-air temperature range (unless otherwise noted)

		MIN	NOM	MAX	UNIT
V_I	Input voltage	1.8		5.5	V
V_O	Output voltage	1.8		3.3	V
I_O	Output current	0		50	mA
C_I	Input capacitor	0	0.1		μ F
C_O	Output capacitor	0.47	1		μ F
T_J	Junction temperature	-40		85	$^{\circ}$ C

6.4 Thermal Information

THERMAL METRIC ⁽¹⁾		TPS797xx	UNIT
		DCK (SC70)	
		5 PINS	
$R_{\theta JA}$	Junction-to-ambient thermal resistance	230.9	$^{\circ}$ C/W
$R_{\theta JC(top)}$	Junction-to-case (top) thermal resistance	98.3	$^{\circ}$ C/W
$R_{\theta JB}$	Junction-to-board thermal resistance	70.7	$^{\circ}$ C/W
Ψ_{JT}	Junction-to-top characterization parameter	3.9	$^{\circ}$ C/W
Ψ_{JB}	Junction-to-board characterization parameter	70.1	$^{\circ}$ C/W
$R_{\theta JC(bot)}$	Junction-to-case (bottom) thermal resistance	—	$^{\circ}$ C/W

(1) For more information about traditional and new thermal metrics, see [Semiconductor and IC Package Thermal Metrics](#) (SPRA953).

6.5 Electrical Characteristics

over operating temperature range $T_J = -40^{\circ}$ C to 85° C, typical values are at $T_A = 25^{\circ}$ C, $V_I = V_{O(typ)} + 0.5$ V or 2 V (whichever is greater); $I_O = 0.5$ mA, V_{SET} , $V_{EN} = V_I$, and $C_O = 1$ μ F (unless otherwise noted)

PARAMETER	TEST CONDITIONS	MIN	TYP	MAX	UNIT
V_I	Input voltage ⁽¹⁾	$I_O = 3$ mA		5.5	V
		$I_O = 10$ mA	2	5.5	
I_O	Continuous output current ⁽²⁾	0		50	mA
V_O	Output voltage accuracy ⁽³⁾	$V_O + 1$ V $\leq V_I \leq 5.5$ V 1 mA $< I_O < 10$ mA		4%	
$\Delta V_{O(\Delta V_I)}$	Line regulation ⁽³⁾	$V_O + 1$ V $\leq V_I \leq 5.5$ V	0.15%		V
$\Delta V_{O(\Delta I_O)}$	Load regulation	1 μ A $< I_O < 10$ mA	5%		A
$V_{(DO)}$	Dropout voltage ⁽⁴⁾ , $I_O = 10$ mA $V_I = V_{O(NOM)} - 0.1$ V	TPS79730	110	200	mV
		TPS79733	105	200	
I_{SC}	Output current limit	$V_O = 0$ V	190	300	mA
$I_{(GND)}$	Ground pin current ⁽³⁾	$I_O = 10$ mA	1.2	2	μ A
PSRR	Power-supply rejection ratio (ripple rejection)	$f = 100$ Hz, $C_O = 10$ μ F, $I_O = 10$ mA	50		dB
V_n	Output noise voltage (TPS79718)	BW = 200 kHz to 100 kHz, $C_O = 10$ μ F, $I_O = 10$ mA	600		μ V _{RMS}
$V_{Imin(PG)}$	Minimum input voltage for valid PG	$V_{(PG)} \geq 0.8$ V, $I_{PG} = 100$ μ A	1.2		V
V_{IT}	PG trip threshold voltage	V_{OUT} increasing	90%		V_{OUT}
$V_{OL(PG)}$	PG output low voltage	$V_I = 1.4$ V, $I_{PG} = 30$ μ A, $I_O = 1$ mA	0.14	0.225	V
$I_{lkg(PG)}$	PG leakage current	$V_{(PG)} = 5$ V, $V_I = V_O + 1$ V, $I_O = 1$ mA	0.1		nA

(1) Minimum $V_I = V_O + V_{(DO)}$ or the minimum value specified here, whichever is greater.

(2) Continuous output current is limited by internal protection circuitry, but it is not recommended that the device operate above this maximum for extended periods of time.

(3) Minimum V_I is specified in ⁽¹⁾.

(4) $V_{(DO)}$ is not measured for the TPS79718 because minimum $V_I > 1.7$ V.

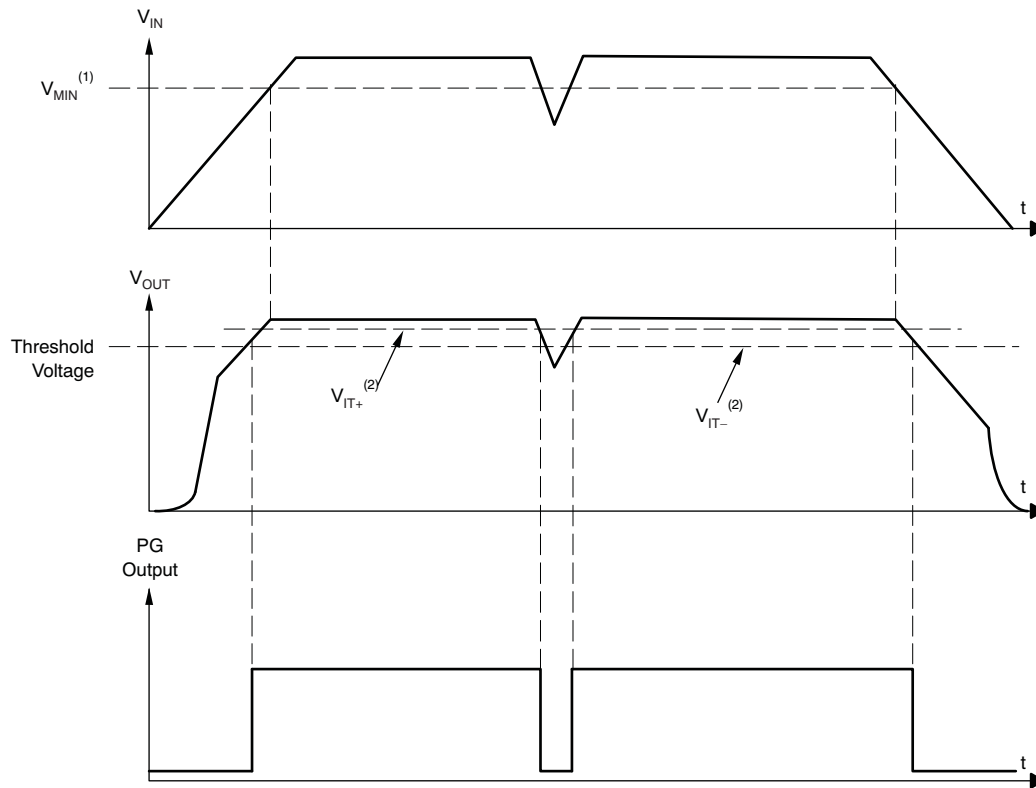

NOTES: (1) $V_{MIN} = V_{OUT} + V_{DO}$.

(2) The PG trip voltage is typically 10% lower than the output voltage (90% V_O). V_{IT+} to V_{IT-} is the hysteresis voltage.

Figure 1. TPS797xx PG Timing Diagram

6.6 Typical Characteristics

over operating temperature range $T_J = -40^{\circ}\text{C}$ to 85°C , typical values are at $T_A = 25^{\circ}\text{C}$, $V_I = V_O$ (typical) + 0.5 V or 2 V (whichever is greater); $I_O = 0.5$ mA, $V_{EN} = V_I$, and $C_O = 1$ μF (unless otherwise noted).

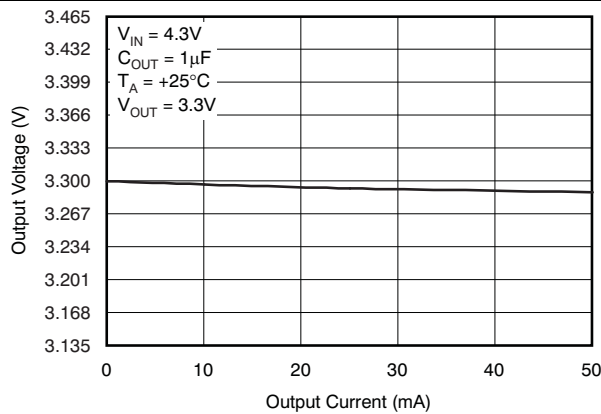

Figure 2. Output Voltage vs Output Current

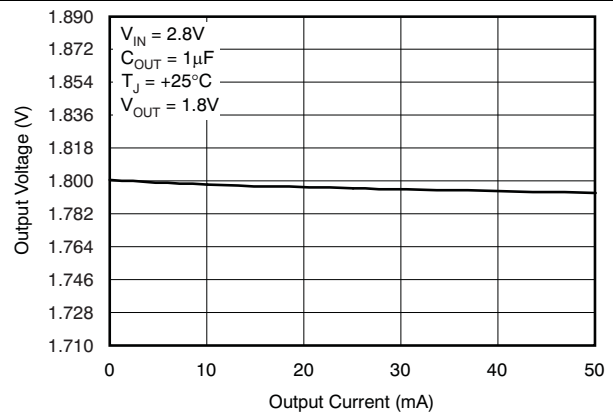

Figure 3. Output Voltage vs Output Current

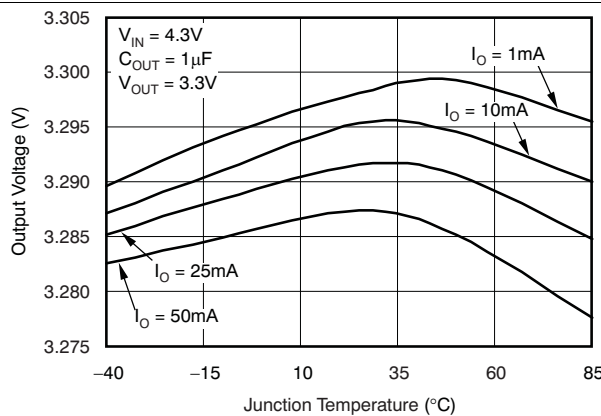

Figure 4. Output Voltage vs Junction Temperature

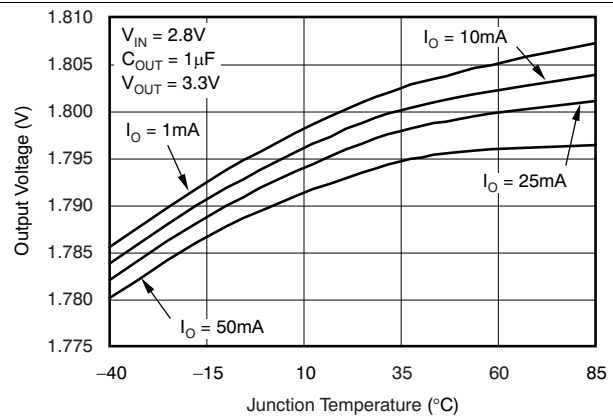

Figure 5. Output Voltage vs Junction Temperature

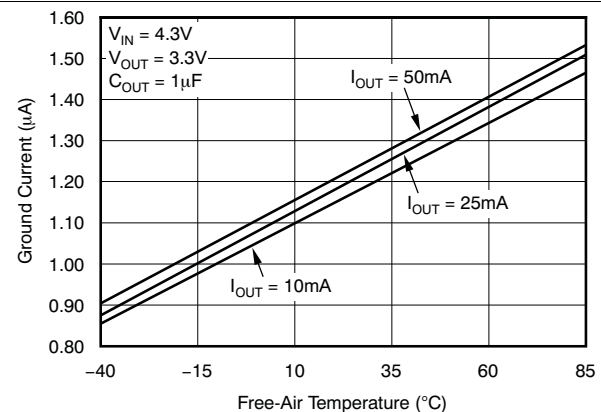

Figure 6. Ground Current vs Junction Temperature

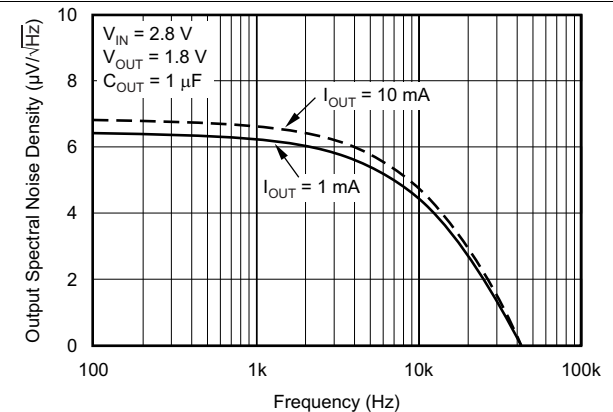

Figure 7. Output Spectral Noise Density vs Frequency

Typical Characteristics (continued)

over operating temperature range $T_J = -40^{\circ}\text{C}$ to 85°C , typical values are at $T_A = 25^{\circ}\text{C}$, $V_I = V_O$ (typical) + 0.5 V or 2 V (whichever is greater); $I_O = 0.5$ mA, $V_{EN} = V_I$, and $C_O = 1$ μF (unless otherwise noted).

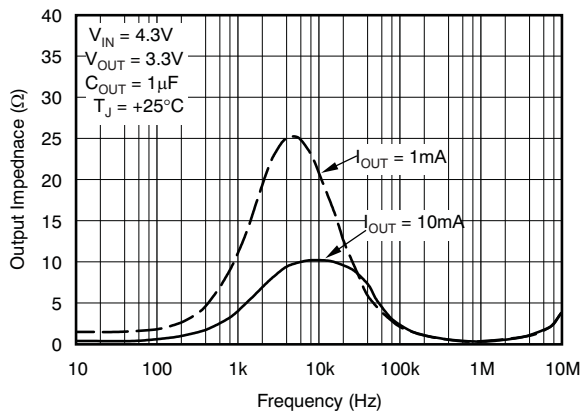

Figure 8. Output Impedance vs Frequency

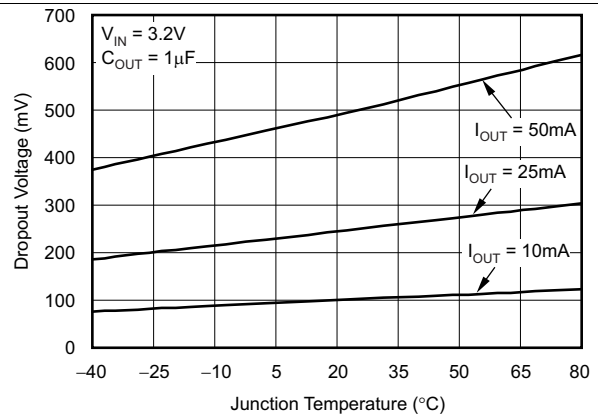

Figure 9. Dropout Voltage vs Junction Temperature

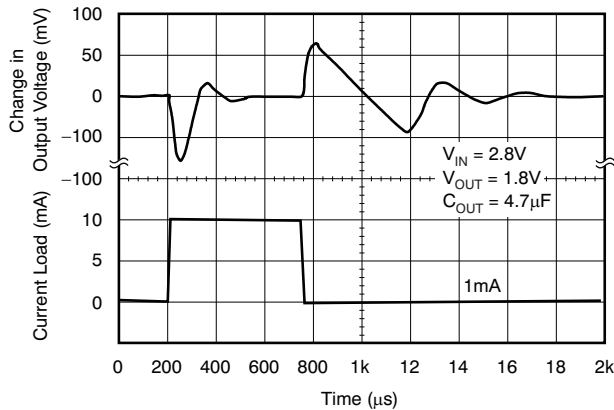

Figure 10. TPS79718 Load Transient Response

7 Detailed Description

7.1 Overview

The TPS797xx devices offer a low-dropout voltage, ultra-low-power operation, and are stable with any capacitor greater than 0.47 μF , and contains an integrated open-drain power good (PG) output.

7.2 Functional Block Diagram

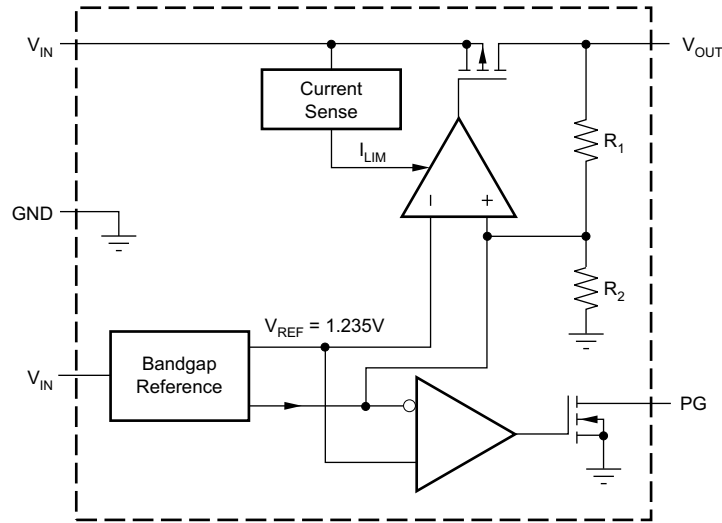

Copyright © 2016, Texas Instruments Incorporated

7.3 Feature Description

7.3.1 Regulator Protection

The TPS797xx PMOS-pass transistor has a built-in back diode that conducts reverse current when the input voltage drops below the output voltage (for example, during power down). Current is conducted from the output to the input and is not internally limited. If extended reverse voltage operation is anticipated, external limiting might be appropriate.

The TPS797xx features internal current limiting. During normal operation, the TPS797xx limits output current to approximately 190 mA. When current limiting engages, the output voltage scales back linearly until the overcurrent condition ends. Take care not to exceed the power dissipation ratings of the package.

7.4 Device Functional Modes

Table 1 provides a quick comparison between the normal, dropout, and disabled modes of operation.

Table 1. Device Modes Comparison

OPERATING MODE	PARAMETER	
	V_I	I_{OUTx}
Normal ⁽¹⁾	$V_I > V_O + V_{(DO)}$	$I_{OUTx} < I_{SC}$
Dropout ⁽¹⁾	$V_I < V_O + V_{(DO)}$	$I_{OUTx} < I_{SC}$

(1) All table conditions must be met.

8 Application and Implementation

NOTE

Information in the following applications sections is not part of the TI component specification, and TI does not warrant its accuracy or completeness. TI's customers are responsible for determining suitability of components for their purposes. Customers should validate and test their design implementation to confirm system functionality.

8.1 Application Information

The TPS797xx family of low-dropout (LDO) regulators are optimized for micropower applications. The family features extremely low dropout voltages and ultra-low quiescent current (typically 1.2- μA).

8.2 Typical Application

8.2.1 Powering Microcontrollers

This device is suited to provide a regulated input voltage and power good (PG) supervisory signal to low-power devices such as mixed-signal microcontrollers. The quiescent (or ground) current of the TPS797xx family is typically 1.2 μA , even at full load; therefore, the reduction in battery life by including the TPS797xx in the system is negligible.

Figure 11 shows an application where the TPS79718 powers TI's MSP430 mixed signal microcontroller.

Minimal board space is required to accommodate the DCK (SC70) packaged TPS79718, the 0.1- μF output capacitor, the 0.47- μF input capacitor, and the pullup resistor on the PG pin.

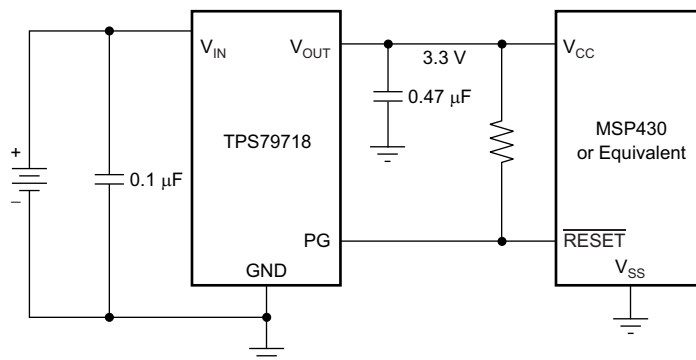

Copyright © 2016, Texas Instruments Incorporated

Figure 11. MSP430 Microcontroller Powered by the TPS79718 Regulator Diagram

8.2.1.1 Design Requirements

Table 2 lists the design parameters for this example.

Table 2. Design Parameters

PARAMETER	VALUE
Input voltage range	3.5 V to 5.5 V
Output voltage	3.3 V
Output current rating	50 mA
Minimum output capacitor	0.47 μF

8.2.1.2 Detailed Design Procedure

8.2.1.2.1 External Capacitor Requirements

Although not required, an input bypass capacitor with a value of 0.1- μF or larger (connected between IN and GND and placed close to the TPS797xx) is recommended, especially when a highly resistive power supply is powering the LDO in addition to other devices. Like all low-dropout regulators, the TPS797xx requires an output capacitor connected between OUT and GND to stabilize the internal control loop. The minimum recommended capacitance is 0.47- μF . Any 0.47- μF capacitor is suitable, and capacitor values larger than 0.47- μF are acceptable.

8.2.1.3 Application Curves

over operating temperature range $T_J = -40^\circ\text{C}$ to 85°C , typical values are at $T_A = 25^\circ\text{C}$, $V_I = V_O$ (typical) + 0.5 V or 2 V (whichever is greater); $I_O = 0.5$ mA, $V_{EN} = V_I$, and $C_O = 1$ μF (unless otherwise noted)

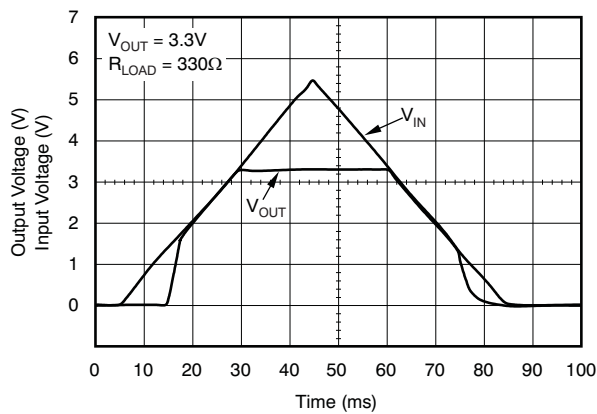
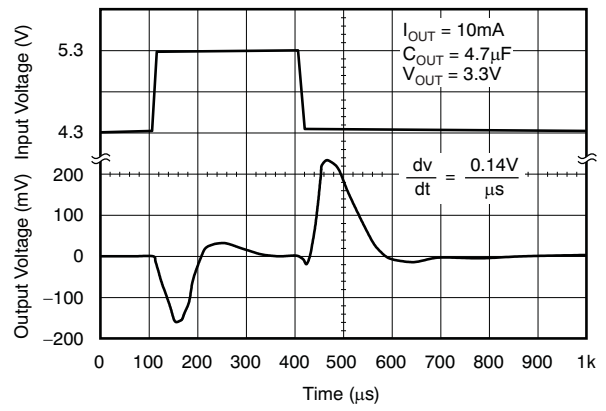
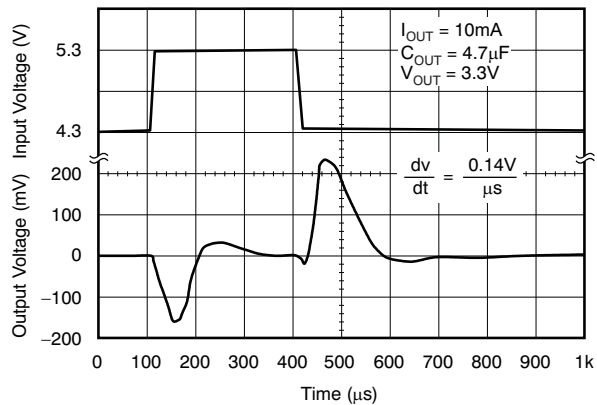
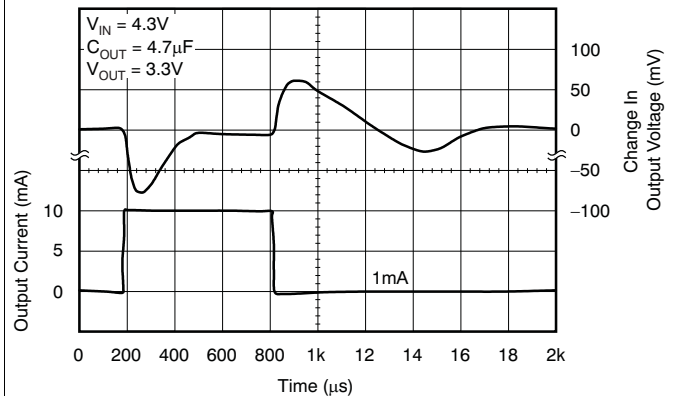
Figure 12. Power Up and Power Down

Figure 13. TPS79718 Line Transient Response

Figure 14. TPS79733 Line Transient Response

Figure 15. TPS79733 Load Transient Response

9 Power-Supply Recommendations

The TPS797xx is designed to operate from an input voltage range between 1.8 V and 5.5 V. The input voltage range must provide adequate headroom for the device to have a regulated output. This input supply must be well regulated. If the input supply is noisy, additional input capacitors with low ESR can help improve the output noise performance.

10 Layout

10.1 Layout Guidelines

General guidelines for linear regulator designs are to place all circuit components on the same side of the circuit board and as near as practical to the respective LDO pin connections. Place ground return connections to the input and output capacitor, and to the LDO ground pin as close to each other as possible, connected by a wide, component-side, copper surface. The use of vias and long traces to create LDO circuit connections is strongly discouraged and negatively affects system performance.

10.2 Layout Example

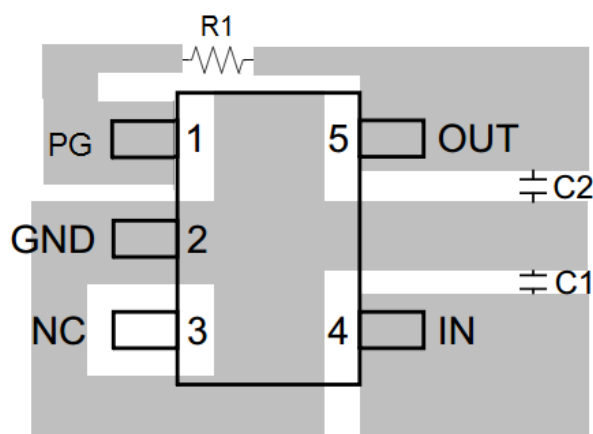

Figure 16. Layout Example

10.3 Power Dissipation and Junction Temperature

Specified regulator operation is ensured for a junction temperature of up to 85°C; restrict the maximum junction temperature to 85°C under normal operating conditions. This restriction limits the power dissipation the regulator can handle in any given application. To ensure the junction temperature is within acceptable limits, calculate the maximum allowable dissipation ($P_{D(MAX)}$) and the actual dissipation (P_D), which must be less than or equal to $P_{D(MAX)}$.

The maximum-power-dissipation limit is determined using [Equation 1](#).

$$P_{D(max)} = \frac{T_{J(max)} - T_A}{R_{\theta JA}}$$

where

- $T_{J(max)}$ is the maximum allowable junction temperature
 - $R_{\theta JA}$ is the thermal resistance junction-to-ambient for the package (see [Thermal Information](#))
 - T_A is the ambient temperature
- (1)

The regulator dissipation is calculated using [Equation 2](#).

$$P_D = (V_I - V_O) \times I_O$$
(2)

Power dissipation resulting from quiescent current is negligible.

11 Device and Documentation Support

11.1 Related Links

[Table 3](#) lists quick access links. Categories include technical documents, support and community resources, tools and software, and quick access to sample or buy.

Table 3. Related Links

PARTS	PRODUCT FOLDER	SAMPLE & BUY	TECHNICAL DOCUMENTS	TOOLS & SOFTWARE	SUPPORT & COMMUNITY
TPS79718	Click here	Click here	Click here	Click here	Click here
TPS797285	Click here	Click here	Click here	Click here	Click here
TPS79730	Click here	Click here	Click here	Click here	Click here
TPS79733	Click here	Click here	Click here	Click here	Click here

11.2 Receiving Notification of Documentation Updates

To receive notification of documentation updates, navigate to the device product folder on ti.com. In the upper right corner, click on *Alert me* to register and receive a weekly digest of any product information that has changed. For change details, review the revision history included in any revised document.

11.3 Community Resources

The following links connect to TI community resources. Linked contents are provided "AS IS" by the respective contributors. They do not constitute TI specifications and do not necessarily reflect TI's views; see TI's [Terms of Use](#).

TI E2E™ Online Community *TI's Engineer-to-Engineer (E2E) Community*. Created to foster collaboration among engineers. At e2e.ti.com, you can ask questions, share knowledge, explore ideas and help solve problems with fellow engineers.

Design Support *TI's Design Support* Quickly find helpful E2E forums along with design support tools and contact information for technical support.

11.4 Trademarks

E2E is a trademark of Texas Instruments.
All other trademarks are the property of their respective owners.

11.5 Electrostatic Discharge Caution



These devices have limited built-in ESD protection. The leads should be shorted together or the device placed in conductive foam during storage or handling to prevent electrostatic damage to the MOS gates.

11.6 Glossary

[SLYZ022](#) — *TI Glossary*.

This glossary lists and explains terms, acronyms, and definitions.

12 Mechanical, Packaging, and Orderable Information

The following pages include mechanical, packaging, and orderable information. This information is the most current data available for the designated devices. This data is subject to change without notice and revision of this document. For browser-based versions of this data sheet, refer to the left-hand navigation.

PACKAGING INFORMATION

Orderable part number	Status (1)	Material type (2)	Package Pins	Package qty Carrier	RoHS (3)	Lead finish/ Ball material (4)	MSL rating/ Peak reflow (5)	Op temp (°C)	Part marking (6)
TPS79718DCKR	Active	Production	SC70 (DCK) 5	3000 LARGE T&R	Yes	NIPDAU NIPDAUAG	Level-1-260C-UNLIM	-40 to 85	ATD
TPS79718DCKR.A	Active	Production	SC70 (DCK) 5	3000 LARGE T&R	Yes	NIPDAUAG	Level-1-260C-UNLIM	-40 to 85	ATD
TPS79718DCKT	Active	Production	SC70 (DCK) 5	250 SMALL T&R	Yes	NIPDAU NIPDAUAG	Level-1-260C-UNLIM	-40 to 85	ATD
TPS79718DCKT.A	Active	Production	SC70 (DCK) 5	250 SMALL T&R	Yes	NIPDAUAG	Level-1-260C-UNLIM	-40 to 85	ATD
TPS79718DCKTG4	Active	Production	SC70 (DCK) 5	250 SMALL T&R	Yes	NIPDAUAG	Level-1-260C-UNLIM	-40 to 85	ATD
TPS797285DCKR	Active	Production	SC70 (DCK) 5	3000 LARGE T&R	Yes	NIPDAUAG	Level-1-260C-UNLIM	-40 to 85	OEB
TPS797285DCKR.A	Active	Production	SC70 (DCK) 5	3000 LARGE T&R	Yes	NIPDAUAG	Level-1-260C-UNLIM	-40 to 85	OEB
TPS797285DCKT	Active	Production	SC70 (DCK) 5	250 SMALL T&R	Yes	NIPDAUAG	Level-1-260C-UNLIM	-40 to 85	OEB
TPS797285DCKT.A	Active	Production	SC70 (DCK) 5	250 SMALL T&R	Yes	NIPDAUAG	Level-1-260C-UNLIM	-40 to 85	OEB
TPS79730DCKR	Active	Production	SC70 (DCK) 5	3000 LARGE T&R	Yes	NIPDAU NIPDAUAG	Level-1-260C-UNLIM	-40 to 85	ATE
TPS79730DCKR.A	Active	Production	SC70 (DCK) 5	3000 LARGE T&R	Yes	NIPDAUAG	Level-1-260C-UNLIM	-40 to 85	ATE
TPS79730DCKRG4	Active	Production	SC70 (DCK) 5	3000 LARGE T&R	Yes	NIPDAUAG	Level-1-260C-UNLIM	-40 to 85	ATE
TPS79730DCKT	Active	Production	SC70 (DCK) 5	250 SMALL T&R	Yes	NIPDAU NIPDAUAG	Level-1-260C-UNLIM	-40 to 85	ATE
TPS79730DCKT.A	Active	Production	SC70 (DCK) 5	250 SMALL T&R	Yes	NIPDAUAG	Level-1-260C-UNLIM	-40 to 85	ATE
TPS79733DCKR	Active	Production	SC70 (DCK) 5	3000 LARGE T&R	Yes	NIPDAU NIPDAUAG	Level-1-260C-UNLIM	-40 to 85	ATF
TPS79733DCKR.A	Active	Production	SC70 (DCK) 5	3000 LARGE T&R	Yes	NIPDAUAG	Level-1-260C-UNLIM	-40 to 85	ATF
TPS79733DCKT	Active	Production	SC70 (DCK) 5	250 SMALL T&R	Yes	NIPDAU NIPDAUAG	Level-1-260C-UNLIM	-40 to 85	ATF
TPS79733DCKT.A	Active	Production	SC70 (DCK) 5	250 SMALL T&R	Yes	NIPDAUAG	Level-1-260C-UNLIM	-40 to 85	ATF
TPS79733DCKTG4	Active	Production	SC70 (DCK) 5	250 SMALL T&R	Yes	NIPDAUAG	Level-1-260C-UNLIM	-40 to 85	ATF

(1) **Status:** For more details on status, see our [product life cycle](#).

(2) **Material type:** When designated, preproduction parts are prototypes/experimental devices, and are not yet approved or released for full production. Testing and final process, including without limitation quality assurance, reliability performance testing, and/or process qualification, may not yet be complete, and this item is subject to further changes or possible discontinuation. If available for ordering, purchases will be subject to an additional waiver at checkout, and are intended for early internal evaluation purposes only. These items are sold without warranties of any kind.

(3) **RoHS values:** Yes, No, RoHS Exempt. See the [TI RoHS Statement](#) for additional information and value definition.

(4) **Lead finish/Ball material:** Parts may have multiple material finish options. Finish options are separated by a vertical ruled line. Lead finish/Ball material values may wrap to two lines if the finish value exceeds the maximum column width.

⁽⁵⁾ **MSL rating/Peak reflow:** The moisture sensitivity level ratings and peak solder (reflow) temperatures. In the event that a part has multiple moisture sensitivity ratings, only the lowest level per JEDEC standards is shown. Refer to the shipping label for the actual reflow temperature that will be used to mount the part to the printed circuit board.

⁽⁶⁾ **Part marking:** There may be an additional marking, which relates to the logo, the lot trace code information, or the environmental category of the part.

Multiple part markings will be inside parentheses. Only one part marking contained in parentheses and separated by a "~" will appear on a part. If a line is indented then it is a continuation of the previous line and the two combined represent the entire part marking for that device.

Important Information and Disclaimer: The information provided on this page represents TI's knowledge and belief as of the date that it is provided. TI bases its knowledge and belief on information provided by third parties, and makes no representation or warranty as to the accuracy of such information. Efforts are underway to better integrate information from third parties. TI has taken and continues to take reasonable steps to provide representative and accurate information but may not have conducted destructive testing or chemical analysis on incoming materials and chemicals. TI and TI suppliers consider certain information to be proprietary, and thus CAS numbers and other limited information may not be available for release.

In no event shall TI's liability arising out of such information exceed the total purchase price of the TI part(s) at issue in this document sold by TI to Customer on an annual basis.

OTHER QUALIFIED VERSIONS OF TPS797 :

- Automotive : [TPS797-Q1](#)

NOTE: Qualified Version Definitions:

- Automotive - Q100 devices qualified for high-reliability automotive applications targeting zero defects

TAPE AND REEL INFORMATION

QUADRANT ASSIGNMENTS FOR PIN 1 ORIENTATION IN TAPE

*All dimensions are nominal

Device	Package Type	Package Drawing	Pins	SPQ	Reel Diameter (mm)	Reel Width W1 (mm)	A0 (mm)	B0 (mm)	K0 (mm)	P1 (mm)	W (mm)	Pin1 Quadrant
TPS79718DCKR	SC70	DCK	5	3000	178.0	9.0	2.4	2.5	1.2	4.0	8.0	Q3
TPS79718DCKT	SC70	DCK	5	250	180.0	8.4	2.41	2.41	1.2	4.0	8.0	Q3
TPS79718DCKT	SC70	DCK	5	250	178.0	9.0	2.4	2.5	1.2	4.0	8.0	Q3
TPS797285DCKR	SC70	DCK	5	3000	180.0	8.4	2.41	2.41	1.2	4.0	8.0	Q3
TPS797285DCKT	SC70	DCK	5	250	180.0	8.4	2.47	2.3	1.25	4.0	8.0	Q3
TPS79730DCKR	SC70	DCK	5	3000	178.0	9.0	2.4	2.5	1.2	4.0	8.0	Q3
TPS79730DCKT	SC70	DCK	5	250	180.0	8.4	2.41	2.41	1.2	4.0	8.0	Q3
TPS79730DCKT	SC70	DCK	5	250	178.0	9.0	2.4	2.5	1.2	4.0	8.0	Q3
TPS79733DCKR	SC70	DCK	5	3000	178.0	9.0	2.4	2.5	1.2	4.0	8.0	Q3
TPS79733DCKT	SC70	DCK	5	250	178.0	9.0	2.4	2.5	1.2	4.0	8.0	Q3

TAPE AND REEL BOX DIMENSIONS

*All dimensions are nominal

Device	Package Type	Package Drawing	Pins	SPQ	Length (mm)	Width (mm)	Height (mm)
TPS79718DCKR	SC70	DCK	5	3000	180.0	180.0	18.0
TPS79718DCKT	SC70	DCK	5	250	183.0	183.0	20.0
TPS79718DCKT	SC70	DCK	5	250	180.0	180.0	18.0
TPS797285DCKR	SC70	DCK	5	3000	183.0	183.0	20.0
TPS797285DCKT	SC70	DCK	5	250	183.0	183.0	20.0
TPS79730DCKR	SC70	DCK	5	3000	180.0	180.0	18.0
TPS79730DCKT	SC70	DCK	5	250	183.0	183.0	20.0
TPS79730DCKT	SC70	DCK	5	250	180.0	180.0	18.0
TPS79733DCKR	SC70	DCK	5	3000	180.0	180.0	18.0
TPS79733DCKT	SC70	DCK	5	250	180.0	180.0	18.0

EXAMPLE BOARD LAYOUT

DCK0005A

SOT - 1.1 max height

SMALL OUTLINE TRANSISTOR



LAND PATTERN EXAMPLE
EXPOSED METAL SHOWN
SCALE:18X



SOLDER MASK DETAILS

4214834/G 11/2024

NOTES: (continued)

- 7. Publication IPC-7351 may have alternate designs.
- 8. Solder mask tolerances between and around signal pads can vary based on board fabrication site.

EXAMPLE STENCIL DESIGN

DCK0005A

SOT - 1.1 max height

SMALL OUTLINE TRANSISTOR

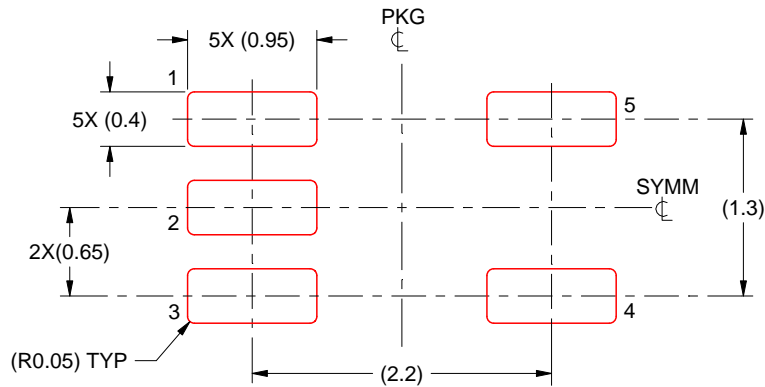

SOLDER PASTE EXAMPLE
BASED ON 0.125 THICK STENCIL
SCALE:18X

4214834/G 11/2024

NOTES: (continued)

9. Laser cutting apertures with trapezoidal walls and rounded corners may offer better paste release. IPC-7525 may have alternate design recommendations.
10. Board assembly site may have different recommendations for stencil design.

IMPORTANT NOTICE AND DISCLAIMER

TI PROVIDES TECHNICAL AND RELIABILITY DATA (INCLUDING DATA SHEETS), DESIGN RESOURCES (INCLUDING REFERENCE DESIGNS), APPLICATION OR OTHER DESIGN ADVICE, WEB TOOLS, SAFETY INFORMATION, AND OTHER RESOURCES "AS IS" AND WITH ALL FAULTS, AND DISCLAIMS ALL WARRANTIES, EXPRESS AND IMPLIED, INCLUDING WITHOUT LIMITATION ANY IMPLIED WARRANTIES OF MERCHANTABILITY, FITNESS FOR A PARTICULAR PURPOSE OR NON-INFRINGEMENT OF THIRD PARTY INTELLECTUAL PROPERTY RIGHTS.

These resources are intended for skilled developers designing with TI products. You are solely responsible for (1) selecting the appropriate TI products for your application, (2) designing, validating and testing your application, and (3) ensuring your application meets applicable standards, and any other safety, security, regulatory or other requirements.

These resources are subject to change without notice. TI grants you permission to use these resources only for development of an application that uses the TI products described in the resource. Other reproduction and display of these resources is prohibited. No license is granted to any other TI intellectual property right or to any third party intellectual property right. TI disclaims responsibility for, and you will fully indemnify TI and its representatives against, any claims, damages, costs, losses, and liabilities arising out of your use of these resources.

TI's products are provided subject to [TI's Terms of Sale](#) or other applicable terms available either on [ti.com](https://www.ti.com) or provided in conjunction with such TI products. TI's provision of these resources does not expand or otherwise alter TI's applicable warranties or warranty disclaimers for TI products.

TI objects to and rejects any additional or different terms you may have proposed.

Mailing Address: Texas Instruments, Post Office Box 655303, Dallas, Texas 75265

Copyright © 2025, Texas Instruments Incorporated