

# TLV755P 1A、低 $I_Q$ 、小型、低ドロップアウトレギュレータ

## 1 特長

- 60.3°C/W  $R_{\theta JA}$  の SOT-23-5 パッケージを利用可能
- 入力電圧範囲: 1.45V~5.5V
- 低  $I_Q$ : 25 $\mu$ A (標準値)
- 低いドロップアウト:
  - 500mA で 238mV (最大値) (3.3V<sub>OUT</sub>)
- 出力精度: 1% (85°C時の最大値)
- $V_{OUT}$  が単調増加するソフトスタートを内蔵
- フォールドバック電流制限
- アクティブ出力放電
- 高 PSRR: 100kHz 時に 46dB
- 1 $\mu$ F のセラミック出力コンデンサで安定動作
- パッケージ:
  - 2.9mm × 2.8mm SOT-23-5 (DBV)
  - 2.9mm × 2.8mm SOT-23-5 (DYD)、サーマル パッド付き
  - 1mm × 1mm X2SON-4 (DQN)
  - 2mm × 2mm WSON-6 (DRV)

## 2 アプリケーション

- セットトップ ボックス、テレビ、ゲーム機
- 携帯型およびバッテリー駆動の機器
- デスクトップ、ノート PC、ウルトラブック
- タブレットおよびリモート コントロール
- 白物家電、その他家電製品
- 電力網インフラストラクチャおよび保護リレー
- カメラ モジュールおよびイメージ センサ

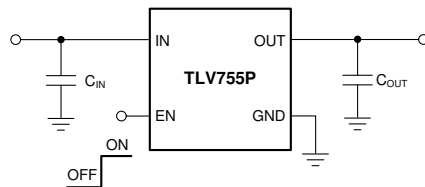

代表的なアプリケーション

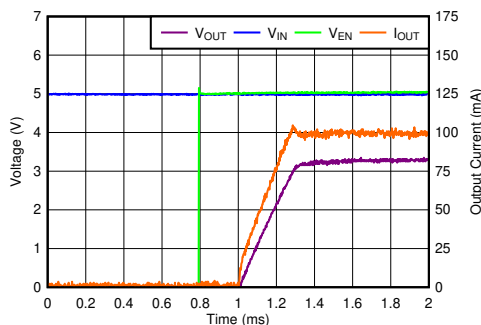

スタートアップ波形

## 3 概要

TLV755P は超小型、低静止電流の低ドロップアウトレギュレータ(LDO)で、優れたラインおよび負荷過渡特性で 500mA を供給できます。TLV755P は 1.45V~5.5V の入力電圧範囲に対応し、広範なアプリケーション用に最適化されています。コストおよびソリューション サイズを最小化するため、このデバイスは 0.6V~5V の範囲の固定出力電圧で供給され、最新のマイクロコントローラ (MCU) の低いコア電圧に対応しています。さらに、TLV755P は  $I_Q$  が低く、イネーブル機能によりスタンバイ電力を最小化できます。このデバイスには、突入電流を低減するソフトスタートが内蔵されており、負荷に対して制御された電圧を供給し、スタートアップ時の入力電圧降下を最小化します。このデバイスは、シャットダウン時に出力をアクティブにプルダウンし、出力を迅速に放電して、既知のスタートアップ状態を確保します。

TLV755P は小さなセラミック出力コンデンサで安定するため、ソリューション全体のサイズを小さくできます。高精度のバンドギャップおよびエラー アンプにより、標準的な精度は 1%です。すべてのバージョンのデバイスにはサーマル シャットダウン、電流制限、低電圧誤動作防止(UVLO)が内蔵されています。TLV755P は、短絡発生時の発熱を低減するのに役立つ内部フォールドバック電流制限機能を備えています。

TLV755 は一般的な WSON、X2SON、SOT23-5 (DRV、DQN、DBV) パッケージで供給されます。このデバイスは、標準的な SOT23-5 パッケージと比較して熱抵抗を大幅に低減できるサーマル パッド付きの熱的に強化された SOT23-5 (DYD) パッケージでも供給されます。

### パッケージ情報

部品番号	パッケージ (1)	パッケージ サイズ(2)
TLV755P	DQN (X2SON, 4)	1mm × 1mm
	DBV (SOT-23, 5)	2.9mm × 2.8mm
	DYD (SOT-23, 5)	2.9mm × 2.8mm
	DRV (WSON, 6)	2mm × 2mm

- (1) 詳細については、「[メカニカル、パッケージ、および注文情報](#)」を参照してください。
- (2) パッケージ サイズ (長さ × 幅) は公称値であり、該当する場合はピンも含まれます。



## Table of Contents

<b>1 特長</b> .....	<b>1</b>	<b>7 Application and Implementation</b> .....	<b>15</b>
<b>2 アプリケーション</b> .....	<b>1</b>	7.1 Application Information.....	15
<b>3 概要</b> .....	<b>1</b>	7.2 Typical Application.....	19
<b>4 Pin Configuration and Functions</b> .....	<b>3</b>	7.3 Power Supply Recommendations.....	21
<b>5 Specifications</b> .....	<b>4</b>	7.4 Layout.....	21
5.1 Absolute Maximum Ratings.....	4	<b>8 Device and Documentation Support</b> .....	<b>23</b>
5.2 ESD Ratings.....	4	8.1 Device Support.....	23
5.3 Recommended Operating Conditions.....	4	8.2 ドキュメントの更新通知を受け取る方法.....	23
5.4 Thermal Information .....	5	8.3 サポート・リソース.....	23
5.5 Electrical Characteristics.....	5	8.4 Trademarks.....	23
5.6 Typical Characteristics.....	7	8.5 静電気放電に関する注意事項.....	23
<b>6 Detailed Description</b> .....	<b>12</b>	8.6 用語集.....	23
6.1 Overview.....	12	<b>9 Revision History</b> .....	<b>24</b>
6.2 Functional Block Diagram.....	12	<b>10 Mechanical, Packaging, and Orderable Information</b> .....	<b>24</b>
6.3 Feature Description.....	12		
6.4 Device Functional Modes.....	14		

## 4 Pin Configuration and Functions



図 4-1. DQN Package, 4-Pin X2SON (Top View)



図 4-2. DBV Package, 5-Pin SOT-23 (Top View)

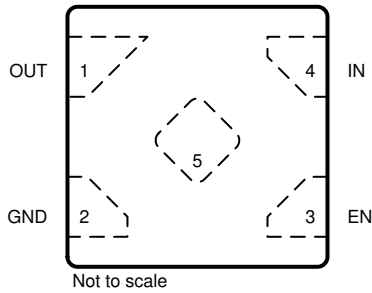

図 4-3. DYD Package, 5-Pin SOT-23 With Exposed Thermal Pad (Top View)

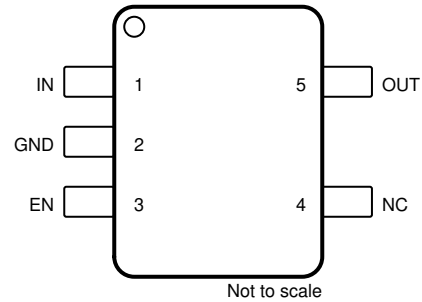

NC = no internal connection.

図 4-4. DRV Package, 6-Pin WSON With Exposed Thermal Pad (Top View)

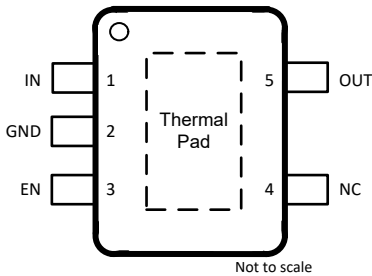
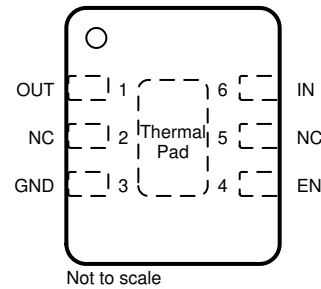
表 4-1. Pin Functions

NAME	PIN				TYPE <sup>(2)</sup>	DESCRIPTION
	DQN	DBV	DYD	DRV		
EN	3	3	3	4	I	Enable pin. Drive EN greater than $V_{HI}$ to turn on the regulator. Drive EN less than $V_{LO}$ to place the low-dropout regulator (LDO) into shutdown mode.
GND	2	2	2	3	—	Ground pin.
IN	4	1	1	6	I	Input pin. A capacitor with a value of $1\mu\text{F}$ or larger is required from this pin to ground. <sup>(1)</sup> See the <a href="#">Input and Output Capacitor Selection</a> section for more information.
NC	—	4	4	2, 5	—	No internal connection.
OUT	1	5	5	1	O	Regulated output voltage pin. A capacitor with a value of $1\mu\text{F}$ or larger is required from this pin to ground. <sup>(1)</sup> See the <a href="#">Input and Output Capacitor Selection</a> section for more information.
Thermal pad	Pad	—	Pad	Pad	—	Connect the thermal pad to a large-area ground plane. The thermal pad is internally connected to GND.

(1) Make sure the nominal input and output capacitance is greater than  $0.47\mu\text{F}$ . Throughout this document the nominal derating on these capacitors is 50%. Make sure the effective capacitance at the pin is greater than  $0.47\mu\text{F}$ .

(2) I = Input; O = Output

## 5 Specifications

### 5.1 Absolute Maximum Ratings

over operating free-air temperature range (unless otherwise noted)<sup>(1)</sup>

	MIN	MAX	UNIT
Supply voltage, $V_{IN}$	-0.3	6.0	V
Enable voltage, $V_{EN}$	-0.3	6.0	V
Output voltage, $V_{OUT}$	-0.3	$V_{IN} + 0.3$ <sup>(2)</sup>	V
Operating junction temperature $T_J$	-40	150	°C
Storage temperature, $T_{slg}$	-65	150	°C

- (1) Operation outside the *Absolute Maximum Ratings* may cause permanent device damage. *Absolute Maximum Ratings* do not imply functional operation of the device at these or any other conditions beyond those listed under *Recommended Operating Conditions*. If used outside the *Recommended Operating Conditions* but within the *Absolute Maximum Ratings*, the device may not be fully functional, and this may affect device reliability, functionality, performance, and shorten the device lifetime.
- (2) The absolute maximum rating is  $V_{IN} + 0.3$  V or 6.0 V, whichever is smaller.

### 5.2 ESD Ratings

			VALUE	UNIT
$V_{(ESD)}$	Electrostatic discharge	Human-body model (HBM), per ANSI/ESDA/JEDEC JS-001 <sup>(1)</sup>	±1000	V
		Charged-device model (CDM), per JEDEC specification JESD22-C101 <sup>(2)</sup>	±500	

- (1) JEDEC document JEP155 states that 500V HBM allows safe manufacturing with a standard ESD control process. Manufacturing with less than 500V HBM is possible with the necessary precautions.
- (2) JEDEC document JEP157 states that 250V CDM allows safe manufacturing with a standard ESD control process. Manufacturing with less than 250V CDM is possible with the necessary precautions.

### 5.3 Recommended Operating Conditions

over operating free-air temperature range (unless otherwise noted)

		MIN	NOM	MAX	UNIT
$V_{IN}$	Input voltage	1.45		5.5	V
$V_{OUT}$	Output voltage	0.6		5.0	V
$V_{EN}$	Enable voltage	0		5.5	V
$I_{OUT}$	Output current	0		500	mA
$C_{IN}$	Input capacitor	1			μF
$C_{OUT}$	Output capacitor	1		200	μF
$f_{EN}$	Enable toggle frequency			10	kHz
$T_J$	Junction temperature	-40		125	°C

## 5.4 Thermal Information

PCB	THERMAL METRIC <sup>(1) (2)</sup>		TLV755				UNIT
			DYD (SOT-23-5)	DQN (X2SON)	DBV (SOT-23-5)	DRV (WSON)	
			5 PINS	4 PINS	5 PINS	6 PINS	
EVM	R <sub>θJA</sub>	Junction-to-ambient thermal resistance	60.3	N/A	100.8	N/A	°C/W
	Ψ <sub>JT</sub>	Junction-to-top characterization parameter	14.2	N/A	23.3	N/A	
	Ψ <sub>JB</sub>	Junction-to-board characterization parameter	35.9	N/A	67.8	N/A	
JEDEC	R <sub>θJA</sub>	Junction-to-ambient thermal resistance	92.5	168.4	231.1	100.2	°C/W
	R <sub>θJC(top)</sub>	Junction-to-case (top) thermal resistance	119.8	139.1	118.4	108.5	
	R <sub>θJB</sub>	Junction-to-board thermal resistance	45.8	101.4	64.4	64.3	
	Ψ <sub>JT</sub>	Junction-to-top characterization parameter	16.7	5.6	28.4	10.4	
	Ψ <sub>JB</sub>	Junction-to-board characterization parameter	44.9	101.7	63.8	64.8	
	R <sub>θJC(bot)</sub>	Junction-to-case (bottom) thermal resistance	34.3	88.4	N/A	34.7	

- For more information about traditional and new thermal metrics, see the [Semiconductor and IC Package Thermal Metrics](#) application note.
- JEDEC thermal metrics apply to JEDEC standard PCB (2s2p, no vias to internal plane and bottom layer). EVM metrics apply to the LP087A EVM with an exposed pad SOT-23-5 (DYD) layout.

## 5.5 Electrical Characteristics

at operating temperature range ( $T_J = -40^{\circ}\text{C}$  to  $125^{\circ}\text{C}$ ),  $V_{IN} = V_{OUT(NOM)} + 0.5\text{V}$  or  $2.0\text{V}$  (whichever is greater),  $I_{OUT} = 1\text{mA}$ ,  $V_{EN} = V_{IN}$ , and  $C_{IN} = C_{OUT} = 1\mu\text{F}$  (unless otherwise noted); all typical values at  $T_J = 25^{\circ}\text{C}$

PARAMETER		TEST CONDITIONS	MIN	TYP	MAX	UNIT
V <sub>IN</sub>	Input voltage		1.45		5.5	V
V <sub>OUT</sub>	Output voltage		0.6		5.0	V
	Output accuracy	$-40^{\circ}\text{C} \leq T_J \leq +85^{\circ}\text{C}$ , DBV and DRV package	-1		1	%
		$V_{OUT} \geq 1.0\text{V}$ , DQN package	-1.2		1.2	%
		$-40^{\circ}\text{C} \leq T_J \leq +85^{\circ}\text{C}$ ; $0.6\text{V} \leq V_{OUT} < 1.0\text{V}$	-10		10	mV
		$V_{OUT} \geq 1\text{V}$	-1.5		1.5	%
		$0.6\text{V} \leq V_{OUT} < 1\text{V}$	-15		15	mV
(ΔV <sub>OUT</sub> )/ΔV <sub>IN</sub>	Line regulation	$V_{OUT} + 0.5\text{V} \leq V_{IN} \leq 5.5\text{V}$ , $V_{OUT} > 1.5\text{V}$		2		mV
ΔV <sub>OUT</sub> /ΔI <sub>OUT</sub>	Load regulation	0.1mA ≤ I <sub>OUT</sub> ≤ 500mA				V/A
		DQN package		0.036		
		DBV and DYD packages		0.060		
		DRV package		0.044		
I <sub>GND</sub>	Ground current	T <sub>J</sub> = 25°C, I <sub>OUT</sub> = 0mA	14	25	31	μA
		$-40^{\circ}\text{C} \leq T_J \leq +85^{\circ}\text{C}$ , I <sub>OUT</sub> = 0mA			33	
		$-40^{\circ}\text{C} \leq T_J \leq +125^{\circ}\text{C}$ , I <sub>OUT</sub> = 0mA			40	
I <sub>SHDN</sub>	Shutdown current	$V_{EN} \leq 0.4\text{V}$ , $1.4\text{V} \leq V_{IN} \leq 5.5\text{V}$ , $-40^{\circ}\text{C} \leq T_J \leq +125^{\circ}\text{C}$		0.1	1	μA
I <sub>CL</sub>	Output current limit	V <sub>IN</sub> = V <sub>OUT</sub> + V <sub>DO(MAX)</sub> + 0.25V				mA
		V <sub>OUT</sub> = V <sub>OUT</sub> - 0.2V, V <sub>OUT</sub> ≤ 1.5V	560	720	865	
		V <sub>OUT</sub> = 0.9 × V <sub>OUT</sub> , 1.5V < V <sub>OUT</sub> ≤ 4.5V	560	720	865	
I <sub>SC</sub>	Short-circuit current limit	V <sub>OUT</sub> = 0V		355		mA

## 5.5 Electrical Characteristics (続き)

at operating temperature range ( $T_J = -40^\circ\text{C}$  to  $125^\circ\text{C}$ ),  $V_{IN} = V_{OUT(NOM)} + 0.5\text{V}$  or  $2.0\text{V}$  (whichever is greater),  $I_{OUT} = 1\text{mA}$ ,  $V_{EN} = V_{IN}$ , and  $C_{IN} = C_{OUT} = 1\mu\text{F}$  (unless otherwise noted); all typical values at  $T_J = 25^\circ\text{C}$

PARAMETER	TEST CONDITIONS	MIN	TYP	MAX	UNIT		
$V_{DO}$	Dropout voltage	$I_{OUT} = 500\text{mA}$ , $-40^\circ\text{C} \leq T_J \leq +85^\circ\text{C}$	$0.6\text{V} \leq V_{OUT} < 0.8\text{V}$	675	1080	mV	
			$0.8\text{V} \leq V_{OUT} < 1.0\text{V}$	600	930		
			$0.8\text{V} \leq V_{OUT} < 1.0\text{V}$ , DYD package	600	950		
			$1.0\text{V} \leq V_{OUT} < 1.2\text{V}$	550	780		
			$1.0\text{V} \leq V_{OUT} < 1.2\text{V}$ , DYD package	550	800		
			$1.2\text{V} \leq V_{OUT} < 1.5\text{V}$	500	630		
			$1.2\text{V} \leq V_{OUT} < 1.5\text{V}$ , DYD package	500	650		
			$1.5\text{V} \leq V_{OUT} < 1.8\text{V}$	350	400		
			$1.5\text{V} \leq V_{OUT} < 1.8\text{V}$ , DYD package	350	420		
			$1.8\text{V} \leq V_{OUT} < 2.5\text{V}$	325	380		
			$1.8\text{V} \leq V_{OUT} < 2.5\text{V}$ , DYD package	325	400		
			$2.5\text{V} \leq V_{OUT} < 3.3\text{V}$	250	300		
		$2.5\text{V} \leq V_{OUT} < 3.3\text{V}$ , DYD package	250	320			
		$3.3\text{V} \leq V_{OUT} < 5.0\text{V}$	150	215			
		$3.3\text{V} \leq V_{OUT} < 5.0\text{V}$ , DYD package	150	238			
		$I_{OUT} = 500\text{mA}$ , $-40^\circ\text{C} \leq T_J \leq +125^\circ\text{C}$	$0.6\text{V} \leq V_{OUT} < 0.8\text{V}$				1140
			$0.8\text{V} \leq V_{OUT} < 1.0\text{V}$				985
			$0.8\text{V} \leq V_{OUT} < 1.0\text{V}$ , DYD package				1005
			$1.0\text{V} \leq V_{OUT} < 1.2\text{V}$				825
			$1.0\text{V} \leq V_{OUT} < 1.2\text{V}$ , DYD package				845
			$1.2\text{V} \leq V_{OUT} < 1.5\text{V}$				665
			$1.2\text{V} \leq V_{OUT} < 1.5\text{V}$ , DYD package				685
			$1.5\text{V} \leq V_{OUT} < 1.8\text{V}$				425
			$1.5\text{V} \leq V_{OUT} < 1.8\text{V}$ , DYD package				445
$1.8\text{V} \leq V_{OUT} < 2.5\text{V}$				400			
$1.8\text{V} \leq V_{OUT} < 2.5\text{V}$ , DYD package				420			
$2.5\text{V} \leq V_{OUT} < 3.3\text{V}$				325			
$2.5\text{V} \leq V_{OUT} < 3.3\text{V}$ , DYD package			345				
$3.3\text{V} \leq V_{OUT} < 5.0\text{V}$			238				
$3.3\text{V} \leq V_{OUT} < 5.0\text{V}$ , DYD package			258				
PSRR	Power-supply rejection ratio	$f = 1\text{kHz}$ , $V_{IN} = V_{OUT} + 1\text{V}$ , $I_{OUT} = 50\text{mA}$		52	dB		
		$f = 100\text{kHz}$ , $V_{IN} = V_{OUT} + 1\text{V}$ , $I_{OUT} = 50\text{mA}$		46			
		$f = 1\text{MHz}$ , $V_{IN} = V_{OUT} + 1\text{V}$ , $I_{OUT} = 50\text{mA}$		52			
$V_N$	Output noise voltage	$\text{BW} = 10\text{Hz to } 100\text{kHz}$ ; $V_{OUT} = 1.2\text{V}$ , $I_{OUT} = 50\text{mA}$		71.5	$\mu\text{V}_{\text{RMS}}$		
$V_{UVLO}$	Undervoltage lockout	$V_{IN}$ rising	1.21	1.3	1.44	V	
$V_{UVLO,HYST}$	Undervoltage lockout hysteresis	$V_{IN}$ falling		40		mV	
$t_{STR}$	Startup time			550		$\mu\text{s}$	
$V_{HI}$	EN pin high voltage (enabled)		1			V	
$V_{LO}$	EN pin low voltage (enabled)				0.3	V	
$I_{EN}$	Enable pin current	$V_{IN} = 5.5\text{V}$		10		nA	
$T_{SD}$	Thermal shutdown	Shutdown, temperature increasing		165		$^\circ\text{C}$	
		Reset, temperature decreasing		155			
$R_{PULLDOWN}$	Pulldown resistance	$V_{IN} = 5.5\text{V}$		120		$\Omega$	

## 5.6 Typical Characteristics

at operating temperature  $T_J = 25^\circ\text{C}$ ,  $V_{IN} = V_{OUT(NOM)} + 0.5\text{V}$  or  $1.45\text{V}$  (whichever is greater),  $I_{OUT} = 1\text{mA}$ ,  $V_{EN} = V_{IN}$ , and  $C_{IN} = C_{OUT} = 1\mu\text{F}$  (unless otherwise noted)

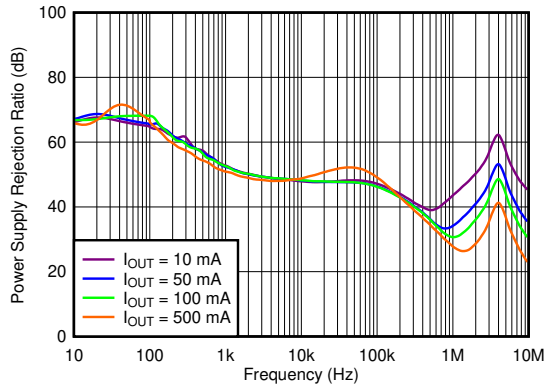

$V_{IN} = 4.3\text{V}$ ,  $V_{OUT} = 3.3\text{V}$ ,  $C_{OUT} = 1\mu\text{F}$   
**5-1. PSRR vs Frequency and  $I_{OUT}$**

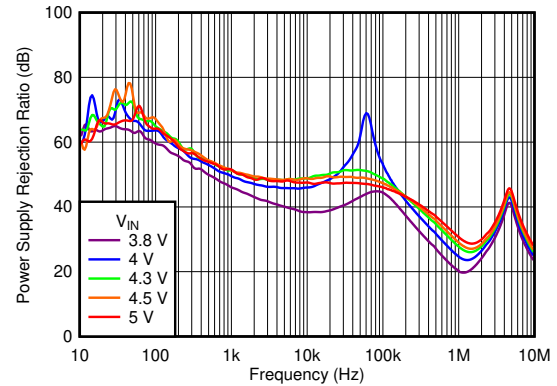

$V_{OUT} = 3.3\text{V}$ ,  $C_{OUT} = 1\mu\text{F}$ ,  $I_{OUT} = 500\text{mA}$   
**5-2. PSRR vs Frequency and  $V_{IN}$**

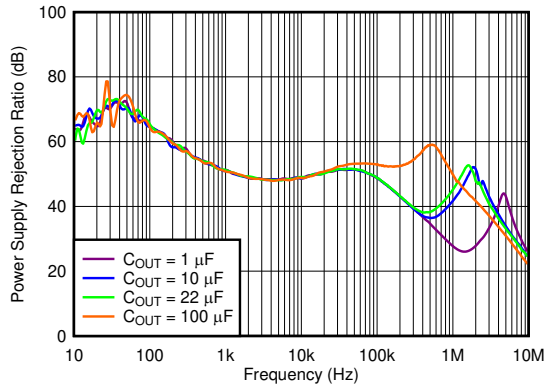

$V_{IN} = 4.3\text{V}$ ,  $V_{OUT} = 3.3\text{V}$ ,  $I_{OUT} = 500\text{mA}$   
**5-3. PSRR vs Frequency and  $C_{OUT}$**

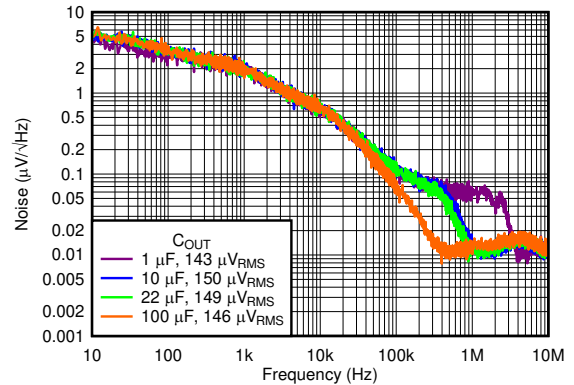

$V_{OUT} = 3.3\text{V}$ ,  $V_{RMS}$  BW = 10Hz to 100kHz  
**5-4. Output Spectral Noise Density vs Frequency and  $C_{OUT}$**

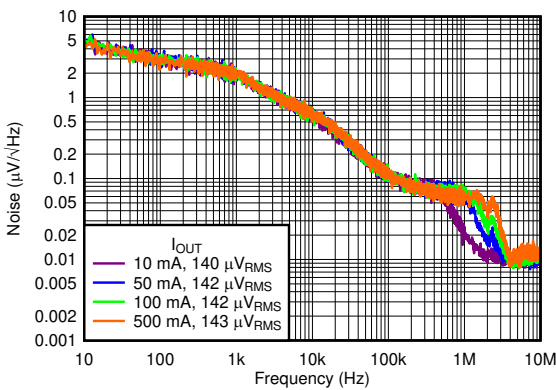

$V_{OUT} = 3.3\text{V}$ ,  $I_{OUT} = 500\text{mA}$ ,  $C_{OUT} = 1\mu\text{F}$ ,  $V_{RMS}$  BW = 10Hz to 100kHz  
**5-5. Output Spectral Noise Density vs Frequency and  $I_{OUT}$**

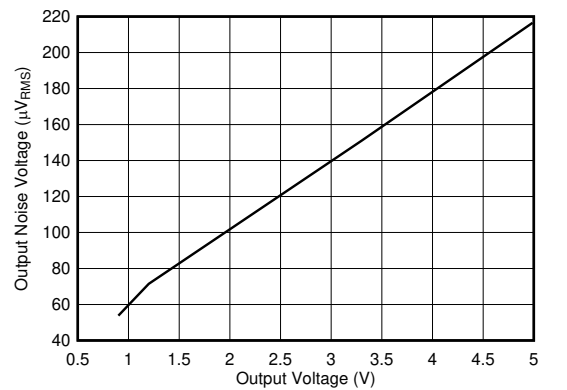

$I_{OUT} = 500\text{mA}$ ,  $C_{OUT} = 1\mu\text{F}$ ,  $V_{RMS}$  BW = 10Hz to 100kHz  
**5-6. Output Noise Voltage vs  $V_{OUT}$**

### 5.6 Typical Characteristics (continued)

at operating temperature  $T_J = 25^\circ\text{C}$ ,  $V_{IN} = V_{OUT(NOM)} + 0.5\text{V}$  or  $1.45\text{V}$  (whichever is greater),  $I_{OUT} = 1\text{mA}$ ,  $V_{EN} = V_{IN}$ , and  $C_{IN} = C_{OUT} = 1\mu\text{F}$  (unless otherwise noted)

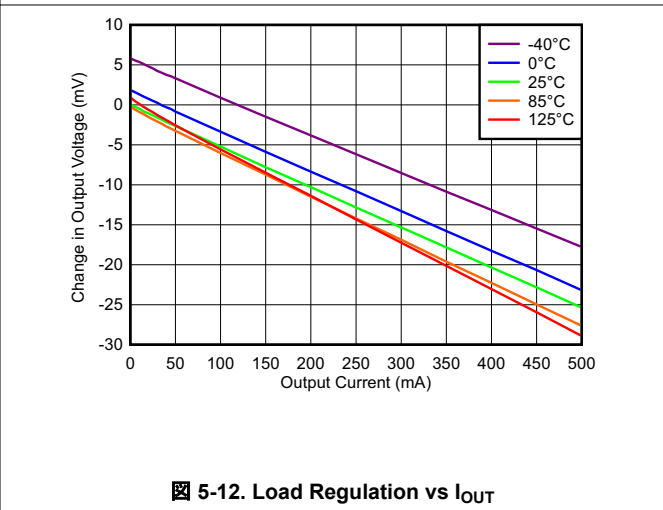
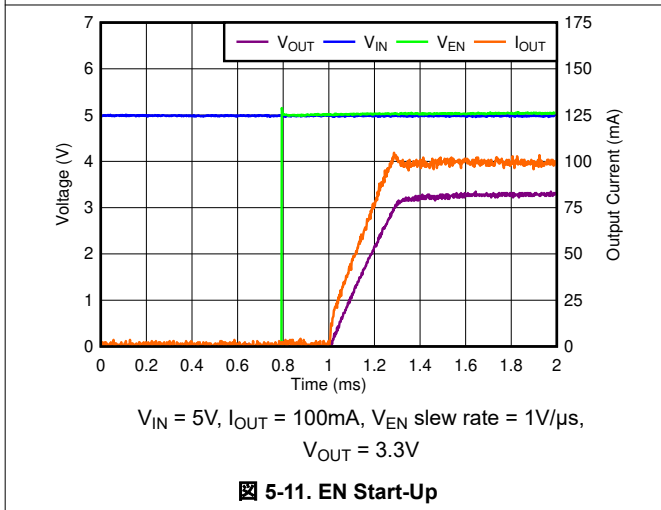
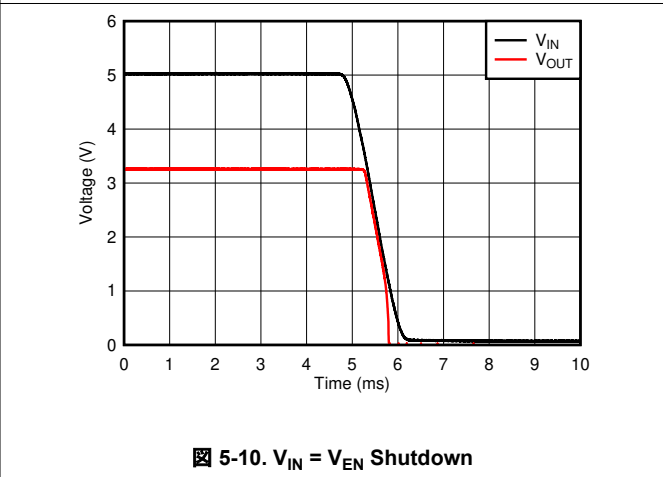
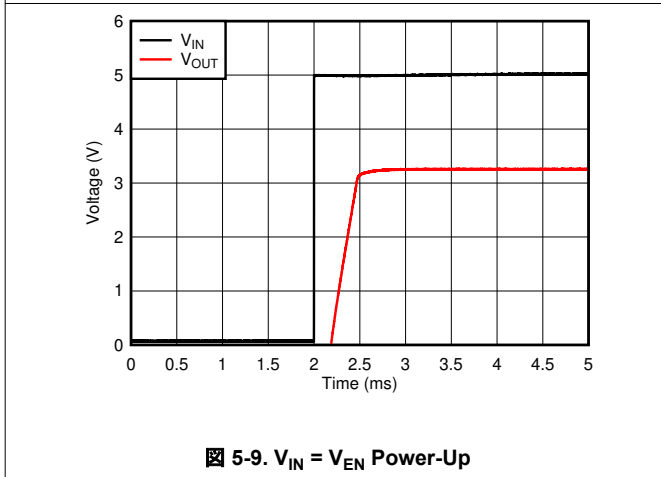
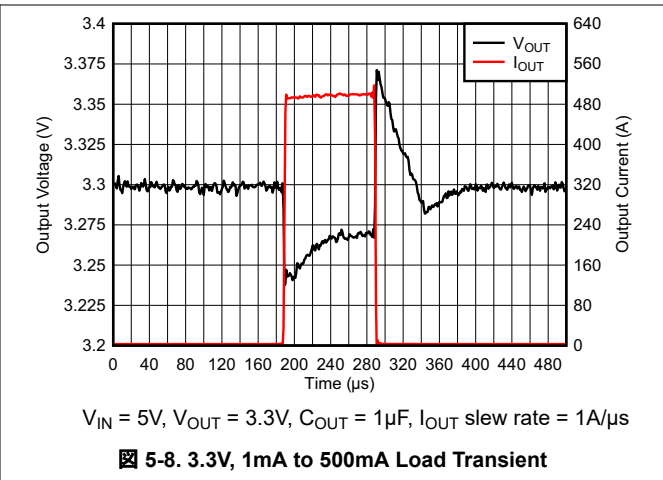
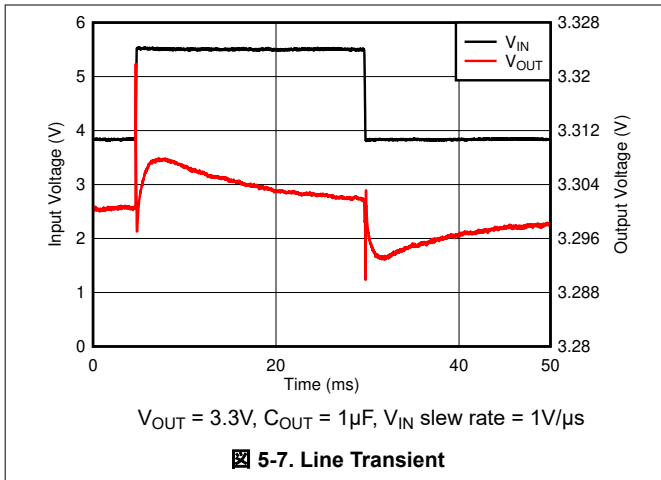



## 5.6 Typical Characteristics (continued)

at operating temperature  $T_J = 25^\circ\text{C}$ ,  $V_{IN} = V_{OUT(NOM)} + 0.5\text{V}$  or  $1.45\text{V}$  (whichever is greater),  $I_{OUT} = 1\text{mA}$ ,  $V_{EN} = V_{IN}$ , and  $C_{IN} = C_{OUT} = 1\mu\text{F}$  (unless otherwise noted)



图 5-13. 3.3V Dropout Voltage vs  $I_{OUT}$



图 5-14. 5.0V Dropout Voltage vs  $I_{OUT}$

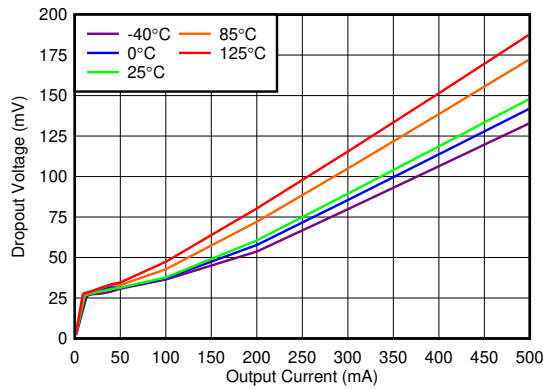

图 5-15. 3.3V Regulation vs  $V_{IN}$  (Line Regulation)

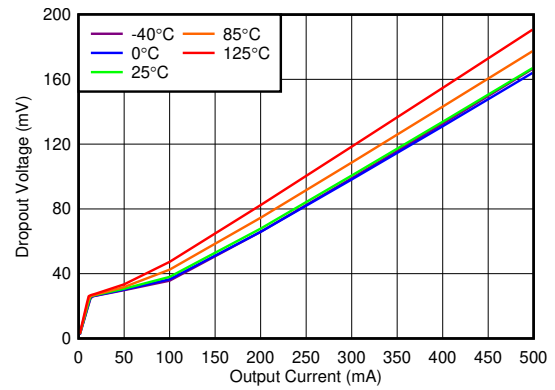

图 5-16. 5.0V Accuracy vs  $V_{IN}$  (Line Regulation)

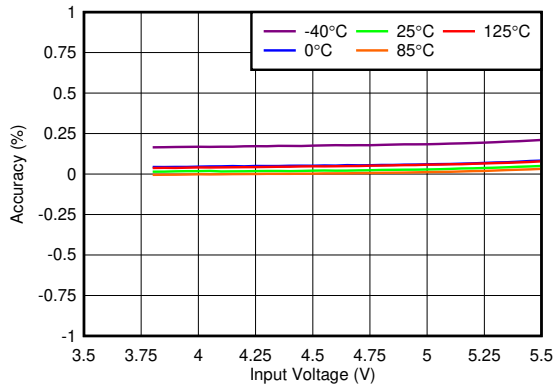

图 5-17.  $I_{GND}$  vs  $I_{OUT}$

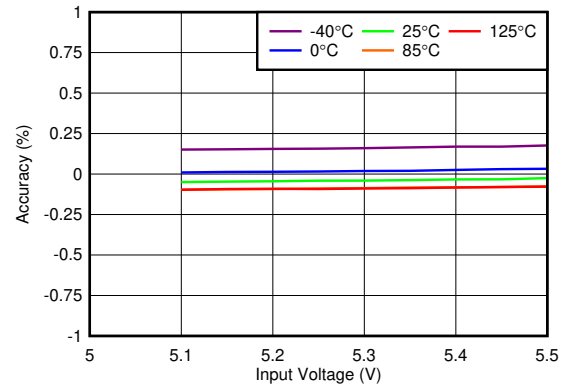

图 5-18.  $I_{GND}$  vs  $V_{IN}$

### 5.6 Typical Characteristics (continued)

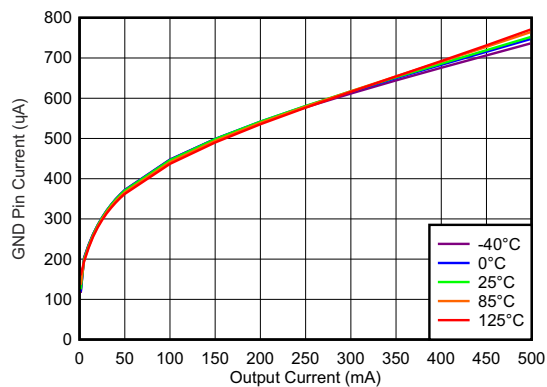
at operating temperature  $T_J = 25^\circ\text{C}$ ,  $V_{IN} = V_{OUT(\text{NOM})} + 0.5\text{V}$  or  $1.45\text{V}$  (whichever is greater),  $I_{OUT} = 1\text{mA}$ ,  $V_{EN} = V_{IN}$ , and  $C_{IN} = C_{OUT} = 1\mu\text{F}$  (unless otherwise noted)

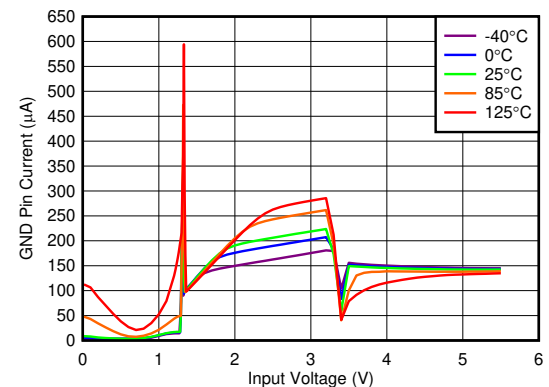
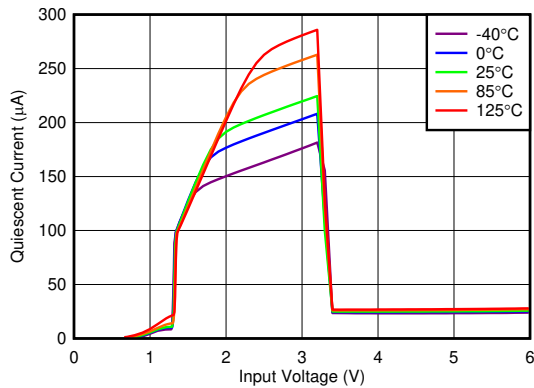

$V_{OUT} = 3.3\text{V}$ ,  $I_{OUT} = 0\text{mA}$

图 5-19.  $I_Q$  vs  $V_{IN}$

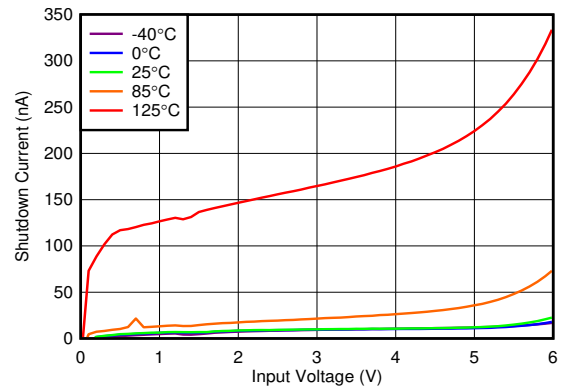

$V_{EN} = 0\text{V}$

图 5-20.  $I_{SHDN}$  vs  $V_{IN}$

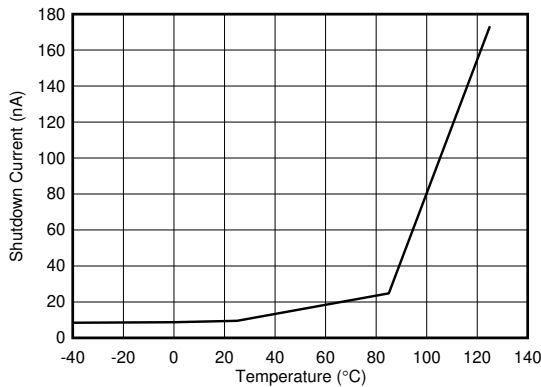

$V_{EN} = 0\text{V}$

图 5-21.  $I_{SHDN}$  vs Temperature



图 5-22. Enable Threshold vs Temperature



$V_{EN} = 5.5\text{V}$

图 5-23.  $I_{EN}$  vs  $V_{IN}$

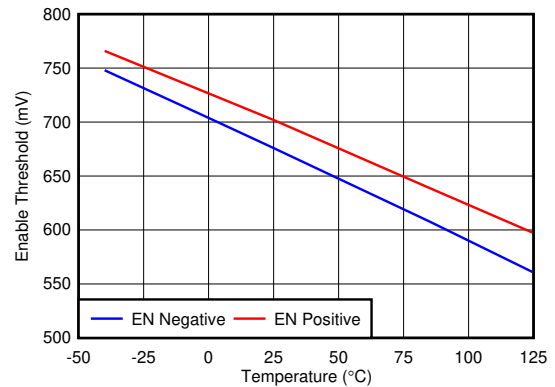
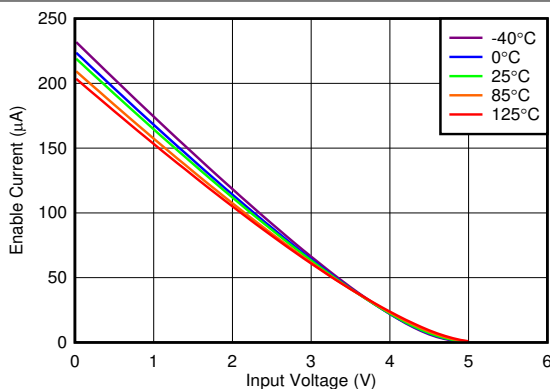

图 5-24. UVLO Threshold vs Temperature

### 5.6 Typical Characteristics (continued)

at operating temperature  $T_J = 25^\circ\text{C}$ ,  $V_{IN} = V_{OUT(NOM)} + 0.5\text{V}$  or  $1.45\text{V}$  (whichever is greater),  $I_{OUT} = 1\text{mA}$ ,  $V_{EN} = V_{IN}$ , and  $C_{IN} = C_{OUT} = 1\mu\text{F}$  (unless otherwise noted)

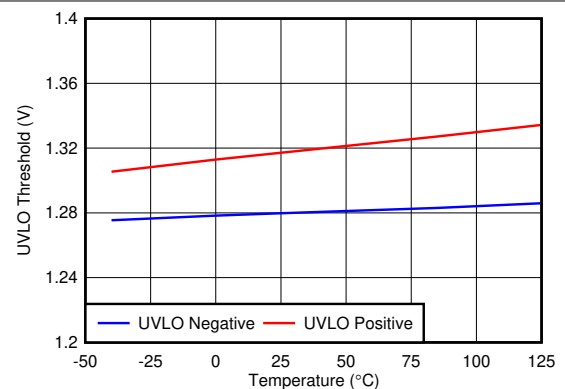
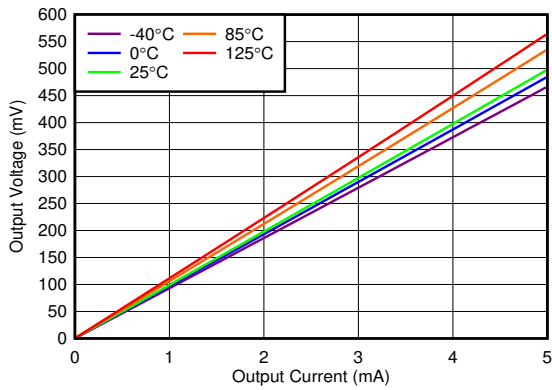

5-25.  $V_{OUT}$  vs  $I_{OUT}$  Pulldown Resistor

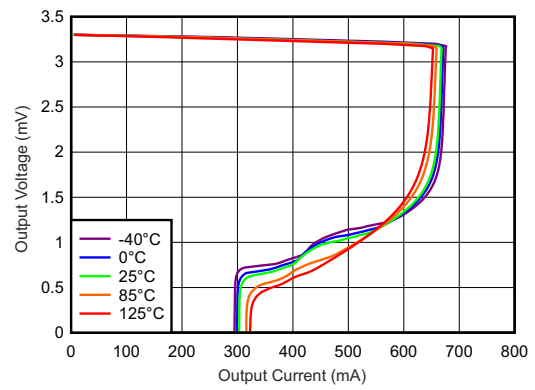

5-26. 3.3V Foldback Current Limit,  $V_{OUT}$  vs  $I_{OUT}$

## 6 Detailed Description

### 6.1 Overview

The TLV755P low-dropout regulator (LDO) consumes low quiescent current and delivers excellent line and load transient performance. The TLV755P is optimized for a wide variety of applications by supporting an input voltage range from 1.45V to 5.5V. To minimize cost and solution size, the device is offered in fixed output voltages ranging from 0.6V to 5V to support the lower core voltages of modern microcontrollers (MCUs).

This regulator offers foldback current limit, shutdown, and thermal protection. The operating junction temperature is  $-40^{\circ}\text{C}$  to  $+125^{\circ}\text{C}$ .

### 6.2 Functional Block Diagram

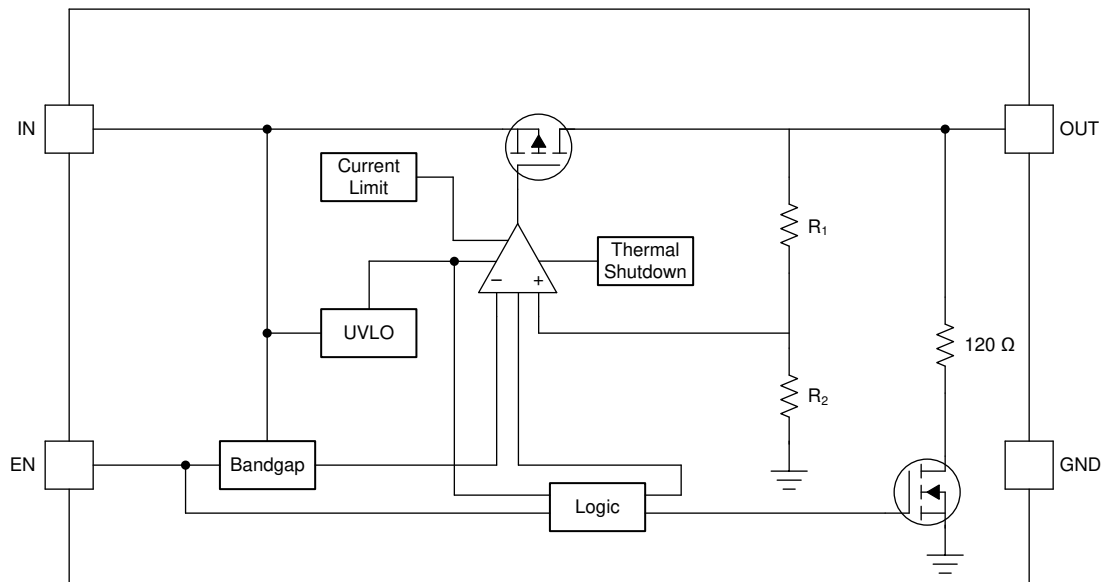

$R_2 = 550\text{k}\Omega$ ,  $R_1 = \text{adjustable}$ .

### 6.3 Feature Description

#### 6.3.1 Undervoltage Lockout (UVLO)

An undervoltage lockout (UVLO) circuit disables the output until the input voltage is greater than the rising UVLO voltage ( $V_{UVLO}$ ). This circuit makes sure the device does not exhibit unpredictable behavior when the supply voltage is lower than the operational range of the internal circuitry. When  $V_{IN}$  is less than  $V_{UVLO}$ , the output is connected to ground with a  $120\Omega$  pulldown resistor.

#### 6.3.2 Enable (EN)

The enable pin (EN) is active high. Enable the device by forcing the EN pin to exceed  $V_{HI}$ . Turn off the device by forcing the EN pin below  $V_{LO}$ . If shutdown capability is not required, connect EN to IN.

The device has an internal pulldown that connects a  $120\Omega$  resistor to ground when the device is disabled. The discharge time after disabling depends on the output capacitance ( $C_{OUT}$ ) and the load resistance ( $R_L$ ) in parallel with the  $120\Omega$  pulldown resistor. 式 1 calculates the time constant  $\tau$ :

$$\tau = \frac{120 \cdot R_L}{120 + R_L} \cdot C_{OUT} \quad (1)$$

The EN pin is independent of the input pin (IN), but if the EN pin is driven to a higher voltage than  $V_{IN}$ , the current into the EN pin increases. This effect is illustrated in [Figure 5-23](#). When the EN voltage is higher than the input voltage there is an increased current flow into the EN pin. If this increased flow causes problems in the application, sequence the EN pin after  $V_{IN}$  is high, or to tie EN to  $V_{IN}$  to prevent this flow increase from happening. If EN is driven to a higher voltage than  $V_{IN}$ , limit the frequency on EN to below 10kHz.

### 6.3.3 Internal Foldback Current Limit

The TLV755P has an internal current limit that protects the regulator during fault conditions. The current limit is a hybrid scheme with brick wall until the output voltage is less than  $0.4V \times V_{OUT(NOM)}$ . When the voltage drops below  $0.4V \times V_{OUT(NOM)}$ , a foldback current limit is implemented that scales back the current as the output voltage approaches GND. When the output shorts, the LDO supplies a typical current of  $I_{SC}$ . The output voltage is not regulated when the device is in current limit. In this condition, the output voltage is the product of the regulated current and the load resistance. When the device output shorts, the PMOS pass transistor dissipates power  $[(V_{IN} - V_{OUT}) \times I_{SC}]$  until thermal shutdown is triggered and the device turns off. After the device cools down, the internal thermal shutdown circuit turns the device back on. If the fault condition continues, the device cycles between current limit and thermal shutdown.

The foldback current-limit circuit limits the current that is allowed through the device to current levels lower than the minimum current limit at nominal  $V_{OUT}$  current limit ( $I_{CL}$ ) during start-up. See [Figure 5-26](#) for typical current limit values. If the output is loaded by a constant-current load during start-up, or if the output voltage is negative when the device is enabled, then the load current demanded by the load potentially exceeds the foldback current limit and the device does not rise to the full output voltage. For constant-current loads, disable the output load until the output rises to the nominal voltage.

Excess inductance causes the current limit to oscillate. Minimize the inductance to keep the current limit from oscillating during a fault condition.

### 6.3.4 Thermal Shutdown

Thermal shutdown protection disables the output when the junction temperature rises to approximately 165°C. Disabling the device eliminates the power dissipated by the device, allowing the device to cool. When the junction temperature cools to approximately 155°C, the output circuitry is enabled again. Depending on power dissipation, thermal resistance, and ambient temperature, the thermal protection circuit cycles on and off. This cycling limits regulator dissipation that protects the circuit from damage as a result of overheating.

Activating the thermal shutdown feature typically indicates excessive power dissipation as a result of the product of the  $(V_{IN} - V_{OUT})$  voltage and the load current. For reliable operation, limit junction temperature to a maximum of 125°C. To estimate the margin of safety in a complete design, increase the ambient temperature until the thermal protection is triggered; use worst-case loads and signal conditions.

The internal protection circuitry protects against overload conditions but is not intended to be activated in normal operation. Continuously running the device into thermal shutdown degrades device reliability.

## 6.4 Device Functional Modes

表 6-1 lists a comparison between the normal, dropout, and disabled modes of operation.

**表 6-1. Device Functional Modes Comparison**

OPERATING MODE	PARAMETER			
	$V_{IN}$	EN	$I_{OUT}$	$T_J$
Normal <sup>(1)</sup>	$V_{IN} > V_{OUT(NOM)} + V_{DO}$	$V_{EN} > V_{HI}$	$I_{OUT} < I_{CL}$	$T_J < T_{SD}$
Dropout <sup>(1)</sup>	$V_{IN} < V_{OUT(NOM)} + V_{DO}$	$V_{EN} > V_{HI}$	—	$T_J < T_{SD}$
Disabled <sup>(2)</sup>	$V_{IN} < V_{UVLO}$	$V_{EN} < V_{LO}$	—	$T_J > T_{SD}$

(1) Make sure all table conditions are met.

(2) The device is disabled when any condition is met.

### 6.4.1 Normal Operation

The device regulates to the nominal output voltage when all of the following conditions are met.

- The input voltage is greater than the nominal output voltage plus the dropout voltage ( $V_{OUT(NOM)} + V_{DO}$ )
- The enable voltage has previously exceeded the enable rising threshold voltage and has not decreased below the enable falling threshold
- The output current is less than the current limit ( $I_{OUT} < I_{CL}$ )
- The device junction temperature is less than the thermal shutdown temperature ( $T_J < T_{SD}$ )

### 6.4.2 Dropout Operation

If the input voltage is lower than the nominal output voltage plus the specified dropout voltage, but all other conditions are met for normal operation, the device operates in dropout. In this mode, the output voltage tracks the input voltage. During this mode, the transient performance of the device degrades because the pass transistor is in a triode state and no longer controls the output voltage of the LDO. Line or load transients in dropout result in large output voltage deviations.

When the device is in a steady dropout state (defined as when the device is in dropout,  $V_{IN} < V_{OUT(NOM)} + V_{DO}$ , right after being in a normal regulation state, but not during start-up), the pass transistor is driven as hard as possible when the control loop is out of balance. During the normal time required for the device to regain regulation,  $V_{IN} \geq V_{OUT(NOM)} + V_{DO}$ ,  $V_{OUT}$  overshoots  $V_{OUT(NOM)}$  during fast transients.

### 6.4.3 Disabled

The output is shut down by forcing the enable pin below  $V_{LO}$ . When disabled, the pass transistor is turned off, internal circuits are shut down, and the output voltage is actively discharged to ground by an internal switch from the output to ground. The active pulldown is on when sufficient input voltage is provided.

## 7 Application and Implementation

### 注

以下のアプリケーション情報は、TI の製品仕様に含まれるものではなく、TI ではその正確性または完全性を保証いたしません。個々の目的に対する製品の適合性については、お客様の責任で判断していただくこととなります。お客様は自身の設計実装を検証しテストすることで、システムの機能を確認する必要があります。

### 7.1 Application Information

#### 7.1.1 Input and Output Capacitor Selection

The TLV755P requires an output capacitance of 0.47 $\mu$ F or larger for stability. Use X5R- and X7R-type ceramic capacitors because these capacitors have minimal variation in capacitance value and equivalent series resistance (ESR) over temperature. When selecting a capacitor for a specific application, consider the DC bias characteristics for the capacitor. Higher output voltages cause a significant derating of the capacitor. Generally, derate ceramic capacitors by 50%. For best performance, use a maximum output capacitance value of 200 $\mu$ F.

Place a 1 $\mu$ F or greater capacitor on the input pin of the LDO. Some input supplies have a high impedance. Placing a capacitor on the input supply reduces the input impedance. The input capacitor counteracts reactive input sources and improves transient response and PSRR. If the input supply has a high impedance over a large range of frequencies, several input capacitors are used in parallel to lower the impedance over frequency. Use a higher-value capacitor if large, fast, rise-time load transients are expected, or if the device is located several inches from the input power source.

#### 7.1.2 Dropout Voltage

The TLV755P uses a PMOS pass transistor to achieve low dropout. When ( $V_{IN} - V_{OUT}$ ) is less than the dropout voltage ( $V_{DO}$ ), the PMOS pass transistor is in the linear region of operation and the input-to-output resistance is the  $R_{DS(ON)}$  of the PMOS pass transistor.  $V_{DO}$  scales linearly with the output current because the PMOS transistor functions like a resistor in dropout mode. As with any linear regulator, PSRR and transient response degrade as ( $V_{IN} - V_{OUT}$ ) approaches dropout operation. See [Figure 5-13](#) and [Figure 5-14](#) for typical dropout values.

#### 7.1.3 Exiting Dropout

Some applications have transients that place the LDO into dropout, such as slower ramps on  $V_{IN}$  during start-up. As with other LDOs, the output overshoots on recovery from these conditions. A ramping input supply causes an LDO to overshoot on start-up when the slew rate and voltage levels are in the correct range; see [Figure 7-1](#). Use an enable signal to avoid this condition.



図 7-1. Start-Up Into Dropout

Line transients out of dropout can also cause overshoot on the output of the regulator. These overshoots are caused by the error amplifier having to drive the gate capacitance of the pass transistor and bring the gate back to the correct voltage for proper regulation. 図 7-2 illustrates what is happening internally with the gate voltage and how overshoot is caused during operation. When the LDO is placed in dropout, the gate voltage (VGS) is pulled all the way down to ground to give the pass transistor the lowest on-resistance as possible. However, if a line transient occurs when the device is in dropout, the loop is not in regulation and causes the output to overshoot until the loop responds and the output current pulls the output voltage back down into regulation. If these transients are not acceptable, then continue to add input capacitance in the system until the transient is slow enough to reduce the overshoot.



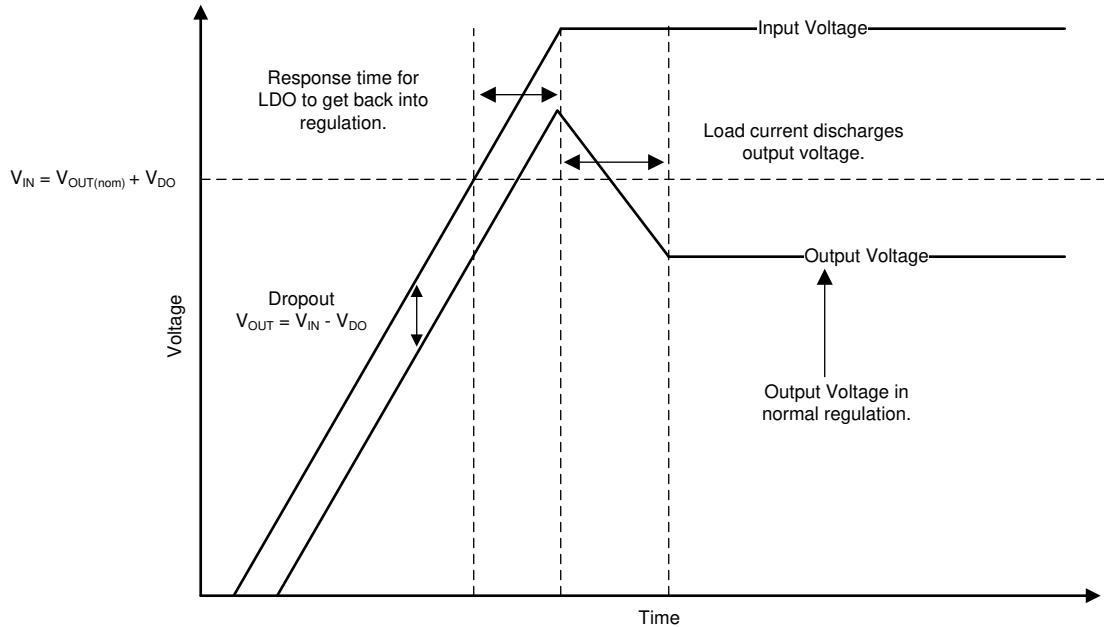
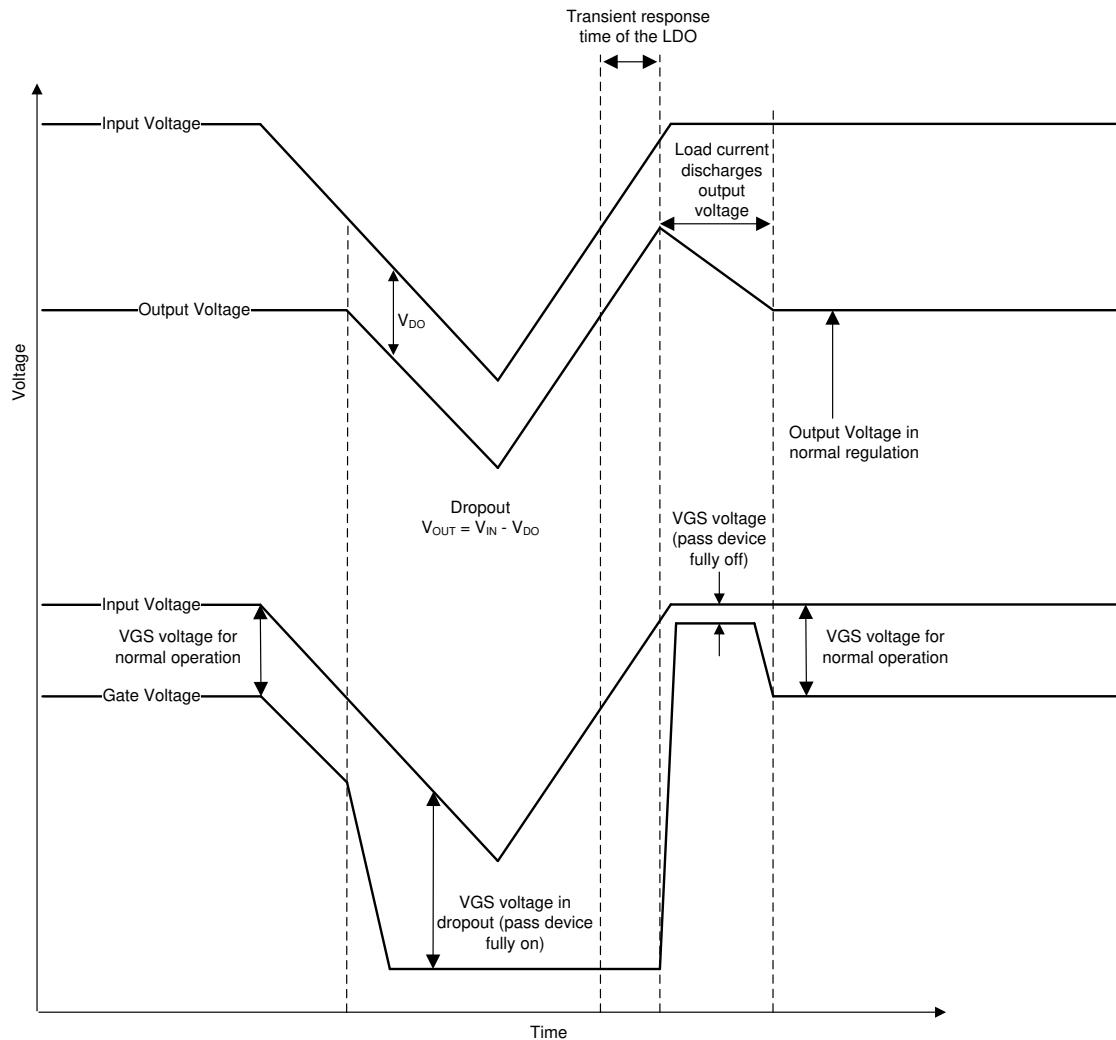

**7-2. Line Transients From Dropout**

### 7.1.4 Reverse Current

As with most LDOs, excessive reverse current potentially damages this device.

Reverse current flows through the body diode on the pass transistor instead of the normal conducting channel. At high magnitudes, this current flow degrades the long-term reliability of the device, as a result of one of the following conditions:

- Degradation caused by electromigration
- Excessive heat dissipation
- Potential for a latch-up condition

Conditions where reverse current occur are outlined in this section, all of which exceed the absolute maximum rating of  $V_{OUT} > V_{IN} + 0.3V$ :

- If the device has a large  $C_{OUT}$  and the input supply collapses with little or no load current
- The output is biased when the input supply is not established
- The output is biased above the input supply

If reverse current flow is expected in the application, use external protection to protect the device. 図 7-3 shows one approach of protecting the device.



図 7-3. Example Circuit for Reverse Current Protection Using a Schottky Diode

### 7.1.5 Power Dissipation ( $P_D$ )

Circuit reliability demands that proper consideration be given to device power dissipation, location of the circuit on the printed circuit board (PCB), and correct sizing of the thermal plane. Make sure the PCB area around the regulator is as free of other heat-generating devices as possible that cause added thermal stresses.

As a first-order approximation, power dissipation in the regulator depends on the input-to-output voltage difference and load conditions. Use 式 2 to approximate  $P_D$ :

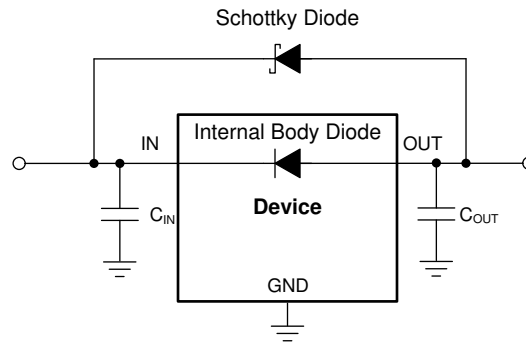
$$P_D = (V_{IN} - V_{OUT}) \times I_{OUT} \quad (2)$$

Minimize power dissipation to achieve greater efficiency. This minimizing process is achieved by selecting the correct system voltage rails. Proper selection helps obtain the minimum input-to-output voltage differential. The low dropout of the device allows for maximum efficiency across a wide range of output voltages.

The main heat-conduction path for the device is through the thermal pad on the package. As such, solder the thermal pad to a copper pad area under the device. This pad area contains an array of plated vias that conduct heat to inner plane areas or to a bottom-side copper plane.

The maximum allowable junction temperature ( $T_J$ ) determines the maximum power dissipation for the device. According to 式 3, power dissipation and junction temperature are most often related by the junction-to-ambient thermal resistance ( $R_{\theta JA}$ ) of the combined PCB, device package, and the temperature of the ambient air ( $T_A$ ).

$$T_J = T_A + R_{\theta JA} \times P_D \quad (3)$$

Unfortunately, this thermal resistance ( $R_{\theta JA}$ ) is dependent on the heat-spreading capability built into the particular PCB design, and therefore varies according to the total copper area, copper weight, and location of the planes. The  $R_{\theta JA}$  value is only used as a relative measure of package thermal performance.  $R_{\theta JA}$  is the sum of the package junction-to-case (bottom) thermal resistance ( $R_{\theta JCbot}$ ) plus the thermal resistance contribution by the PCB copper.

### 7.1.5.1 Estimating Junction Temperature

The JEDEC standard recommends the use of psi ( $\Psi$ ) thermal metrics to estimate the junction temperatures of the LDO when in-circuit on a typical PCB board application. These metrics are not thermal resistances, but offer practical and relative means of estimating junction temperatures. These psi metrics are independent of the copper-spreading area. The key thermal metrics ( $\Psi_{JT}$  and  $\Psi_{JB}$ ) are used in accordance with 式 4 and are described in the *Thermal Information* table.

$$\begin{aligned} \Psi_{JT}: T_J &= T_T + \Psi_{JT} \times P_D \\ \Psi_{JB}: T_J &= T_B + \Psi_{JB} \times P_D \end{aligned} \quad (4)$$

where:

- $P_D$  is the power dissipated as shown in 式 2
- $T_T$  is the temperature at the center-top of the device package
- $T_B$  is the PCB surface temperature measured 1mm from the device package and centered on the package edge

## 7.2 Typical Application



図 7-4. TLV755P Typical Application

### 7.2.1 Design Requirements

表 7-1 lists the design requirements for this application.

表 7-1. Design Parameters

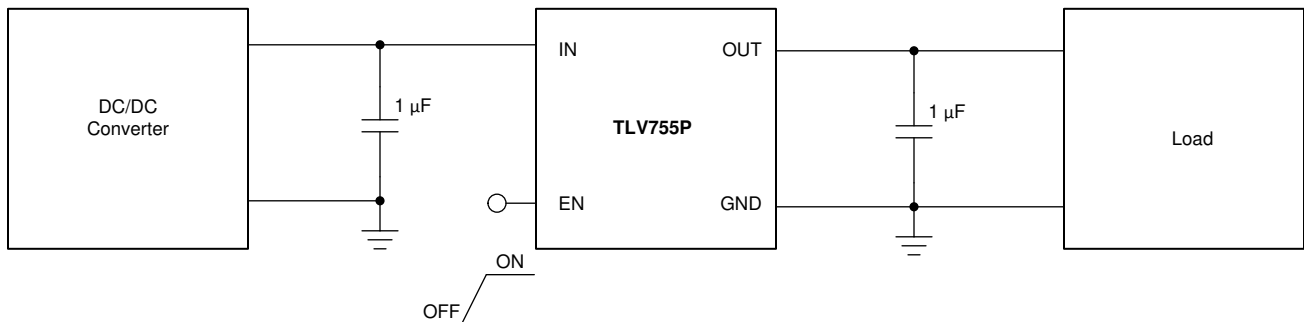
PARAMETER	DESIGN REQUIREMENT
Input voltage	4.3V
Output voltage	3.3V
Input current	500mA (maximum)
Output load	250mA DC
Maximum ambient temperature	70°C

## 7.2.2 Detailed Design Procedure

### 7.2.2.1 Input Current

During normal operation, the input current to the LDO is approximately equal to the output current of the LDO. During start-up, the input current is higher as a result of the inrush current charging the output capacitor. Use 式 5 to calculate the current through the input.

$$I_{OUT(t)} = \left[ \frac{C_{OUT} \times dV_{OUT}(t)}{dt} \right] + \left[ \frac{V_{OUT}(t)}{R_{LOAD}} \right] \quad (5)$$

where:

- $V_{OUT}(t)$  is the instantaneous output voltage of the turn-on ramp
- $dV_{OUT}(t) / dt$  is the slope of the  $V_{OUT}$  ramp
- $R_{LOAD}$  is the resistive load impedance

### 7.2.2.2 Thermal Dissipation

Junction temperature is determined using the junction-to-ambient thermal resistance ( $R_{\theta JA}$ ) and the total power dissipation ( $P_D$ ). Use 式 6 to calculate the power dissipation. Multiply  $P_D$  by  $R_{\theta JA}$  as 式 7 shows and add the ambient temperature ( $T_A$ ) to calculate the junction temperature ( $T_J$ ).

$$P_D = (I_{GND} + I_{OUT}) \times (V_{IN} - V_{OUT}) \quad (6)$$

$$T_J = R_{\theta JA} \times P_D + T_A \quad (7)$$

Calculate the maximum ambient temperature as 式 8 shows if the ( $T_{J(MAX)}$ ) value does not exceed 125°C. 式 9 calculates the maximum ambient temperature with a value of 99.95°C.

$$T_{A(MAX)} = T_{J(MAX)} - R_{\theta JA} \times P_D \quad (8)$$

$$T_{A(MAX)} = 125^\circ\text{C} - 100.2^\circ\text{C/W} \times (4.3\text{V} - 3.3\text{V}) \times (0.25\text{A}) = 99.95^\circ\text{C} \quad (9)$$

### 7.2.3 Application Curve

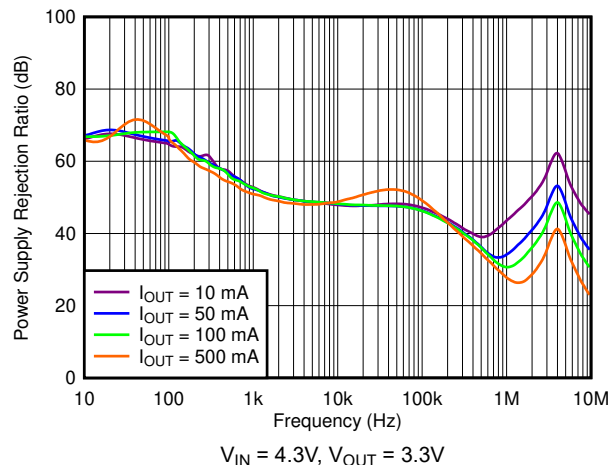

☒ 7-5. PSRR vs Frequency (4.3V to 3.3V)

## 7.3 Power Supply Recommendations

Connect a low output impedance power supply directly to the IN pin of the TLV755P. If the input source is reactive, consider using multiple input capacitors in parallel with the 1  $\mu$ F input capacitor to lower the input supply impedance over frequency.

## 7.4 Layout

### 7.4.1 Layout Guidelines

- Place input and output capacitors as close as possible to the device.
- Use copper planes for device connections to optimize thermal performance.
- Place thermal vias around the device to distribute the heat.
- For packages with thermal pads, solder the thermal pad to copper to achieve best thermal resistance. Thermal resistance increases significantly when the thermal pad is not soldered.

### 7.4.2 Layout Examples

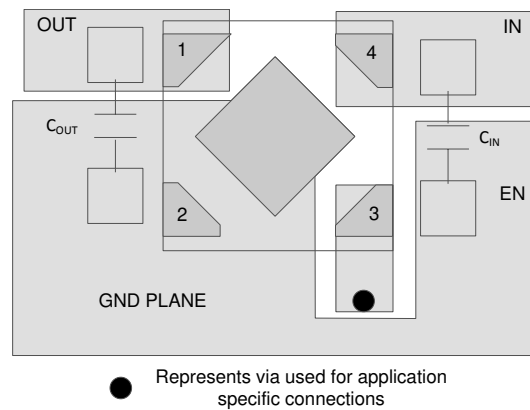

**7-6. Layout Example for the DQN Package**

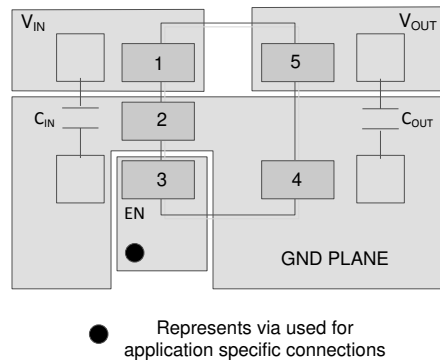

**7-7. Layout Example for the DBV Package**

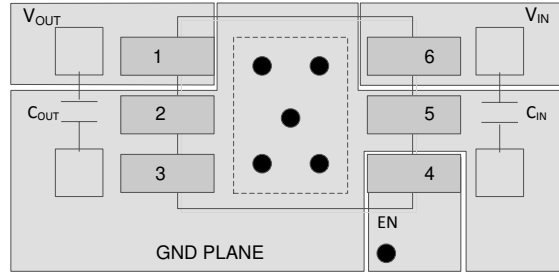

● Represents via used for application specific connections

**7-8. Layout Example for the DRV Package**

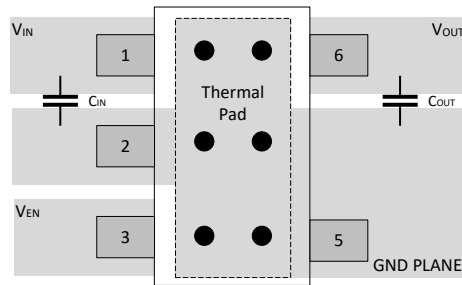

● Represents via used for application specific connections

**7-9. Layout Example for the DYD Package**

## 8 Device and Documentation Support

### 8.1 Device Support

#### 8.1.1 Device Nomenclature

表 8-1. Device Nomenclature

PRODUCT <sup>(1) (2)</sup>	DESCRIPTION
TLV755xx(x)Pyyyz(M3)	<p><b>xx(x)</b> is the nominal output voltage. For output voltages with a resolution of 100mV, two digits are used in the ordering number; otherwise, three digits are used (for example, 28 = 2.8V; 125 = 1.25V).</p> <p><b>P</b> indicates an active output discharge feature. All members of the TLV755P family actively discharge the output when the device is disabled.</p> <p><b>yyy</b> is the package designator.</p> <p><b>z</b> is the package quantity. R is for reel (3000 pieces), T is for tape (250 pieces).</p> <p><b>M3</b> is a suffix designator for devices that only use the latest manufacturing flow.</p>

(1) For the most current package and ordering information see the Package Option Addendum at the end of this document, or visit the device product folder on [www.ti.com](http://www.ti.com).

(2) Output voltages from 0.6V to 5V in 50mV increments are available. Contact the factory for details and availability.

### 8.2 ドキュメントの更新通知を受け取る方法

ドキュメントの更新についての通知を受け取るには、[www.tij.co.jp](http://www.tij.co.jp) のデバイス製品フォルダを開いてください。[通知] をクリックして登録すると、変更されたすべての製品情報に関するダイジェストを毎週受け取ることができます。変更の詳細については、改訂されたドキュメントに含まれている改訂履歴をご覧ください。

### 8.3 サポート・リソース

テキサス・インスツルメンツ E2E™ サポート・フォーラムは、エンジニアが検証済みの回答と設計に関するヒントをエキスパートから迅速かつ直接得ることができる場所です。既存の回答を検索したり、独自の質問をしたりすることで、設計に必要な支援を迅速に得ることができます。

リンクされているコンテンツは、各寄稿者により「現状のまま」提供されるものです。これらはテキサス・インスツルメンツの仕様を構成するものではなく、必ずしもテキサス・インスツルメンツの見解を反映したものではありません。テキサス・インスツルメンツの[使用条件](#)を参照してください。

### 8.4 Trademarks

テキサス・インスツルメンツ E2E™ is a trademark of Texas Instruments.

すべての商標は、それぞれの所有者に帰属します。

### 8.5 静電気放電に関する注意事項



この IC は、ESD によって破損する可能性があります。テキサス・インスツルメンツは、IC を取り扱う際には常に適切な注意を払うことを推奨します。正しい取り扱いおよび設置手順に従わない場合、デバイスを破損するおそれがあります。

ESD による破損は、わずかな性能低下からデバイスの完全な故障まで多岐にわたります。精密な IC の場合、パラメータがわずかに変化するだけで公表されている仕様から外れる可能性があるため、破損が発生しやすくなっています。

### 8.6 用語集

テキサス・インスツルメンツ用語集

この用語集には、用語や略語の一覧および定義が記載されています。

## 9 Revision History

資料番号末尾の英字は改訂を表しています。その改訂履歴は英語版に準じています。

Changes from Revision C (March 2024) to Revision D (September 2024)	Page
• ドキュメント全体にわたって表、図、相互参照の採番方法を更新.....	1
• Changed 3.3V, 1mA to 500mA Load Transient and Load Regulation vs $I_{OUT}$ curves.....	7
• Added M3 information to <i>Device Nomenclature</i> table.....	23

Changes from Revision B (November 2023) to Revision C (March 2024)	Page
• SOT-23 (DYD) を「事前情報」から「量産データ」に変更 .....	1
• SOT-23 (DYD)「特長」パッケージの箇条書き項目を追加 .....	1
• Added last bullet item to <i>Layout Guidelines</i> .....	21
• Added <i>Layout Example for the DYD Package</i> figure.....	21

## 10 Mechanical, Packaging, and Orderable Information

The following pages include mechanical, packaging, and orderable information. This information is the most current data available for the designated devices. This data is subject to change without notice and revision of this document. For browser-based versions of this data sheet, refer to the left-hand navigation.



## 重要なお知らせと免責事項

テキサス・インスツルメンツは、技術データと信頼性データ (データシートを含みます)、設計リソース (リファレンス デザインを含みます)、アプリケーションや設計に関する各種アドバイス、Web ツール、安全性情報、その他のリソースを、欠陥が存在する可能性のある「現状のまま」提供しており、商品性および特定目的に対する適合性の黙示保証、第三者の知的財産権の非侵害保証を含むいかなる保証も、明示的または黙示的にかかわらず拒否します。

これらのリソースは、テキサス・インスツルメンツ製品を使用する設計の経験を積んだ開発者への提供を意図したものです。(1) お客様のアプリケーションに適した テキサス・インスツルメンツ製品の選定、(2) お客様のアプリケーションの設計、検証、試験、(3) お客様のアプリケーションに該当する各種規格や、その他のあらゆる安全性、セキュリティ、規制、または他の要件への確実な適合に関する責任を、お客様のみが単独で負うものとします。

上記の各種リソースは、予告なく変更される可能性があります。これらのリソースは、リソースで説明されている テキサス・インスツルメンツ製品を使用するアプリケーションの開発の目的でのみ、テキサス・インスツルメンツはその使用をお客様に許諾します。これらのリソースに関して、他の目的で複製することや掲載することは禁止されています。テキサス・インスツルメンツや第三者の知的財産権のライセンスが付与されている訳ではありません。お客様は、これらのリソースを自身で使用した結果発生するあらゆる申し立て、損害、費用、損失、責任について、テキサス・インスツルメンツおよびその代理人を完全に補償するものとし、テキサス・インスツルメンツは一切の責任を拒否します。

テキサス・インスツルメンツの製品は、[テキサス・インスツルメンツの販売条件](#)、または [ti.com](https://www.ti.com) やかかる テキサス・インスツルメンツ製品の関連資料などのいずれかを通じて提供する適用可能な条項の下で提供されています。テキサス・インスツルメンツがこれらのリソースを提供することは、適用されるテキサス・インスツルメンツの保証または他の保証の放棄の拡大や変更を意味するものではありません。

お客様がいかなる追加条項または代替条項を提案した場合でも、テキサス・インスツルメンツはそれらに異議を唱え、拒否します。

郵送先住所: Texas Instruments, Post Office Box 655303, Dallas, Texas 75265

Copyright © 2024, Texas Instruments Incorporated

**PACKAGING INFORMATION**

Orderable part number	Status (1)	Material type (2)	Package   Pins	Package qty   Carrier	RoHS (3)	Lead finish/ Ball material (4)	MSL rating/ Peak reflow (5)	Op temp (°C)	Part marking (6)
<a href="#">TLV755075PDQNR</a>	Active	Production	X2SON (DQN)   4	3000   LARGE T&R	Yes	NIPDAU	Level-1-260C-UNLIM	-40 to 105	DJ
TLV755075PDQNR.A	Active	Production	X2SON (DQN)   4	3000   LARGE T&R	Yes	NIPDAU	Level-1-260C-UNLIM	-40 to 125	DJ
<a href="#">TLV75507PDQNR</a>	Active	Production	X2SON (DQN)   4	3000   LARGE T&R	Yes	NIPDAU   NIPDAUAG	Level-1-260C-UNLIM	-40 to 125	KD
TLV75507PDQNR.A	Active	Production	X2SON (DQN)   4	3000   LARGE T&R	Yes	NIPDAU	Level-1-260C-UNLIM	-40 to 125	KD
<a href="#">TLV75507PDQNT</a>	Active	Production	X2SON (DQN)   4	250   SMALL T&R	Yes	NIPDAU   NIPDAUAG	Level-1-260C-UNLIM	-40 to 125	KD
TLV75507PDQNT.A	Active	Production	X2SON (DQN)   4	250   SMALL T&R	Yes	NIPDAU	Level-1-260C-UNLIM	-40 to 125	KD
<a href="#">TLV75509PDBVR</a>	Active	Production	SOT-23 (DBV)   5	3000   LARGE T&R	Yes	NIPDAU   SN	Level-1-260C-UNLIM	-40 to 125	1HAF
TLV75509PDBVR.A	Active	Production	SOT-23 (DBV)   5	3000   LARGE T&R	Yes	NIPDAU	Level-1-260C-UNLIM	-40 to 125	1HAF
<a href="#">TLV75509PDQNR</a>	Active	Production	X2SON (DQN)   4	3000   LARGE T&R	Yes	NIPDAU   NIPDAUAG	Level-1-260C-UNLIM	-40 to 125	AX
TLV75509PDQNR.A	Active	Production	X2SON (DQN)   4	3000   LARGE T&R	Yes	NIPDAU	Level-1-260C-UNLIM	-40 to 125	AX
<a href="#">TLV75509PDQNT</a>	Active	Production	X2SON (DQN)   4	250   SMALL T&R	Yes	NIPDAU   NIPDAUAG	Level-1-260C-UNLIM	-40 to 125	AX
TLV75509PDQNT.A	Active	Production	X2SON (DQN)   4	250   SMALL T&R	Yes	NIPDAU	Level-1-260C-UNLIM	-40 to 125	AX
<a href="#">TLV75509PDRVR</a>	Active	Production	WSON (DRV)   6	3000   LARGE T&R	Yes	NIPDAU	Level-1-260C-UNLIM	-40 to 125	1HDH
TLV75509PDRVR.A	Active	Production	WSON (DRV)   6	3000   LARGE T&R	Yes	NIPDAU	Level-1-260C-UNLIM	-40 to 125	1HDH
<a href="#">TLV75509PDYDR</a>	Active	Production	SOT-23 (DYD)   5	3000   LARGE T&R	Yes	SN	Level-1-260C-UNLIM	-40 to 125	3DPH
TLV75509PDYDR.A	Active	Production	SOT-23 (DYD)   5	3000   LARGE T&R	Yes	SN	Level-1-260C-UNLIM	-40 to 125	3DPH
<a href="#">TLV75510PDBVR</a>	Active	Production	SOT-23 (DBV)   5	3000   LARGE T&R	Yes	NIPDAU   SN	Level-1-260C-UNLIM	-40 to 125	1FPF
TLV75510PDBVR.A	Active	Production	SOT-23 (DBV)   5	3000   LARGE T&R	Yes	NIPDAU	Level-1-260C-UNLIM	-40 to 125	1FPF
TLV75510PDBVRG4	Active	Production	SOT-23 (DBV)   5	3000   LARGE T&R	Yes	NIPDAU	Level-1-260C-UNLIM	-40 to 125	1FPF
TLV75510PDBVRG4.A	Active	Production	SOT-23 (DBV)   5	3000   LARGE T&R	Yes	NIPDAU	Level-1-260C-UNLIM	-40 to 125	1FPF
<a href="#">TLV75510PDQNR</a>	Active	Production	X2SON (DQN)   4	3000   LARGE T&R	Yes	NIPDAU   NIPDAUAG	Level-1-260C-UNLIM	-40 to 125	KE
TLV75510PDQNR.A	Active	Production	X2SON (DQN)   4	3000   LARGE T&R	Yes	NIPDAUAG	Level-1-260C-UNLIM	-40 to 125	KE
<a href="#">TLV75510PDQNRM3</a>	Active	Production	X2SON (DQN)   4	3000   LARGE T&R	Yes	NIPDAU	Level-1-260C-UNLIM	-40 to 125	KE
TLV75510PDQNRM3.A	Active	Production	X2SON (DQN)   4	3000   LARGE T&R	Yes	NIPDAU	Level-1-260C-UNLIM	-40 to 125	KE
<a href="#">TLV75510PDQNT</a>	Active	Production	X2SON (DQN)   4	250   SMALL T&R	Yes	NIPDAU   NIPDAUAG	Level-1-260C-UNLIM	-40 to 125	KE
TLV75510PDQNT.A	Active	Production	X2SON (DQN)   4	250   SMALL T&R	Yes	NIPDAUAG	Level-1-260C-UNLIM	-40 to 125	KE
<a href="#">TLV75510PDRVR</a>	Active	Production	WSON (DRV)   6	3000   LARGE T&R	Yes	NIPDAU	Level-1-260C-UNLIM	-40 to 125	1GUH
TLV75510PDRVR.A	Active	Production	WSON (DRV)   6	3000   LARGE T&R	Yes	NIPDAU	Level-1-260C-UNLIM	-40 to 125	1GUH
TLV75510PDRVRG4	Active	Production	WSON (DRV)   6	3000   LARGE T&R	Yes	NIPDAU	Level-1-260C-UNLIM	-40 to 125	1GUH

Orderable part number	Status (1)	Material type (2)	Package   Pins	Package qty   Carrier	RoHS (3)	Lead finish/ Ball material (4)	MSL rating/ Peak reflow (5)	Op temp (°C)	Part marking (6)
TLV75510PDRVRG4.A	Active	Production	WSON (DRV)   6	3000   LARGE T&R	Yes	NIPDAU	Level-1-260C-UNLIM	-40 to 125	1GUH
<a href="#">TLV75511PDQNR</a>	Active	Production	X2SON (DQN)   4	3000   LARGE T&R	Yes	NIPDAU	Level-1-260C-UNLIM	-40 to 125	E8
TLV75511PDQNR.A	Active	Production	X2SON (DQN)   4	3000   LARGE T&R	Yes	NIPDAU	Level-1-260C-UNLIM	-40 to 125	E8
<a href="#">TLV75512PDBVR</a>	Active	Production	SOT-23 (DBV)   5	3000   LARGE T&R	Yes	NIPDAU   SN	Level-1-260C-UNLIM	-40 to 125	1FQF
TLV75512PDBVR.A	Active	Production	SOT-23 (DBV)   5	3000   LARGE T&R	Yes	NIPDAU	Level-1-260C-UNLIM	-40 to 125	1FQF
TLV75512PDBVRG4	Active	Production	SOT-23 (DBV)   5	3000   LARGE T&R	Yes	NIPDAU	Level-1-260C-UNLIM	-40 to 125	1FQF
TLV75512PDBVRG4.A	Active	Production	SOT-23 (DBV)   5	3000   LARGE T&R	Yes	NIPDAU	Level-1-260C-UNLIM	-40 to 125	1FQF
<a href="#">TLV75512PDQNR</a>	Active	Production	X2SON (DQN)   4	3000   LARGE T&R	Yes	NIPDAU   NIPDAUAG	Level-1-260C-UNLIM	-40 to 125	AG
TLV75512PDQNR.A	Active	Production	X2SON (DQN)   4	3000   LARGE T&R	Yes	NIPDAUAG	Level-1-260C-UNLIM	-40 to 125	AG
<a href="#">TLV75512PDQNRM3</a>	Active	Production	X2SON (DQN)   4	3000   LARGE T&R	Yes	NIPDAU	Level-1-260C-UNLIM	-40 to 125	AG
TLV75512PDQNRM3.A	Active	Production	X2SON (DQN)   4	3000   LARGE T&R	Yes	NIPDAU	Level-1-260C-UNLIM	-40 to 125	AG
<a href="#">TLV75512PDQNT</a>	Active	Production	X2SON (DQN)   4	250   SMALL T&R	Yes	NIPDAU   NIPDAUAG	Level-1-260C-UNLIM	-40 to 125	AG
TLV75512PDQNT.A	Active	Production	X2SON (DQN)   4	250   SMALL T&R	Yes	NIPDAUAG	Level-1-260C-UNLIM	-40 to 125	AG
<a href="#">TLV75512PDRVR</a>	Active	Production	WSON (DRV)   6	3000   LARGE T&R	Yes	NIPDAU	Level-1-260C-UNLIM	-40 to 125	1GVH
TLV75512PDRVR.A	Active	Production	WSON (DRV)   6	3000   LARGE T&R	Yes	NIPDAU	Level-1-260C-UNLIM	-40 to 125	1GVH
<a href="#">TLV75512PDYDR</a>	Active	Production	SOT-23 (DYD)   5	3000   LARGE T&R	Yes	SN	Level-1-260C-UNLIM	-40 to 125	3DQH
TLV75512PDYDR.A	Active	Production	SOT-23 (DYD)   5	3000   LARGE T&R	Yes	SN	Level-1-260C-UNLIM	-40 to 125	3DQH
<a href="#">TLV75515PDBVR</a>	Active	Production	SOT-23 (DBV)   5	3000   LARGE T&R	Yes	NIPDAU   SN	Level-1-260C-UNLIM	-40 to 125	1FRF
TLV75515PDBVR.A	Active	Production	SOT-23 (DBV)   5	3000   LARGE T&R	Yes	NIPDAU	Level-1-260C-UNLIM	-40 to 125	1FRF
<a href="#">TLV75515PDQNR</a>	Active	Production	X2SON (DQN)   4	3000   LARGE T&R	Yes	NIPDAU   NIPDAUAG	Level-1-260C-UNLIM	-40 to 125	KF
TLV75515PDQNR.A	Active	Production	X2SON (DQN)   4	3000   LARGE T&R	Yes	NIPDAU	Level-1-260C-UNLIM	-40 to 125	KF
<a href="#">TLV75515PDQNT</a>	Active	Production	X2SON (DQN)   4	250   SMALL T&R	Yes	NIPDAU   NIPDAUAG	Level-1-260C-UNLIM	-40 to 125	KF
TLV75515PDQNT.A	Active	Production	X2SON (DQN)   4	250   SMALL T&R	Yes	NIPDAU	Level-1-260C-UNLIM	-40 to 125	KF
<a href="#">TLV75515PDRVR</a>	Active	Production	WSON (DRV)   6	3000   LARGE T&R	Yes	NIPDAU	Level-1-260C-UNLIM	-40 to 125	1GWH
TLV75515PDRVR.A	Active	Production	WSON (DRV)   6	3000   LARGE T&R	Yes	NIPDAU	Level-1-260C-UNLIM	-40 to 125	1GWH
<a href="#">TLV755185PDQNR</a>	Active	Production	X2SON (DQN)   4	3000   LARGE T&R	Yes	NIPDAU	Level-1-260C-UNLIM	-40 to 125	EZ
TLV755185PDQNR.A	Active	Production	X2SON (DQN)   4	3000   LARGE T&R	Yes	NIPDAU	Level-1-260C-UNLIM	-40 to 125	EZ
<a href="#">TLV755185PDQNRM3</a>	Active	Production	X2SON (DQN)   4	3000   LARGE T&R	Yes	NIPDAU	Level-1-260C-UNLIM	-40 to 125	EZ
TLV755185PDQNRM3.A	Active	Production	X2SON (DQN)   4	3000   LARGE T&R	Yes	NIPDAU	Level-1-260C-UNLIM	-40 to 125	EZ
<a href="#">TLV75518PDBVR</a>	Active	Production	SOT-23 (DBV)   5	3000   LARGE T&R	Yes	NIPDAU   SN	Level-1-260C-UNLIM	-40 to 125	1FSF
TLV75518PDBVR.A	Active	Production	SOT-23 (DBV)   5	3000   LARGE T&R	Yes	NIPDAU	Level-1-260C-UNLIM	-40 to 125	1FSF

Orderable part number	Status (1)	Material type (2)	Package   Pins	Package qty   Carrier	RoHS (3)	Lead finish/ Ball material (4)	MSL rating/ Peak reflow (5)	Op temp (°C)	Part marking (6)
<a href="#">TLV75518PDQNR</a>	Active	Production	X2SON (DQN)   4	3000   LARGE T&R	Yes	NIPDAU   NIPDAUAG	Level-1-260C-UNLIM	-40 to 125	AI
TLV75518PDQNR.A	Active	Production	X2SON (DQN)   4	3000   LARGE T&R	Yes	NIPDAU	Level-1-260C-UNLIM	-40 to 125	AI
TLV75518PDQNRG4	Active	Production	X2SON (DQN)   4	3000   LARGE T&R	Yes	NIPDAU	Level-1-260C-UNLIM	-40 to 125	AI
TLV75518PDQNRG4.A	Active	Production	X2SON (DQN)   4	3000   LARGE T&R	Yes	NIPDAU	Level-1-260C-UNLIM	-40 to 125	AI
<a href="#">TLV75518PDQNT</a>	Active	Production	X2SON (DQN)   4	250   SMALL T&R	Yes	NIPDAU   NIPDAUAG	Level-1-260C-UNLIM	-40 to 125	AI
TLV75518PDQNT.A	Active	Production	X2SON (DQN)   4	250   SMALL T&R	Yes	NIPDAU	Level-1-260C-UNLIM	-40 to 125	AI
<a href="#">TLV75518PDRVR</a>	Active	Production	WSON (DRV)   6	3000   LARGE T&R	Yes	NIPDAU	Level-1-260C-UNLIM	-40 to 125	1GXH
TLV75518PDRVR.A	Active	Production	WSON (DRV)   6	3000   LARGE T&R	Yes	NIPDAU	Level-1-260C-UNLIM	-40 to 125	1GXH
<a href="#">TLV75518PDYDR</a>	Active	Production	SOT-23 (DYD)   5	3000   LARGE T&R	Yes	SN	Level-1-260C-UNLIM	-40 to 125	3DRH
TLV75518PDYDR.A	Active	Production	SOT-23 (DYD)   5	3000   LARGE T&R	Yes	SN	Level-1-260C-UNLIM	-40 to 125	3DRH
<a href="#">TLV75519PDBVR</a>	Active	Production	SOT-23 (DBV)   5	3000   LARGE T&R	Yes	NIPDAU   SN	Level-1-260C-UNLIM	-40 to 125	1HBF
TLV75519PDBVR.A	Active	Production	SOT-23 (DBV)   5	3000   LARGE T&R	Yes	SN	Level-1-260C-UNLIM	-40 to 125	1HBF
<a href="#">TLV75519PDQNR</a>	Active	Production	X2SON (DQN)   4	3000   LARGE T&R	Yes	NIPDAU   NIPDAUAG	Level-1-260C-UNLIM	-40 to 125	B5
TLV75519PDQNR.A	Active	Production	X2SON (DQN)   4	3000   LARGE T&R	Yes	NIPDAU	Level-1-260C-UNLIM	-40 to 125	B5
TLV75519PDQNRG4	Active	Production	X2SON (DQN)   4	3000   LARGE T&R	Yes	NIPDAU	Level-1-260C-UNLIM	-40 to 125	B5
TLV75519PDQNRG4.A	Active	Production	X2SON (DQN)   4	3000   LARGE T&R	Yes	NIPDAU	Level-1-260C-UNLIM	-40 to 125	B5
<a href="#">TLV75519PDQNT</a>	Active	Production	X2SON (DQN)   4	250   SMALL T&R	Yes	NIPDAU   NIPDAUAG	Level-1-260C-UNLIM	-40 to 125	B5
TLV75519PDQNT.A	Active	Production	X2SON (DQN)   4	250   SMALL T&R	Yes	NIPDAU	Level-1-260C-UNLIM	-40 to 125	B5
<a href="#">TLV75519PDRVR</a>	Active	Production	WSON (DRV)   6	3000   LARGE T&R	Yes	NIPDAU   SELECTIVE AG (TOP SIDE)	Level-1-260C-UNLIM	-40 to 125	1HEH
TLV75519PDRVR.A	Active	Production	WSON (DRV)   6	3000   LARGE T&R	Yes	SELECTIVE AG (TOP SIDE)	Level-1-260C-UNLIM	-40 to 125	1HEH
<a href="#">TLV75525PDBVR</a>	Active	Production	SOT-23 (DBV)   5	3000   LARGE T&R	Yes	NIPDAU   SN	Level-1-260C-UNLIM	-40 to 125	1FTF
TLV75525PDBVR.A	Active	Production	SOT-23 (DBV)   5	3000   LARGE T&R	Yes	SN	Level-1-260C-UNLIM	-40 to 125	1FTF
<a href="#">TLV75525PDQNR</a>	Active	Production	X2SON (DQN)   4	3000   LARGE T&R	Yes	NIPDAU   NIPDAUAG	Level-1-260C-UNLIM	-40 to 125	AJ
TLV75525PDQNR.A	Active	Production	X2SON (DQN)   4	3000   LARGE T&R	Yes	NIPDAU	Level-1-260C-UNLIM	-40 to 125	AJ
<a href="#">TLV75525PDQNT</a>	Active	Production	X2SON (DQN)   4	250   SMALL T&R	Yes	NIPDAU   NIPDAUAG	Level-1-260C-UNLIM	-40 to 125	AJ
TLV75525PDQNT.A	Active	Production	X2SON (DQN)   4	250   SMALL T&R	Yes	NIPDAU	Level-1-260C-UNLIM	-40 to 125	AJ
<a href="#">TLV75525PDRVR</a>	Active	Production	WSON (DRV)   6	3000   LARGE T&R	Yes	NIPDAU	Level-1-260C-UNLIM	-40 to 125	1GZH
TLV75525PDRVR.A	Active	Production	WSON (DRV)   6	3000   LARGE T&R	Yes	NIPDAU	Level-1-260C-UNLIM	-40 to 125	1GZH
TLV75525PDRVRG4	Active	Production	WSON (DRV)   6	3000   LARGE T&R	Yes	NIPDAU	Level-1-260C-UNLIM	-40 to 125	1GZH

Orderable part number	Status (1)	Material type (2)	Package   Pins	Package qty   Carrier	RoHS (3)	Lead finish/ Ball material (4)	MSL rating/ Peak reflow (5)	Op temp (°C)	Part marking (6)
TLV75525PDRVRG4.A	Active	Production	WSON (DRV)   6	3000   LARGE T&R	Yes	NIPDAU	Level-1-260C-UNLIM	-40 to 125	1GZH
<a href="#">TLV75525PDYDR</a>	Active	Production	SOT-23 (DYD)   5	3000   LARGE T&R	Yes	SN	Level-1-260C-UNLIM	-40 to 125	3DSH
TLV75525PDYDR.A	Active	Production	SOT-23 (DYD)   5	3000   LARGE T&R	Yes	SN	Level-1-260C-UNLIM	-40 to 125	3DSH
<a href="#">TLV75528PDBVR</a>	Active	Production	SOT-23 (DBV)   5	3000   LARGE T&R	Yes	NIPDAU   SN	Level-1-260C-UNLIM	-40 to 125	1FUF
TLV75528PDBVR.A	Active	Production	SOT-23 (DBV)   5	3000   LARGE T&R	Yes	SN	Level-1-260C-UNLIM	-40 to 125	1FUF
<a href="#">TLV75528PDQNR</a>	Active	Production	X2SON (DQN)   4	3000   LARGE T&R	Yes	NIPDAU   NIPDAUAG	Level-1-260C-UNLIM	-40 to 125	KG
TLV75528PDQNR.A	Active	Production	X2SON (DQN)   4	3000   LARGE T&R	Yes	NIPDAU	Level-1-260C-UNLIM	-40 to 125	KG
<a href="#">TLV75528PDQNT</a>	Active	Production	X2SON (DQN)   4	250   SMALL T&R	Yes	NIPDAU   NIPDAUAG	Level-1-260C-UNLIM	-40 to 125	KG
TLV75528PDQNT.A	Active	Production	X2SON (DQN)   4	250   SMALL T&R	Yes	NIPDAU	Level-1-260C-UNLIM	-40 to 125	KG
<a href="#">TLV75528PDRVR</a>	Active	Production	WSON (DRV)   6	3000   LARGE T&R	Yes	NIPDAU	Level-1-260C-UNLIM	-40 to 125	1H1H
TLV75528PDRVR.A	Active	Production	WSON (DRV)   6	3000   LARGE T&R	Yes	NIPDAU	Level-1-260C-UNLIM	-40 to 125	1H1H
<a href="#">TLV75528PDYDR</a>	Active	Production	SOT-23 (DYD)   5	3000   LARGE T&R	Yes	SN	Level-1-260C-UNLIM	-40 to 125	3DTH
TLV75528PDYDR.A	Active	Production	SOT-23 (DYD)   5	3000   LARGE T&R	Yes	SN	Level-1-260C-UNLIM	-40 to 125	3DTH
<a href="#">TLV75529PDBVR</a>	Active	Production	SOT-23 (DBV)   5	3000   LARGE T&R	Yes	NIPDAU   SN	Level-1-260C-UNLIM	-40 to 125	1HCF
TLV75529PDBVR.A	Active	Production	SOT-23 (DBV)   5	3000   LARGE T&R	Yes	SN	Level-1-260C-UNLIM	-40 to 125	1HCF
<a href="#">TLV75529PDRVR</a>	Active	Production	WSON (DRV)   6	3000   LARGE T&R	Yes	NIPDAU   SELECTIVE AG (TOP SIDE)	Level-1-260C-UNLIM	-40 to 125	1HFH
TLV75529PDRVR.A	Active	Production	WSON (DRV)   6	3000   LARGE T&R	Yes	SELECTIVE AG (TOP SIDE)	Level-1-260C-UNLIM	-40 to 125	1HFH
<a href="#">TLV75530PDBVR</a>	Active	Production	SOT-23 (DBV)   5	3000   LARGE T&R	Yes	NIPDAU   SN	Level-1-260C-UNLIM	-40 to 125	1FVF
TLV75530PDBVR.A	Active	Production	SOT-23 (DBV)   5	3000   LARGE T&R	Yes	SN	Level-1-260C-UNLIM	-40 to 125	1FVF
<a href="#">TLV75530PDQNR</a>	Active	Production	X2SON (DQN)   4	3000   LARGE T&R	Yes	NIPDAU   NIPDAUAG	Level-1-260C-UNLIM	-40 to 125	KI
TLV75530PDQNR.A	Active	Production	X2SON (DQN)   4	3000   LARGE T&R	Yes	NIPDAU	Level-1-260C-UNLIM	-40 to 125	KI
<a href="#">TLV75530PDQNT</a>	Active	Production	X2SON (DQN)   4	250   SMALL T&R	Yes	NIPDAU   NIPDAUAG	Level-1-260C-UNLIM	-40 to 125	KI
TLV75530PDQNT.A	Active	Production	X2SON (DQN)   4	250   SMALL T&R	Yes	NIPDAU	Level-1-260C-UNLIM	-40 to 125	KI
TLV75530PDQNTG4	Active	Production	X2SON (DQN)   4	250   SMALL T&R	Yes	NIPDAU	Level-1-260C-UNLIM	-40 to 125	KI
TLV75530PDQNTG4.A	Active	Production	X2SON (DQN)   4	250   SMALL T&R	Yes	NIPDAU	Level-1-260C-UNLIM	-40 to 125	KI
<a href="#">TLV75530PDRVR</a>	Active	Production	WSON (DRV)   6	3000   LARGE T&R	Yes	NIPDAU	Level-1-260C-UNLIM	-40 to 125	1H2H
TLV75530PDRVR.A	Active	Production	WSON (DRV)   6	3000   LARGE T&R	Yes	NIPDAU	Level-1-260C-UNLIM	-40 to 125	1H2H
<a href="#">TLV75532PDQNR</a>	Active	Production	X2SON (DQN)   4	3000   LARGE T&R	Yes	SELECTIVE AG (TOP SIDE)	Level-1-260C-UNLIM	-40 to 125	TD

Orderable part number	Status (1)	Material type (2)	Package   Pins	Package qty   Carrier	RoHS (3)	Lead finish/ Ball material (4)	MSL rating/ Peak reflow (5)	Op temp (°C)	Part marking (6)
<a href="#">TLV75533PDBVR</a>	Active	Production	SOT-23 (DBV)   5	3000   LARGE T&R	Yes	NIPDAU   SN	Level-1-260C-UNLIM	-40 to 125	1FWF
TLV75533PDBVR.A	Active	Production	SOT-23 (DBV)   5	3000   LARGE T&R	Yes	NIPDAU	Level-1-260C-UNLIM	-40 to 125	1FWF
<a href="#">TLV75533PDQNR</a>	Active	Production	X2SON (DQN)   4	3000   LARGE T&R	Yes	NIPDAU   NIPDAUAG	Level-1-260C-UNLIM	-40 to 125	AN
TLV75533PDQNR.A	Active	Production	X2SON (DQN)   4	3000   LARGE T&R	Yes	NIPDAUAG	Level-1-260C-UNLIM	-40 to 125	AN
TLV75533PDQNRG4	Active	Production	X2SON (DQN)   4	3000   LARGE T&R	Yes	NIPDAU	Level-1-260C-UNLIM	-40 to 125	AN
TLV75533PDQNRG4.A	Active	Production	X2SON (DQN)   4	3000   LARGE T&R	Yes	NIPDAU	Level-1-260C-UNLIM	-40 to 125	AN
<a href="#">TLV75533PDQNRM3</a>	Active	Production	X2SON (DQN)   4	3000   LARGE T&R	Yes	NIPDAU	Level-1-260C-UNLIM	-40 to 125	AN
TLV75533PDQNRM3.A	Active	Production	X2SON (DQN)   4	3000   LARGE T&R	Yes	NIPDAU	Level-1-260C-UNLIM	-40 to 125	AN
<a href="#">TLV75533PDQNT</a>	Active	Production	X2SON (DQN)   4	250   SMALL T&R	Yes	NIPDAU   NIPDAUAG	Level-1-260C-UNLIM	-40 to 125	AN
TLV75533PDQNT.A	Active	Production	X2SON (DQN)   4	250   SMALL T&R	Yes	NIPDAUAG	Level-1-260C-UNLIM	-40 to 125	AN
<a href="#">TLV75533PDRVR</a>	Active	Production	WSON (DRV)   6	3000   LARGE T&R	Yes	NIPDAU	Level-1-260C-UNLIM	-40 to 125	1H3H
TLV75533PDRVR.A	Active	Production	WSON (DRV)   6	3000   LARGE T&R	Yes	NIPDAU	Level-1-260C-UNLIM	-40 to 125	1H3H
TLV75533PDRVRG4	Active	Production	WSON (DRV)   6	3000   LARGE T&R	Yes	NIPDAU	Level-1-260C-UNLIM	-40 to 125	1H3H
TLV75533PDRVRG4.A	Active	Production	WSON (DRV)   6	3000   LARGE T&R	Yes	NIPDAU	Level-1-260C-UNLIM	-40 to 125	1H3H
<a href="#">TLV75533PDYDR</a>	Active	Production	SOT-23 (DYD)   5	3000   LARGE T&R	Yes	SN	Level-1-260C-UNLIM	-40 to 125	3DUH
TLV75533PDYDR.A	Active	Production	SOT-23 (DYD)   5	3000   LARGE T&R	Yes	SN	Level-1-260C-UNLIM	-40 to 125	3DUH
<a href="#">TLV755345PDQNR</a>	Active	Production	X2SON (DQN)   4	3000   LARGE T&R	Yes	NIPDAU	Level-1-260C-UNLIM	-40 to 125	DK
TLV755345PDQNR.A	Active	Production	X2SON (DQN)   4	3000   LARGE T&R	Yes	NIPDAU	Level-1-260C-UNLIM	-40 to 125	DK

(1) **Status:** For more details on status, see our [product life cycle](#).

(2) **Material type:** When designated, preproduction parts are prototypes/experimental devices, and are not yet approved or released for full production. Testing and final process, including without limitation quality assurance, reliability performance testing, and/or process qualification, may not yet be complete, and this item is subject to further changes or possible discontinuation. If available for ordering, purchases will be subject to an additional waiver at checkout, and are intended for early internal evaluation purposes only. These items are sold without warranties of any kind.

(3) **RoHS values:** Yes, No, RoHS Exempt. See the [TI RoHS Statement](#) for additional information and value definition.

(4) **Lead finish/Ball material:** Parts may have multiple material finish options. Finish options are separated by a vertical ruled line. Lead finish/Ball material values may wrap to two lines if the finish value exceeds the maximum column width.

(5) **MSL rating/Peak reflow:** The moisture sensitivity level ratings and peak solder (reflow) temperatures. In the event that a part has multiple moisture sensitivity ratings, only the lowest level per JEDEC standards is shown. Refer to the shipping label for the actual reflow temperature that will be used to mount the part to the printed circuit board.

**(6) Part marking:** There may be an additional marking, which relates to the logo, the lot trace code information, or the environmental category of the part.

Multiple part markings will be inside parentheses. Only one part marking contained in parentheses and separated by a "~" will appear on a part. If a line is indented then it is a continuation of the previous line and the two combined represent the entire part marking for that device.

**Important Information and Disclaimer:** The information provided on this page represents TI's knowledge and belief as of the date that it is provided. TI bases its knowledge and belief on information provided by third parties, and makes no representation or warranty as to the accuracy of such information. Efforts are underway to better integrate information from third parties. TI has taken and continues to take reasonable steps to provide representative and accurate information but may not have conducted destructive testing or chemical analysis on incoming materials and chemicals. TI and TI suppliers consider certain information to be proprietary, and thus CAS numbers and other limited information may not be available for release.

In no event shall TI's liability arising out of such information exceed the total purchase price of the TI part(s) at issue in this document sold by TI to Customer on an annual basis.

## TAPE AND REEL INFORMATION



### QUADRANT ASSIGNMENTS FOR PIN 1 ORIENTATION IN TAPE



\*All dimensions are nominal

Device	Package Type	Package Drawing	Pins	SPQ	Reel Diameter (mm)	Reel Width W1 (mm)	A0 (mm)	B0 (mm)	K0 (mm)	P1 (mm)	W (mm)	Pin1 Quadrant
TLV755075PDQNR	X2SON	DQN	4	3000	180.0	8.4	1.16	1.16	0.5	4.0	8.0	Q2
TLV75507PDQNR	X2SON	DQN	4	3000	180.0	8.4	1.16	1.16	0.5	4.0	8.0	Q2
TLV75507PDQNT	X2SON	DQN	4	250	180.0	8.4	1.16	1.16	0.5	4.0	8.0	Q2
TLV75509PDBVR	SOT-23	DBV	5	3000	178.0	8.4	3.2	3.2	1.4	4.0	8.0	Q3
TLV75509PDQNR	X2SON	DQN	4	3000	180.0	8.4	1.16	1.16	0.5	4.0	8.0	Q2
TLV75509PDQNT	X2SON	DQN	4	250	180.0	8.4	1.16	1.16	0.5	4.0	8.0	Q2
TLV75509PDQNT	X2SON	DQN	4	250	180.0	9.5	1.16	1.16	0.5	4.0	8.0	Q2
TLV75509PDQNT	X2SON	DQN	4	250	180.0	8.4	1.16	1.16	0.63	4.0	8.0	Q2
TLV75509PDRVR	WSON	DRV	6	3000	180.0	8.4	2.3	2.3	1.15	4.0	8.0	Q2
TLV75509PDYDR	SOT-23	DYD	5	3000	180.0	8.4	3.2	3.2	1.4	4.0	8.0	Q3
TLV75510PDBVR	SOT-23	DBV	5	3000	180.0	8.4	3.2	3.2	1.4	4.0	8.0	Q3
TLV75510PDBVR	SOT-23	DBV	5	3000	180.0	8.4	3.2	3.2	1.4	4.0	8.0	Q3
TLV75510PDBVRG4	SOT-23	DBV	5	3000	180.0	8.4	3.2	3.2	1.4	4.0	8.0	Q3
TLV75510PDQNR	X2SON	DQN	4	3000	180.0	8.4	1.16	1.16	0.63	4.0	8.0	Q2
TLV75510PDQNR	X2SON	DQN	4	3000	180.0	9.5	1.16	1.16	0.5	4.0	8.0	Q2
TLV75510PDQNRM3	X2SON	DQN	4	3000	180.0	8.4	1.16	1.16	0.5	4.0	8.0	Q2



Device	Package Type	Package Drawing	Pins	SPQ	Reel Diameter (mm)	Reel Width W1 (mm)	A0 (mm)	B0 (mm)	K0 (mm)	P1 (mm)	W (mm)	Pin1 Quadrant
TLV75510PDQNT	X2SON	DQN	4	250	180.0	8.4	1.16	1.16	0.63	4.0	8.0	Q2
TLV75510PDQNT	X2SON	DQN	4	250	180.0	9.5	1.16	1.16	0.5	4.0	8.0	Q2
TLV75510PDRVR	WSON	DRV	6	3000	180.0	8.4	2.3	2.3	1.15	4.0	8.0	Q2
TLV75510PDRVRG4	WSON	DRV	6	3000	180.0	8.4	2.3	2.3	1.15	4.0	8.0	Q2
TLV75511PDQNR	X2SON	DQN	4	3000	180.0	8.4	1.16	1.16	0.5	4.0	8.0	Q2
TLV75512PDBVR	SOT-23	DBV	5	3000	178.0	8.4	3.2	3.2	1.4	4.0	8.0	Q3
TLV75512PDBVRG4	SOT-23	DBV	5	3000	180.0	8.4	3.2	3.2	1.4	4.0	8.0	Q3
TLV75512PDQNR	X2SON	DQN	4	3000	180.0	9.5	1.16	1.16	0.5	4.0	8.0	Q2
TLV75512PDQNRM3	X2SON	DQN	4	3000	180.0	8.4	1.16	1.16	0.5	4.0	8.0	Q2
TLV75512PDQNT	X2SON	DQN	4	250	180.0	8.4	1.16	1.16	0.63	4.0	8.0	Q2
TLV75512PDQNT	X2SON	DQN	4	250	180.0	9.5	1.16	1.16	0.5	4.0	8.0	Q2
TLV75512PDRVR	WSON	DRV	6	3000	180.0	8.4	2.3	2.3	1.15	4.0	8.0	Q2
TLV75512PDYDR	SOT-23	DYD	5	3000	180.0	8.4	3.2	3.2	1.4	4.0	8.0	Q3
TLV75515PDBVR	SOT-23	DBV	5	3000	180.0	8.4	3.2	3.2	1.4	4.0	8.0	Q3
TLV75515PDBVR	SOT-23	DBV	5	3000	180.0	8.4	3.2	3.2	1.4	4.0	8.0	Q3
TLV75515PDQNR	X2SON	DQN	4	3000	180.0	8.4	1.16	1.16	0.5	4.0	8.0	Q2
TLV75515PDQNT	X2SON	DQN	4	250	180.0	9.5	1.16	1.16	0.5	4.0	8.0	Q2
TLV75515PDQNT	X2SON	DQN	4	250	180.0	8.4	1.16	1.16	0.63	4.0	8.0	Q2
TLV75515PDQNT	X2SON	DQN	4	250	180.0	8.4	1.16	1.16	0.5	4.0	8.0	Q2
TLV75515PDRVR	WSON	DRV	6	3000	180.0	8.4	2.3	2.3	1.15	4.0	8.0	Q2
TLV755185PDQNR	X2SON	DQN	4	3000	180.0	9.5	1.16	1.16	0.5	4.0	8.0	Q2
TLV755185PDQNRM3	X2SON	DQN	4	3000	180.0	8.4	1.16	1.16	0.5	4.0	8.0	Q2
TLV75518PDBVR	SOT-23	DBV	5	3000	178.0	8.4	3.2	3.2	1.4	4.0	8.0	Q3
TLV75518PDQNR	X2SON	DQN	4	3000	180.0	8.4	1.16	1.16	0.5	4.0	8.0	Q2
TLV75518PDQNRG4	X2SON	DQN	4	3000	180.0	8.4	1.16	1.16	0.5	4.0	8.0	Q2
TLV75518PDQNT	X2SON	DQN	4	250	180.0	9.5	1.16	1.16	0.5	4.0	8.0	Q2
TLV75518PDQNT	X2SON	DQN	4	250	180.0	8.4	1.16	1.16	0.5	4.0	8.0	Q2
TLV75518PDQNT	X2SON	DQN	4	250	180.0	8.4	1.16	1.16	0.63	4.0	8.0	Q2
TLV75518PDRVR	WSON	DRV	6	3000	180.0	8.4	2.3	2.3	1.15	4.0	8.0	Q2
TLV75518PDYDR	SOT-23	DYD	5	3000	180.0	8.4	3.2	3.2	1.4	4.0	8.0	Q3
TLV75519PDBVR	SOT-23	DBV	5	3000	180.0	8.4	3.2	3.2	1.4	4.0	8.0	Q3
TLV75519PDBVR	SOT-23	DBV	5	3000	180.0	8.4	3.2	3.2	1.4	4.0	8.0	Q3
TLV75519PDQNR	X2SON	DQN	4	3000	180.0	8.4	1.16	1.16	0.5	4.0	8.0	Q2
TLV75519PDQNRG4	X2SON	DQN	4	3000	180.0	8.4	1.16	1.16	0.5	4.0	8.0	Q2
TLV75519PDQNT	X2SON	DQN	4	250	180.0	8.4	1.16	1.16	0.63	4.0	8.0	Q2
TLV75519PDQNT	X2SON	DQN	4	250	180.0	9.5	1.16	1.16	0.5	4.0	8.0	Q2
TLV75519PDQNT	X2SON	DQN	4	250	180.0	8.4	1.16	1.16	0.5	4.0	8.0	Q2
TLV75519PDRVR	WSON	DRV	6	3000	180.0	8.4	2.3	2.3	1.15	4.0	8.0	Q2
TLV75525PDBVR	SOT-23	DBV	5	3000	178.0	8.4	3.2	3.2	1.4	4.0	8.0	Q3
TLV75525PDQNR	X2SON	DQN	4	3000	180.0	8.4	1.16	1.16	0.5	4.0	8.0	Q2
TLV75525PDQNT	X2SON	DQN	4	250	180.0	8.4	1.16	1.16	0.63	4.0	8.0	Q2

Device	Package Type	Package Drawing	Pins	SPQ	Reel Diameter (mm)	Reel Width W1 (mm)	A0 (mm)	B0 (mm)	K0 (mm)	P1 (mm)	W (mm)	Pin1 Quadrant
TLV75525PDQNT	X2SON	DQN	4	250	180.0	9.5	1.16	1.16	0.5	4.0	8.0	Q2
TLV75525PDQNT	X2SON	DQN	4	250	180.0	8.4	1.16	1.16	0.5	4.0	8.0	Q2
TLV75525PDRVR	WSON	DRV	6	3000	180.0	8.4	2.3	2.3	1.15	4.0	8.0	Q2
TLV75525PDRVRG4	WSON	DRV	6	3000	180.0	8.4	2.3	2.3	1.15	4.0	8.0	Q2
TLV75525PDYDR	SOT-23	DYD	5	3000	180.0	8.4	3.2	3.2	1.4	4.0	8.0	Q3
TLV75528PDBVR	SOT-23	DBV	5	3000	180.0	8.4	3.2	3.2	1.4	4.0	8.0	Q3
TLV75528PDBVR	SOT-23	DBV	5	3000	180.0	8.4	3.2	3.2	1.4	4.0	8.0	Q3
TLV75528PDQNR	X2SON	DQN	4	3000	180.0	8.4	1.16	1.16	0.5	4.0	8.0	Q2
TLV75528PDQNT	X2SON	DQN	4	250	180.0	8.4	1.16	1.16	0.63	4.0	8.0	Q2
TLV75528PDQNT	X2SON	DQN	4	250	180.0	8.4	1.16	1.16	0.5	4.0	8.0	Q2
TLV75528PDQNT	X2SON	DQN	4	250	180.0	9.5	1.16	1.16	0.5	4.0	8.0	Q2
TLV75528PDRVR	WSON	DRV	6	3000	180.0	8.4	2.3	2.3	1.15	4.0	8.0	Q2
TLV75528PDYDR	SOT-23	DYD	5	3000	180.0	8.4	3.2	3.2	1.4	4.0	8.0	Q3
TLV75529PDBVR	SOT-23	DBV	5	3000	178.0	8.4	3.2	3.2	1.4	4.0	8.0	Q3
TLV75529PDRVR	WSON	DRV	6	3000	180.0	8.4	2.3	2.3	1.15	4.0	8.0	Q2
TLV75530PDBVR	SOT-23	DBV	5	3000	180.0	8.4	3.2	3.2	1.4	4.0	8.0	Q3
TLV75530PDBVR	SOT-23	DBV	5	3000	180.0	8.4	3.2	3.2	1.4	4.0	8.0	Q3
TLV75530PDQNR	X2SON	DQN	4	3000	180.0	8.4	1.16	1.16	0.5	4.0	8.0	Q2
TLV75530PDQNT	X2SON	DQN	4	250	180.0	8.4	1.16	1.16	0.5	4.0	8.0	Q2
TLV75530PDQNT	X2SON	DQN	4	250	180.0	8.4	1.16	1.16	0.63	4.0	8.0	Q2
TLV75530PDQNT	X2SON	DQN	4	250	180.0	9.5	1.16	1.16	0.5	4.0	8.0	Q2
TLV75530PDQNTG4	X2SON	DQN	4	250	180.0	8.4	1.16	1.16	0.5	4.0	8.0	Q2
TLV75530PDRVR	WSON	DRV	6	3000	180.0	8.4	2.3	2.3	1.15	4.0	8.0	Q2
TLV75532PDQNR	X2SON	DQN	4	3000	180.0	8.4	1.16	1.16	0.5	4.0	8.0	Q2
TLV75533PDBVR	SOT-23	DBV	5	3000	178.0	8.4	3.2	3.2	1.4	4.0	8.0	Q3
TLV75533PDQNR	X2SON	DQN	4	3000	180.0	9.5	1.16	1.16	0.5	4.0	8.0	Q2
TLV75533PDQNRG4	X2SON	DQN	4	3000	180.0	9.5	1.16	1.16	0.5	4.0	8.0	Q2
TLV75533PDQNRM3	X2SON	DQN	4	3000	180.0	8.4	1.16	1.16	0.5	4.0	8.0	Q2
TLV75533PDQNT	X2SON	DQN	4	250	180.0	9.5	1.16	1.16	0.5	4.0	8.0	Q2
TLV75533PDQNT	X2SON	DQN	4	250	180.0	8.4	1.16	1.16	0.63	4.0	8.0	Q2
TLV75533PDRVR	WSON	DRV	6	3000	180.0	8.4	2.3	2.3	1.15	4.0	8.0	Q2
TLV75533PDRVRG4	WSON	DRV	6	3000	180.0	8.4	2.3	2.3	1.15	4.0	8.0	Q2
TLV75533PDYDR	SOT-23	DYD	5	3000	180.0	8.4	3.2	3.2	1.4	4.0	8.0	Q3
TLV755345PDQNR	X2SON	DQN	4	3000	180.0	8.4	1.16	1.16	0.5	4.0	8.0	Q2

**TAPE AND REEL BOX DIMENSIONS**

\*All dimensions are nominal

Device	Package Type	Package Drawing	Pins	SPQ	Length (mm)	Width (mm)	Height (mm)
TLV755075PDQNR	X2SON	DQN	4	3000	210.0	185.0	35.0
TLV75507PDQNR	X2SON	DQN	4	3000	210.0	185.0	35.0
TLV75507PDQNT	X2SON	DQN	4	250	210.0	185.0	35.0
TLV75509PDBVR	SOT-23	DBV	5	3000	208.0	191.0	35.0
TLV75509PDQNR	X2SON	DQN	4	3000	210.0	185.0	35.0
TLV75509PDQNT	X2SON	DQN	4	250	210.0	185.0	35.0
TLV75509PDQNT	X2SON	DQN	4	250	184.0	184.0	19.0
TLV75509PDQNT	X2SON	DQN	4	250	183.0	183.0	20.0
TLV75509PDRVR	WSON	DRV	6	3000	210.0	185.0	35.0
TLV75509PDYDR	SOT-23	DYD	5	3000	210.0	185.0	35.0
TLV75510PDBVR	SOT-23	DBV	5	3000	210.0	185.0	35.0
TLV75510PDBVR	SOT-23	DBV	5	3000	210.0	185.0	35.0
TLV75510PDBVRG4	SOT-23	DBV	5	3000	210.0	185.0	35.0
TLV75510PDQNR	X2SON	DQN	4	3000	183.0	183.0	20.0
TLV75510PDQNR	X2SON	DQN	4	3000	184.0	184.0	19.0
TLV75510PDQNRM3	X2SON	DQN	4	3000	210.0	185.0	35.0
TLV75510PDQNT	X2SON	DQN	4	250	183.0	183.0	20.0
TLV75510PDQNT	X2SON	DQN	4	250	184.0	184.0	19.0

Device	Package Type	Package Drawing	Pins	SPQ	Length (mm)	Width (mm)	Height (mm)
TLV75510PDRVR	WSON	DRV	6	3000	210.0	185.0	35.0
TLV75510PDRVRG4	WSON	DRV	6	3000	210.0	185.0	35.0
TLV75511PDQNR	X2SON	DQN	4	3000	210.0	185.0	35.0
TLV75512PDBVR	SOT-23	DBV	5	3000	208.0	191.0	35.0
TLV75512PDBVRG4	SOT-23	DBV	5	3000	210.0	185.0	35.0
TLV75512PDQNR	X2SON	DQN	4	3000	184.0	184.0	19.0
TLV75512PDQNRM3	X2SON	DQN	4	3000	210.0	185.0	35.0
TLV75512PDQNT	X2SON	DQN	4	250	183.0	183.0	20.0
TLV75512PDQNT	X2SON	DQN	4	250	184.0	184.0	19.0
TLV75512PDRVR	WSON	DRV	6	3000	210.0	185.0	35.0
TLV75512PDYDR	SOT-23	DYD	5	3000	210.0	185.0	35.0
TLV75515PDBVR	SOT-23	DBV	5	3000	210.0	185.0	35.0
TLV75515PDBVR	SOT-23	DBV	5	3000	210.0	185.0	35.0
TLV75515PDQNR	X2SON	DQN	4	3000	210.0	185.0	35.0
TLV75515PDQNT	X2SON	DQN	4	250	184.0	184.0	19.0
TLV75515PDQNT	X2SON	DQN	4	250	183.0	183.0	20.0
TLV75515PDQNT	X2SON	DQN	4	250	210.0	185.0	35.0
TLV75515PDRVR	WSON	DRV	6	3000	210.0	185.0	35.0
TLV755185PDQNR	X2SON	DQN	4	3000	184.0	184.0	19.0
TLV755185PDQNRM3	X2SON	DQN	4	3000	210.0	185.0	35.0
TLV75518PDBVR	SOT-23	DBV	5	3000	208.0	191.0	35.0
TLV75518PDQNR	X2SON	DQN	4	3000	210.0	185.0	35.0
TLV75518PDQNRG4	X2SON	DQN	4	3000	210.0	185.0	35.0
TLV75518PDQNT	X2SON	DQN	4	250	184.0	184.0	19.0
TLV75518PDQNT	X2SON	DQN	4	250	210.0	185.0	35.0
TLV75518PDQNT	X2SON	DQN	4	250	183.0	183.0	20.0
TLV75518PDRVR	WSON	DRV	6	3000	210.0	185.0	35.0
TLV75518PDYDR	SOT-23	DYD	5	3000	210.0	185.0	35.0
TLV75519PDBVR	SOT-23	DBV	5	3000	210.0	185.0	35.0
TLV75519PDBVR	SOT-23	DBV	5	3000	210.0	185.0	35.0
TLV75519PDQNR	X2SON	DQN	4	3000	210.0	185.0	35.0
TLV75519PDQNRG4	X2SON	DQN	4	3000	210.0	185.0	35.0
TLV75519PDQNT	X2SON	DQN	4	250	183.0	183.0	20.0
TLV75519PDQNT	X2SON	DQN	4	250	184.0	184.0	19.0
TLV75519PDQNT	X2SON	DQN	4	250	210.0	185.0	35.0
TLV75519PDRVR	WSON	DRV	6	3000	210.0	185.0	35.0
TLV75525PDBVR	SOT-23	DBV	5	3000	208.0	191.0	35.0
TLV75525PDQNR	X2SON	DQN	4	3000	210.0	185.0	35.0
TLV75525PDQNT	X2SON	DQN	4	250	183.0	183.0	20.0
TLV75525PDQNT	X2SON	DQN	4	250	184.0	184.0	19.0
TLV75525PDQNT	X2SON	DQN	4	250	210.0	185.0	35.0
TLV75525PDRVR	WSON	DRV	6	3000	210.0	185.0	35.0
TLV75525PDRVRG4	WSON	DRV	6	3000	210.0	185.0	35.0

Device	Package Type	Package Drawing	Pins	SPQ	Length (mm)	Width (mm)	Height (mm)
TLV75525PDYDR	SOT-23	DYD	5	3000	210.0	185.0	35.0
TLV75528PDBVR	SOT-23	DBV	5	3000	210.0	185.0	35.0
TLV75528PDBVR	SOT-23	DBV	5	3000	210.0	185.0	35.0
TLV75528PDQNR	X2SON	DQN	4	3000	210.0	185.0	35.0
TLV75528PDQNT	X2SON	DQN	4	250	183.0	183.0	20.0
TLV75528PDQNT	X2SON	DQN	4	250	210.0	185.0	35.0
TLV75528PDQNT	X2SON	DQN	4	250	184.0	184.0	19.0
TLV75528PDRVR	WSON	DRV	6	3000	210.0	185.0	35.0
TLV75528PDYDR	SOT-23	DYD	5	3000	210.0	185.0	35.0
TLV75529PDBVR	SOT-23	DBV	5	3000	208.0	191.0	35.0
TLV75529PDRVR	WSON	DRV	6	3000	210.0	185.0	35.0
TLV75530PDBVR	SOT-23	DBV	5	3000	210.0	185.0	35.0
TLV75530PDBVR	SOT-23	DBV	5	3000	210.0	185.0	35.0
TLV75530PDQNR	X2SON	DQN	4	3000	210.0	185.0	35.0
TLV75530PDQNT	X2SON	DQN	4	250	210.0	185.0	35.0
TLV75530PDQNT	X2SON	DQN	4	250	183.0	183.0	20.0
TLV75530PDQNT	X2SON	DQN	4	250	184.0	184.0	19.0
TLV75530PDQNTG4	X2SON	DQN	4	250	210.0	185.0	35.0
TLV75530PDRVR	WSON	DRV	6	3000	210.0	185.0	35.0
TLV75532PDQNR	X2SON	DQN	4	3000	210.0	185.0	35.0
TLV75533PDBVR	SOT-23	DBV	5	3000	208.0	191.0	35.0
TLV75533PDQNR	X2SON	DQN	4	3000	184.0	184.0	19.0
TLV75533PDQNRG4	X2SON	DQN	4	3000	184.0	184.0	19.0
TLV75533PDQNRM3	X2SON	DQN	4	3000	210.0	185.0	35.0
TLV75533PDQNT	X2SON	DQN	4	250	184.0	184.0	19.0
TLV75533PDQNT	X2SON	DQN	4	250	183.0	183.0	20.0
TLV75533PDRVR	WSON	DRV	6	3000	210.0	185.0	35.0
TLV75533PDRVRG4	WSON	DRV	6	3000	210.0	185.0	35.0
TLV75533PDYDR	SOT-23	DYD	5	3000	210.0	185.0	35.0
TLV755345PDQNR	X2SON	DQN	4	3000	210.0	185.0	35.0

## GENERIC PACKAGE VIEW

DQN 4

**X2SON - 0.4 mm max height**

PLASTIC SMALL OUTLINE - NO LEAD



Images above are just a representation of the package family, actual package may vary.  
Refer to the product data sheet for package details.

4210367/F

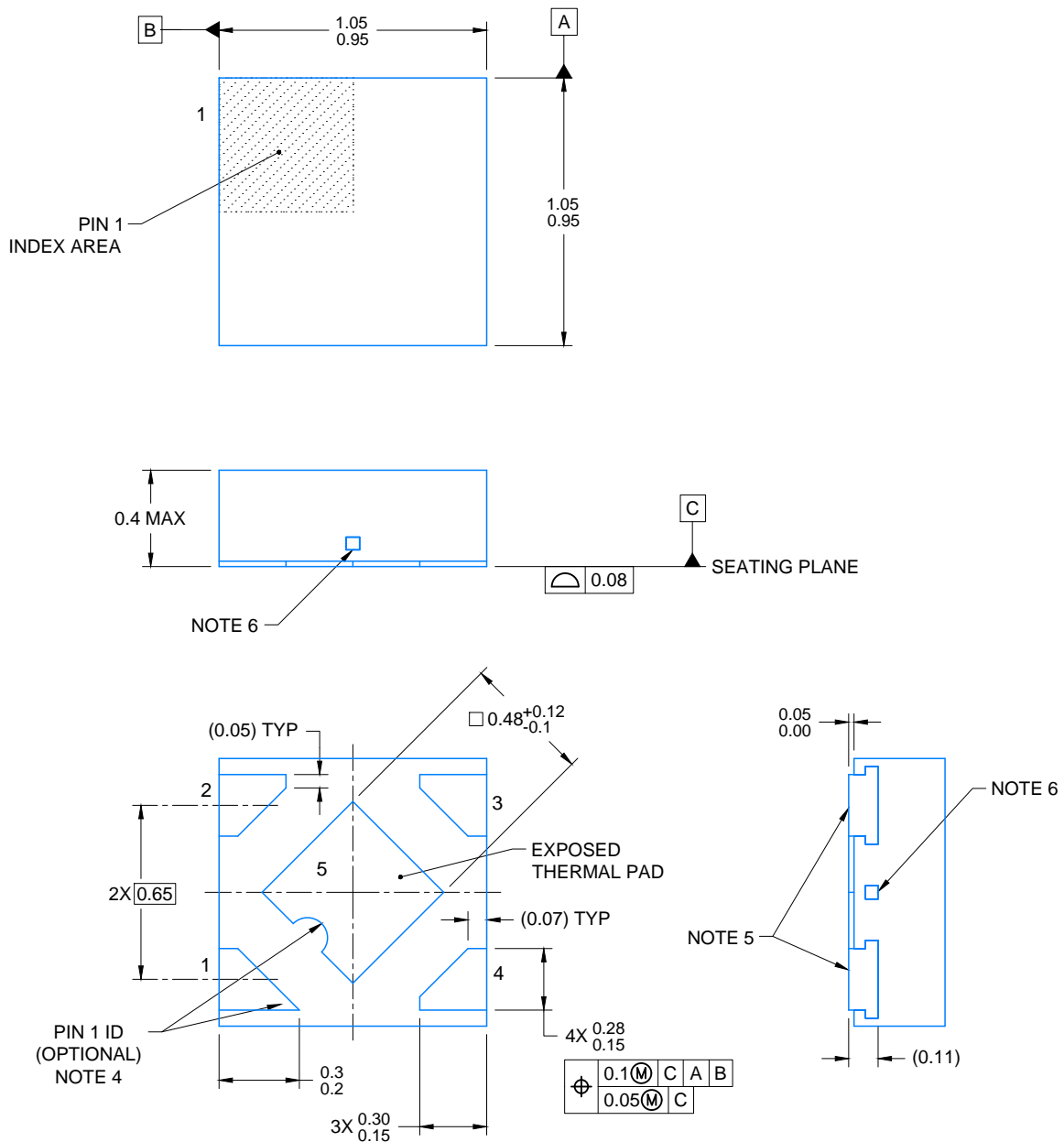

4215302/E 12/2016

NOTES:

1. All linear dimensions are in millimeters. Any dimensions in parenthesis are for reference only. Dimensioning and tolerancing per ASME Y14.5M.
2. This drawing is subject to change without notice.
3. The package thermal pad must be soldered to the printed circuit board for optimal thermal and mechanical performance.
4. Features may not exist. Recommend use of pin 1 marking on top of package for orientation purposes.
5. Shape of exposed side leads may differ.
6. Number and location of exposed tie bars may vary.

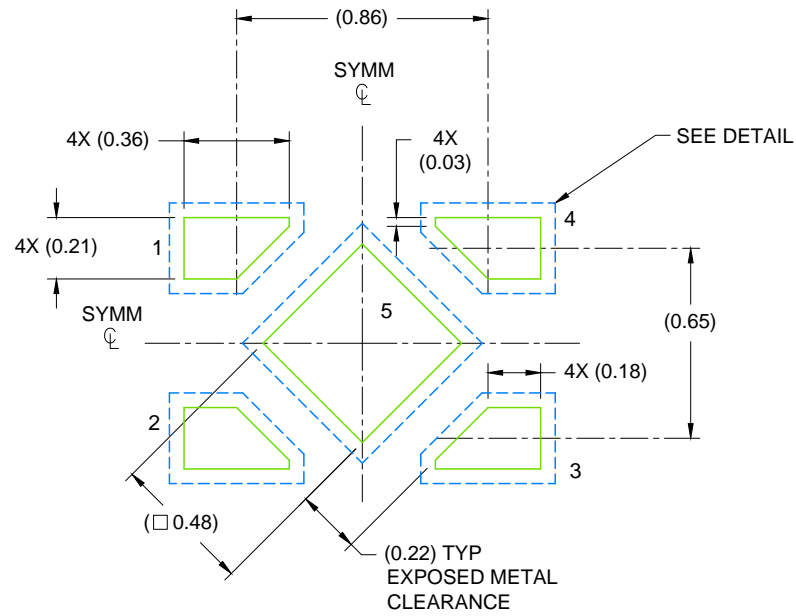

LAND PATTERN EXAMPLE  
SCALE: 40X

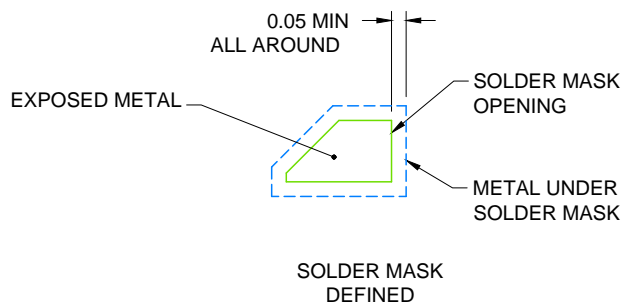

SOLDER MASK DETAIL

4215302/E 12/2016

NOTES: (continued)

7. This package is designed to be soldered to a thermal pad on the board. For more information, see Texas Instruments literature number SLUA271 ([www.ti.com/lit/sluea271](http://www.ti.com/lit/sluea271)).
8. If any vias are implemented, it is recommended that vias under paste be filled, plugged or tented.



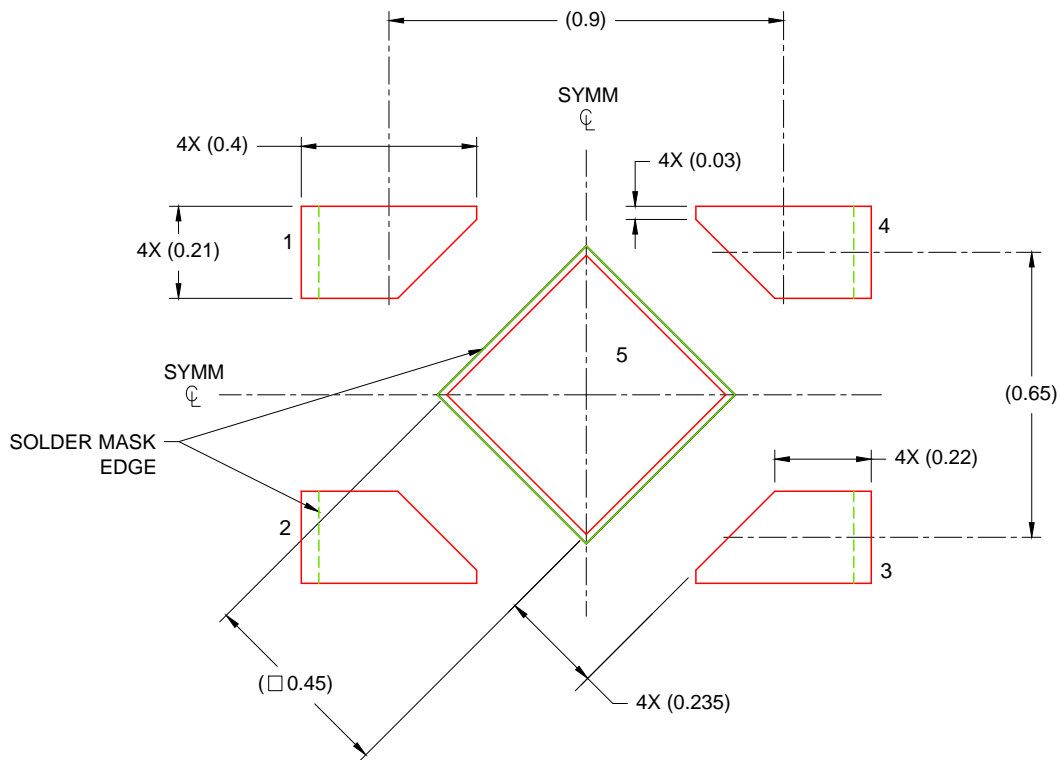

SOLDER PASTE EXAMPLE  
 BASED ON 0.075 - 0.1mm THICK STENCIL  
 EXPOSED PAD  
 88% PRINTED SOLDER COVERAGE BY AREA  
 SCALE: 60X

4215302/E 12/2016

NOTES: (continued)

- 9. Laser cutting apertures with trapezoidal walls and rounded corners may offer better paste release. IPC-7525 may have alternate design recommendations.



# EXAMPLE BOARD LAYOUT

DBV0005A

SOT-23 - 1.45 mm max height

SMALL OUTLINE TRANSISTOR

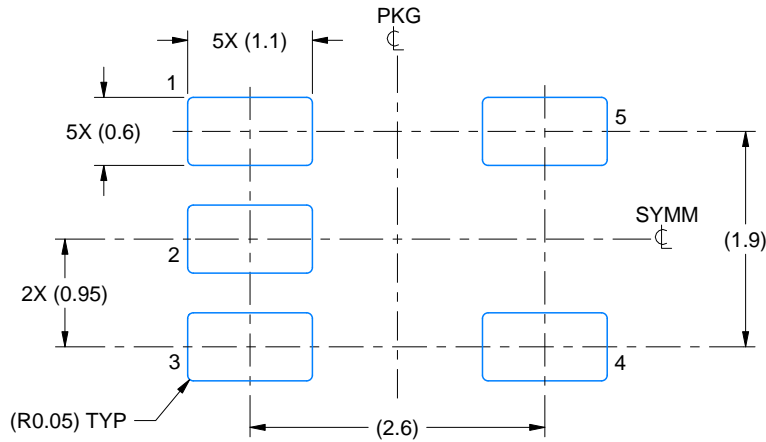

LAND PATTERN EXAMPLE  
EXPOSED METAL SHOWN  
SCALE:15X



SOLDER MASK DETAILS

4214839/K 08/2024

NOTES: (continued)

- 6. Publication IPC-7351 may have alternate designs.
- 7. Solder mask tolerances between and around signal pads can vary based on board fabrication site.

# EXAMPLE STENCIL DESIGN

DBV0005A

SOT-23 - 1.45 mm max height

SMALL OUTLINE TRANSISTOR



SOLDER PASTE EXAMPLE  
BASED ON 0.125 mm THICK STENCIL  
SCALE:15X

4214839/K 08/2024

NOTES: (continued)

8. Laser cutting apertures with trapezoidal walls and rounded corners may offer better paste release. IPC-7525 may have alternate design recommendations.
9. Board assembly site may have different recommendations for stencil design.

## GENERIC PACKAGE VIEW

DRV 6

WSON - 0.8 mm max height

PLASTIC SMALL OUTLINE - NO LEAD

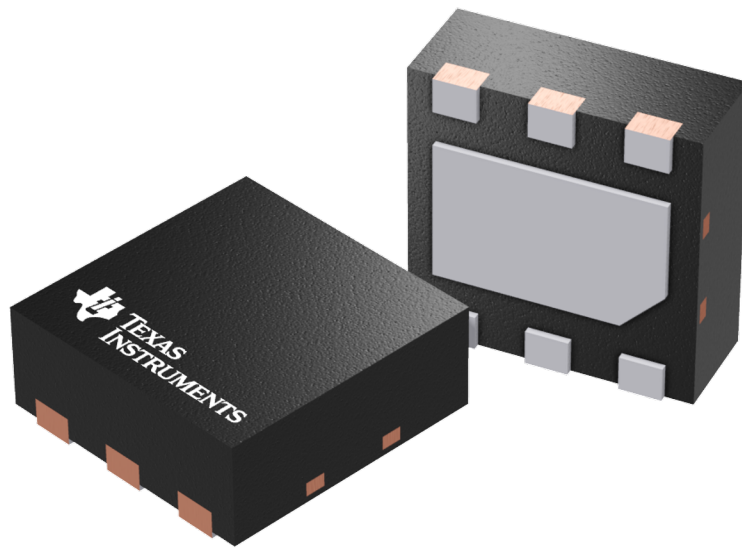

Images above are just a representation of the package family, actual package may vary.  
Refer to the product data sheet for package details.

4206925/F

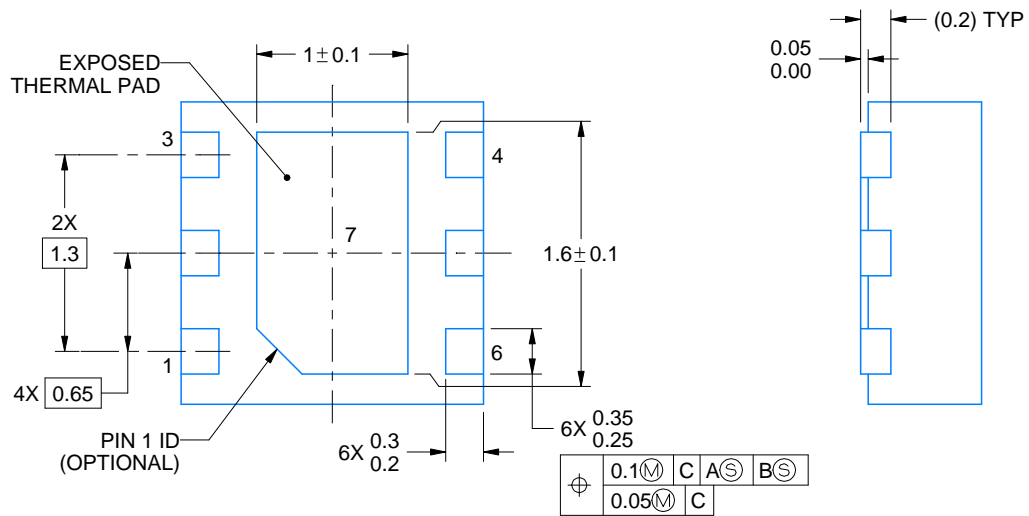
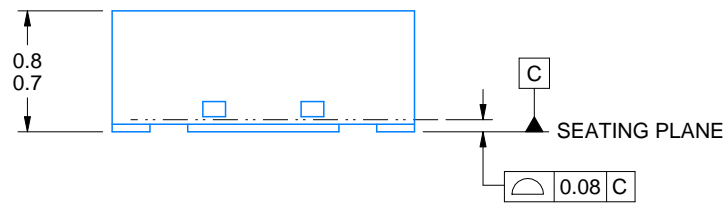
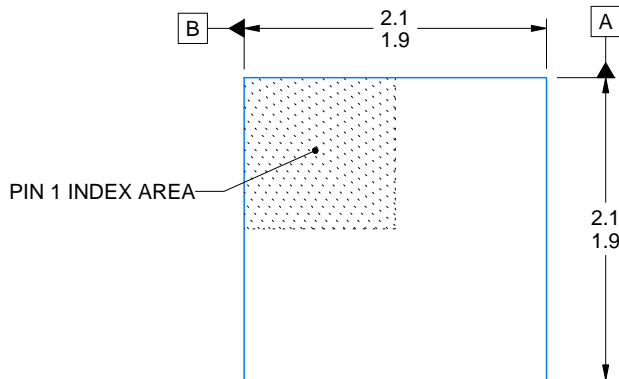
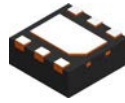

4222173/B 04/2018

NOTES:

1. All linear dimensions are in millimeters. Any dimensions in parenthesis are for reference only. Dimensioning and tolerancing per ASME Y14.5M.
2. This drawing is subject to change without notice.
3. The package thermal pad must be soldered to the printed circuit board for thermal and mechanical performance.

# EXAMPLE BOARD LAYOUT

DRV0006A

WSON - 0.8 mm max height

PLASTIC SMALL OUTLINE - NO LEAD

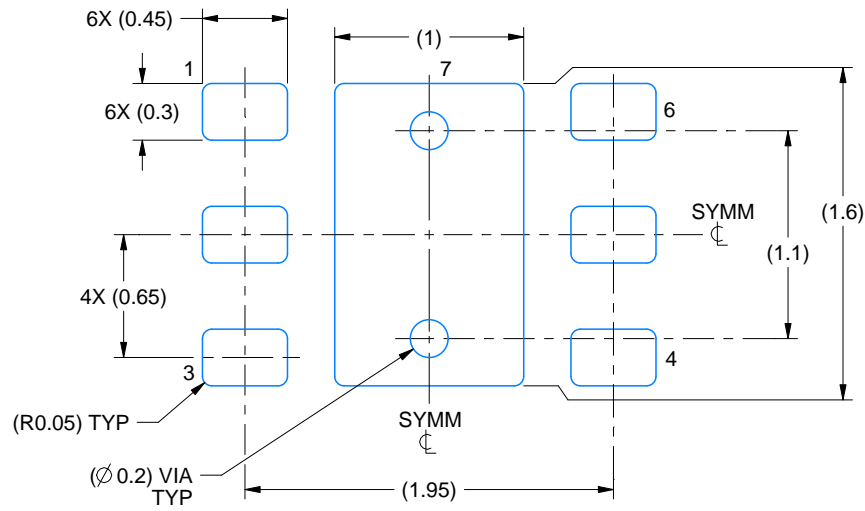

LAND PATTERN EXAMPLE  
SCALE:25X

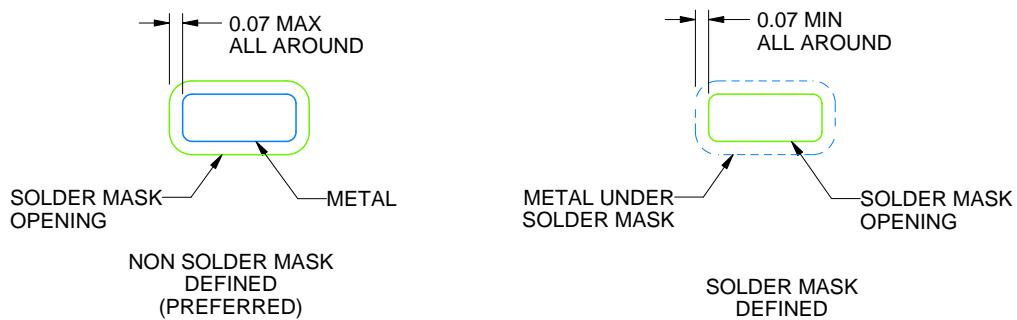

SOLDER MASK DETAILS

4222173/B 04/2018

NOTES: (continued)

4. This package is designed to be soldered to a thermal pad on the board. For more information, see Texas Instruments literature number SLUA271 ([www.ti.com/lit/slue271](http://www.ti.com/lit/slue271)).
5. Vias are optional depending on application, refer to device data sheet. If some or all are implemented, recommended via locations are shown.

# EXAMPLE STENCIL DESIGN

DRV0006A

WSON - 0.8 mm max height

PLASTIC SMALL OUTLINE - NO LEAD

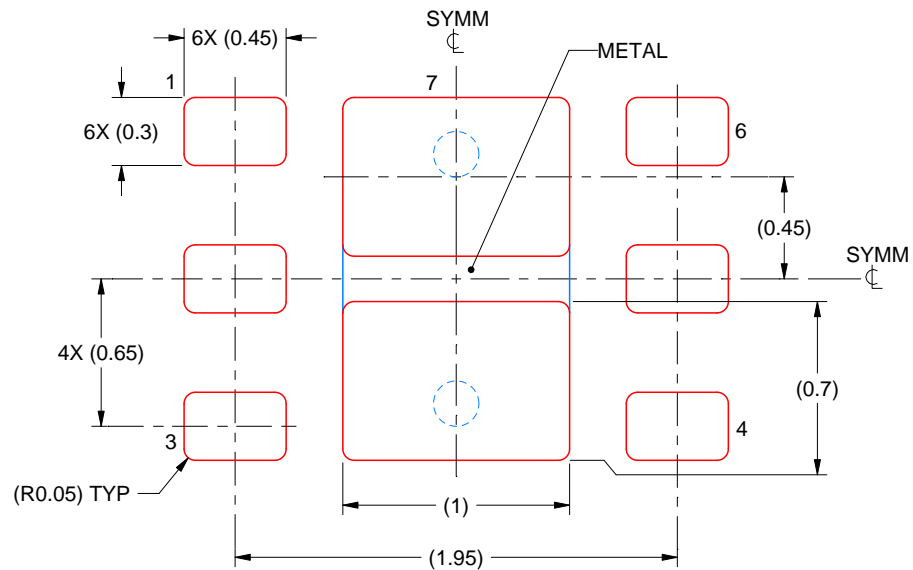

SOLDER PASTE EXAMPLE  
BASED ON 0.125 mm THICK STENCIL

EXPOSED PAD #7  
88% PRINTED SOLDER COVERAGE BY AREA UNDER PACKAGE  
SCALE:30X

4222173/B 04/2018

NOTES: (continued)

6. Laser cutting apertures with trapezoidal walls and rounded corners may offer better paste release. IPC-7525 may have alternate design recommendations.



# DYD0005A



# PACKAGE OUTLINE

SOT-23 - 1.45 mm max height

SMALL OUTLINE TRANSISTOR

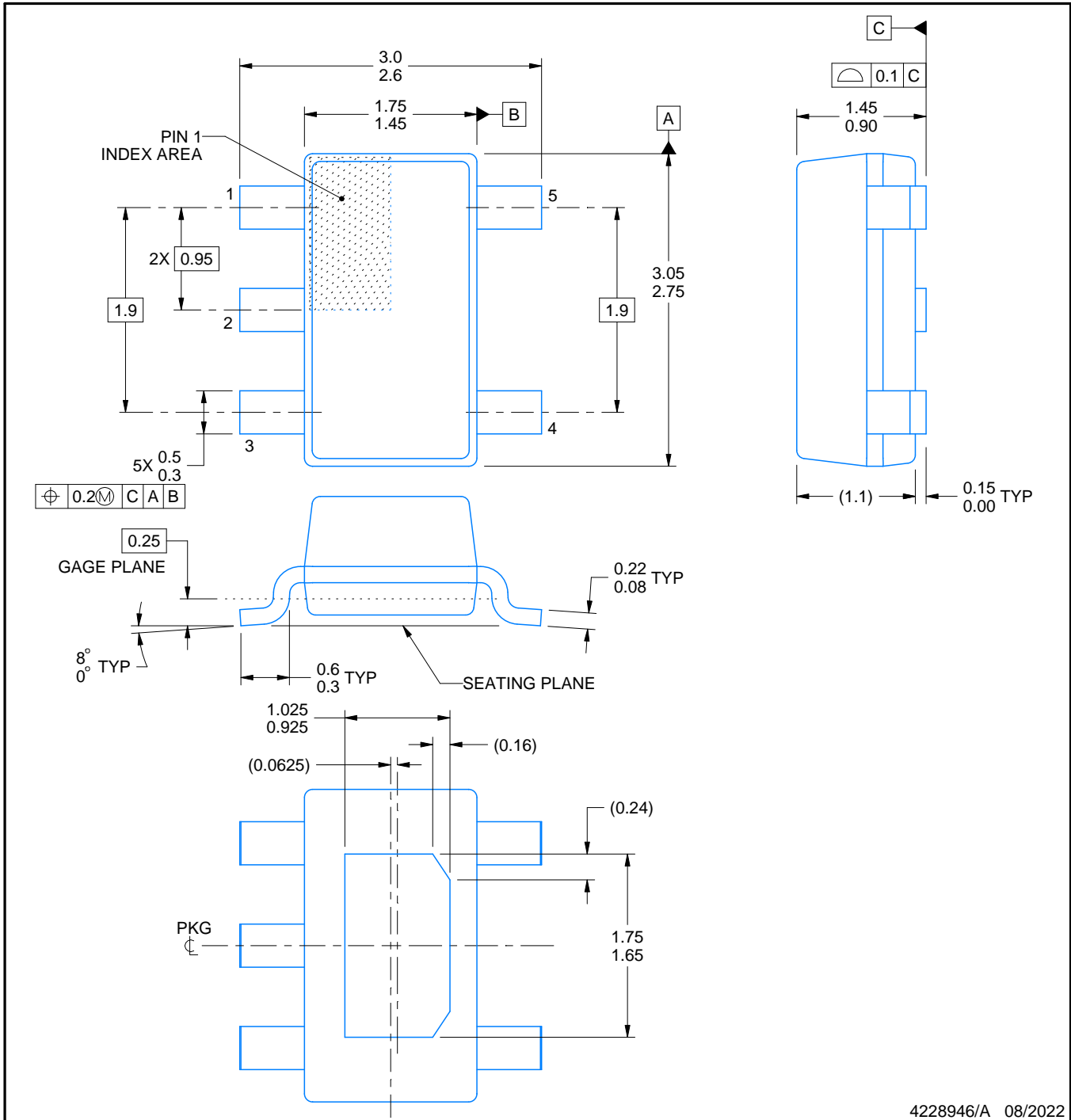

4228946/A 08/2022

**NOTES:**

1. All linear dimensions are in millimeters. Any dimensions in parenthesis are for reference only. Dimensioning and tolerancing per ASME Y14.5M.
2. This drawing is subject to change without notice.
3. Reference JEDEC MO-178.
4. Body dimensions do not include mold flash, protrusions, or gate burrs. Mold flash, protrusions, or gate burrs shall not exceed 0.25 mm per side.

# EXAMPLE BOARD LAYOUT

DYD0005A

SOT-23 - 1.45 mm max height

SMALL OUTLINE TRANSISTOR

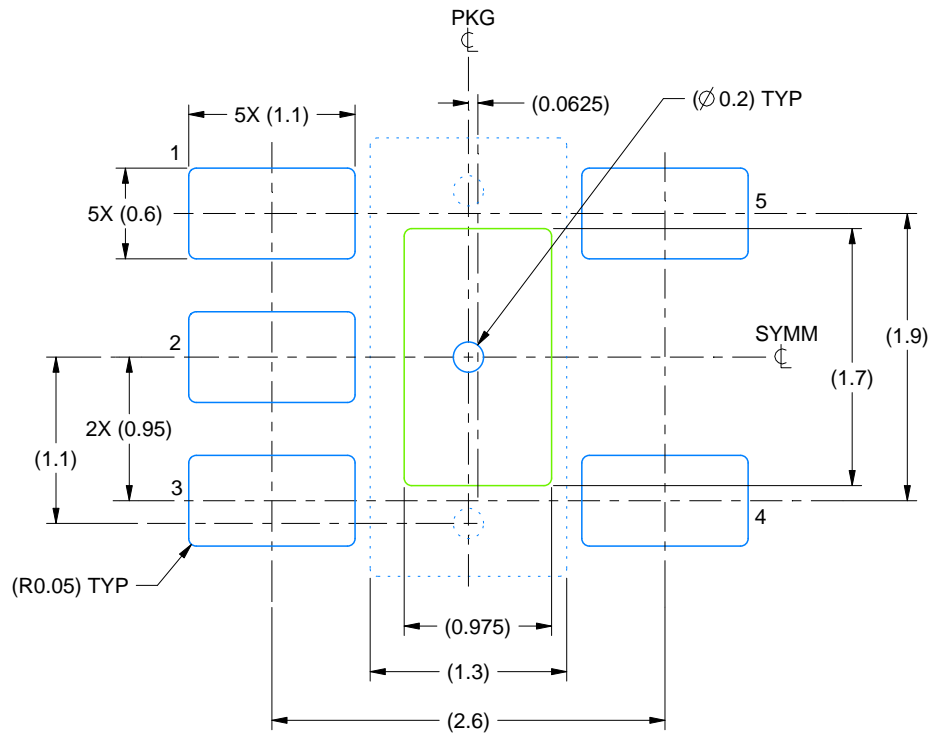

LAND PATTERN EXAMPLE  
EXPOSED METAL SHOWN  
SCALE:20X

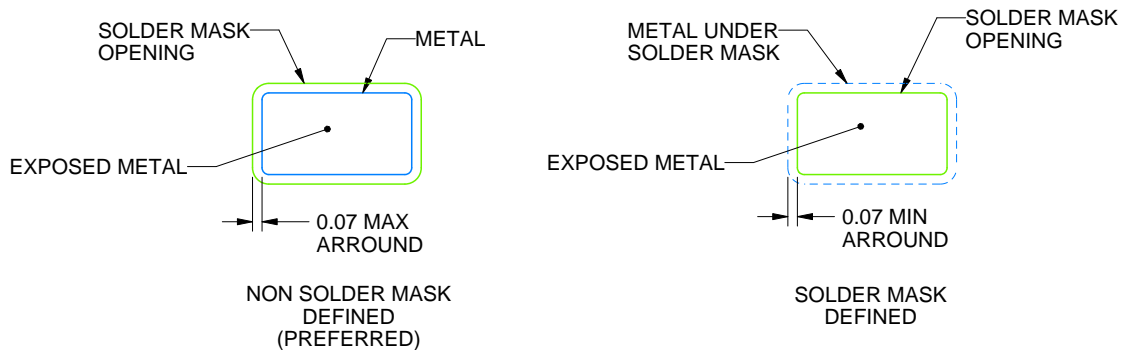

SOLDER MASK DETAILS

4228946/A 08/2022

NOTES: (continued)

- 5. Publication IPC-7351 may have alternate designs.
- 6. Solder mask tolerances between and around signal pads can vary based on board fabrication site.

# EXAMPLE STENCIL DESIGN

DYD0005A

SOT-23 - 1.45 mm max height

SMALL OUTLINE TRANSISTOR

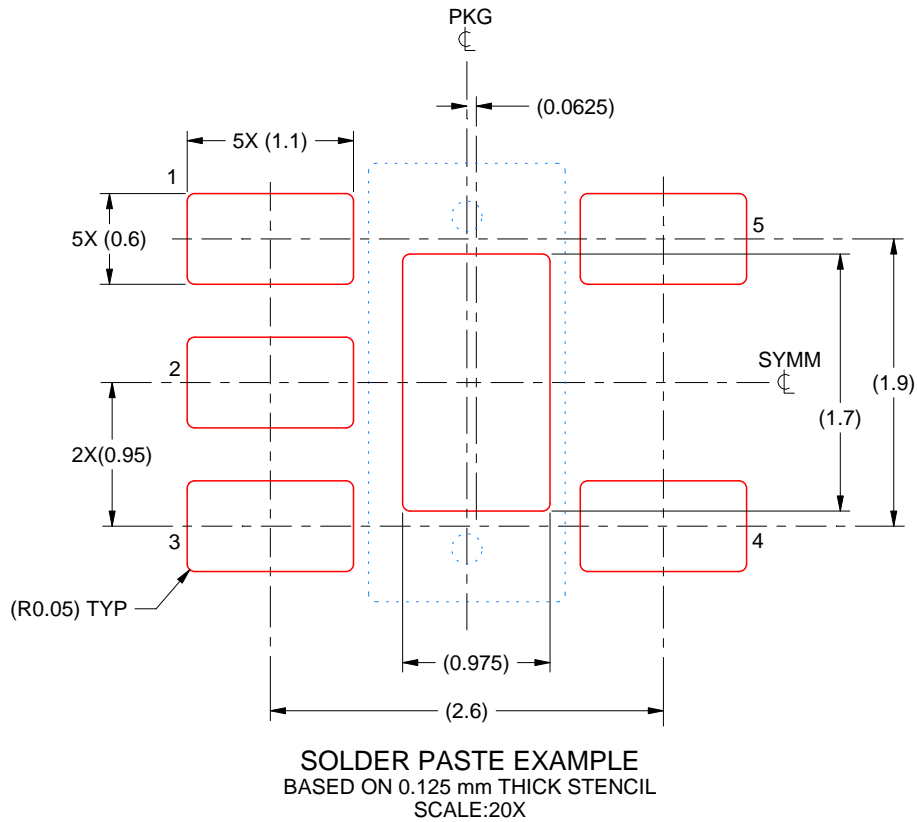

STENCIL THICKNESS	SOLDER STENCIL OPENING
0.100	1.09 X 1.90
0.125	0.975 X 1.700 (SHOWN)
0.150	0.89 X 1.55
0.175	0.82 X 1.44

4228946/A 08/2022

NOTES: (continued)

7. Laser cutting apertures with trapezoidal walls and rounded corners may offer better paste release. IPC-7525 may have alternate design recommendations.
8. Board assembly site may have different recommendations for stencil design.

## 重要なお知らせと免責事項

TI は、技術データと信頼性データ(データシートを含みます)、設計リソース(リファレンス デザインを含みます)、アプリケーションや設計に関する各種アドバイス、Web ツール、安全性情報、その他のリソースを、欠陥が存在する可能性のある「現状のまま」提供しており、商品性および特定目的に対する適合性の黙示保証、第三者の知的財産権の非侵害保証を含むいかなる保証も、明示的または黙示的にかかわらず拒否します。

これらのリソースは、TI 製品を使用する設計の経験を積んだ開発者への提供を意図したものです。(1) お客様のアプリケーションに適した TI 製品の選定、(2) お客様のアプリケーションの設計、検証、試験、(3) お客様のアプリケーションに該当する各種規格や、その他のあらゆる安全性、セキュリティ、規制、または他の要件への確実な適合に関する責任を、お客様のみが単独で負うものとし、

上記の各種リソースは、予告なく変更される可能性があります。これらのリソースは、リソースで説明されている TI 製品を使用するアプリケーションの開発の目的でのみ、TI はその使用をお客様に許諾します。これらのリソースに関して、他の目的で複製することや掲載することは禁止されています。TI や第三者の知的財産権のライセンスが付与されている訳ではありません。お客様は、これらのリソースを自身で使用した結果発生するあらゆる申し立て、損害、費用、損失、責任について、TI およびその代理人を完全に補償するものとし、TI は一切の責任を拒否します。

TI の製品は、[TI の販売条件](#)、[TI の総合的な品質ガイドライン](#)、[ti.com](#) または TI 製品などに関連して提供される他の適用条件に従い提供されます。TI がこれらのリソースを提供することは、適用される TI の保証または他の保証の放棄の拡大や変更を意味するものではありません。TI がカスタム、またはカスタマー仕様として明示的に指定していない限り、TI の製品は標準的なカタログに掲載される汎用機器です。

お客様がいかなる追加条項または代替条項を提案する場合も、TI はそれらに異議を唱え、拒否します。

Copyright © 2025, Texas Instruments Incorporated

最終更新日 : 2025 年 10 月