

# TLV3011-Q1、TLV3012-Q1、TLV3011B-Q1、TLV3012B-Q1 1.24V 基準電圧内蔵低消費電力コンパレータ

## 1 特長

- 車載アプリケーション認定済み
- 以下の結果で AEC-Q100 認定済み:
  - デバイス温度グレード 1: 動作時周囲温度範囲  $-40^{\circ}\text{C} \sim +125^{\circ}\text{C}$
  - デバイス HBM ESD 分類レベル 2
  - デバイス CDM ESD 分類レベル C3
- 低い静止電流:  $3.1\mu\text{A}$  (最大値、「B」バージョン)
- 内蔵基準電圧:  $1.242\text{V}$
- 入力同相範囲: レールの  $200\text{mV}$  外まで
- 基準電圧の初期精度:  $1.5\%$
- 内蔵ヒステリシス機能:  $6\text{mV}$  (標準値)
- フェイルセーフ入力 (「B」バージョン)
- パワーオンリセット (「B」バージョン)
- オープンドレイン出力オプション (TLV3011x-Q1)
- プッシュプル出力オプション (TLV3012x-Q1)
- 迅速な応答時間:  $2\mu\text{S}$  (「B」バージョン)
- 低い電源電圧:  $1.65\text{V} \sim 5.5\text{V}$  (「B」バージョン)

## 2 アプリケーション

- 車線離脱警報
- クラスタ
- 有料道路支払い用タグ
- アセットトラッキング
- バッテリー管理システム

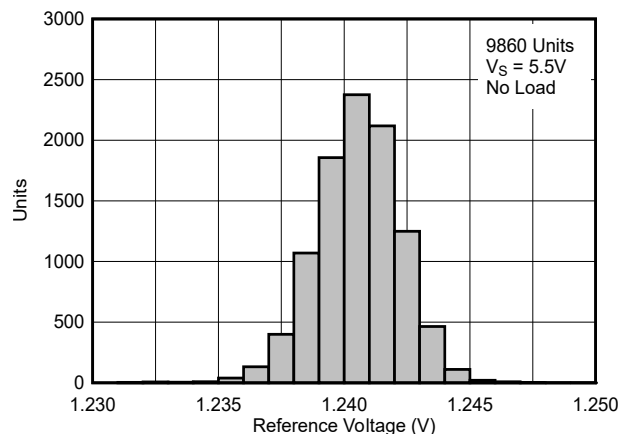

TLV3012B-Q1 の基準電圧の分布

## 3 概要

TLV3011-Q1 は低消費電力オープンドレイン出力のコンパレータです。TLV3012-Q1 はプッシュプル出力のコンパレータです。どちらのデバイスも、不確定なオンチップ基準電圧を採用しており、静止電流が  $5\mu\text{A}$  (最大値)、電源レールを上回る  $200\text{mV}$  入力同相範囲、 $1.8\text{V} \sim 5.5\text{V}$  の単一電源で動作します。内蔵  $1.242\text{V}$  シリーズ基準電圧は、 $100\text{ppm}/^{\circ}\text{C}$  (最大値) の低ドリフトを実現し、最大  $10\text{nF}$  の容量性負荷で安定しており、最大  $0.5\text{mA}$  (標準値) の出力電流を提供できます。

TLV3011B-Q1 および TLV3012B-Q1 の「B」バージョンには、パワー オンリセット (POR)、フェイルセーフ入力、最小電源電圧は  $1.65\text{V}$  と低く、最大静止電流は  $3.1\mu\text{A}$  です。

このファミリは、省スペース設計向けの超小型 SOT23-6 パッケージと、基板面積をさらに節約できる SC-70 パッケージで供給されます。どちらのバージョンも、動作温度範囲の仕様は  $-40^{\circ}\text{C} \sim +125^{\circ}\text{C}$  です。

### パッケージ情報

部品番号	パッケージ (1)	パッケージ サイズ (2)
TLV3011A-Q1、 TLV3012A-Q1、 TLV3011B-Q1、 TLV3012B-Q1	DBV (SOT-23, 6)	$2.9\text{mm} \times 2.8\text{mm}$
	DCK (SC-70, 6)	$2\text{mm} \times 2.1\text{mm}$

- (1) 利用可能なすべてのパッケージについては、データシートの末尾にある注文情報を参照してください。
- (2) パッケージサイズ (長さ × 幅) は公称値で、該当する場合はピンも含まれます。

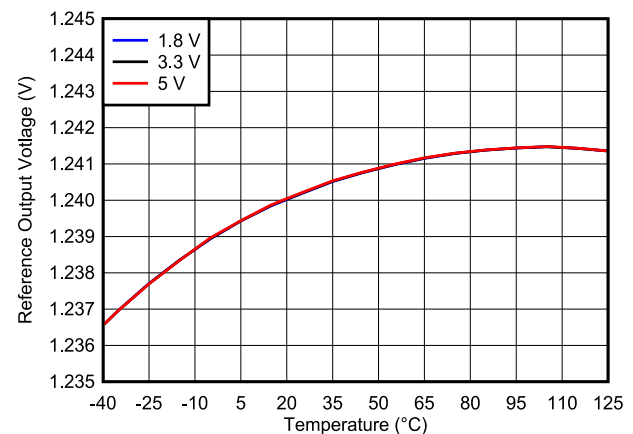

TLV3012B-Q1 の基準電圧と温度との関係



## Table of Contents

<b>1 特長</b> .....	1	7.4 Device Functional Modes.....	14
<b>2 アプリケーション</b> .....	1	<b>8 Application and Implementation</b> .....	16
<b>3 概要</b> .....	1	8.1 Application Information.....	16
<b>4 Pin Configuration and Functions</b> .....	3	8.2 Typical Application.....	17
<b>5 Specifications</b> .....	4	8.3 System Examples.....	19
5.1 Absolute Maximum Ratings.....	4	8.4 Power Supply Recommendations.....	21
5.2 ESD Ratings.....	4	8.5 Layout.....	21
5.3 Thermal Information.....	4	<b>9 Device and Documentation Support</b> .....	22
5.4 Recommended Operating Conditions.....	4	9.1 ドキュメントの更新通知を受け取る方法.....	22
5.5 Electrical Characteristics.....	5	9.2 サポート・リソース.....	22
5.6 Switching Characteristics.....	7	9.3 Trademarks.....	22
<b>6 Typical Characteristics</b> .....	8	9.4 静電気放電に関する注意事項.....	22
<b>7 Detailed Description</b> .....	14	9.5 用語集.....	22
7.1 Overview.....	14	<b>10 Revision History</b> .....	22
7.2 Functional Block Diagram.....	14	<b>11 Mechanical, Packaging, and Orderable Information</b> .....	23
7.3 Feature Description.....	14		

## 4 Pin Configuration and Functions

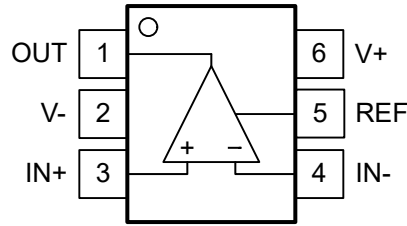

**図 4-1. DCK, DBV Package  
6-Pin SC-70, SOT-23  
Top View**

**表 4-1. Pin Functions**

PIN		I/O	DESCRIPTION
NO.	NAME		
1	OUT	O	Comparator Output
2	V-	-	Negative (lowest) power supply
3	IN+	I	Non-inverting comparator input
4	IN-	I	Inverting comparator input
5	REF	O	Reference Output
6	V+	-	Positive (highest) power supply

## 5 Specifications

### 5.1 Absolute Maximum Ratings

over operating free-air temperature range (unless otherwise noted)<sup>(1)</sup>

	MIN	MAX	UNIT
Supply voltage: $V_S = (V+) - (V-)$	-0.5	7	V
Input pins (IN+, IN-) from (V-) <sup>(2)</sup>	-0.5	7	V
Output (OUT) (Open-Drain) from (V-) <sup>(3)</sup>	-0.5	7	V
Output (OUT) (Push-Pull) from (V-)	-0.5	(V+) + 0.5	V
Output short circuit current <sup>(4)</sup>		10	mA
Junction temperature, $T_J$		150	°C
Storage temperature, $T_{stg}$	-65	150	°C

- (1) Operation outside the Absolute Maximum Ratings can cause permanent device damage. Absolute Maximum Ratings do not imply functional operation of the device at these or any other conditions beyond those listed under Recommended Operating Conditions. If used outside the Recommended Operating Conditions but within the Absolute Maximum Ratings, the device may not be fully functional, and this can affect device reliability, functionality, performance, and shorten the device lifetime.
- (2) Input pins are diode-clamped to (V-). Inputs (IN+, IN-) can be greater than (V+) as long as within the -0.5V to 7V range. Inputs beyond -0.3V must be current-limited to less than -10mA, while inputs beyond 7V must be externally voltage clamped.
- (3) Output (OUT) for open drain can be greater than (V+) and inputs (IN+, IN-) as long as the output is within the -0.5V to 7V range
- (4) Short-circuit to (V-) or (V+).

### 5.2 ESD Ratings

			VALUE	UNIT
$V_{(ESD)}$	Electrostatic discharge	Human-body model (HBM), per AEC Q100-002 <sup>(1)</sup>	±2000	V
		Charged-device model (CDM), per AEC Q100-0111	±1000	

- (1) AEC Q100-002 indicates that HBM stressing shall be in accordance with the ANSI/ESDA/JEDEC JS-001 specification.

### 5.3 Thermal Information

THERMAL METRIC <sup>(1)</sup>		DCK (SC-70)	DBV (SOT-23)	UNIT
		6 PINS	6 PINS	
$R_{\theta JA}$	Junction-to-ambient thermal resistance	169.8	162.5	°C/W
$R_{\theta JC(top)}$	Junction-to-case (top) thermal resistance	120.5	78.8	°C/W
$R_{\theta JB}$	Junction-to-board thermal resistance	63.2	42.1	°C/W
$\Psi_{JT}$	Junction-to-top characterization parameter	45.9	21.2	°C/W
$\Psi_{JB}$	Junction-to-board characterization parameter	63.0	41.9	°C/W
$R_{\theta JC(bot)}$	Junction-to-case (bottom) thermal resistance	-	-	°C/W

- (1) For more information about traditional and new thermal metrics, see the [Semiconductor and IC Package Thermal Metrics](#) report.

### 5.4 Recommended Operating Conditions

over operating free-air temperature range (unless otherwise noted)

		MIN	MAX	UNIT
Supply voltage: $V_S = (V+) - (V-)$		1.8	5.5	V
Supply voltage: $V_S = (V+) - (V-)$	B-Versions	1.65	5.5	V
Input voltage range from (V-)		-0.2	(V+) + 0.2	V
Output voltage range from (V-) for open drain		-0.2	(V+)	V
Output voltage range from (V-) for open drain	B-Versions	-0.2	5.5	V
Ambient temperature, $T_A$		-40	125	°C

## 5.5 Electrical Characteristics

For  $V_S$  (TOTAL SUPPLY VOLTAGE) =  $(V+) - (V-) = 1.8V$  and  $5.5V$ ,  $V_{CM} = V_S/2$  at  $T_A = 25^\circ C$  (Unless otherwise noted)

PARAMETER		TEST CONDITIONS	MIN	TYP	MAX	UNIT
<b>OFFSET VOLTAGE</b>						
$V_{OS}$	Input offset voltage	$V_{CM} = (V-)$	-6	±0.3	6	mV
$V_{OS}$	Input offset voltage	$V_{CM} = (V-)$ $T_A = -40^\circ C$ to $+125^\circ C$	-9		9	mV
$dV_{IO}/dT$	Input offset voltage drift	$V_{CM} = (V-)$ $T_A = -40^\circ C$ to $+125^\circ C$		±12		$\mu V/^\circ C$
PSRR	power supply rejection ratio	$V_{CM} = (V-)$ $V_S = 1.8V$ to $5.5V$ $T_A = -40^\circ C$ to $+125^\circ C$		100	1000	$\mu V/V$
PSRR	power supply rejection ratio (B-Versions)	$V_{CM} = (V-)$ $V_S = 1.65V$ to $5.5V$ $T_A = -40^\circ C$ to $+125^\circ C$		100	1000	$\mu V/V$
$V_{HYS}$	Input hysteresis voltage	$T_A = -40^\circ C$ to $+125^\circ C$	2	6	8	mV
<b>INPUT BIAS CURRENT</b>						
$I_B$	Input bias current	$V_{CM} = V_S/2$	-10 <sup>(1)</sup>	±4.5	10 <sup>(1)</sup>	pA
$I_{OS}$	Input offset current	$V_{CM} = V_S/2$	-10 <sup>(1)</sup>	±1	10 <sup>(1)</sup>	pA
<b>INPUT COMMON MODE RANGE</b>						
$V_{CM-Range}$	Common-mode voltage range	$V_S = 1.8V$ to $5.5V$	$(V-) - 0.2$		$(V+) + 0.2$	V
CMRR	Common mode rejection ratio	$V_{CM} = (V-) + 1.5V$ to $(V+) + 0.2V$ $V_S = 5.5V$	60	74		dB
CMRR	Common mode rejection ratio	$V_{CM} = (V-) - 0.2V$ to $(V+) + 0.2V$ $V_S = 5.5V$	54	62		dB
$R_{CM}$	Input Common Mode Resistance			$10^{13}$		$\Omega$
$C_{IC}$	Input Common Mode Capacitance			2		pF
<b>INPUT IMPEDANCE</b>						
$R_{DM}$	Input Differential Mode Resistance			$10^{13}$		$\Omega$
$C_{ID}$	Input Differential Mode Capacitance			4		pF
<b>OUTPUT</b>						
$V_{OL}$	Voltage swing from $(V-)$	$V_S = 5V$ $I_{SINK} = 5mA$ $T_A = -40^\circ C$ to $+125^\circ C$		160	200	mV
$V_{OH}$	Voltage swing from $(V+)$ (for Push-Pull only)	$V_S = 5V$ $I_{SOURCE} = 5mA$ $T_A = -40^\circ C$ to $+125^\circ C$		90	200	mV
<b>VOLTAGE REFERENCE</b>						
$V_{OUT}$	Reference Voltage		1.223	1.242	1.260	V
	Accuracy			±0.25%	±1.5%	
$dV_{OUT}/dT$	Temperature Drift	$T_A = -40^\circ C$ to $+125^\circ C$		40	100	ppm/ $^\circ C$
$dV_{OUT}/dI_{LOAD}$	Load Regulation, Sourcing	$0mA < I_{SOURCE} \leq 0.5mA$		0.36	1 <sup>(1)</sup>	mV/mA

## 5.5 Electrical Characteristics (続き)

For  $V_S$  (TOTAL SUPPLY VOLTAGE) =  $(V+) - (V-) = 1.8V$  and  $5.5V$ ,  $V_{CM} = V_S/2$  at  $T_A = 25^\circ C$  (Unless otherwise noted)

PARAMETER		TEST CONDITIONS	MIN	TYP	MAX	UNIT
	Load Regulation, Sinking	$0mA < I_{SINK} \leq 0.5mA$		6.6		mV/mA
I <sub>LOAD</sub>	Output Current			0.5		mA
$dV_{OUT}/dV_S$	Line Regulation	$1.8V \leq V_S \leq 5.5V$		10	100 <sup>(1)</sup>	$\mu V/V$
$dV_{OUT}/dV_S$	Line Regulation (B-Versions)	$1.65V \leq V_S \leq 5.5V$		10	100 <sup>(1)</sup>	$\mu V/V$
$V_{noise}$	Noise	$f = 0.1Hz$ to $10Hz$		0.2		mV <sub>PP</sub>
<b>POWER SUPPLY</b>						
I <sub>Q</sub>	Quiescent current per comparator	Output is logic high		2.8	5	$\mu A$
I <sub>Q</sub>	Quiescent current per comparator	Output is logic high $T_A = -40^\circ C$ to $+125^\circ C$			7	$\mu A$
I <sub>Q</sub>	Quiescent current per comparator (B-Versions)	Output is logic high		2.4	3.1	$\mu A$
I <sub>Q</sub>	Quiescent current per comparator (B-Versions)	Output is logic high $T_A = -40^\circ C$ to $+125^\circ C$			3.6	$\mu A$

(1) Verified by characterization

## 5.6 Switching Characteristics

For  $V_S$  (TOTAL SUPPLY VOLTAGE) =  $(V+) - (V-) = 1.8V$  and  $5.5V$ ,  $V_{CM} = V_S / 2$  at  $T_A = 25^\circ C$  (Unless otherwise noted)

PARAMETER		TEST CONDITIONS	MIN	TYP	MAX	UNIT
<b>OUTPUT</b>						
$T_{PD-LH}$	Propagation delay time, low-to-high	$f = 10kHz, V_{STEP} = 1V, V_{OD} = 10mV, C_L = 10pF$		12		$\mu s$
$T_{PD-LH}$	Propagation delay time, low-to-high	$f = 10kHz, V_{STEP} = 1V, V_{OD} = 100mV, C_L = 10pF$		6		$\mu s$
$T_{PD-LH}$	Propagation delay time, low-to-high (push-pull output, B-Version)	$f = 10kHz, V_{STEP} = 200mV, V_{OD} = 100mV, C_L = 10pF$		2	4	$\mu s$
$T_{PD-HL}$	Propagation delay time, high-to-low	$f = 10kHz, V_{STEP} = 1V, V_{OD} = 10mV, C_L = 10pF$		13.5		$\mu s$
$T_{PD-HL}$	Propagation delay time, high-to-low	$f = 10kHz, V_{STEP} = 1V, V_{OD} = 100mV, C_L = 10pF$		6.5		$\mu s$
$T_{PD-HL}$	Propagation delay time, high-to-low (B-Versions)	$f = 10kHz, V_{STEP} = 200mV, V_{OD} = 100mV, C_L = 10pF$		2	4	$\mu s$
$T_{RISE}$	Output Rise Time, 20% to 80%, push-pull output	$C_L = 10pF$		100		ns
$T_{RISE}$	Output Rise Time, 20% to 80%, push-pull output (B-Versions)	$C_L = 10pF$		10		ns
$T_{RISE}$	Output Rise Time, 20% to 80%, open-drain output	$R_L = 10k\Omega, C_L = 10pF$		200		ns
$T_{FALL}$	Output Fall Time, 80% to 20%	$C_L = 10pF$		100		ns
$T_{FALL}$	Output Fall Time, 80% to 20% (B-Versions)	$C_L = 10pF$		10		ns
$T_{FALL}$	Output Fall Time, 80% to 20%, open-drain output	$R_L = 10k\Omega, C_L = 10pF$		200		ns
$T_{FALL}$	Output Fall Time, 80% to 20%, open-drain output (B-Versions)	$R_L = 10k\Omega, C_L = 10pF$		10		ns
$t_{ON}$	Power on-time (B-Versions)			1.9		ms

## 6 Typical Characteristics

For  $V_S$  (Total Supply Voltage) =  $(V+) - (V-) = +5V$ ,  $V_{CM} = V_S / 2$  at  $T_A = 25^\circ C$ ,  $R_{PULLUP} = 1M\Omega$  to  $V+$ ,  $C_L = 15pF$ ,  $V_{OD} = 100mV$  unless otherwise noted.

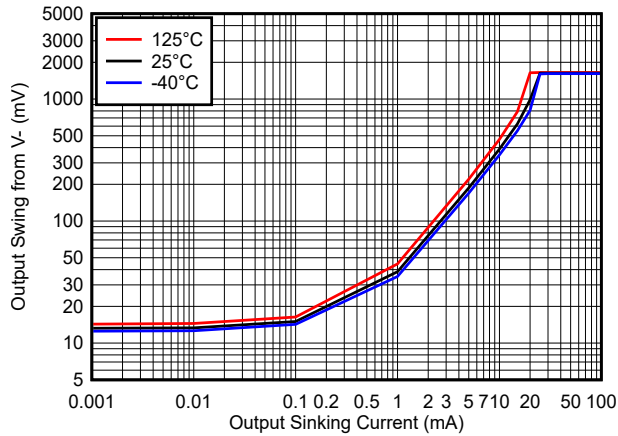

6-1. Output Swing vs. Output Sinking Current - 1.8V

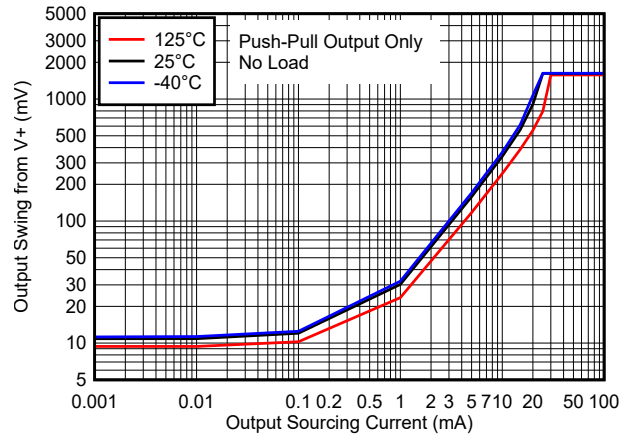

6-2. Output Swing vs. Output Sourcing Current - 1.8V

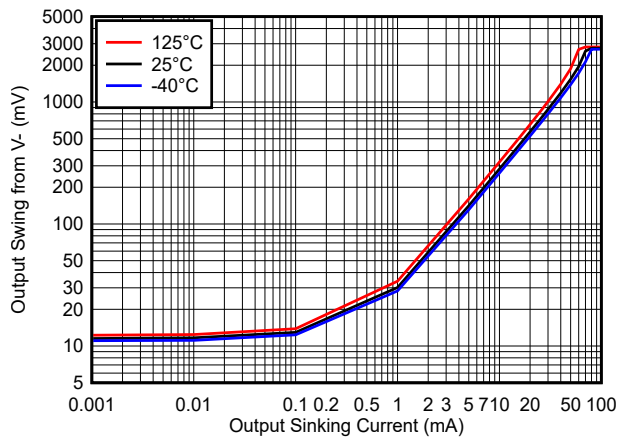

6-3. Output Swing vs. Output Sinking Current - 3.3V

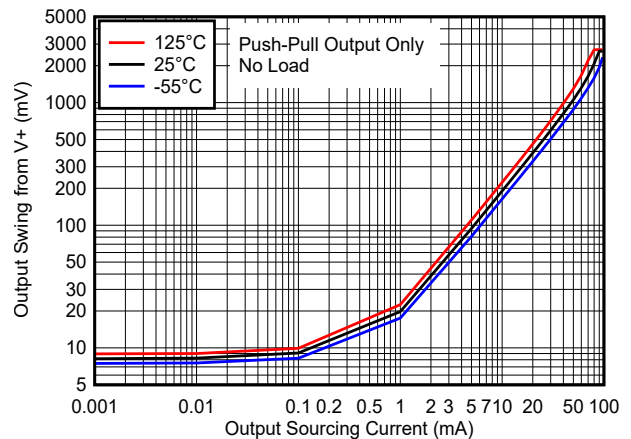

6-4. Output Swing vs. Output Sourcing Current - 3.3V

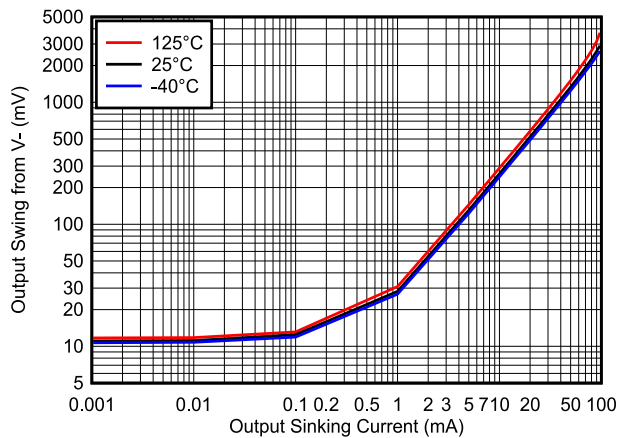

6-5. Output Swing vs. Output Sinking Current - 5V

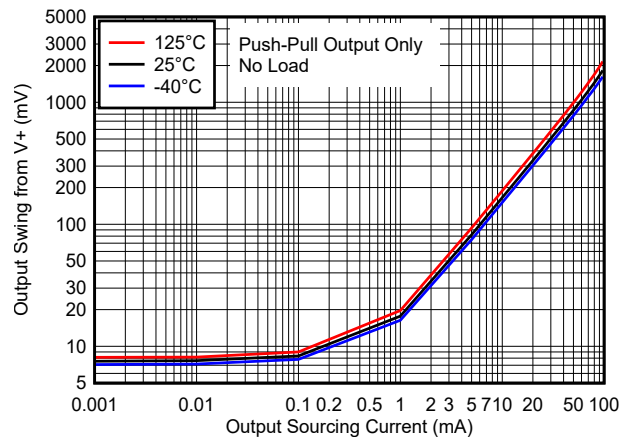

6-6. Output Swing vs. Output Sourcing Current - 5V



## 6 Typical Characteristics (continued)

For  $V_S$  (Total Supply Voltage) =  $(V+) - (V-) = +5V$ ,  $V_{CM} = V_S / 2$  at  $T_A = 25^\circ C$ ,  $R_{PULLUP} = 1M\Omega$  to  $V+$ ,  $C_L = 15pF$ ,  $V_{OD} = 100mV$  unless otherwise noted.

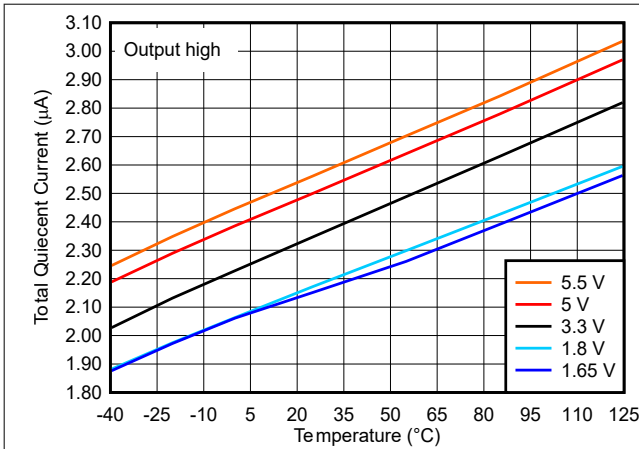

Figure 6-7. Supply Current vs. Temperature

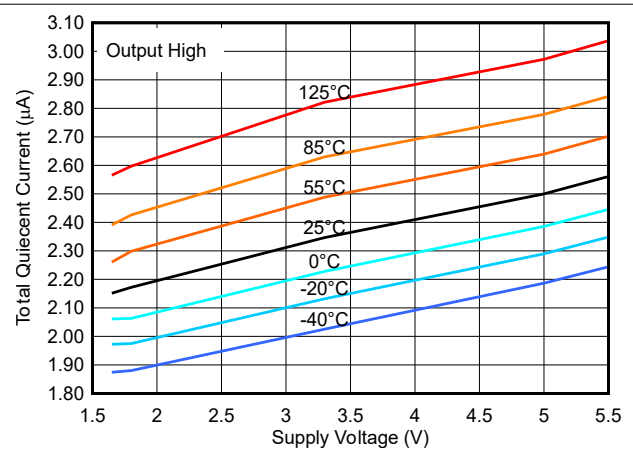

Figure 6-8. Supply Current vs. Supply Voltage

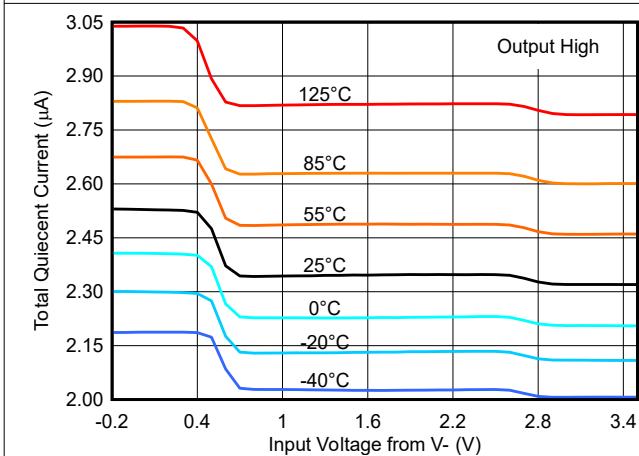

Figure 6-9. Supply Current vs. Common Mode - 3.3V

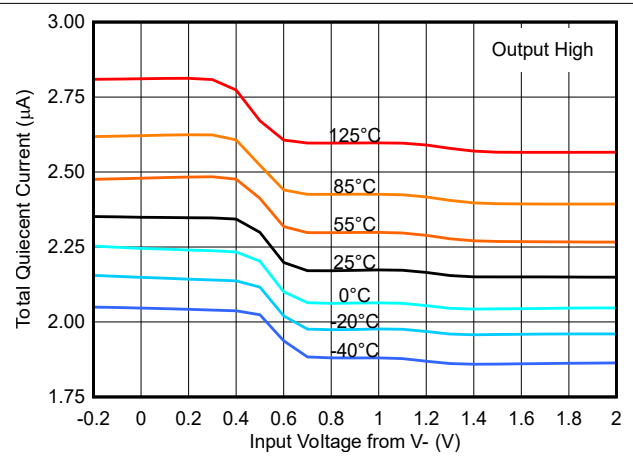

Figure 6-10. Supply Current vs. Common Mode - 1.8V

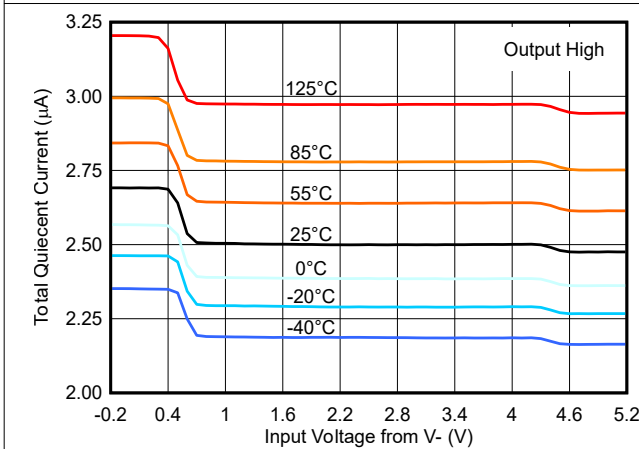

Figure 6-11. Supply Current vs. Common Mode - 5V

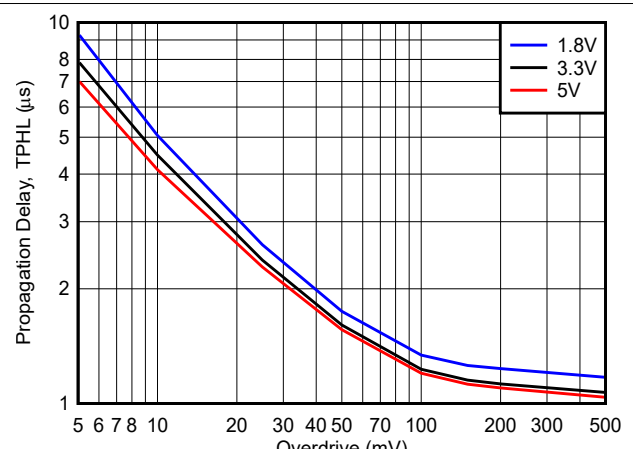

Figure 6-12. High to Low Propagation Delay vs. Overdrive

## 6 Typical Characteristics (continued)

For  $V_S$  (Total Supply Voltage) =  $(V+) - (V-) = +5V$ ,  $V_{CM} = V_S / 2$  at  $T_A = 25^\circ C$ ,  $R_{PULLUP} = 1M\Omega$  to  $V+$ ,  $C_L = 15pF$ ,  $V_{OD} = 100mV$  unless otherwise noted.

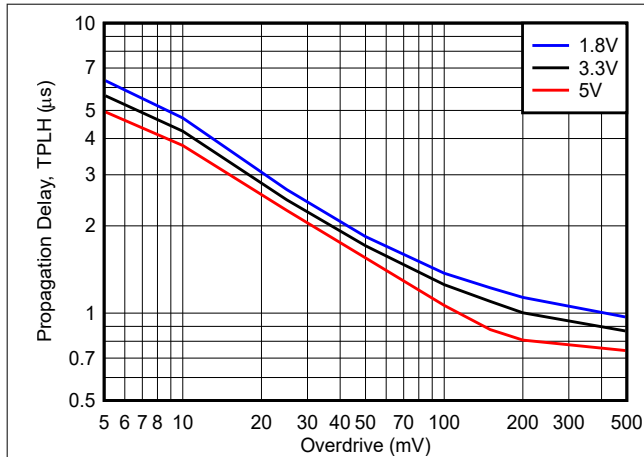

Figure 6-13. Low to High Propagation Delay vs. Overdrive

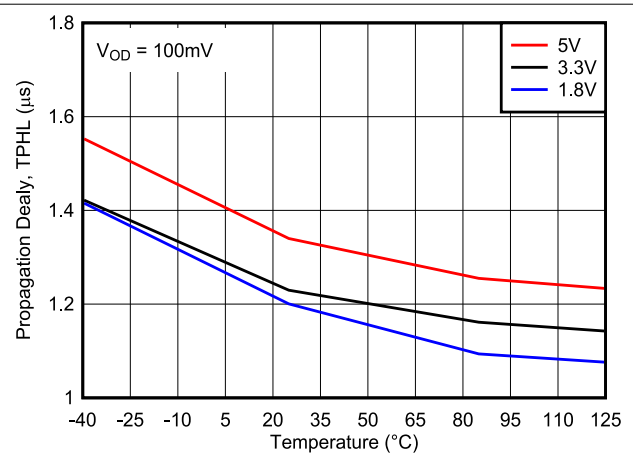

Figure 6-14. High to Low Propagation Delay vs. Temperature

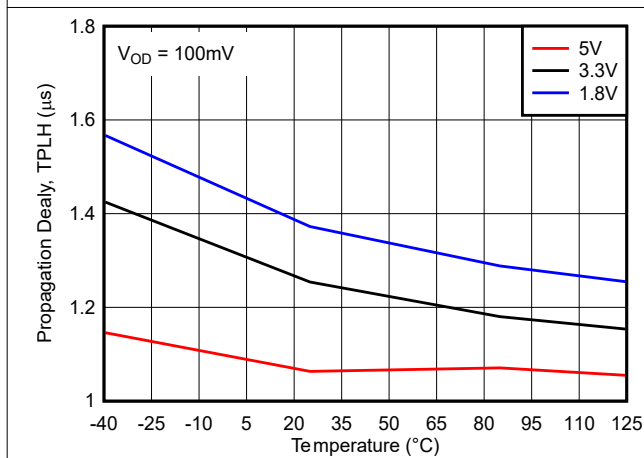

Figure 6-15. Low to High Propagation Delay vs. Temperature

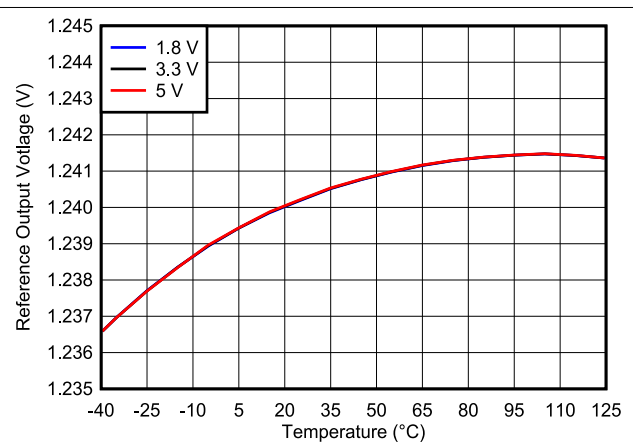

Figure 6-16. Reference Voltage vs. Temperature

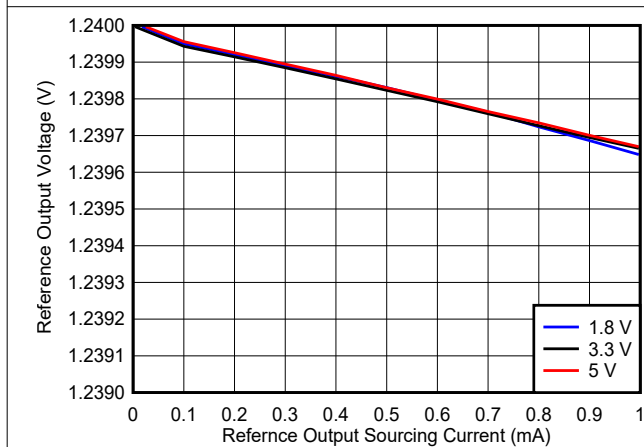

Figure 6-17. Reference Voltage vs. Reference Output Sourcing Current

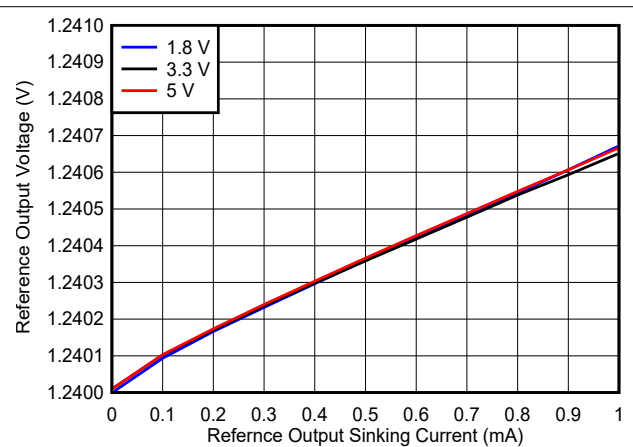
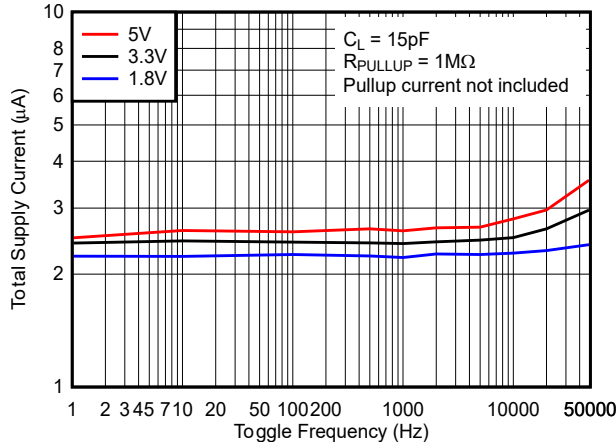

Figure 6-18. Reference Voltage vs. Reference Output Sinking Current

## 6 Typical Characteristics (continued)

For  $V_S$  (Total Supply Voltage) =  $(V+) - (V-) = +5V$ ,  $V_{CM} = V_S / 2$  at  $T_A = 25^\circ C$ ,  $R_{PULLUP} = 1M\Omega$  to  $V+$ ,  $C_L = 15pF$ ,  $V_{OD} = 100mV$  unless otherwise noted.



6-19. Supply Current vs. Toggle Frequency - Open Drain Output

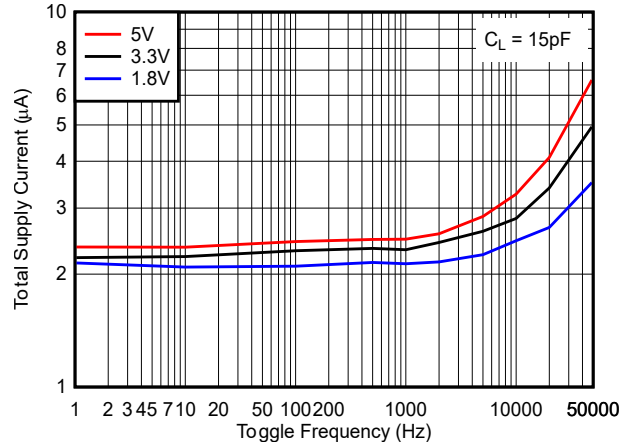

6-20. Supply Current vs. Toggle Frequency - Push-Pull Output

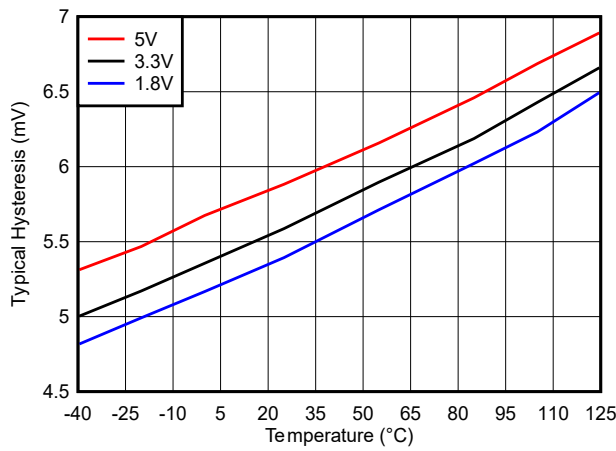

6-21. Hysteresis Voltage vs. Temperature

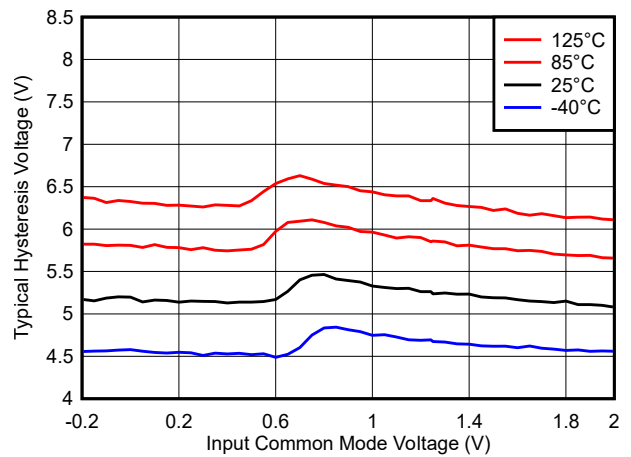

6-22. Hysteresis Voltage vs. Common Mode, 1.8V

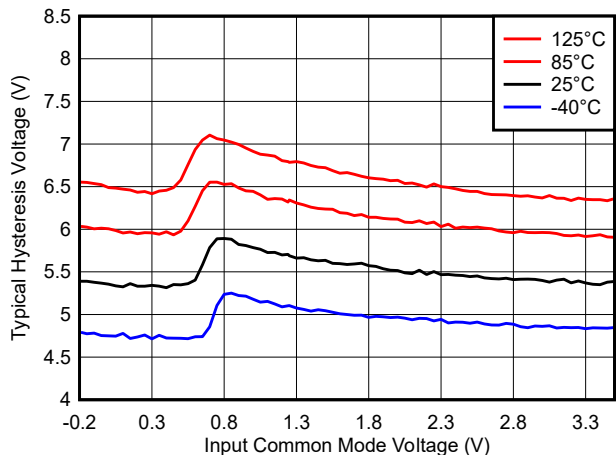

6-23. Hysteresis Voltage vs. Common Mode, 3.3V

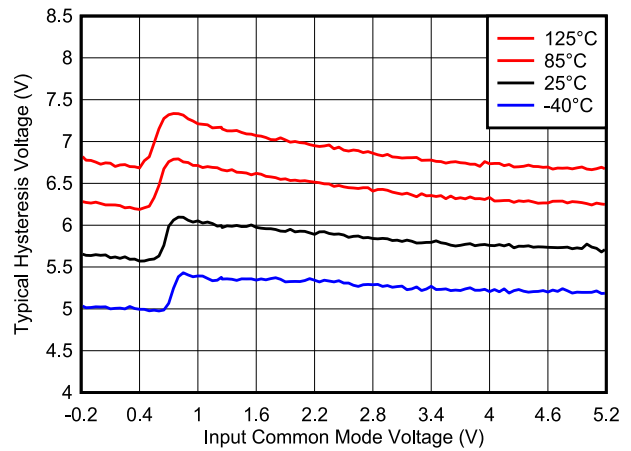

6-24. Hysteresis Voltage vs. Common Mode, 5V

## 6 Typical Characteristics (continued)

For  $V_S$  (Total Supply Voltage) =  $(V+) - (V-) = +5V$ ,  $V_{CM} = V_S / 2$  at  $T_A = 25^\circ C$ ,  $R_{PULLUP} = 1M\Omega$  to  $V+$ ,  $C_L = 15pF$ ,  $V_{OD} = 100mV$  unless otherwise noted.

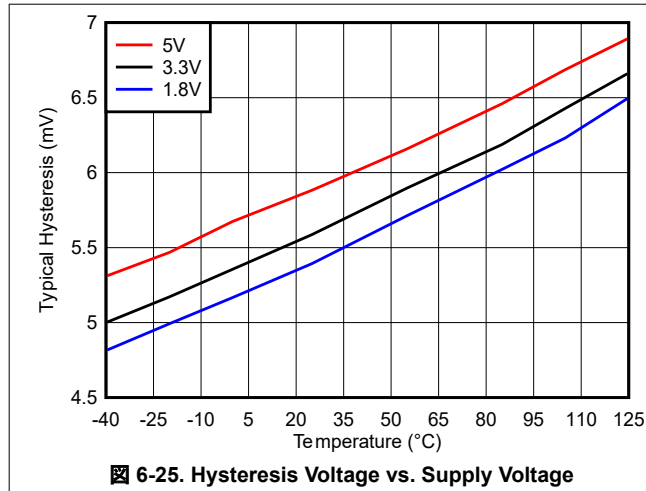

Figure 6-25. Hysteresis Voltage vs. Supply Voltage

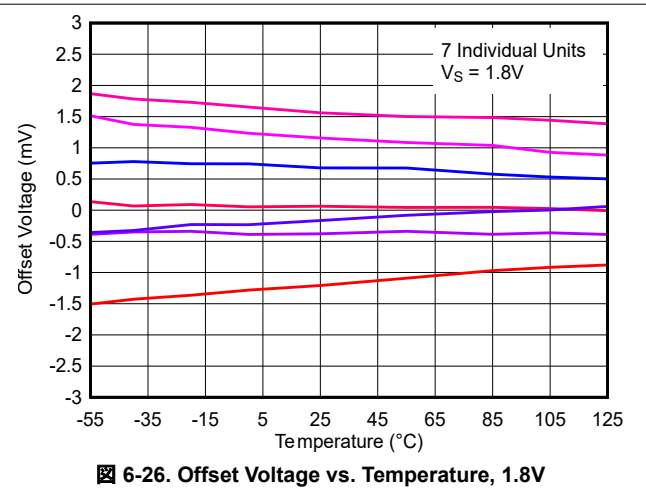

Figure 6-26. Offset Voltage vs. Temperature, 1.8V

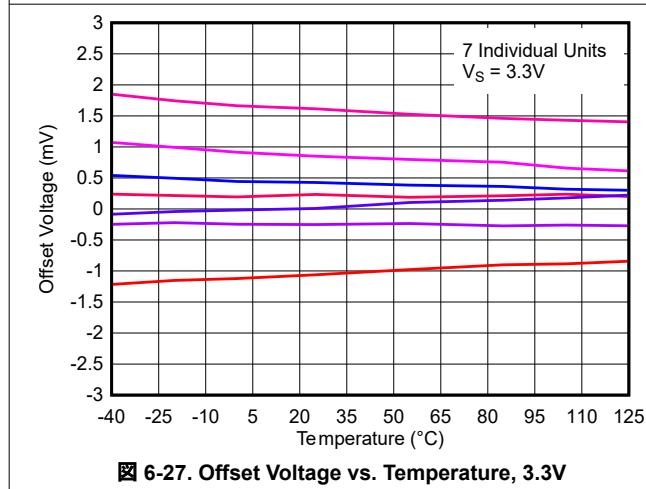

Figure 6-27. Offset Voltage vs. Temperature, 3.3V

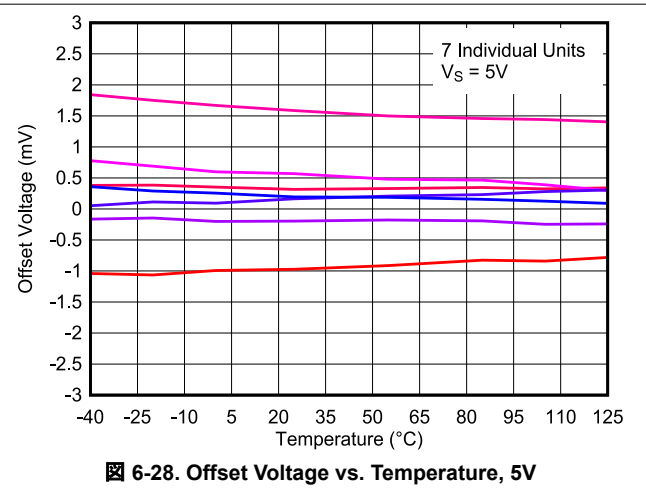

Figure 6-28. Offset Voltage vs. Temperature, 5V

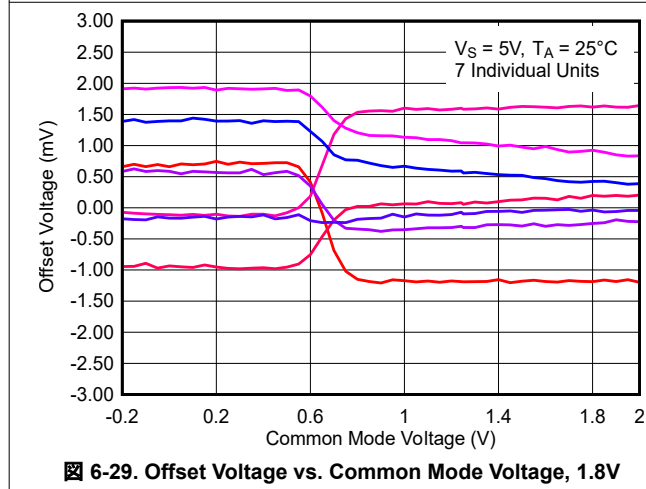

Figure 6-29. Offset Voltage vs. Common Mode Voltage, 1.8V

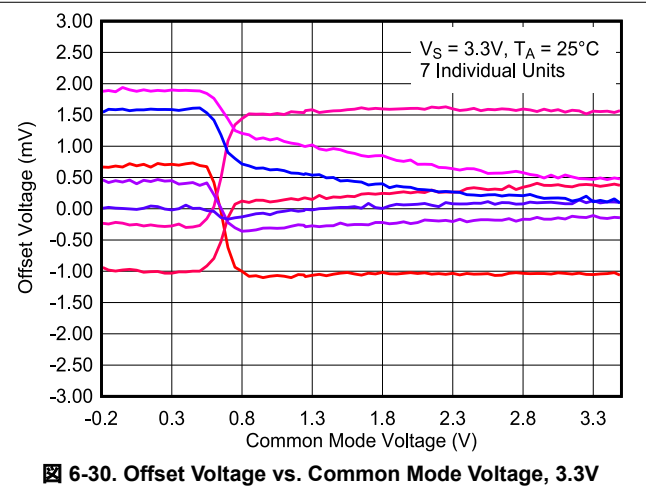
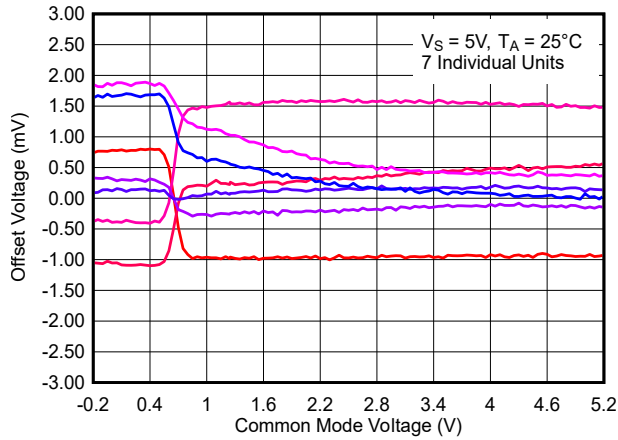

Figure 6-30. Offset Voltage vs. Common Mode Voltage, 3.3V

## 6 Typical Characteristics (continued)

For  $V_S$  (Total Supply Voltage) =  $(V+) - (V-) = +5V$ ,  $V_{CM} = V_S / 2$  at  $T_A = 25^\circ C$ ,  $R_{PULLUP} = 1M\Omega$  to  $V+$ ,  $C_L = 15pF$ ,  $V_{OD} = 100mV$  unless otherwise noted.



6-31. Offset Voltage vs. Common Mode Voltage, 5V

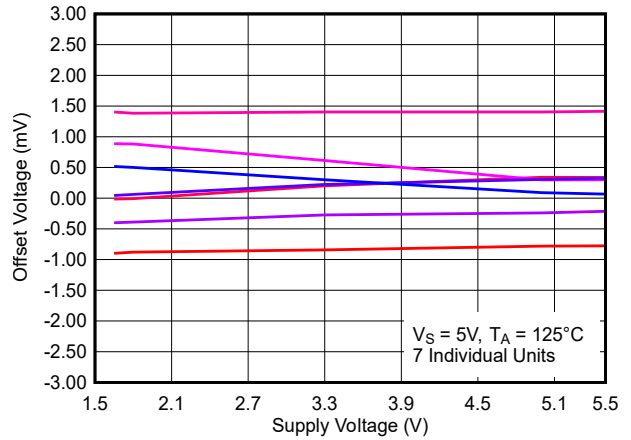

6-32. Offset Voltage vs. Supply Voltage, 125°C

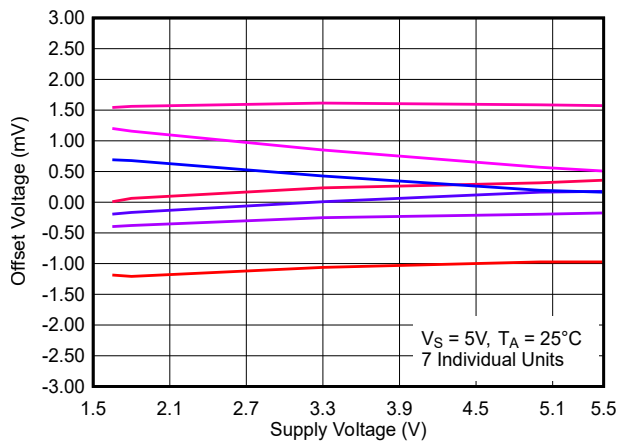

6-33. Offset Voltage vs. Supply Voltage, 25°C

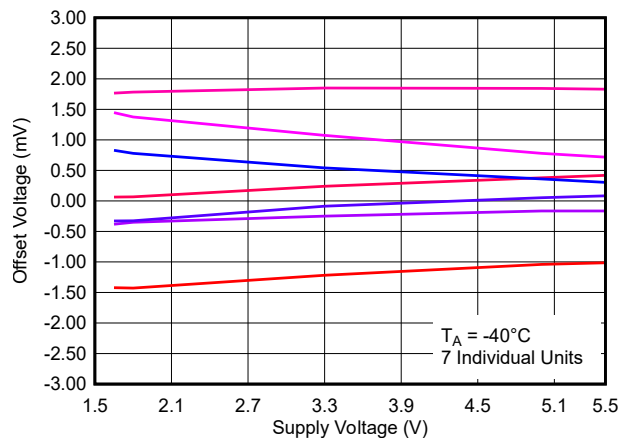

6-34. Offset Voltage vs. Supply Voltage, -40°C

## 7 Detailed Description

### 7.1 Overview

The TLV301x-Q1 is a MicroPower comparator with an integrated reference that is well suited for compact, low-current, precision voltage detection applications. With a high-accuracy, internal reference of 1.242V and low quiescent current, the TLV301x-Q1 enables power conscious systems to monitor and respond quickly to fault conditions. Throughout this data sheet, rev "B" is only specified when there is a difference.

### 7.2 Functional Block Diagram

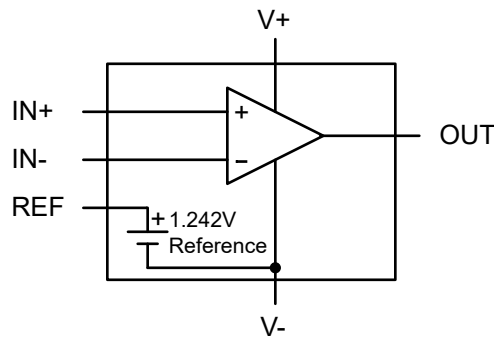

### 7.3 Feature Description

The TLV301x-Q1 is comprised of a rail-to-rail input comparator with open-drain or push-pull output options and a voltage reference that is externally available.

### 7.4 Device Functional Modes

The TLV301x-Q1 requires an operating voltage between 1.8V and 5.5V for the comparator output to reflect the voltage applied to the inputs. Similarly, the reference output (REF) is valid over the same operating voltage range. The "B" versions add power on reset, fail-safe inputs and a 1.65V minimum supply voltage.

#### 7.4.1 Open Drain Output (TLV3011-Q1 and TLV3011B-Q1)

The TLV3011-Q1 features an Open-Drain (sinking only) output that allows multiple devices to be driven by a single pull-up resistor to accomplish an OR function, making the TLV3011-Q1 useful for logic applications. The value of the pull-up resistor and supply voltage used affects current consumption due to additional current drawn when the output is in a low state. This effect can be seen in the typical curve Quiescent Current vs Output Switching Frequency.

For the TLV3011-Q1, the pull-up voltage must be less than, or equal to, the V+ supply voltage ( $V_{PULLUP} \leq V+$ ).

The TLV3011B-Q1 output can be pulled-up to any voltage up to 5.5V, regardless of the supply voltage.

#### 7.4.2 Push-Pull Output (TLV3012-Q1 and TLV3012B-Q1)

The TLV3012-Q1 has a "Push-Pull" output capable of both sinking and sourcing current. The push-pull output stage is an excellent choice for reduced power budget applications by eliminating the need for a pull-up resistor and features no shoot-through current. Do not tie push-pull outputs together.

#### 7.4.3 Voltage Reference

The integrated 1.242V voltage reference offers low 100ppm/°C (maximum) drift provided on a separate output pin that allows use of external dividers or to provide a reference voltage for other external circuitry. The reference is stable with up to a 10nF capacitive load and can sink or source up to 500µA (typical) of output current.

#### 7.4.4 Internal Hysteresis

The TLV301x-Q1 and TLV301xB-Q1 have typically 6mV of built-in hysteresis. External hysteresis can still be added as explained in the section [Adding External Hysteresis](#).

### 7.4.5 TLV3011B-Q1 and TLV3012B-Q1 Fail-Safe inputs

The TLV3011B-Q1 and TLV3012B-Q1 inputs are Fail-Safe up to 5.5V independent of V+ voltage. Fail-Safe is defined as maintaining the same high input impedance when V+ is unpowered or within the recommended operating ranges.

The Fail-Safe inputs can be any value between 0V and 5.5V, even while V+ is zero or ramping up or down. This feature avoids power sequencing issues as long as the input voltage range and supply voltage are within the specified ranges. This is possible since the inputs are not clamped to V+ and the input current maintains the value even when a higher voltage is applied to the inputs.

As long as one of the input pins remains within the valid input range, and the supply voltage is valid and not in POR, the output state is correct.

The following is a summary of the TLV3011B-Q1 and TLV3012B-Q1 device input voltage excursions and the outcomes:

- When both IN- and IN+ are within the specified input voltage range:
  - If IN- is higher than IN+ and the offset voltage, the output is low.
  - If IN- is lower than IN+ and the offset voltage, the output is high.
- When IN- is higher than the specified input voltage range and IN+ is within the specified voltage range, the output is low.
- When IN+ is higher than the specified input voltage range and IN- is within the specified input voltage range, the output is high
- When IN- and IN+ are both outside the specified input voltage range, the output state is **indeterminate** (random). *Do not* operate in this region.

Because the inputs do not have upper ESD diode clamps to V+, input voltages must be externally clamped to below 5.5V if the source can possibly exceed 5.5V. A current limiting resistor in series with the input is also recommend in case of input transients.

### 7.4.6 TLV3011B-Q1 and TLV3012B-Q1 Power On Reset

The TLV3011B-Q1 and TLV3012B-Q1 have an internal Power-on-Reset (POR) circuit for known start-up or power-down conditions. While the power supply (V+) is ramping up or ramping down, the POR circuitry is activated for up to 1.9ms after the minimum supply voltage threshold is crossed, or immediately when the supply voltage drops below minimum supply. When the supply voltage is equal to or greater than the minimum supply voltage, and after the delay period, the comparator output reflects the state of the differential input (V<sub>ID</sub>). This delay is long enough to allow the reference output to stabilize with up to a 10nF capacitive load.

During the POR period (t<sub>on</sub>), the outputs are as follows:

- The open drain output TLV3011B-Q1 is high (Hi-Z).
- The push-pull output TLV3012B-Q1 is low (sinking).

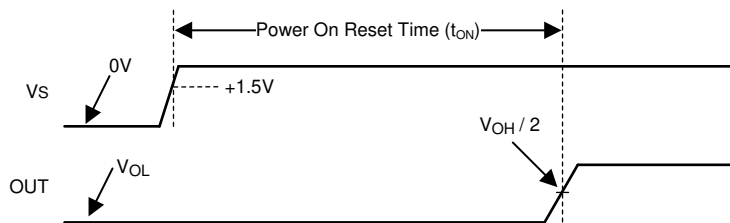

☒ 7-1. Power-On Reset Example Timing Diagram for Push-Pull Output

Note the nature of an open collector output is that that the output rises with the pull-up voltage during the HI-Z POR period.

## 8 Application and Implementation

### 注

以下のアプリケーション情報は、TI の製品仕様に含まれるものではなく、TI ではその正確性または完全性を保証いたしません。個々の目的に対する製品の適合性については、お客様の責任で判断していただくこととなります。お客様は自身の設計実装を検証しテストすることで、システムの機能を確認する必要があります。

### 8.1 Application Information

The TLV301x-Q1 and TLV301xB-Q1 comparator family with on-chip 1.242V series reference with the choice of either open-drain or push-pull output stages.

A typical supply current of 2.4μA and small packaging combined with 1.65V supply requirements make the TLV301xB-Q1 devices an excellent choice for battery and portable designs.

Shown below are the typical connections for the TLV3012-Q1 device.

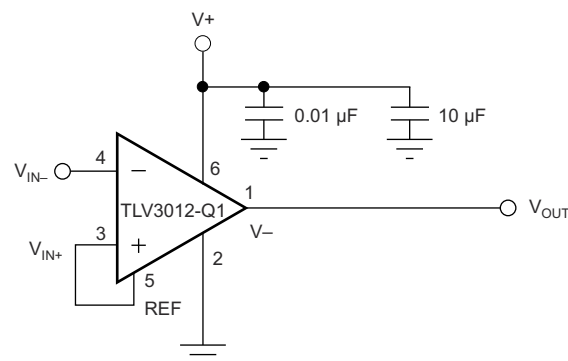

Copyright © 2016, Texas Instruments Incorporated

**8-1. Basic Connections**

#### 8.1.1 Adding External Hysteresis

For noisy input signals, the comparator output can display multiple switching as input signals move through the switching threshold. The typical hysteresis of the TLV301x-Q1 family is 6 mV (±3mV). To increase the overall hysteresis, external hysteresis can be added by connecting a small amount of feedback to the positive input. This external hysteresis adds to the internal hysteresis. Shown below is a typical topology used to introduce external hysteresis.

$$V_{\text{HYST}} = \frac{V+ \times R1}{R1 + R2} \quad (1)$$



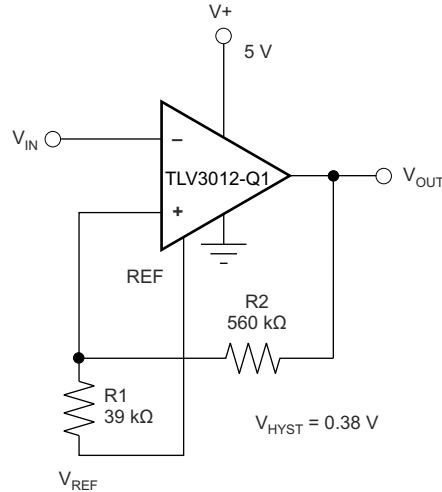

Copyright © 2016, Texas Instruments Incorporated

**図 8-2. Adding External Hysteresis**

The  $V_{HYST}$  voltage sets the value of the transition voltage required to switch the comparator output by increasing the threshold region, thereby reducing sensitivity to noise.

## 8.2 Typical Application

### 8.2.1 Under-Voltage Detection

Under-voltage detection is frequently required to alert the system that a battery voltage has dropped below the usable voltage level. Figure 23 shows a simple under-voltage detection circuit using the TLV3012-Q1 which is configured as a non-inverting comparator with the integrated 1.242V reference is externally connected to the inverting input pin (IN-).

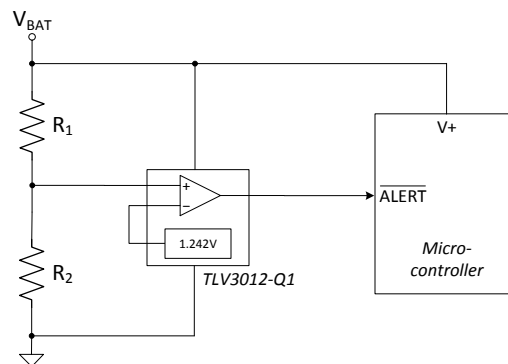

**図 8-3. Under-Voltage Detection**

#### 8.2.1.1 Design Requirements

For this design, follow these design requirements:

- Operate from power supply that powers the microcontroller.
- Under-voltage alert is active low.
- Logic low output when  $V_{BAT}$  is less than 2.0V.

#### 8.2.1.2 Detailed Design Procedure

Configure the circuit as shown above. Connect ( $V+$ ) to  $V_{BAT}$  which also powers the microcontroller. Resistors  $R_1$  and  $R_2$  create the under-voltage alert level of 2.0V. When the battery voltage sags down to 2.0V, the resistor divider voltage crosses  $V_{REF}$ , the 1.242V reference threshold of the TLV3012-Q1. This causes the comparator

output to transition from a logic high to a logic low. The push-pull output of the TLV3012-Q1 is selected since the comparator operating voltage is shared with the microcontroller which is receiving the under-voltage alert signal.

式 2 is derived from the analysis of 図 8-3.

$$V_{REF} = \frac{R_2}{R_1 + R_2} \times V_{BAT} \quad (2)$$

where

- $R_1$  and  $R_2$  are the resistor values for the resistor divider connected to IN+
- $V_{BAT}$  is the voltage source that is being monitored for an undervoltage condition.
- $V_{REF}$  is the falling edge threshold where the comparator output changes state from high to low

Rearranging the equation and solving for  $R_1$  yields this result.

$$R_1 = \frac{(V_{BAT} - V_{REF})}{V_{REF}} \times R_2 \quad (3)$$

For the specific undervoltage detection of 2.0V using the TLV3012-Q1, the following results are calculated.

$$R_1 = \frac{(2.0 - 1.242)}{1.242} \times 1M = 610 \text{ k}\Omega \quad (4)$$

where

- $R_2$  is set to 1M $\Omega$
- $V_{BAT}$  is set to 2.0V
- $V_{REF}$  is set to 1.242V

Choose  $R_{TOTAL}$  ( $R_1 + R_2$ ) such that the current through the divider is at least 100 times higher than the input bias current ( $I_{BIAS}$ ). The resistors can have high values to minimize current consumption in the circuit without adding significant error to the resistive divider.

### 8.2.1.3 Application Curve

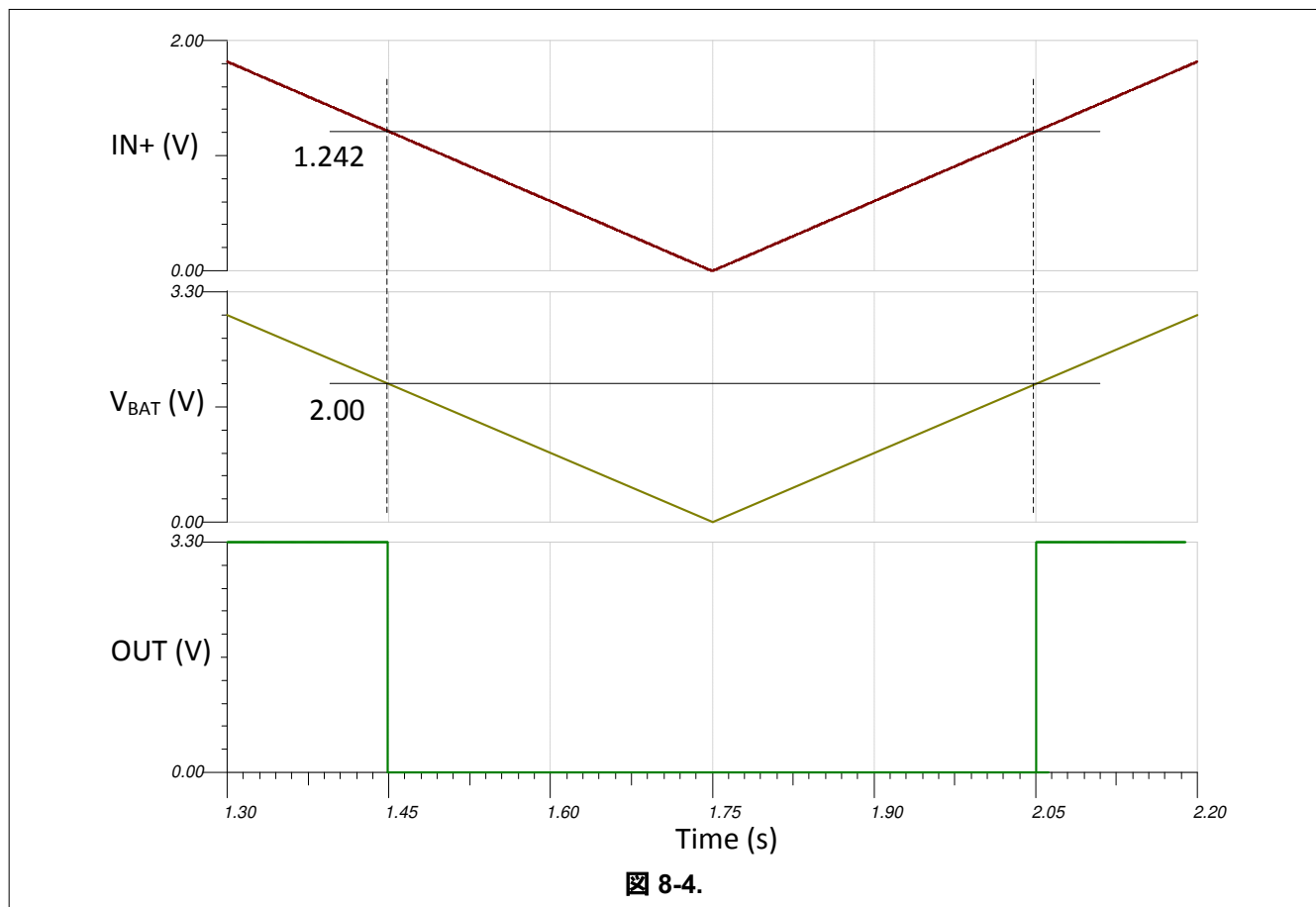

## 8.3 System Examples

### 8.3.1 Power-On Reset

The reset circuit shown below provides a time-delayed release of reset to the [MSP430™ microcontroller](#). Operation of the circuit is based on a stabilization time constant of the supply voltage, rather than on a predetermined voltage value. The negative input is a reference voltage created by the internal voltage reference. The positive input is an RC circuit that provides a power-up delay. When power is applied, the output of the comparator is low, holding the processor in the reset condition. Only after allowing time for the supply voltage to stabilize does the positive input of the comparator become higher than the negative input, resulting in a high output state, releasing the processor for operation. The stabilization time required for the supply voltage is adjustable by the selection of the RC component values. Use of a lower-valued resistor in this portion of the circuit does not increase current consumption, because no current flows through the RC circuit after the supply has stabilized.

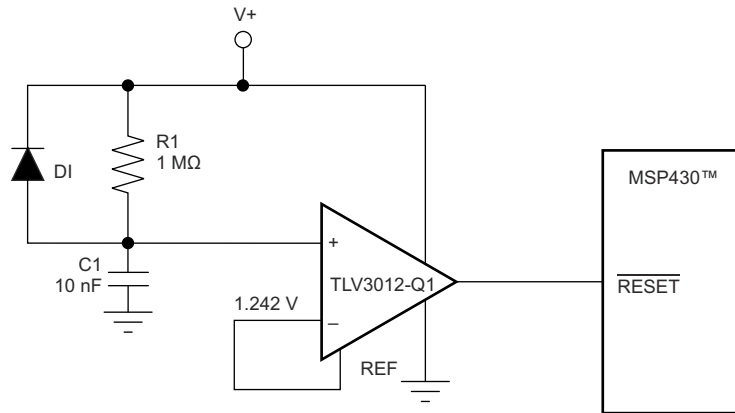

Copyright © 2016, Texas Instruments Incorporated

**図 8-5. TLV3012-Q1 Configured as Power-Up Reset Circuit for the MSP430™ Microcontroller**

The reset delay needed depends on the power-up characteristics of the system power supply.  $R_1$  and  $C_1$  are selected to allow enough time for the power supply to stabilize.  $D_1$  provides rapid reset if power is lost. In this example, the  $R_1 \times C_1$  time constant is 10 ms.

### 8.3.2 Relaxation Oscillator

Shown below, the TLV3012-Q1 device can be configured as a relaxation oscillator to provide a simple and inexpensive clock output. The capacitor is charged at a rate of  $T = 0.69RC$  and discharges at a rate of  $0.69RC$ . Therefore, the period is  $T = 1.38RC$ .  $R_1$  can be a different value than  $R_2$ .

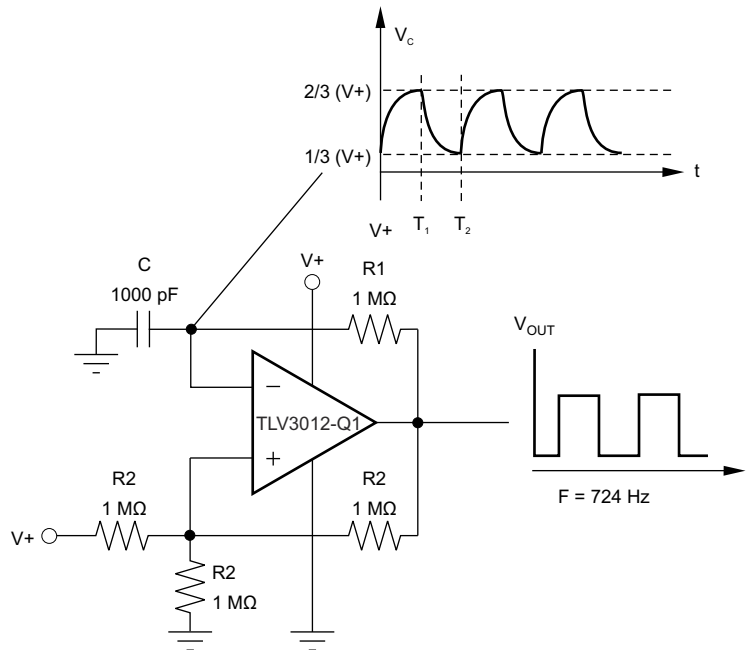

Copyright © 2016, Texas Instruments Incorporated

**図 8-6. TLV3012-Q1 Configured as Relaxation Oscillator**

## 8.4 Power Supply Recommendations

The TLV3012-Q1 has a recommended operating voltage range ( $V_S$ ) of 1.8V to 5.5V.  $V_S$  is defined as  $(V+) - (V-)$ . Therefore, the supply voltages used to create  $V_S$  can be single-ended or bipolar. For example, single-ended supply voltages of 5V and 0V and bipolar supply voltages of +2.5V and -2.5V create comparable operating voltages for  $V_S$ . However, when bipolar supply voltages are used, realize that the reference (REF) and logic low level of the comparator output is referenced to  $(V-)$ . Output capacitive loading and output toggle rate causes the average supply current to rise over the quiescent current in the EC Table.

## 8.5 Layout

### 8.5.1 Layout Guidelines

To minimize supply noise, power supplies must be capacitively decoupled by a 0.1 $\mu$ F ceramic capacitor. Comparators are sensitive to input noise and precautions such as proper grounding (use of ground plane), supply bypassing, and guarding of high-impedance nodes minimize the effects of noise and help specified performance.

### 8.5.2 Layout Example



图 8-7. Layout Example

## 9 Device and Documentation Support

### 9.1 ドキュメントの更新通知を受け取る方法

ドキュメントの更新についての通知を受け取るには、[www.tij.co.jp](http://www.tij.co.jp) のデバイス製品フォルダを開いてください。[通知] をクリックして登録すると、変更されたすべての製品情報に関するダイジェストを毎週受け取ることができます。変更の詳細については、改訂されたドキュメントに含まれている改訂履歴をご覧ください。

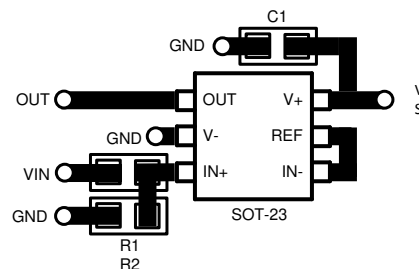
### 9.2 サポート・リソース

テキサス・インスツルメンツ E2E™ サポート・フォーラムは、エンジニアが検証済みの回答と設計に関するヒントをエキスパートから迅速かつ直接得ることができる場所です。既存の回答を検索したり、独自の質問をしたりすることで、設計に必要な支援を迅速に得ることができます。

リンクされているコンテンツは、各寄稿者により「現状のまま」提供されるものです。これらはテキサス・インスツルメンツの仕様を構成するものではなく、必ずしもテキサス・インスツルメンツの見解を反映したものではありません。テキサス・インスツルメンツの[使用条件](#)を参照してください。

### 9.3 Trademarks

MSP430™ is a trademark of Texas Instruments.

テキサス・インスツルメンツ E2E™ is a trademark of Texas Instruments.

すべての商標は、それぞれの所有者に帰属します。

### 9.4 静電気放電に関する注意事項



この IC は、ESD によって破損する可能性があります。テキサス・インスツルメンツは、IC を取り扱う際には常に適切な注意を払うことを推奨します。正しい取り扱いおよび設置手順に従わない場合、デバイスを破損するおそれがあります。

ESD による破損は、わずかな性能低下からデバイスの完全な故障まで多岐にわたります。精密な IC の場合、パラメータがわずかに変化するだけで公表されている仕様から外れる可能性があるため、破損が発生しやすくなっています。

### 9.5 用語集

[テキサス・インスツルメンツ用語集](#) この用語集には、用語や略語の一覧および定義が記載されています。

## 10 Revision History

資料番号末尾の英字は改訂を表しています。その改訂履歴は英語版に準じています。

Changes from Revision C (April 2023) to Revision D (January 2025)	Page
• TLV3012-Q1 DCK パッケージのみの絶対最大値表を削除しました (1 つの表に結合).....	1
• TLV3012-Q1 DCK パッケージのみの熱に関する情報表を削除しました (1 つの表に結合).....	1
• TLV3012-Q1 DCK パッケージのみの電気的特性表を削除しました (1 つの表に結合).....	1
• TLV3012-Q1 DCK パッケージのみのスイッチング特性表を削除しました (1 つの表に結合).....	1
• TLV3012-Q1 DCK パッケージのみの代表的特性の曲線を削除しました.....	1
• フロント ページにある製品情報表のタイトルをパッケージ情報に変更.....	1
• Updated Supply Current Graphs.....	8

Changes from Revision B (August 2022) to Revision C (April 2023)	Page
• 先頭ページのテキストと表に TLV3011B-Q1 と TLV3012B-Q1 を追加.....	1

Changes from Revision A (June 2019) to Revision B (August 2022)	Page
• DBV パッケージと DCK パッケージの両方に TLV3011-Q1 を追加.....	1
• SOT-23 (DBV) に TLV3012-Q1 を追加.....	1

- DBV パッケージの新しい表を追加..... 1
- ドキュメント全体にわたって表、図、相互参照の採番方法を更新..... 1

<b>Changes from Revision * (March 2011) to Revision A (June 2019)</b>	<b>Page</b>
• HBM と CDM の ESD 定格および分類レベルを追加。AEC-Q100 デバイスの温度グレードも追加.....	1
• 「ピン構成および機能」セクション、「ESD 定格」表、「機能説明」セクション、「デバイスの機能モード」セクション、「アプリケーションと実装」セクション、「電源に関する推奨事項」セクション、「レイアウト」セクション、「デバイスおよびドキュメントのサポート」セクション、「メカニカル、パッケージ、および注文情報」セクションを追加 .....	1
• データシートから TLV3011-Q1 デバイスを削除し、TLV3012-Q1 の部品番号から A を削除.....	1
• Deleted the <i>Package Ordering Information</i> section.....	3

## 11 Mechanical, Packaging, and Orderable Information

The following pages include mechanical, packaging, and orderable information. This information is the most current data available for the designated devices. This data is subject to change without notice and revision of this document. For browser-based versions of this data sheet, refer to the left-hand navigation.

## 重要なお知らせと免責事項

テキサス・インスツルメンツは、技術データと信頼性データ (データシートを含みます)、設計リソース (リファレンス デザインを含みます)、アプリケーションや設計に関する各種アドバイス、Web ツール、安全性情報、その他のリソースを、欠陥が存在する可能性のある「現状のまま」提供しており、商品性および特定目的に対する適合性の黙示保証、第三者の知的財産権の非侵害保証を含むいかなる保証も、明示的または黙示的にかかわらず拒否します。

これらのリソースは、テキサス・インスツルメンツ製品を使用する設計の経験を積んだ開発者への提供を意図したものです。(1) お客様のアプリケーションに適した テキサス・インスツルメンツ製品の選定、(2) お客様のアプリケーションの設計、検証、試験、(3) お客様のアプリケーションに該当する各種規格や、その他のあらゆる安全性、セキュリティ、規制、または他の要件への確実な適合に関する責任を、お客様のみが単独で負うものとします。

上記の各種リソースは、予告なく変更される可能性があります。これらのリソースは、リソースで説明されている テキサス・インスツルメンツ製品を使用するアプリケーションの開発の目的でのみ、テキサス・インスツルメンツはその使用をお客様に許諾します。これらのリソースに関して、他の目的で複製することや掲載することは禁止されています。テキサス・インスツルメンツや第三者の知的財産権のライセンスが付与されている訳ではありません。お客様は、これらのリソースを自身で使用した結果発生するあらゆる申し立て、損害、費用、損失、責任について、テキサス・インスツルメンツおよびその代理人を完全に補償するものとし、テキサス・インスツルメンツは一切の責任を拒否します。

テキサス・インスツルメンツの製品は、[テキサス・インスツルメンツの販売条件](#)、または [ti.com](https://www.ti.com) やかかる テキサス・インスツルメンツ製品の関連資料などのいずれかを通じて提供する適用可能な条項の下で提供されています。テキサス・インスツルメンツがこれらのリソースを提供することは、適用されるテキサス・インスツルメンツの保証または他の保証の放棄の拡大や変更を意味するものではありません。

お客様がいかなる追加条項または代替条項を提案した場合でも、テキサス・インスツルメンツはそれらに異議を唱え、拒否します。

郵送先住所: Texas Instruments, Post Office Box 655303, Dallas, Texas 75265

Copyright © 2025, Texas Instruments Incorporated



**PACKAGING INFORMATION**

Orderable part number	Status (1)	Material type (2)	Package   Pins	Package qty   Carrier	RoHS (3)	Lead finish/ Ball material (4)	MSL rating/ Peak reflow (5)	Op temp (°C)	Part marking (6)
<a href="#">TLV3011AQDBVRQ1</a>	Active	Production	SOT-23 (DBV)   6	3000   LARGE T&R	Yes	NIPDAU	Level-1-260C-UNLIM	-40 to 125	2Q7F
TLV3011AQDBVRQ1.A	Active	Production	SOT-23 (DBV)   6	3000   LARGE T&R	Yes	NIPDAU	Level-1-260C-UNLIM	-40 to 125	2Q7F
<a href="#">TLV3011AQDCKRQ1</a>	Active	Production	SC70 (DCK)   6	3000   LARGE T&R	Yes	NIPDAU	Level-1-260C-UNLIM	-40 to 125	1M6
TLV3011AQDCKRQ1.A	Active	Production	SC70 (DCK)   6	3000   LARGE T&R	Yes	NIPDAU	Level-1-260C-UNLIM	-40 to 125	1M6
<a href="#">TLV3011BQDBVRQ1</a>	Active	Production	SOT-23 (DBV)   6	3000   LARGE T&R	Yes	NIPDAU	Level-1-260C-UNLIM	-40 to 125	311F
TLV3011BQDBVRQ1.A	Active	Production	SOT-23 (DBV)   6	3000   LARGE T&R	Yes	NIPDAU	Level-1-260C-UNLIM	-40 to 125	311F
<a href="#">TLV3011BQDCKRQ1</a>	Active	Production	SC70 (DCK)   6	3000   LARGE T&R	Yes	NIPDAU	Level-1-260C-UNLIM	-40 to 125	1O6
TLV3011BQDCKRQ1.A	Active	Production	SC70 (DCK)   6	3000   LARGE T&R	Yes	NIPDAU	Level-1-260C-UNLIM	-40 to 125	1O6
<a href="#">TLV3012AQDBVRQ1</a>	Active	Production	SOT-23 (DBV)   6	3000   LARGE T&R	Yes	NIPDAU	Level-1-260C-UNLIM	-40 to 125	2Q8F
TLV3012AQDBVRQ1.A	Active	Production	SOT-23 (DBV)   6	3000   LARGE T&R	Yes	NIPDAU	Level-1-260C-UNLIM	-40 to 125	2Q8F
<a href="#">TLV3012AQDCKRQ1</a>	Active	Production	SC70 (DCK)   6	3000   LARGE T&R	Yes	NIPDAU	Level-1-260C-UNLIM	-40 to 125	BPF
TLV3012AQDCKRQ1.A	Active	Production	SC70 (DCK)   6	3000   LARGE T&R	Yes	NIPDAU	Level-1-260C-UNLIM	-40 to 125	BPF
TLV3012AQDCKRQ1.B	Active	Production	SC70 (DCK)   6	3000   LARGE T&R	Yes	NIPDAU	Level-1-260C-UNLIM	-40 to 125	BPF
<a href="#">TLV3012BQDBVRQ1</a>	Active	Production	SOT-23 (DBV)   6	3000   LARGE T&R	Yes	NIPDAU	Level-1-260C-UNLIM	-40 to 125	31JF
TLV3012BQDBVRQ1.A	Active	Production	SOT-23 (DBV)   6	3000   LARGE T&R	Yes	NIPDAU	Level-1-260C-UNLIM	-40 to 125	31JF
<a href="#">TLV3012BQDCKRQ1</a>	Active	Production	SC70 (DCK)   6	3000   LARGE T&R	Yes	NIPDAU	Level-1-260C-UNLIM	-40 to 125	1O7
TLV3012BQDCKRQ1.A	Active	Production	SC70 (DCK)   6	3000   LARGE T&R	Yes	NIPDAU	Level-1-260C-UNLIM	-40 to 125	1O7

(1) **Status:** For more details on status, see our [product life cycle](#).

(2) **Material type:** When designated, preproduction parts are prototypes/experimental devices, and are not yet approved or released for full production. Testing and final process, including without limitation quality assurance, reliability performance testing, and/or process qualification, may not yet be complete, and this item is subject to further changes or possible discontinuation. If available for ordering, purchases will be subject to an additional waiver at checkout, and are intended for early internal evaluation purposes only. These items are sold without warranties of any kind.

(3) **RoHS values:** Yes, No, RoHS Exempt. See the [TI RoHS Statement](#) for additional information and value definition.

(4) **Lead finish/Ball material:** Parts may have multiple material finish options. Finish options are separated by a vertical ruled line. Lead finish/Ball material values may wrap to two lines if the finish value exceeds the maximum column width.

(5) **MSL rating/Peak reflow:** The moisture sensitivity level ratings and peak solder (reflow) temperatures. In the event that a part has multiple moisture sensitivity ratings, only the lowest level per JEDEC standards is shown. Refer to the shipping label for the actual reflow temperature that will be used to mount the part to the printed circuit board.

**(6) Part marking:** There may be an additional marking, which relates to the logo, the lot trace code information, or the environmental category of the part.

Multiple part markings will be inside parentheses. Only one part marking contained in parentheses and separated by a "~" will appear on a part. If a line is indented then it is a continuation of the previous line and the two combined represent the entire part marking for that device.

**Important Information and Disclaimer:** The information provided on this page represents TI's knowledge and belief as of the date that it is provided. TI bases its knowledge and belief on information provided by third parties, and makes no representation or warranty as to the accuracy of such information. Efforts are underway to better integrate information from third parties. TI has taken and continues to take reasonable steps to provide representative and accurate information but may not have conducted destructive testing or chemical analysis on incoming materials and chemicals. TI and TI suppliers consider certain information to be proprietary, and thus CAS numbers and other limited information may not be available for release.

In no event shall TI's liability arising out of such information exceed the total purchase price of the TI part(s) at issue in this document sold by TI to Customer on an annual basis.

**OTHER QUALIFIED VERSIONS OF TLV3011-Q1, TLV3011B-Q1, TLV3012-Q1, TLV3012B-Q1 :**

● Catalog : [TLV3011](#), [TLV3011B](#), [TLV3012](#), [TLV3012B](#)

● Enhanced Product : [TLV3011-EP](#), [TLV3012-EP](#)

NOTE: Qualified Version Definitions:

- Catalog - TI's standard catalog product
- Enhanced Product - Supports Defense, Aerospace and Medical Applications

**TAPE AND REEL INFORMATION**

**QUADRANT ASSIGNMENTS FOR PIN 1 ORIENTATION IN TAPE**

\*All dimensions are nominal

Device	Package Type	Package Drawing	Pins	SPQ	Reel Diameter (mm)	Reel Width W1 (mm)	A0 (mm)	B0 (mm)	K0 (mm)	P1 (mm)	W (mm)	Pin1 Quadrant
TLV3011AQDBVRQ1	SOT-23	DBV	6	3000	180.0	8.4	3.2	3.2	1.4	4.0	8.0	Q3
TLV3011AQDCKRQ1	SC70	DCK	6	3000	178.0	9.0	2.4	2.5	1.2	4.0	8.0	Q3
TLV3011BQDBVRQ1	SOT-23	DBV	6	3000	180.0	8.4	3.2	3.2	1.4	4.0	8.0	Q3
TLV3011BQDCKRQ1	SC70	DCK	6	3000	178.0	9.0	2.4	2.5	1.2	4.0	8.0	Q3
TLV3012AQDBVRQ1	SOT-23	DBV	6	3000	180.0	8.4	3.2	3.2	1.4	4.0	8.0	Q3
TLV3012AQDCKRQ1	SC70	DCK	6	3000	178.0	9.0	2.4	2.5	1.2	4.0	8.0	Q3
TLV3012BQDBVRQ1	SOT-23	DBV	6	3000	180.0	8.4	3.2	3.2	1.4	4.0	8.0	Q3
TLV3012BQDCKRQ1	SC70	DCK	6	3000	178.0	9.0	2.4	2.5	1.2	4.0	8.0	Q3

**TAPE AND REEL BOX DIMENSIONS**

\*All dimensions are nominal

Device	Package Type	Package Drawing	Pins	SPQ	Length (mm)	Width (mm)	Height (mm)
TLV3011AQDBVRQ1	SOT-23	DBV	6	3000	210.0	185.0	35.0
TLV3011AQDCKRQ1	SC70	DCK	6	3000	180.0	180.0	18.0
TLV3011BQDBVRQ1	SOT-23	DBV	6	3000	210.0	185.0	35.0
TLV3011BQDCKRQ1	SC70	DCK	6	3000	180.0	180.0	18.0
TLV3012AQDBVRQ1	SOT-23	DBV	6	3000	210.0	185.0	35.0
TLV3012AQDCKRQ1	SC70	DCK	6	3000	180.0	180.0	18.0
TLV3012BQDBVRQ1	SOT-23	DBV	6	3000	210.0	185.0	35.0
TLV3012BQDCKRQ1	SC70	DCK	6	3000	180.0	180.0	18.0

# DBV0006A



# PACKAGE OUTLINE

SOT-23 - 1.45 mm max height

SMALL OUTLINE TRANSISTOR



4214840/G 08/2024

**NOTES:**

1. All linear dimensions are in millimeters. Any dimensions in parenthesis are for reference only. Dimensioning and tolerancing per ASME Y14.5M.
2. This drawing is subject to change without notice.
3. Body dimensions do not include mold flash or protrusion. Mold flash and protrusion shall not exceed 0.25 per side.
4. Leads 1,2,3 may be wider than leads 4,5,6 for package orientation.
5. Reference JEDEC MO-178.

# EXAMPLE BOARD LAYOUT

DBV0006A

SOT-23 - 1.45 mm max height

SMALL OUTLINE TRANSISTOR



LAND PATTERN EXAMPLE  
EXPOSED METAL SHOWN  
SCALE:15X

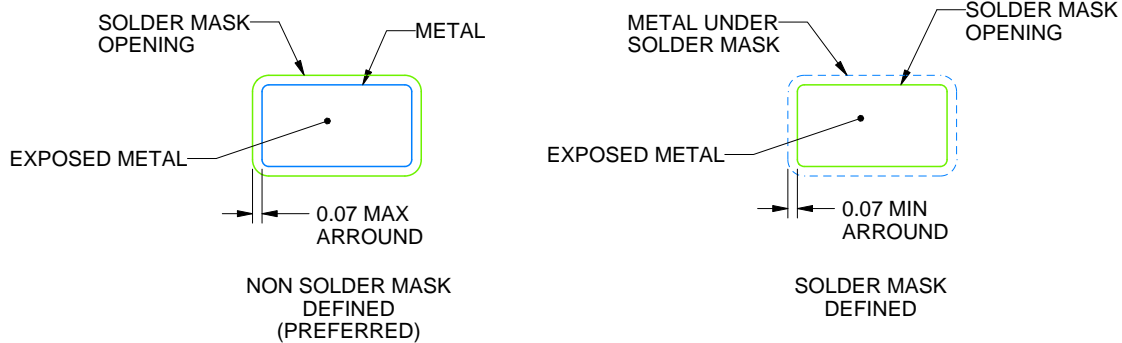

SOLDER MASK DETAILS

4214840/G 08/2024

NOTES: (continued)

6. Publication IPC-7351 may have alternate designs.
7. Solder mask tolerances between and around signal pads can vary based on board fabrication site.

# EXAMPLE STENCIL DESIGN

DBV0006A

SOT-23 - 1.45 mm max height

SMALL OUTLINE TRANSISTOR



SOLDER PASTE EXAMPLE  
BASED ON 0.125 mm THICK STENCIL  
SCALE:15X

4214840/G 08/2024

NOTES: (continued)

8. Laser cutting apertures with trapezoidal walls and rounded corners may offer better paste release. IPC-7525 may have alternate design recommendations.
9. Board assembly site may have different recommendations for stencil design.

# DCK0006A



# PACKAGE OUTLINE

SOT - 1.1 max height

SMALL OUTLINE TRANSISTOR

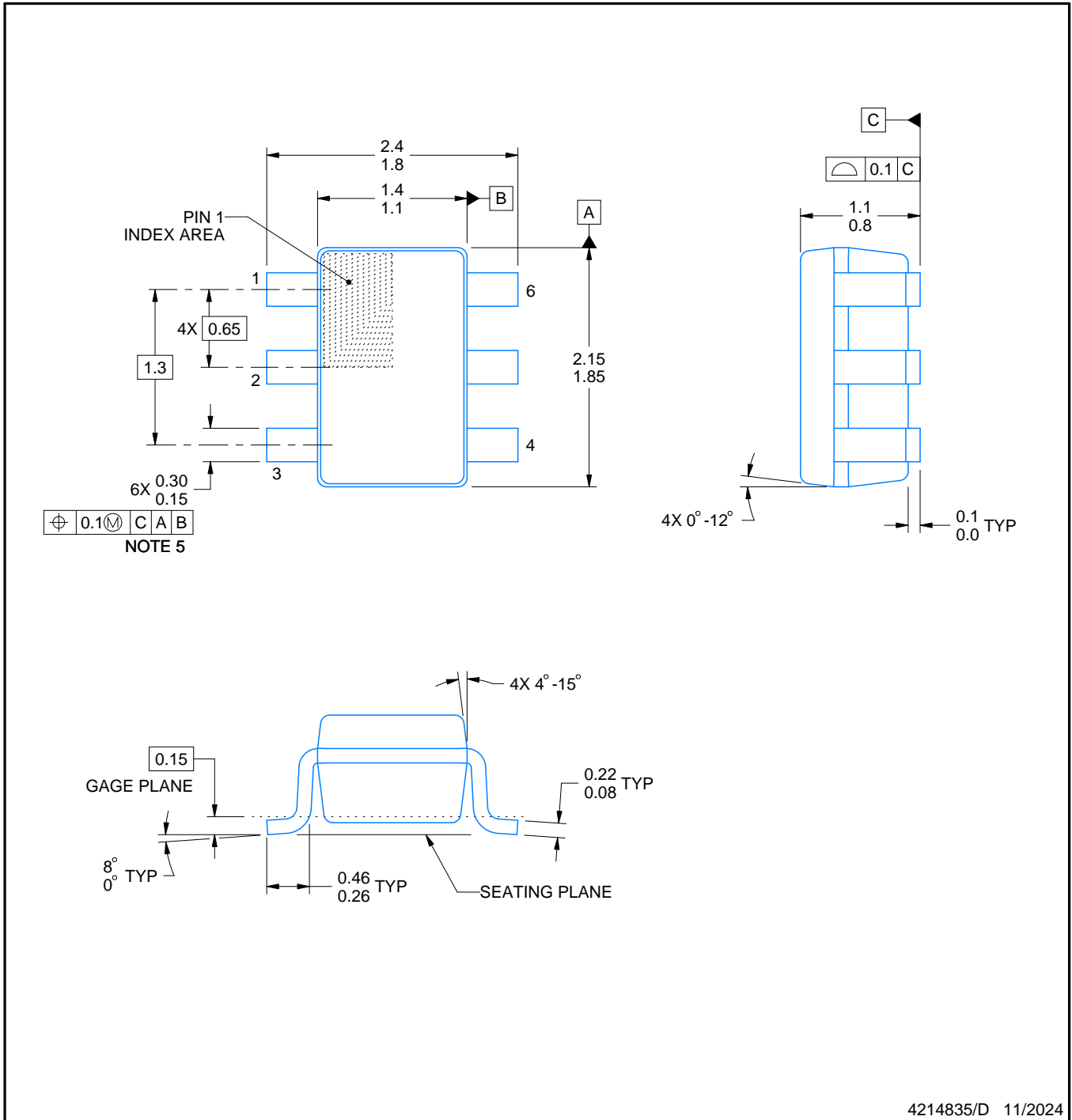

4214835/D 11/2024

**NOTES:**

1. All linear dimensions are in millimeters. Any dimensions in parenthesis are for reference only. Dimensioning and tolerancing per ASME Y14.5M.
2. This drawing is subject to change without notice.
3. Body dimensions do not include mold flash or protrusion. Mold flash and protrusion shall not exceed 0.15 per side.
4. Falls within JEDEC MO-203 variation AB.



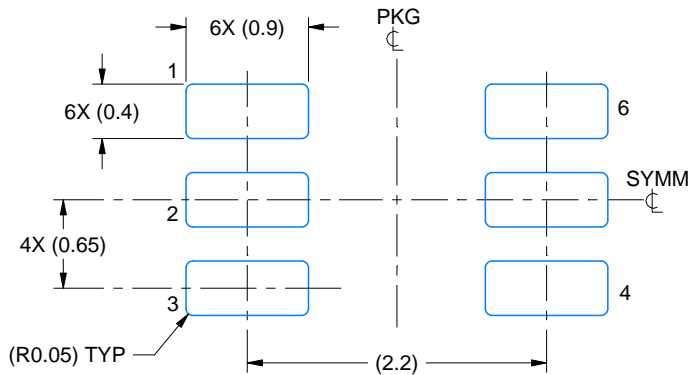

LAND PATTERN EXAMPLE  
EXPOSED METAL SHOWN  
SCALE:18X

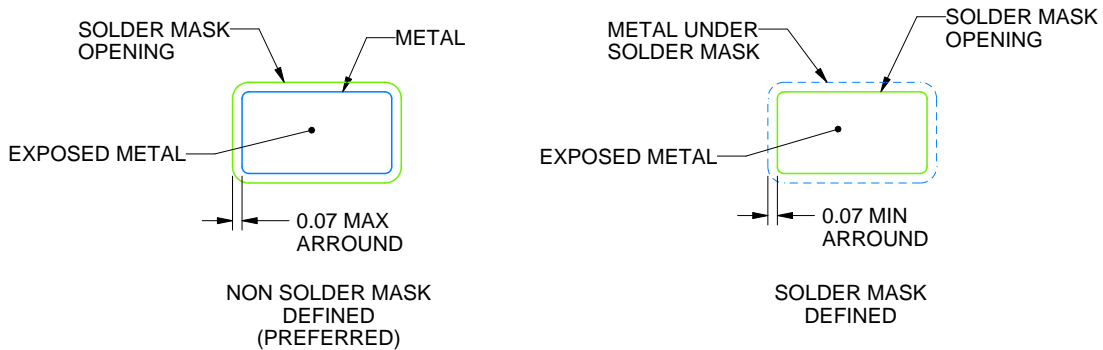

SOLDER MASK DETAILS

4214835/D 11/2024

NOTES: (continued)

5. Publication IPC-7351 may have alternate designs.
6. Solder mask tolerances between and around signal pads can vary based on board fabrication site.

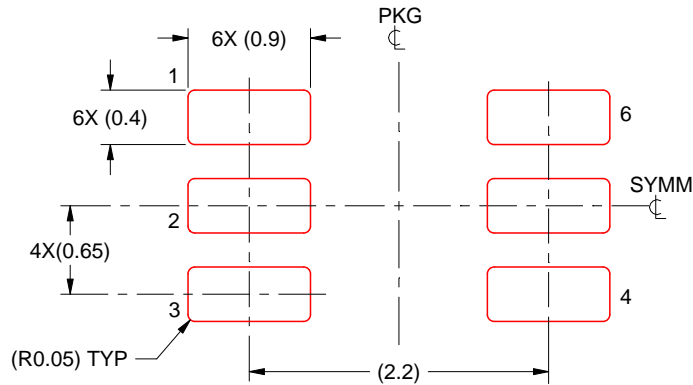

SOLDER PASTE EXAMPLE  
BASED ON 0.125 THICK STENCIL  
SCALE:18X

4214835/D 11/2024

NOTES: (continued)

7. Laser cutting apertures with trapezoidal walls and rounded corners may offer better paste release. IPC-7525 may have alternate design recommendations.
8. Board assembly site may have different recommendations for stencil design.

## 重要なお知らせと免責事項

TI は、技術データと信頼性データ(データシートを含みます)、設計リソース(リファレンス デザインを含みます)、アプリケーションや設計に関する各種アドバイス、Web ツール、安全性情報、その他のリソースを、欠陥が存在する可能性のある「現状のまま」提供しており、商品性および特定目的に対する適合性の黙示保証、第三者の知的財産権の非侵害保証を含むいかなる保証も、明示的または黙示的にかかわらず拒否します。

これらのリソースは、TI 製品を使用する設計の経験を積んだ開発者への提供を意図したものです。(1) お客様のアプリケーションに適した TI 製品の選定、(2) お客様のアプリケーションの設計、検証、試験、(3) お客様のアプリケーションに該当する各種規格や、その他のあらゆる安全性、セキュリティ、規制、または他の要件への確実な適合に関する責任を、お客様のみが単独で負うものとし、

上記の各種リソースは、予告なく変更される可能性があります。これらのリソースは、リソースで説明されている TI 製品を使用するアプリケーションの開発の目的でのみ、TI はその使用をお客様に許諾します。これらのリソースに関して、他の目的で複製することや掲載することは禁止されています。TI や第三者の知的財産権のライセンスが付与されている訳ではありません。お客様は、これらのリソースを自身で使用した結果発生するあらゆる申し立て、損害、費用、損失、責任について、TI およびその代理人を完全に補償するものとし、TI は一切の責任を拒否します。

TI の製品は、[TI の販売条件](#)、[TI の総合的な品質ガイドライン](#)、[ti.com](#) または TI 製品などに関連して提供される他の適用条件に従い提供されます。TI がこれらのリソースを提供することは、適用される TI の保証または他の保証の放棄の拡大や変更を意味するものではありません。TI がカスタム、またはカスタマー仕様として明示的に指定していない限り、TI の製品は標準的なカタログに掲載される汎用機器です。

お客様がいかなる追加条項または代替条項を提案する場合も、TI はそれらに異議を唱え、拒否します。

Copyright © 2025, Texas Instruments Incorporated

最終更新日：2025 年 10 月