

## TLV170x 2.2-V to 36-V, microPower Comparator

### 1 Features

- Supply Range:  
+2.2 V to +36 V or  $\pm 1.1$  V to  $\pm 18$  V
- Low Quiescent Current:  
55  $\mu$ A per Comparator
- Input Common-Mode Range Includes Both Rails
- Low Propagation Delay: 560 ns
- Low Input Offset Voltage: 300  $\mu$ V
- Open Collector Outputs:
  - Up to 36 V Above Negative Supply Regardless of Supply Voltage
- Industrial Temperature Range:  
–40°C to +125°C
- Small Packages:
  - Single: SC70-5, SOT-23-5, SOT553-5
  - Dual: VSSOP-8, X2QFN-8
  - Quad: TSSOP-14

### 2 Applications

- Overvoltage and Undervoltage Detectors
- Window Comparators
- Overcurrent Detectors
- Zero-Crossing Detectors
- System Monitoring for:
  - Power Supplies
  - White Goods
  - Industrial Sensors
  - Automotive
  - Medical

### 3 Description

The TLV170x family of devices offers a wide supply range, rail-to-rail inputs, low quiescent current, and low propagation delay. All these features come in industry-standard, extremely-small packages, making these devices the best general-purpose comparators available.

The open collector output offers the advantage of allowing the output to be pulled to any voltage rail up to +36 V above the negative power supply, regardless of the TLV170x supply voltage.

These devices are available in single (TLV1701), dual (TLV1702), and quad (TLV1704) channel versions. Low input offset voltage, low input bias currents, low supply current, and open-collector configuration make the TLV170x family flexible enough to handle almost any application, from simple voltage detection to driving a single relay.

All devices are specified for operation across the expanded industrial temperature range of –40°C to +125°C.

#### Device Information<sup>(1)</sup>

PART NUMBER	PACKAGE	BODY SIZE (NOM)
TLV1701	SOT553 (5)	1.20 mm x 1.60 mm
	SC-70 (5)	1.25 mm x 2.00 mm
	SOT-23 (5)	1.60 mm x 2.90 mm
TLV1702	X2QFN (8)	1.50 mm x 1.50 mm
	VSSOP (8) <sup>(2)</sup>	3.00 mm x 3.00 mm
TLV1704	TSSOP (14)	4.40 mm x 5.00 mm

(1) For all available packages, see the package option addendum at the end of the datasheet.

(2) The VSSOP package is the same as the MSOP package.

#### TLV1702 as a Window Comparator

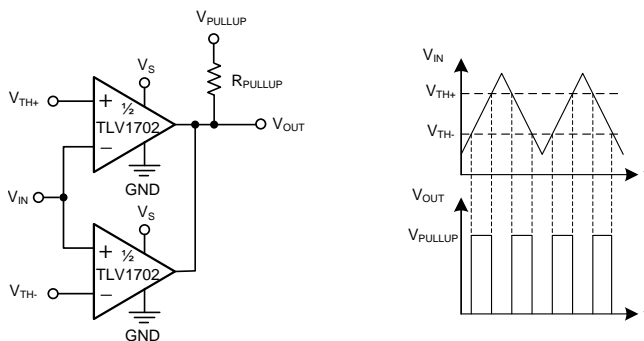

#### Stable Propagation Delay vs Temperature

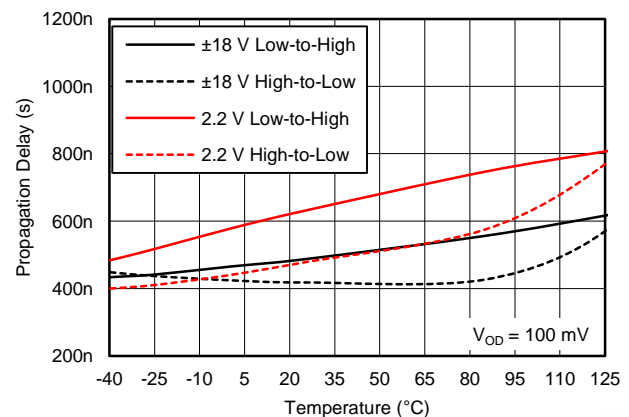

## Table of Contents

<b>1 Features</b> .....	<b>1</b>	8.3 Feature Description .....	<b>12</b>
<b>2 Applications</b> .....	<b>1</b>	8.4 Device Functional Modes .....	<b>12</b>
<b>3 Description</b> .....	<b>1</b>	<b>9 Applications and Implementation</b> .....	<b>13</b>
<b>4 Revision History</b> .....	<b>2</b>	9.1 Application Information .....	<b>13</b>
<b>5 Device Comparison</b> .....	<b>4</b>	9.2 Typical Application .....	<b>13</b>
<b>6 Pin Configuration and Functions</b> .....	<b>5</b>	<b>10 Power Supply Recommendations</b> .....	<b>14</b>
<b>7 Specifications</b> .....	<b>6</b>	<b>11 Layout</b> .....	<b>15</b>
7.1 Absolute Maximum Ratings .....	<b>6</b>	11.1 Layout Guidelines .....	<b>15</b>
7.2 ESD Ratings .....	<b>6</b>	11.2 Layout Example .....	<b>15</b>
7.3 Recommended Operating Conditions .....	<b>6</b>	<b>12 Device and Documentation Support</b> .....	<b>16</b>
7.4 Thermal Information: TLV1701 .....	<b>6</b>	12.1 Documentation Support .....	<b>16</b>
7.5 Thermal Information: TLV1702 and TLV1704 .....	<b>7</b>	12.2 Related Links .....	<b>16</b>
7.6 Electrical Characteristics .....	<b>7</b>	12.3 Community Resources .....	<b>16</b>
7.7 Switching Characteristics .....	<b>7</b>	12.4 Trademarks .....	<b>16</b>
7.8 Typical Characteristics .....	<b>8</b>	12.5 Electrostatic Discharge Caution .....	<b>16</b>
<b>8 Detailed Description</b> .....	<b>11</b>	12.6 Glossary .....	<b>16</b>
8.1 Overview .....	<b>11</b>	<b>13 Mechanical, Packaging, and Orderable Information</b> .....	<b>16</b>
8.2 Functional Block Diagram .....	<b>11</b>		

## 4 Revision History

NOTE: Page numbers for previous revisions may differ from page numbers in the current version.

<b>Changes from Revision C (December 2014) to Revision D</b>	<b>Page</b>
• Changed document status to Production Data from Mixed Status .....	<b>1</b>
• Changed status of TLV1702 RUG package to Production Data .....	<b>1</b>

<b>Changes from Revision B (October 2014) to Revision C</b>	<b>Page</b>
• Changed TLV1701 DCK package from preview to production data .....	<b>1</b>
• Changed Handling Ratings table to ESD Ratings table, and moved storage temperature to Absolute Maximum Ratings table .....	<b>6</b>

<b>Changes from Revision A (September 2014) to Revision B</b>	<b>Page</b>
• Changed footnote 2 in Device Information table: added TLV1701 to list of available devices .....	<b>1</b>
• Added TLV1701 to list of production data packages in footnote for the <i>Pin Configuration and Functions</i> section .....	<b>5</b>
• Added TLV1701 row to $V_{(ESD)}$ parameter in Handling Ratings table .....	<b>6</b>

<b>Changes from Original (December 2013) to Revision A</b>	<b>Page</b>
• Changed document format to latest data sheet standards; added new sections and moved existing sections .....	1
• Changed TLV1704 PW (TSSOP-14) package from preview to production data .....	1
• Added sub-bullet to the Open Collector Outputs feature .....	1
• Added second paragraph to the <i>Description</i> section.....	1
• Deleted package information from <i>Description</i> section; redundant information .....	1
• Changed Related Products table to Device Comparison table, moved from page 1, and added TLV370x family.....	4
• Added TLV1701, TLV1702 RUG, and TLV704 package drawings .....	5
• Added thermal information for TLV1702 RUG, TLV1704 PW, and all TLV1701 packages .....	6
• Moved switching characteristics parameters from Electrical Characteristics table to new <i>Switching Characteristics</i> table ..	7
• Changed all typical values in <i>Switching Characteristics</i> table.....	7
• Changed title for <i>Figure 1</i> .....	8
• Changed <i>Figure 8</i> .....	8
• Changed <i>Figure 9</i> .....	8
• Changed <i>Figure 10</i> .....	8
• Changed <i>Figure 11</i> .....	8
• Changed <i>Figure 12</i> .....	8
• Changed <i>Figure 13</i> .....	9
• Changed <i>Figure 14</i> .....	9
• Changed <i>Application Information</i> and moved section .....	13
• Deleted <i>Application Examples</i> section .....	13

## 5 Device Comparison

DEVICE	FEATURES
<a href="#">TLV3201</a>	40-ns, 40- $\mu$ A, push-pull comparator
<a href="#">TLV3202</a>	
<a href="#">TLV3501</a>	4.5-ns, rail-to-rail, push-pull, high-speed comparator
<a href="#">TLV3502</a>	
<a href="#">TLV3401</a>	Nanopower open-drain output comparator
<a href="#">TLV3402</a>	
<a href="#">TLV3404</a>	
<a href="#">TLV3701</a>	Nanopower push-pull output comparator
<a href="#">TLV3702</a>	
<a href="#">TLV3704</a>	
<a href="#">REF3325</a>	3.9- $\mu$ A, SC70-3 voltage reference
<a href="#">REF3330</a>	
<a href="#">REF3333</a>	

## 6 Pin Configuration and Functions

**TLV1701**  
DBV (SOT-23-5), DCK (SC70-5), DRL (SOT553-5) Packages  
Top View

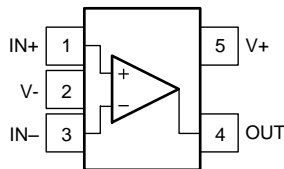

**TLV1702**  
RUG (X2QFN-8) Package  
Top View

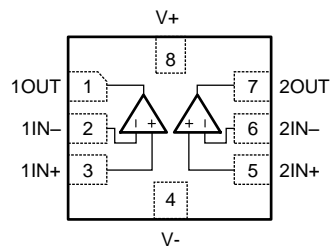

**TLV1702**  
DGK (VSSOP-8) Package  
Top View

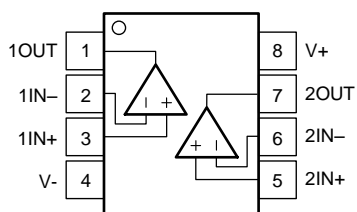

**TLV1704**  
PW (TSSOP-14) Package  
Top View

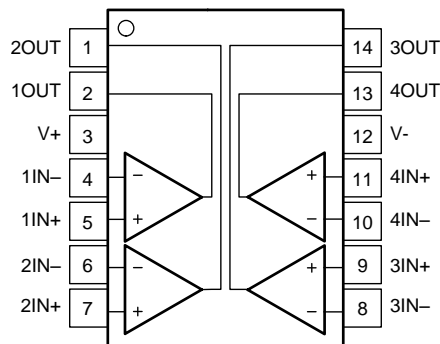

### Pin Functions

NAME	PIN NO.			I/O	DESCRIPTION
	TLV1701 DBV, DCK, DRL	TLV1702 DGK, RUG	TLV1704 PW		
IN+	1	—	—	I	Noninverting input
1IN+	—	3	5	I	Noninverting input, channel 1
2IN+	—	5	7	I	Noninverting input, channel 2
3IN+	—	—	9	I	Noninverting input, channel 3
4IN+	—	—	11	I	Noninverting input, channel 4
IN-	3	—	—	I	Inverting input
1IN-	—	2	4	I	Inverting input, channel 1
2IN-	—	6	6	I	Inverting input, channel 2
3IN-	—	—	8	I	Inverting input, channel 3
4IN-	—	—	10	I	Inverting input, channel 4
OUT	4	—	—	O	Output
1OUT	—	1	2	O	Output, channel 1
2OUT	—	7	1	O	Output, channel 2
3OUT	—	—	14	O	Output, channel 3
4OUT	—	—	13	O	Output, channel 4
V+	5	8	3	—	Positive (highest) power supply
V-	2	4	12	—	Negative (lowest) power supply

## 7 Specifications

### 7.1 Absolute Maximum Ratings<sup>(1)</sup>

over operating free-air temperature range (unless otherwise noted)

		MIN	MAX	UNIT
Supply voltage		+40 (±20)		V
Signal input pins	Voltage <sup>(2)</sup>	(V <sub>S-</sub> ) – 0.5	(V <sub>S+</sub> ) + 0.5	V
	Current <sup>(2)</sup>	±10		mA
Output short-circuit <sup>(3)</sup>		Continuous		mA
Operating temperature range		–55	+150	°C
Junction temperature, T <sub>J</sub>		150		°C
Storage temperature, T <sub>stg</sub>		–65	+150	°C

- Stresses beyond those listed under absolute maximum ratings may cause permanent damage to the device. These are stress ratings only, and functional operation of the device at these or any other conditions beyond those indicated under recommended operating conditions is not implied. Exposure to absolute-maximum-rated conditions for extended periods may affect device reliability.
- Input pins are diode-clamped to the power-supply rails. Input signals that can swing more than 0.5 V beyond the supply rails must be current limited to 10 mA or less.
- Short-circuit to ground; one comparator per package.

### 7.2 ESD Ratings

			VALUE	UNIT
TLV1701 and TLV1702				
V <sub>(ESD)</sub>	Electrostatic discharge	Human-body model (HBM), per ANSI/ESDA/JEDEC JS-001 <sup>(1)</sup>	±2000	V
		Charged-device model (CDM), per JEDEC specification JESD22-C101 <sup>(2)</sup>	±1500	
TLV1704				
V <sub>(ESD)</sub>	Electrostatic discharge	Human-body model (HBM), per ANSI/ESDA/JEDEC JS-001 <sup>(1)</sup>	±1000	V
		Charged-device model (CDM), per JEDEC specification JESD22-C101 <sup>(2)</sup>	±1500	

- JEDEC document JEP155 states that 500-V HBM allows safe manufacturing with a standard ESD control process.
- JEDEC document JEP157 states that 250-V CDM allows safe manufacturing with a standard ESD control process.

### 7.3 Recommended Operating Conditions

over operating free-air temperature range (unless otherwise noted)

	MIN	NOM	MAX	UNIT
Supply voltage V <sub>S</sub> = (V <sub>S+</sub> ) – (V <sub>S-</sub> )	2.2 (±1.1)		36 (±18)	V
Specified temperature	–40		125	°C

### 7.4 Thermal Information: TLV1701

THERMAL METRIC <sup>(1)</sup>	TLV1701			UNIT
	DRL (SOT553)	DCK (SC70)	DBV (SOT23)	
	5 PINS	5 PINS	5 PINS	
R <sub>θJA</sub> Junction-to-ambient thermal resistance	271.5	283.6	233.1	°C/W
R <sub>θJC(top)</sub> Junction-to-case (top) thermal resistance	115.6	94.1	156.4	°C/W
R <sub>θJB</sub> Junction-to-board thermal resistance	89.7	61.3	60.6	°C/W
ψ <sub>JT</sub> Junction-to-top characterization parameter	17.6	1.9	35.7	°C/W
ψ <sub>JB</sub> Junction-to-board characterization parameter	89.2	60.5	59.7	°C/W
R <sub>θJC(bot)</sub> Junction-to-case (bottom) thermal resistance	N/A	N/A	N/A	°C/W

- For more information about traditional and new thermal metrics, see the *Semiconductor and IC Package Thermal Metrics* application report, [SPRA953](#).

## 7.5 Thermal Information: TLV1702 and TLV1704

THERMAL METRIC <sup>(1)</sup>		TLV1702		TLV1704	UNIT
		RUG (QFN)	DGK (VSSOP)	PW (TSSOP)	
		8 PINS	8 PINS	14 PINS	
$\theta_{JA}$	Junction-to-ambient thermal resistance	205.6	199	128.1	°C/W
$\theta_{JCTop}$	Junction-to-case (top) thermal resistance	77.1	89.5	56.5	°C/W
$\theta_{JB}$	Junction-to-board thermal resistance	107.0	120.4	69.9	°C/W
$\psi_{JT}$	Junction-to-top characterization parameter	2.0	22.0	9.1	°C/W
$\psi_{JB}$	Junction-to-board characterization parameter	107.0	118.7	69.3	°C/W
$\theta_{JCbott}$	Junction-to-case (bottom) thermal resistance	N/A	N/A	N/A	°C/W

(1) For more information about traditional and new thermal metrics, see the *Semiconductor and IC Package Thermal Metrics* application report, [SPRA953](#).

## 7.6 Electrical Characteristics

at  $T_A = +25^\circ\text{C}$ ,  $V_S = +2.2\text{ V to }+36\text{ V}$ ,  $C_L = 15\text{ pF}$ ,  $R_{PULLUP} = 5.1\text{ k}\Omega$ ,  $V_{CM} = V_S / 2$ , and  $V_S = V_{PULLUP}$  (unless otherwise noted)

PARAMETER	TEST CONDITIONS	MIN	TYP	MAX	UNIT	
<b>OFFSET VOLTAGE</b>						
$V_{OS}$	Input offset voltage	$T_A = 25^\circ\text{C}$ , $V_S = 2.2\text{ V}$		$\pm 0.5$	$\pm 3.5$	mV
		$T_A = 25^\circ\text{C}$ , $V_S = 36\text{ V}$		$\pm 0.3$	$\pm 2.5$	mV
		$T_A = -40^\circ\text{C to }+125^\circ\text{C}$			$\pm 5.5$	mV
$dV_{OS}/dT$	Input offset voltage drift	$T_A = -40^\circ\text{C to }+125^\circ\text{C}$		$\pm 4$	$\pm 20$	$\mu\text{V}/^\circ\text{C}$
PSRR	Power-supply rejection ratio			15	100	$\mu\text{V}/\text{V}$
		$T_A = -40^\circ\text{C to }+125^\circ\text{C}$		20		$\mu\text{V}/\text{V}$
<b>INPUT VOLTAGE RANGE</b>						
$V_{CM}$	Common-mode voltage range	$T_A = -40^\circ\text{C to }+125^\circ\text{C}$		(V-)	(V+)	V
<b>INPUT BIAS CURRENT</b>						
$I_B$	Input bias current			5	15	nA
		$T_A = -40^\circ\text{C to }+125^\circ\text{C}$			20	nA
$I_{OS}$	Input offset current			0.5		nA
$C_{LOAD}$	Capacitive load drive	See <a href="#">Typical Characteristics</a>				
<b>OUTPUT</b>						
$V_O$	Voltage output swing from rail	$I_O \leq 4\text{ mA}$ , input overdrive = 100 mV, $V_S = 36\text{ V}$			900	mV
		$I_O = 0\text{ mA}$ , input overdrive = 100 mV, $V_S = 36\text{ V}$			600	mV
$I_{SC}$	Short circuit sink current			20		mA
	Output leakage current	$V_{IN+} > V_{IN-}$		70		nA
<b>POWER SUPPLY</b>						
$V_S$	Specified voltage range			2.2	36	V
$I_Q$	Quiescent current (per channel)	$I_O = 0\text{ A}$		55	75	$\mu\text{A}$
		$I_O = 0\text{ A}$ , $T_A = -40^\circ\text{C to }+125^\circ\text{C}$			100	$\mu\text{A}$

## 7.7 Switching Characteristics

at  $T_A = +25^\circ\text{C}$ ,  $V_S = +2.2\text{ V to }+36\text{ V}$ ,  $C_L = 15\text{ pF}$ ,  $R_{PULLUP} = 5.1\text{ k}\Omega$ ,  $V_{CM} = V_S / 2$ , and  $V_S = V_{PULLUP}$  (unless otherwise noted)

PARAMETER	TEST CONDITIONS	MIN	TYP	MAX	UNIT
$t_{pHL}$	Propagation delay time, high-to-low	Input overdrive = 100 mV		460	ns
$t_{pLH}$	Propagation delay time, low-to-high	Input overdrive = 100 mV		560	ns
$t_R$	Rise time	Input overdrive = 100 mV		365	ns
$t_F$	Fall time	Input overdrive = 100 mV		240	ns

## 7.8 Typical Characteristics

at  $T_A = +25^\circ\text{C}$ ,  $V_S = +5\text{ V}$ ,  $R_{\text{PULLUP}} = 5.1\text{ k}\Omega$ , and input overdrive = 100 mV (unless otherwise noted)

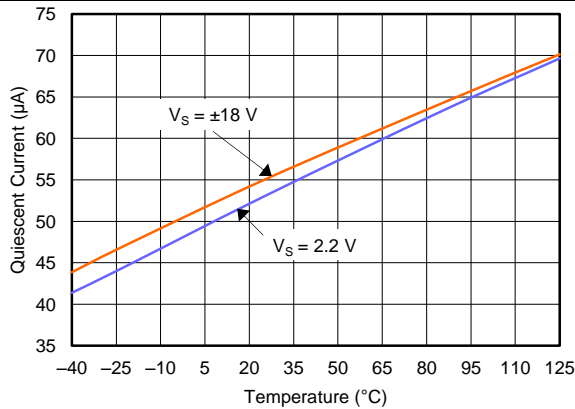

Figure 1. Quiescent Current vs Temperature

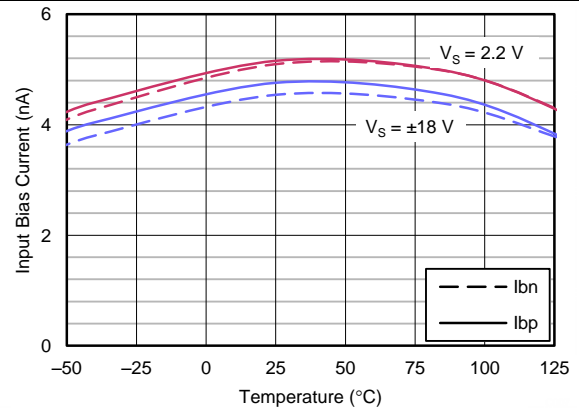

Figure 2. Input Bias Current vs Temperature

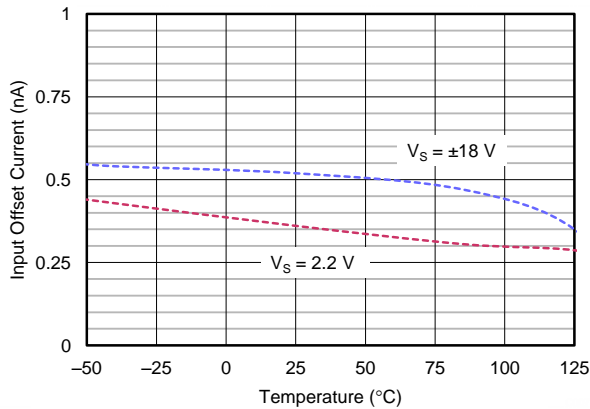

Figure 3. Input Offset Current vs Temperature

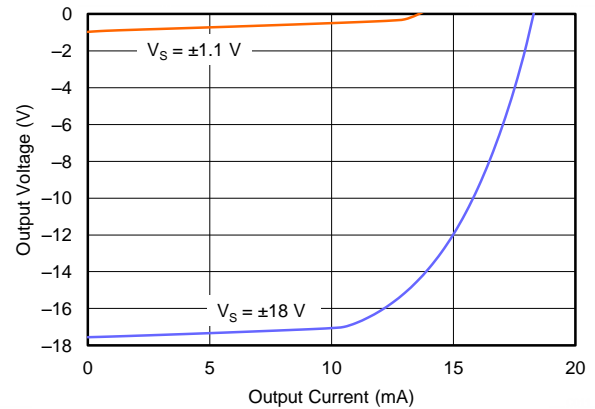

Figure 4. Output Voltage vs Output Current

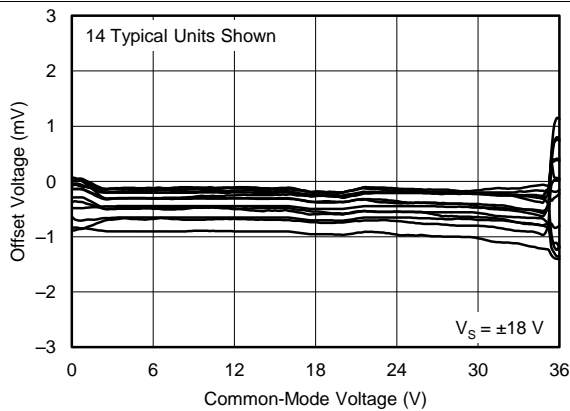

Figure 5. Offset Voltage vs Common-Mode Voltage

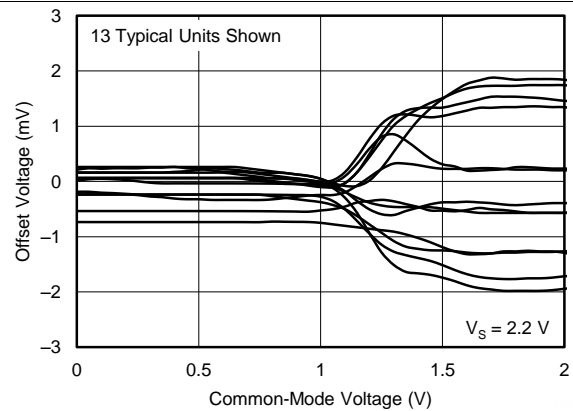

Figure 6. Offset Voltage vs Common-Mode Voltage



Typical Characteristics (continued)

at  $T_A = +25^\circ\text{C}$ ,  $V_S = +5\text{ V}$ ,  $R_{\text{PULLUP}} = 5.1\text{ k}\Omega$ , and input overdrive = 100 mV (unless otherwise noted)

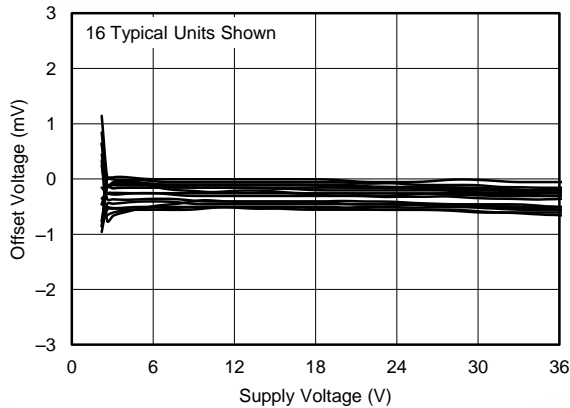

Figure 7. Offset Voltage vs Supply Voltage

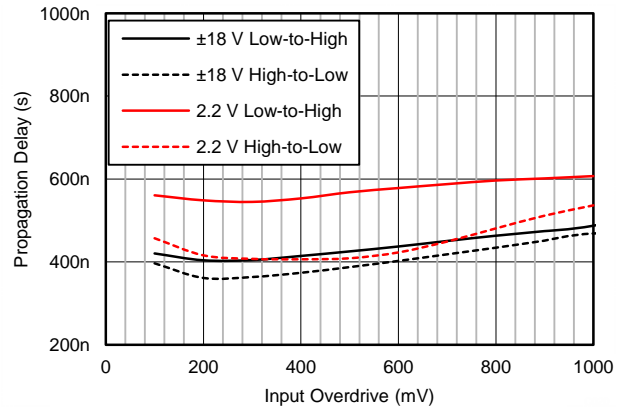

Figure 8. Propagation Delay vs Input Overdrive

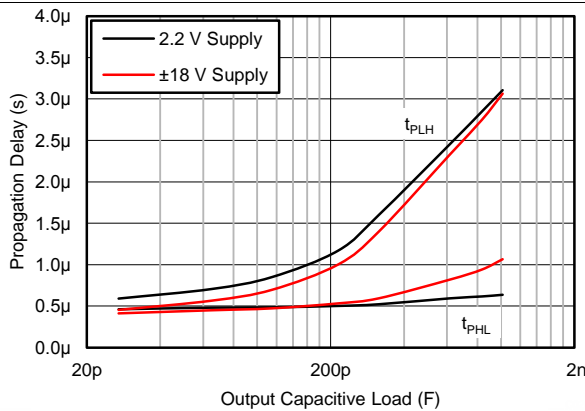

Figure 9. Propagation Delay vs Capacitive Load

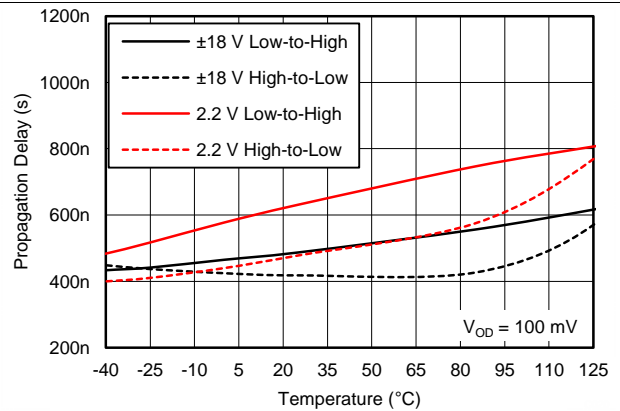

Figure 10. Propagation Delay vs Temperature

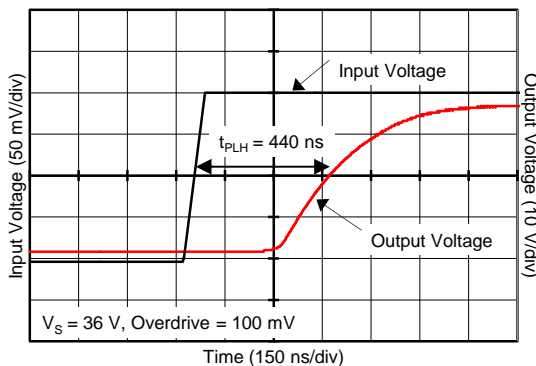

Figure 11. Propagation Delay ( $T_{\text{PLH}}$ )

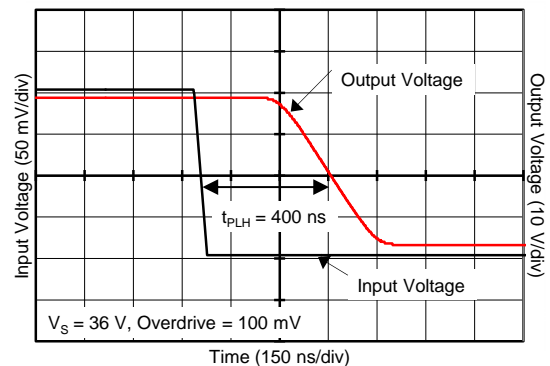
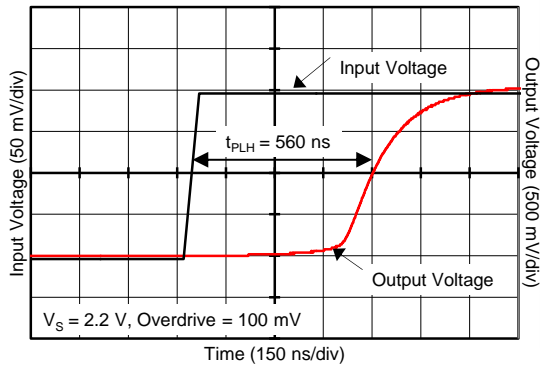

Figure 12. Propagation Delay ( $T_{\text{PHL}}$ )

**Typical Characteristics (continued)**

at  $T_A = +25^\circ\text{C}$ ,  $V_S = +5\text{ V}$ ,  $R_{\text{PULLUP}} = 5.1\text{ k}\Omega$ , and input overdrive = 100 mV (unless otherwise noted)



**Figure 13. Propagation Delay ( $T_{\text{pLH}}$ )**

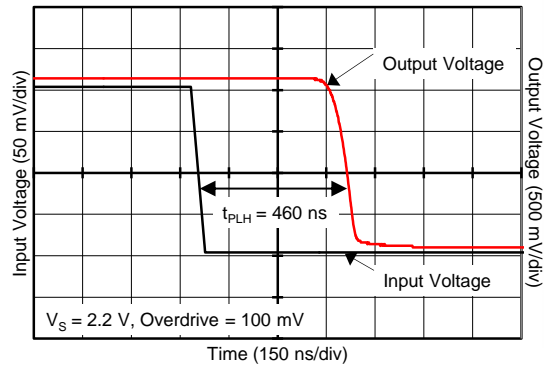

**Figure 14. Propagation Delay ( $T_{\text{pHL}}$ )**

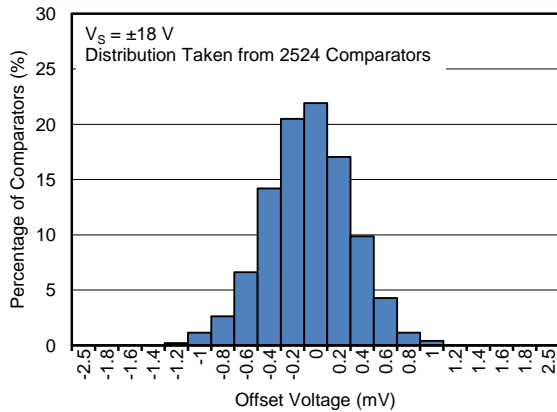

**Figure 15. Offset Voltage Production Distribution**

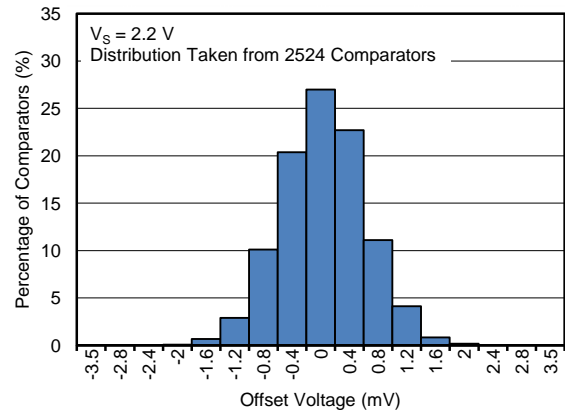

**Figure 16. Offset Voltage Production Distribution**

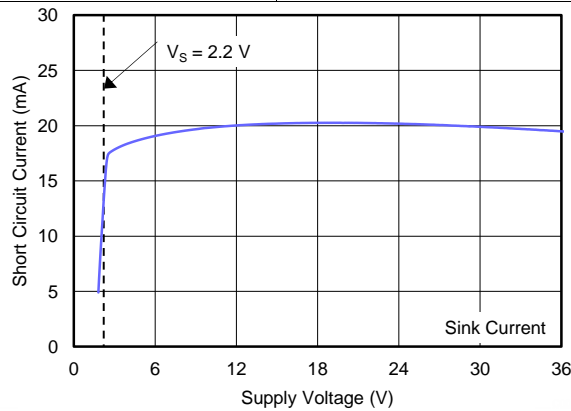

**Figure 17. Short-Circuit Current vs Supply Voltage**

## 8 Detailed Description

### 8.1 Overview

The TLV170x comparators features rail-to-rail input and output on supply voltages as high as 36 V. The rail-to-rail input stage enables detection of signals close to the supply and ground. The open collector configuration allows the device to be used in wired-OR configurations, such as a window comparator. A low supply current of 55  $\mu\text{A}$  per channel with small, space-saving packages, makes these comparators versatile for use in a wide range of applications, from portable to industrial.

### 8.2 Functional Block Diagram

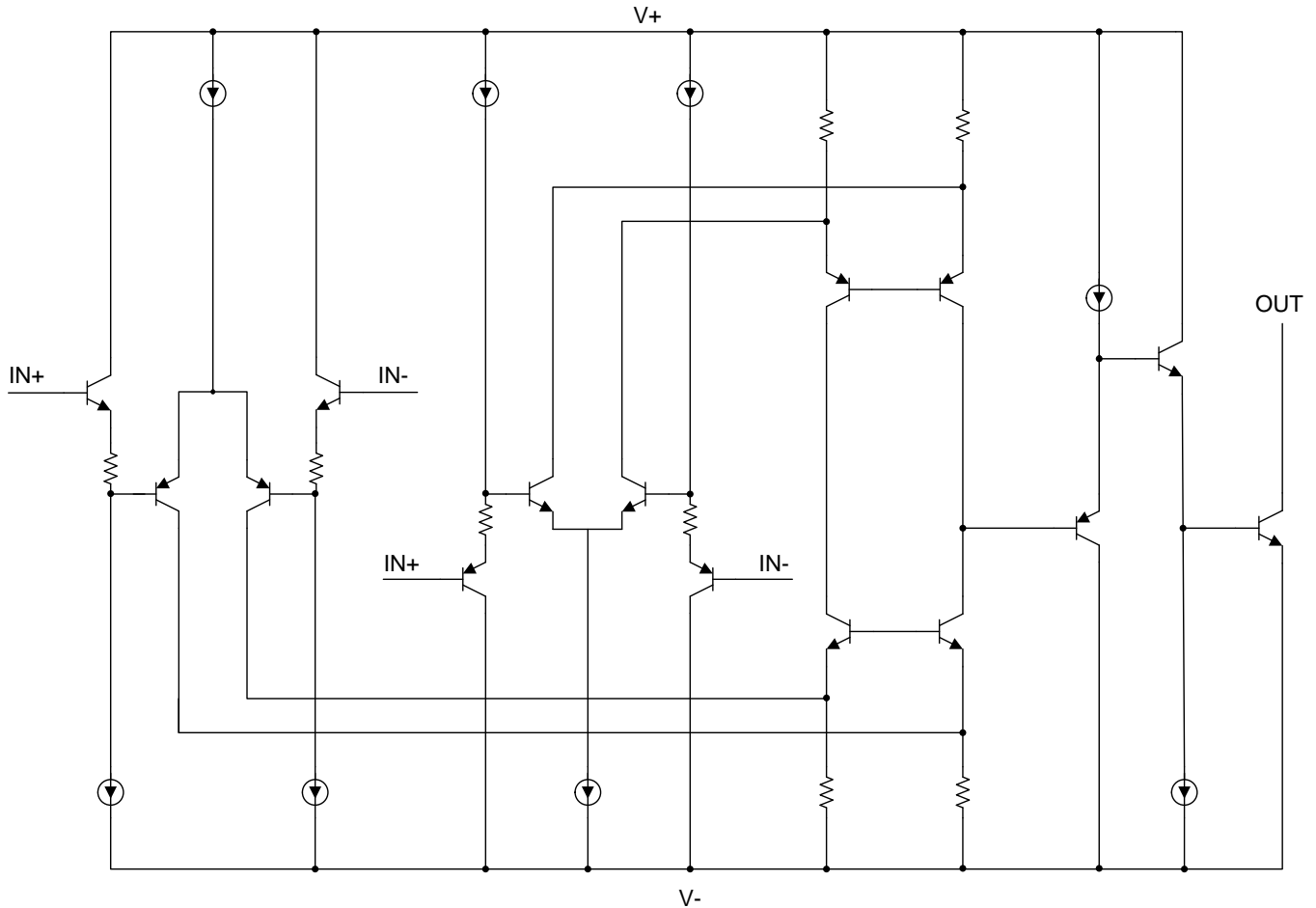

## 8.3 Feature Description

### 8.3.1 Comparator Inputs

The TLV170x are rail-to-rail input comparators, with an input common-mode range that includes the supply rails. The TLV170x is designed to prevent phase inversion when the input pins exceed the supply voltage. Figure 18 shows the TLV170x response when input voltages exceed the supply, resulting in no phase inversion.

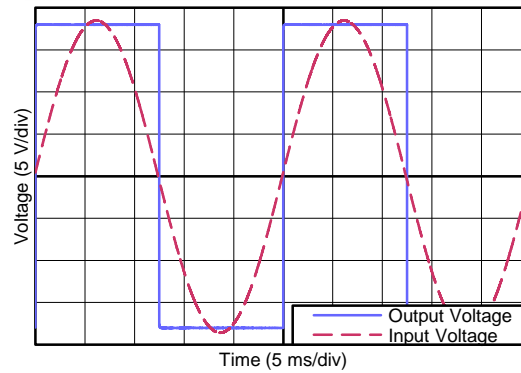
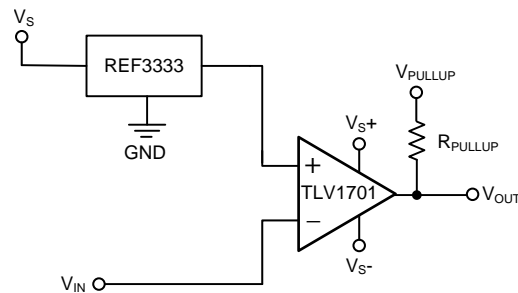

**Figure 18. No Phase Inversion: Comparator Response to Input Voltage (Propagation Delay Included)**

## 8.4 Device Functional Modes

### 8.4.1 Setting Reference Voltage

Using a stable reference is important when setting the transition point for the TLV170x. The REF3333, as shown in Figure 19, provides a 3.3-V reference voltage with low drift and only 3.9  $\mu\text{A}$  of quiescent current.



**Figure 19. Reference Voltage for the TLV170x**

## 9 Applications and Implementation

### NOTE

Information in the following applications sections is not part of the TI component specification, and TI does not warrant its accuracy or completeness. TI's customers are responsible for determining suitability of components for their purposes. Customers should validate and test their design implementation to confirm system functionality.

### 9.1 Application Information

The TLV170x can be used in a wide variety of applications, such as zero crossing detectors, window comparators, over and undervoltage detectors, and high-side voltage sense circuits.

### 9.2 Typical Application

Comparators are used to differentiate between two different signal levels. For example, a comparator differentiates between an overtemperature and normal-temperature condition. However, noise or signal variation at the comparison threshold causes multiple transitions. This application example sets upper and lower hysteresis thresholds to eliminate the multiple transitions caused by noise.

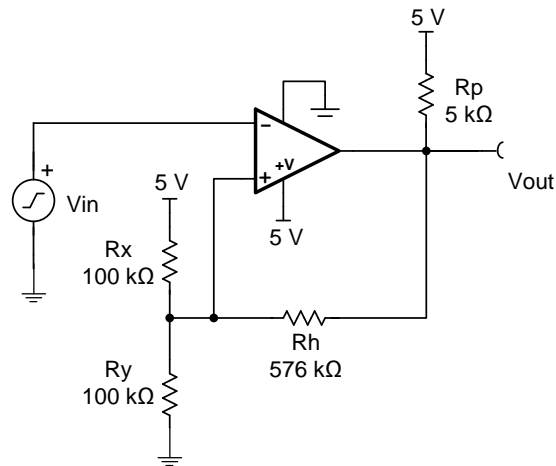

**Figure 20. Comparator Schematic with Hysteresis**

#### 9.2.1 Design Requirements

The design requirements are as follows:

- Supply voltage: 5 V
- Input: 0 V to 5 V
- Lower threshold (VL) = 2.3 V ±0.1 V
- Upper threshold (VH) = 2.7 V ±0.1 V
- VH – VL = 2.4 V ±0.1 V
- Low power consumption

## Typical Application (continued)

### 9.2.2 Detailed Design Procedure

Make a small change to the comparator circuit to add hysteresis. Hysteresis uses two different threshold voltages to avoid the multiple transitions introduced in the previous circuit. The input signal must exceed the upper threshold (VH) to transition low, or below the lower threshold (VL) to transition high.

**Figure 20** illustrates hysteresis on a comparator. Resistor Rh sets the hysteresis level. An open-collector output stage requires a pullup resistor (Rp). The pullup resistor creates a voltage divider at the comparator output that introduces an error when the output is at logic high. This error can be minimized if  $R_h > 100R_p$ .

When the output is at a logic high (5 V), Rh is in parallel with Rx (ignoring Rp). This configuration drives more current into Ry, and raises the threshold voltage (VH) to 2.7 V. The input signal must drive above  $V_H = 2.7$  V to cause the output to transition to logic low (0 V).

When the output is at logic low (0 V), Rh is in parallel with Ry. This configuration reduces the current into Ry, and reduces the threshold voltage to 2.3 V. The input signal must drive below  $V_L = 2.3$  V to cause the output to transition to logic high (5 V).

For more details on this design and other alternative devices that can be used in place of the TLV1702, refer to Precision Design [TIPD144](#), *Comparator with Hysteresis Reference Design*.

### 9.2.3 Application Curve

**Figure 21** shows the upper and lower thresholds for hysteresis. The upper threshold is 2.76 V and the lower threshold is 2.34 V, both of which are close to the design target.

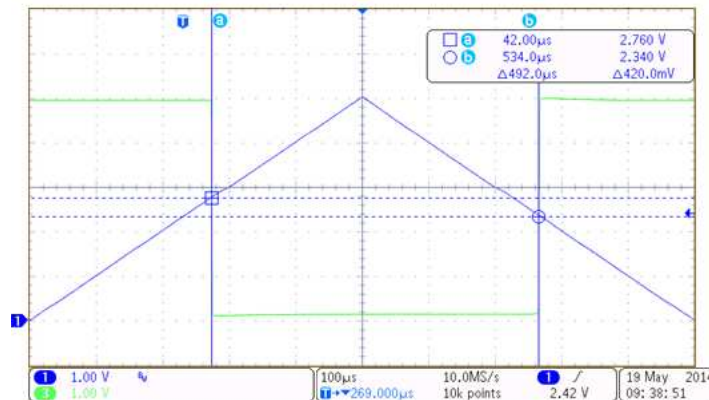

**Figure 21. TLV1701 Upper and Lower Threshold with Hysteresis**

## 10 Power Supply Recommendations

The TLV170x is specified for operation from 2.2 V to 36 V ( $\pm 1.1$  to  $\pm 18$  V); many specifications apply from  $-40^\circ\text{C}$  to  $+125^\circ\text{C}$ . Parameters that can exhibit significant variance with regard to operating voltage or temperature are presented in the [Typical Characteristics](#) section.

### CAUTION

Supply voltages larger than 40 V can permanently damage the device; see the [Absolute Maximum Ratings](#).

Place 0.1- $\mu\text{F}$  bypass capacitors close to the power-supply pins to reduce errors coupling in from noisy or high-impedance power supplies. For more detailed information on bypass capacitor placement; see the [Layout Guidelines](#) section.

## 11 Layout

### 11.1 Layout Guidelines

Comparators are very sensitive to input noise. For best results, maintain the following layout guidelines:

- Use a printed circuit board (PCB) with a good, unbroken low-inductance ground plane. Proper grounding (use of ground plane) helps maintain specified performance of the TLV170x.
- To minimize supply noise, place a decoupling capacitor (0.1- $\mu$ F ceramic, surface-mount capacitor) as close as possible to  $V_S$  as shown in [Figure 22](#).
- On the inputs and the output, keep lead lengths as short as possible to avoid unwanted parasitic feedback around the comparator. Keep inputs away from the output.
- Solder the device directly to the PCB rather than using a socket.
- For slow-moving input signals, take care to prevent parasitic feedback. A small capacitor (1000 pF or less) placed between the inputs can help eliminate oscillations in the transition region. This capacitor causes some degradation to propagation delay when the impedance is low. Run the topside ground plane between the output and inputs.
- Run the ground pin ground trace under the device up to the bypass capacitor, shielding the inputs from the outputs.

### 11.2 Layout Example

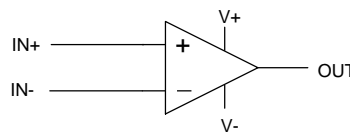

(Schematic Representation)

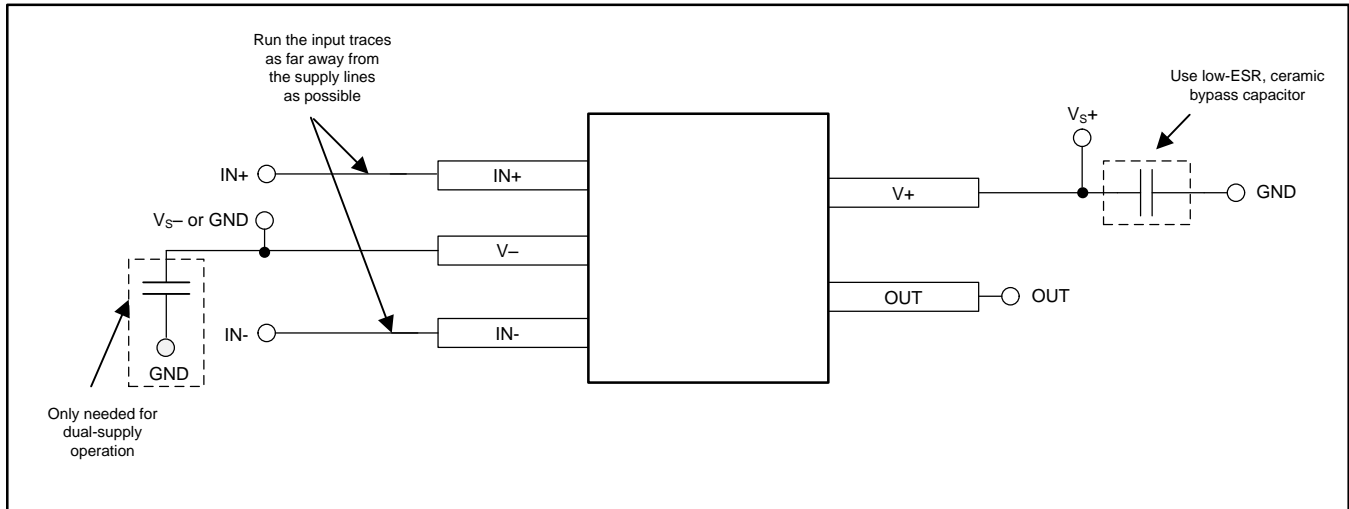

**Figure 22. Comparator Board Layout**

## 12 Device and Documentation Support

### 12.1 Documentation Support

#### 12.1.1 Related Documentation

[TIDU020](#) — *Precision Design, Comparator with Hysteresis Reference Design.*

[SBOS392](#) — REF3333 Data Sheet

### 12.2 Related Links

**Table 1** lists quick access links. Categories include technical documents, support and community resources, tools and software, and quick access to sample or buy.

**Table 1. Related Links**

PARTS	PRODUCT FOLDER	SAMPLE & BUY	TECHNICAL DOCUMENTS	TOOLS & SOFTWARE	SUPPORT & COMMUNITY
TLV1701	<a href="#">Click here</a>	<a href="#">Click here</a>	<a href="#">Click here</a>	<a href="#">Click here</a>	<a href="#">Click here</a>
TLV1702	<a href="#">Click here</a>	<a href="#">Click here</a>	<a href="#">Click here</a>	<a href="#">Click here</a>	<a href="#">Click here</a>
TLV1704	<a href="#">Click here</a>	<a href="#">Click here</a>	<a href="#">Click here</a>	<a href="#">Click here</a>	<a href="#">Click here</a>

### 12.3 Community Resources

The following links connect to TI community resources. Linked contents are provided "AS IS" by the respective contributors. They do not constitute TI specifications and do not necessarily reflect TI's views; see TI's [Terms of Use](#).

**TI E2E™ Online Community** *TI's Engineer-to-Engineer (E2E) Community.* Created to foster collaboration among engineers. At [e2e.ti.com](http://e2e.ti.com), you can ask questions, share knowledge, explore ideas and help solve problems with fellow engineers.

**Design Support** *TI's Design Support* Quickly find helpful E2E forums along with design support tools and contact information for technical support.

### 12.4 Trademarks

E2E is a trademark of Texas Instruments.  
All other trademarks are the property of their respective owners.

### 12.5 Electrostatic Discharge Caution



This integrated circuit can be damaged by ESD. Texas Instruments recommends that all integrated circuits be handled with appropriate precautions. Failure to observe proper handling and installation procedures can cause damage.

ESD damage can range from subtle performance degradation to complete device failure. Precision integrated circuits may be more susceptible to damage because very small parametric changes could cause the device not to meet its published specifications.

### 12.6 Glossary

[SLYZ022](#) — *TI Glossary.*

This glossary lists and explains terms, acronyms, and definitions.

## 13 Mechanical, Packaging, and Orderable Information

The following pages include mechanical packaging and orderable information. This information is the most current data available for the designated devices. This data is subject to change without notice and revision of this document. For browser-based versions of this data sheet, refer to the left-hand navigation.



**PACKAGING INFORMATION**

Orderable part number	Status (1)	Material type (2)	Package   Pins	Package qty   Carrier	RoHS (3)	Lead finish/ Ball material (4)	MSL rating/ Peak reflow (5)	Op temp (°C)	Part marking (6)
<a href="#">TLV1701AIDBVR</a>	Active	Production	SOT-23 (DBV)   5	3000   LARGE T&R	Yes	NIPDAU   SN	Level-1-260C-UNLIM	-40 to 125	ZAYF
TLV1701AIDBVR.B	Active	Production	SOT-23 (DBV)   5	3000   LARGE T&R	Yes	NIPDAU	Level-1-260C-UNLIM	-40 to 125	ZAYF
TLV1701AIDBVRG4.B	Active	Production	SOT-23 (DBV)   5	3000   LARGE T&R	-	Call TI	Call TI	-40 to 125	ZAYF
<a href="#">TLV1701AIDBVT</a>	Active	Production	SOT-23 (DBV)   5	250   SMALL T&R	Yes	NIPDAU   SN	Level-1-260C-UNLIM	-40 to 125	ZAYF
TLV1701AIDBVT.B	Active	Production	SOT-23 (DBV)   5	250   SMALL T&R	Yes	NIPDAU	Level-1-260C-UNLIM	-40 to 125	ZAYF
<a href="#">TLV1701AIDCKR</a>	Active	Production	SC70 (DCK)   5	3000   LARGE T&R	Yes	NIPDAU   SN	Level-2-260C-1 YEAR	-40 to 125	(CD5, SIR)
TLV1701AIDCKR.B	Active	Production	SC70 (DCK)   5	3000   LARGE T&R	Yes	NIPDAU	Level-2-260C-1 YEAR	-40 to 125	(CD5, SIR)
<a href="#">TLV1701AIDCKRG4</a>	Active	Production	SC70 (DCK)   5	3000   LARGE T&R	Yes	NIPDAU	Level-2-260C-1 YEAR	-40 to 125	SIR
TLV1701AIDCKRG4.B	Active	Production	SC70 (DCK)   5	3000   LARGE T&R	Yes	NIPDAU	Level-2-260C-1 YEAR	-40 to 125	SIR
<a href="#">TLV1701AIDCKT</a>	Active	Production	SC70 (DCK)   5	250   SMALL T&R	Yes	NIPDAU   SN	Level-2-260C-1 YEAR	-40 to 125	SIR
TLV1701AIDCKT.B	Active	Production	SC70 (DCK)   5	250   SMALL T&R	Yes	NIPDAU	Level-2-260C-1 YEAR	-40 to 125	SIR
<a href="#">TLV1701AIDRLR</a>	Active	Production	SOT-5X3 (DRL)   5	4000   LARGE T&R	Yes	NIPDAUAG	Level-1-260C-UNLIM	-40 to 125	SIS
TLV1701AIDRLR.B	Active	Production	SOT-5X3 (DRL)   5	4000   LARGE T&R	Yes	NIPDAUAG	Level-1-260C-UNLIM	-40 to 125	SIS
<a href="#">TLV1701AIDRLT</a>	Active	Production	SOT-5X3 (DRL)   5	250   SMALL T&R	Yes	NIPDAUAG	Level-1-260C-UNLIM	-40 to 125	SIS
TLV1701AIDRLT.B	Active	Production	SOT-5X3 (DRL)   5	250   SMALL T&R	Yes	NIPDAUAG	Level-1-260C-UNLIM	-40 to 125	SIS
<a href="#">TLV1702AIDGK</a>	Active	Production	VSSOP (DGK)   8	80   TUBE	Yes	NIPDAUAG	Level-1-260C-UNLIM	-40 to 125	1702
TLV1702AIDGK.B	Active	Production	VSSOP (DGK)   8	80   TUBE	Yes	NIPDAUAG	Level-1-260C-UNLIM	-40 to 125	1702
<a href="#">TLV1702AIDGKR</a>	Active	Production	VSSOP (DGK)   8	2500   LARGE T&R	Yes	NIPDAU   SN   NIPDAUAG	Level-1-260C-UNLIM	-40 to 125	1702
TLV1702AIDGKR.B	Active	Production	VSSOP (DGK)   8	2500   LARGE T&R	Yes	NIPDAU	Level-1-260C-UNLIM	-40 to 125	1702
TLV1702AIDGKRG4	Active	Production	VSSOP (DGK)   8	2500   LARGE T&R	Yes	NIPDAU	Level-1-260C-UNLIM	-40 to 125	1702
TLV1702AIDGKRG4.B	Active	Production	VSSOP (DGK)   8	2500   LARGE T&R	Yes	NIPDAU	Level-1-260C-UNLIM	-40 to 125	1702
<a href="#">TLV1702AIRUGR</a>	Active	Production	X2QFN (RUG)   8	3000   LARGE T&R	Yes	Call TI   Nipdauag	Level-1-260C-UNLIM	-40 to 125	FC
TLV1702AIRUGR.B	Active	Production	X2QFN (RUG)   8	3000   LARGE T&R	Yes	NIPDAUAG	Level-1-260C-UNLIM	-40 to 125	FC
<a href="#">TLV1704AIPW</a>	Active	Production	TSSOP (PW)   14	90   TUBE	Yes	NIPDAU	Level-2-260C-1 YEAR	-40 to 125	TL1704
TLV1704AIPW.B	Active	Production	TSSOP (PW)   14	90   TUBE	Yes	NIPDAU	Level-2-260C-1 YEAR	-40 to 125	TL1704
<a href="#">TLV1704AIPWR</a>	Active	Production	TSSOP (PW)   14	2000   LARGE T&R	Yes	NIPDAU	Level-2-260C-1 YEAR	-40 to 125	TL1704
TLV1704AIPWR.B	Active	Production	TSSOP (PW)   14	2000   LARGE T&R	Yes	NIPDAU	Level-2-260C-1 YEAR	-40 to 125	TL1704
TLV1704AIPWRG4	Active	Production	TSSOP (PW)   14	2000   LARGE T&R	Yes	NIPDAU	Level-2-260C-1 YEAR	-40 to 125	TL1704

Orderable part number	Status (1)	Material type (2)	Package   Pins	Package qty   Carrier	RoHS (3)	Lead finish/ Ball material (4)	MSL rating/ Peak reflow (5)	Op temp (°C)	Part marking (6)
TLV1704AIPWRG4.B	Active	Production	TSSOP (PW)   14	2000   LARGE T&R	Yes	NIPDAU	Level-2-260C-1 YEAR	-40 to 125	TL1704

(1) **Status:** For more details on status, see our [product life cycle](#).

(2) **Material type:** When designated, preproduction parts are prototypes/experimental devices, and are not yet approved or released for full production. Testing and final process, including without limitation quality assurance, reliability performance testing, and/or process qualification, may not yet be complete, and this item is subject to further changes or possible discontinuation. If available for ordering, purchases will be subject to an additional waiver at checkout, and are intended for early internal evaluation purposes only. These items are sold without warranties of any kind.

(3) **RoHS values:** Yes, No, RoHS Exempt. See the [TI RoHS Statement](#) for additional information and value definition.

(4) **Lead finish/Ball material:** Parts may have multiple material finish options. Finish options are separated by a vertical ruled line. Lead finish/Ball material values may wrap to two lines if the finish value exceeds the maximum column width.

(5) **MSL rating/Peak reflow:** The moisture sensitivity level ratings and peak solder (reflow) temperatures. In the event that a part has multiple moisture sensitivity ratings, only the lowest level per JEDEC standards is shown. Refer to the shipping label for the actual reflow temperature that will be used to mount the part to the printed circuit board.

(6) **Part marking:** There may be an additional marking, which relates to the logo, the lot trace code information, or the environmental category of the part.

Multiple part markings will be inside parentheses. Only one part marking contained in parentheses and separated by a "~" will appear on a part. If a line is indented then it is a continuation of the previous line and the two combined represent the entire part marking for that device.

**Important Information and Disclaimer:** The information provided on this page represents TI's knowledge and belief as of the date that it is provided. TI bases its knowledge and belief on information provided by third parties, and makes no representation or warranty as to the accuracy of such information. Efforts are underway to better integrate information from third parties. TI has taken and continues to take reasonable steps to provide representative and accurate information but may not have conducted destructive testing or chemical analysis on incoming materials and chemicals. TI and TI suppliers consider certain information to be proprietary, and thus CAS numbers and other limited information may not be available for release.

In no event shall TI's liability arising out of such information exceed the total purchase price of the TI part(s) at issue in this document sold by TI to Customer on an annual basis.

**OTHER QUALIFIED VERSIONS OF TLV1701, TLV1702, TLV1704 :**

- Automotive : [TLV1701-Q1](#), [TLV1702-Q1](#), [TLV1704-Q1](#)

NOTE: Qualified Version Definitions:

- Automotive - Q100 devices qualified for high-reliability automotive applications targeting zero defects

**TAPE AND REEL INFORMATION**

**QUADRANT ASSIGNMENTS FOR PIN 1 ORIENTATION IN TAPE**

\*All dimensions are nominal

Device	Package Type	Package Drawing	Pins	SPQ	Reel Diameter (mm)	Reel Width W1 (mm)	A0 (mm)	B0 (mm)	K0 (mm)	P1 (mm)	W (mm)	Pin1 Quadrant
TLV1701AIDBVR	SOT-23	DBV	5	3000	178.0	8.4	3.2	3.2	1.4	4.0	8.0	Q3
TLV1701AIDBVT	SOT-23	DBV	5	250	180.0	8.4	3.2	3.2	1.4	4.0	8.0	Q3
TLV1701AIDCKR	SC70	DCK	5	3000	178.0	8.4	2.25	2.45	1.2	4.0	8.0	Q3
TLV1701AIDCKR	SC70	DCK	5	3000	180.0	8.4	2.3	2.5	1.2	4.0	8.0	Q3
TLV1701AIDCKRG4	SC70	DCK	5	3000	178.0	9.0	2.4	2.5	1.2	4.0	8.0	Q3
TLV1701AIDCKT	SC70	DCK	5	250	180.0	8.4	2.3	2.5	1.2	4.0	8.0	Q3
TLV1701AIDRLR	SOT-5X3	DRL	5	4000	180.0	8.4	1.98	1.78	0.69	4.0	8.0	Q3
TLV1701AIDRLT	SOT-5X3	DRL	5	250	180.0	8.4	1.98	1.78	0.69	4.0	8.0	Q3
TLV1702AIDGKR	VSSOP	DGK	8	2500	330.0	12.4	5.3	3.4	1.4	8.0	12.0	Q1
TLV1702AIDGKRG4	VSSOP	DGK	8	2500	330.0	12.4	5.3	3.4	1.4	8.0	12.0	Q1
TLV1702AIRUGR	X2QFN	RUG	8	3000	180.0	8.4	1.6	1.6	0.66	4.0	8.0	Q2
TLV1704AIPWR	TSSOP	PW	14	2000	330.0	12.4	6.9	5.6	1.6	8.0	12.0	Q1
TLV1704AIPWRG4	TSSOP	PW	14	2000	330.0	12.4	6.9	5.6	1.6	8.0	12.0	Q1

**TAPE AND REEL BOX DIMENSIONS**

\*All dimensions are nominal

Device	Package Type	Package Drawing	Pins	SPQ	Length (mm)	Width (mm)	Height (mm)
TLV1701AIDBVR	SOT-23	DBV	5	3000	208.0	191.0	35.0
TLV1701AIDBVT	SOT-23	DBV	5	250	210.0	185.0	35.0
TLV1701AIDCKR	SC70	DCK	5	3000	208.0	191.0	35.0
TLV1701AIDCKR	SC70	DCK	5	3000	210.0	185.0	35.0
TLV1701AIDCKRG4	SC70	DCK	5	3000	190.0	190.0	30.0
TLV1701AIDCKT	SC70	DCK	5	250	210.0	185.0	35.0
TLV1701AIDRLR	SOT-5X3	DRL	5	4000	202.0	201.0	28.0
TLV1701AIDRLT	SOT-5X3	DRL	5	250	202.0	201.0	28.0
TLV1702AIDGKR	VSSOP	DGK	8	2500	353.0	353.0	32.0
TLV1702AIDGKRG4	VSSOP	DGK	8	2500	353.0	353.0	32.0
TLV1702AIRUGR	X2QFN	RUG	8	3000	202.0	201.0	28.0
TLV1704AIPWR	TSSOP	PW	14	2000	353.0	353.0	32.0
TLV1704AIPWRG4	TSSOP	PW	14	2000	353.0	353.0	32.0

**TUBE**

\*All dimensions are nominal

Device	Package Name	Package Type	Pins	SPQ	L (mm)	W (mm)	T (μm)	B (mm)
TLV1702AIDGK	DGK	VSSOP	8	80	330	6.55	500	2.88
TLV1702AIDGK.B	DGK	VSSOP	8	80	330	6.55	500	2.88
TLV1704AIPW	PW	TSSOP	14	90	530	10.2	3600	3.5
TLV1704AIPW.B	PW	TSSOP	14	90	530	10.2	3600	3.5

# DBV0005A



# PACKAGE OUTLINE

SOT-23 - 1.45 mm max height

SMALL OUTLINE TRANSISTOR

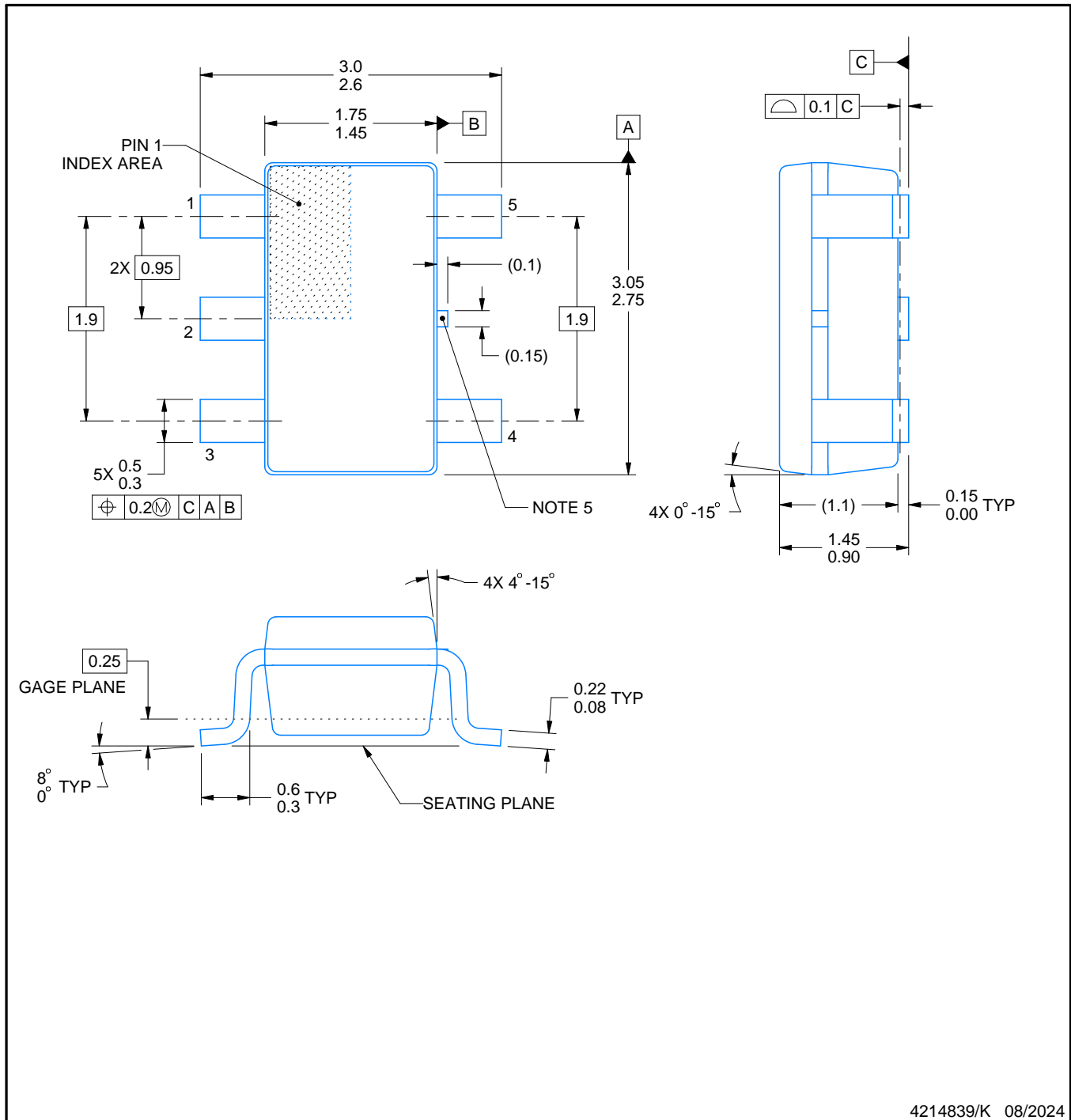

### NOTES:

1. All linear dimensions are in millimeters. Any dimensions in parenthesis are for reference only. Dimensioning and tolerancing per ASME Y14.5M.
2. This drawing is subject to change without notice.
3. Reference JEDEC MO-178.
4. Body dimensions do not include mold flash, protrusions, or gate burrs. Mold flash, protrusions, or gate burrs shall not exceed 0.25 mm per side.
5. Support pin may differ or may not be present.

# EXAMPLE BOARD LAYOUT

DBV0005A

SOT-23 - 1.45 mm max height

SMALL OUTLINE TRANSISTOR



LAND PATTERN EXAMPLE  
EXPOSED METAL SHOWN  
SCALE:15X

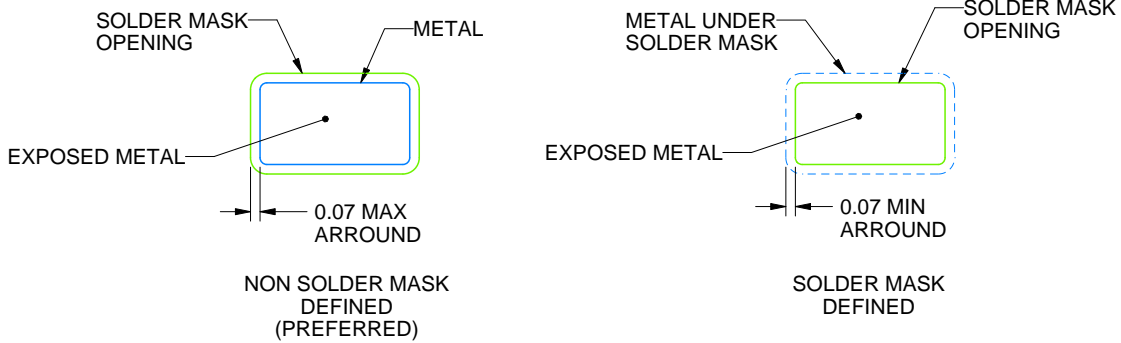

SOLDER MASK DETAILS

4214839/K 08/2024

NOTES: (continued)

- 6. Publication IPC-7351 may have alternate designs.
- 7. Solder mask tolerances between and around signal pads can vary based on board fabrication site.

# EXAMPLE STENCIL DESIGN

DBV0005A

SOT-23 - 1.45 mm max height

SMALL OUTLINE TRANSISTOR



SOLDER PASTE EXAMPLE  
BASED ON 0.125 mm THICK STENCIL  
SCALE:15X

4214839/K 08/2024

NOTES: (continued)

8. Laser cutting apertures with trapezoidal walls and rounded corners may offer better paste release. IPC-7525 may have alternate design recommendations.
9. Board assembly site may have different recommendations for stencil design.



# DGK0008A



# PACKAGE OUTLINE

VSSOP - 1.1 mm max height

SMALL OUTLINE PACKAGE



4214862/A 04/2023

**NOTES:**

PowerPAD is a trademark of Texas Instruments.

1. All linear dimensions are in millimeters. Any dimensions in parenthesis are for reference only. Dimensioning and tolerancing per ASME Y14.5M.
2. This drawing is subject to change without notice.
3. This dimension does not include mold flash, protrusions, or gate burrs. Mold flash, protrusions, or gate burrs shall not exceed 0.15 mm per side.
4. This dimension does not include interlead flash. Interlead flash shall not exceed 0.25 mm per side.
5. Reference JEDEC registration MO-187.

# EXAMPLE BOARD LAYOUT

DGK0008A

™ VSSOP - 1.1 mm max height

SMALL OUTLINE PACKAGE

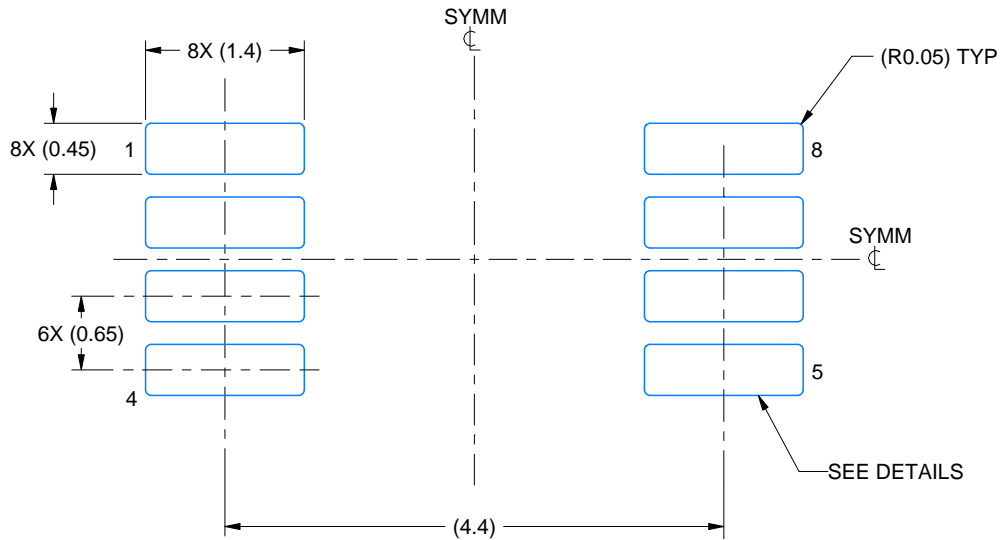

LAND PATTERN EXAMPLE  
EXPOSED METAL SHOWN  
SCALE: 15X

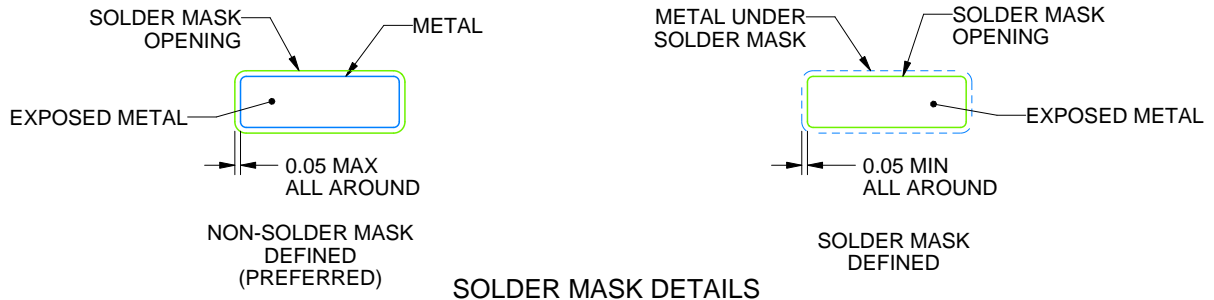

4214862/A 04/2023

NOTES: (continued)

6. Publication IPC-7351 may have alternate designs.
7. Solder mask tolerances between and around signal pads can vary based on board fabrication site.
8. Vias are optional depending on application, refer to device data sheet. If any vias are implemented, refer to their locations shown on this view. It is recommended that vias under paste be filled, plugged or tented.
9. Size of metal pad may vary due to creepage requirement.

# EXAMPLE STENCIL DESIGN

DGK0008A

™ VSSOP - 1.1 mm max height

SMALL OUTLINE PACKAGE



SOLDER PASTE EXAMPLE  
SCALE: 15X

4214862/A 04/2023

NOTES: (continued)

11. Laser cutting apertures with trapezoidal walls and rounded corners may offer better paste release. IPC-7525 may have alternate design recommendations.
12. Board assembly site may have different recommendations for stencil design.

# DRL0005A

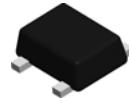

# PACKAGE OUTLINE

SOT - 0.6 mm max height

PLASTIC SMALL OUTLINE

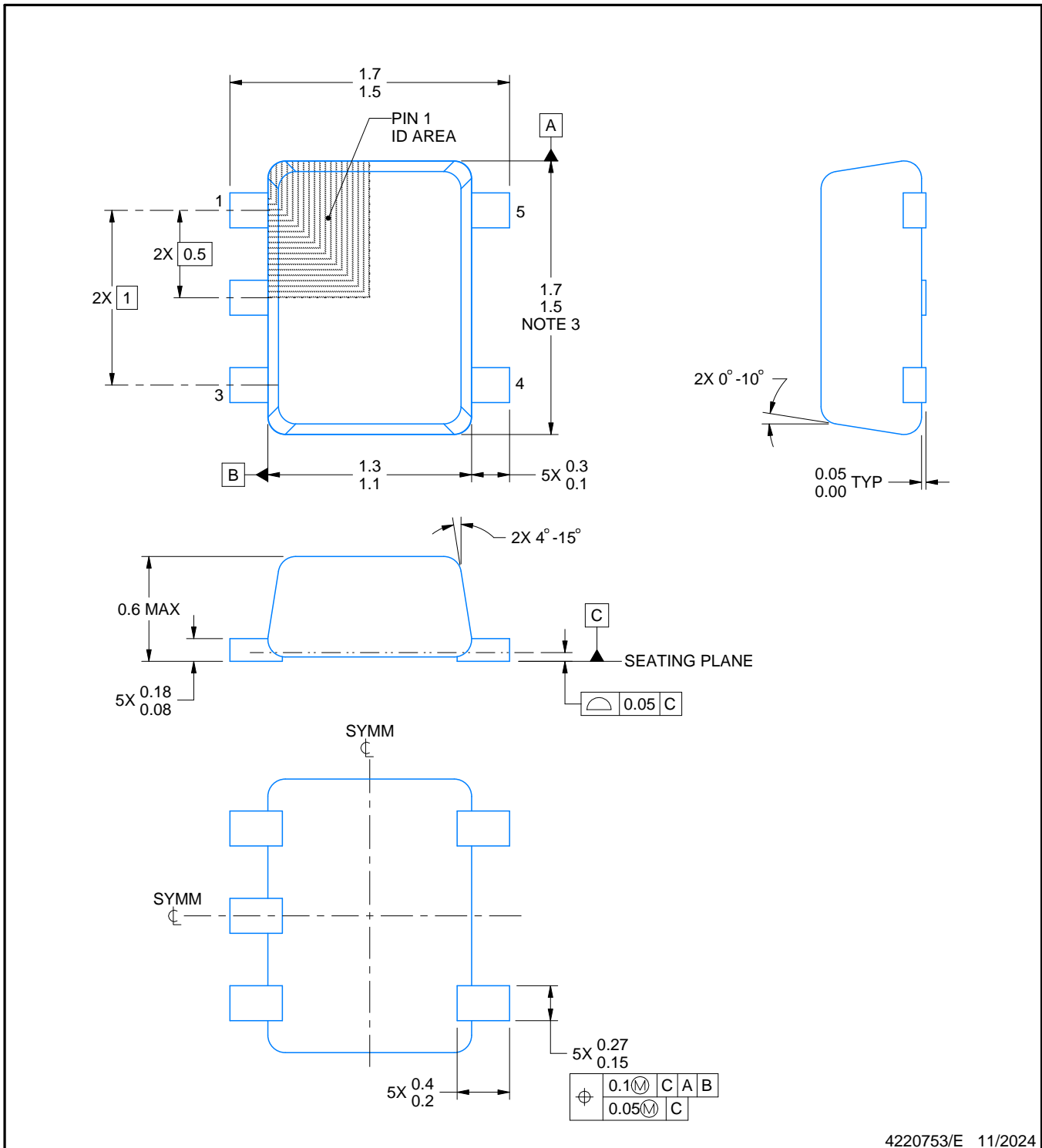

4220753/E 11/2024

**NOTES:**

1. All linear dimensions are in millimeters. Any dimensions in parenthesis are for reference only. Dimensioning and tolerancing per ASME Y14.5M.
2. This drawing is subject to change without notice.
3. This dimension does not include mold flash, protrusions, or gate burrs. Mold flash, protrusions, or gate burrs shall not exceed 0.15 mm per side.
4. Reference JEDEC registration MO-293 Variation UAAD-1

# EXAMPLE BOARD LAYOUT

DRL0005A

SOT - 0.6 mm max height

PLASTIC SMALL OUTLINE

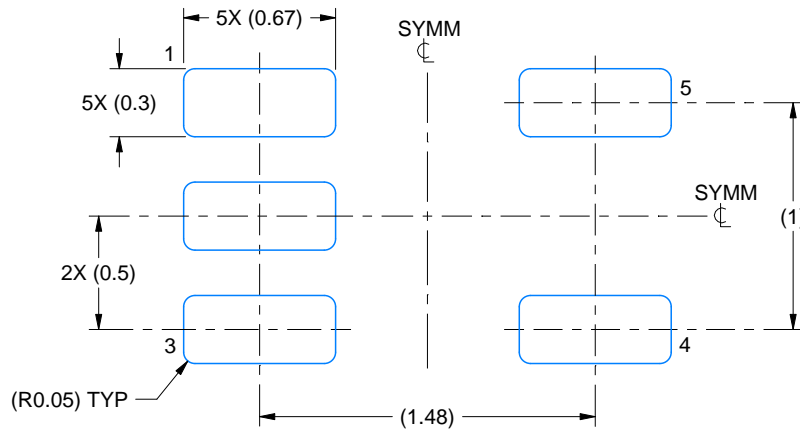

LAND PATTERN EXAMPLE  
SCALE:30X

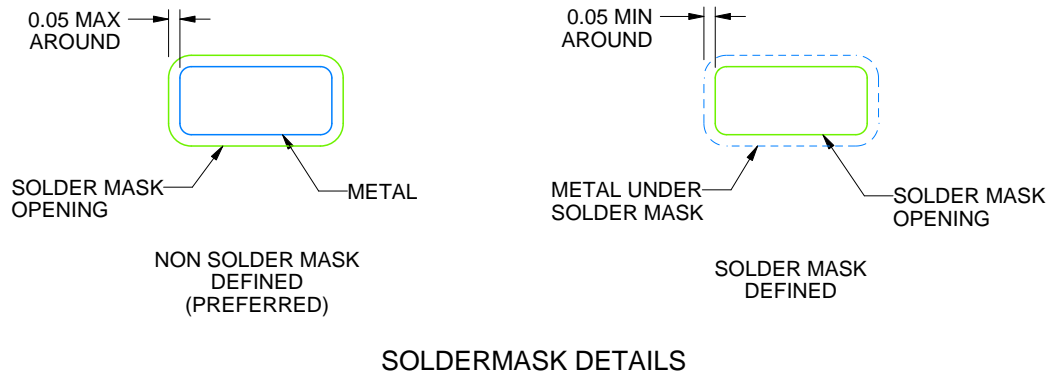

SOLDERMASK DETAILS

4220753/E 11/2024

NOTES: (continued)

- 5. Publication IPC-7351 may have alternate designs.
- 6. Solder mask tolerances between and around signal pads can vary based on board fabrication site.

# EXAMPLE STENCIL DESIGN

DRL0005A

SOT - 0.6 mm max height

PLASTIC SMALL OUTLINE

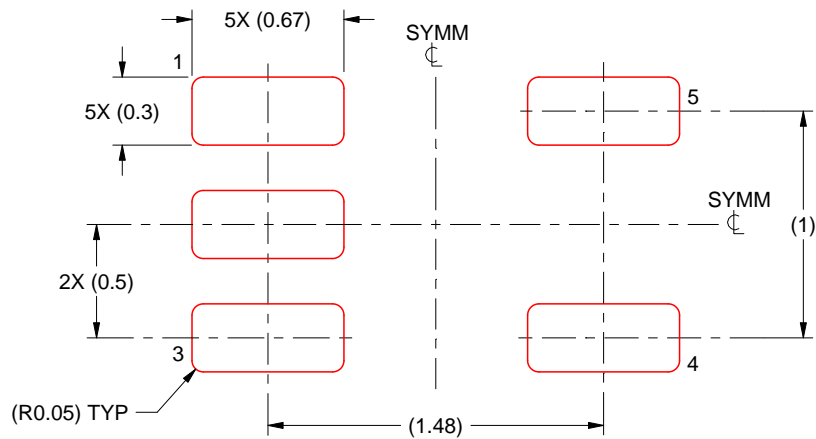

SOLDER PASTE EXAMPLE  
BASED ON 0.1 mm THICK STENCIL  
SCALE:30X

4220753/E 11/2024

NOTES: (continued)

7. Laser cutting apertures with trapezoidal walls and rounded corners may offer better paste release. IPC-7525 may have alternate design recommendations.
8. Board assembly site may have different recommendations for stencil design.

RUG (S-PQFP-N8)

PLASTIC QUAD FLATPACK

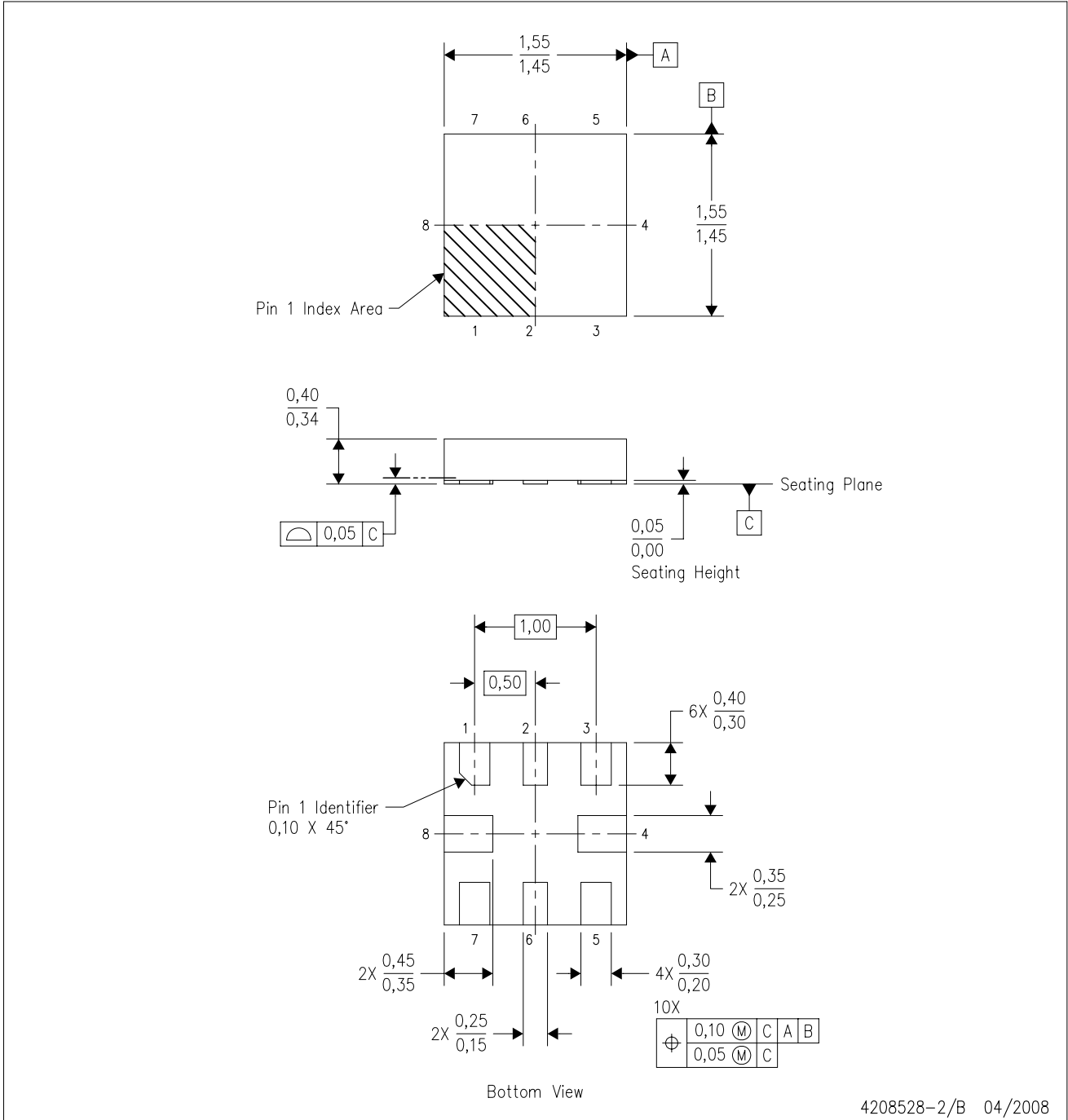

4208528-2/B 04/2008

- NOTES:
- A. All linear dimensions are in millimeters. Dimensioning and tolerancing per ASME Y14.5M-1994.
  - B. This drawing is subject to change without notice.
  - C. QFN (Quad Flatpack No-Lead) package configuration.
  - D. This package complies to JEDEC MO-288 variation X2ECD.

# DCK0005A



# PACKAGE OUTLINE

SOT - 1.1 max height

SMALL OUTLINE TRANSISTOR

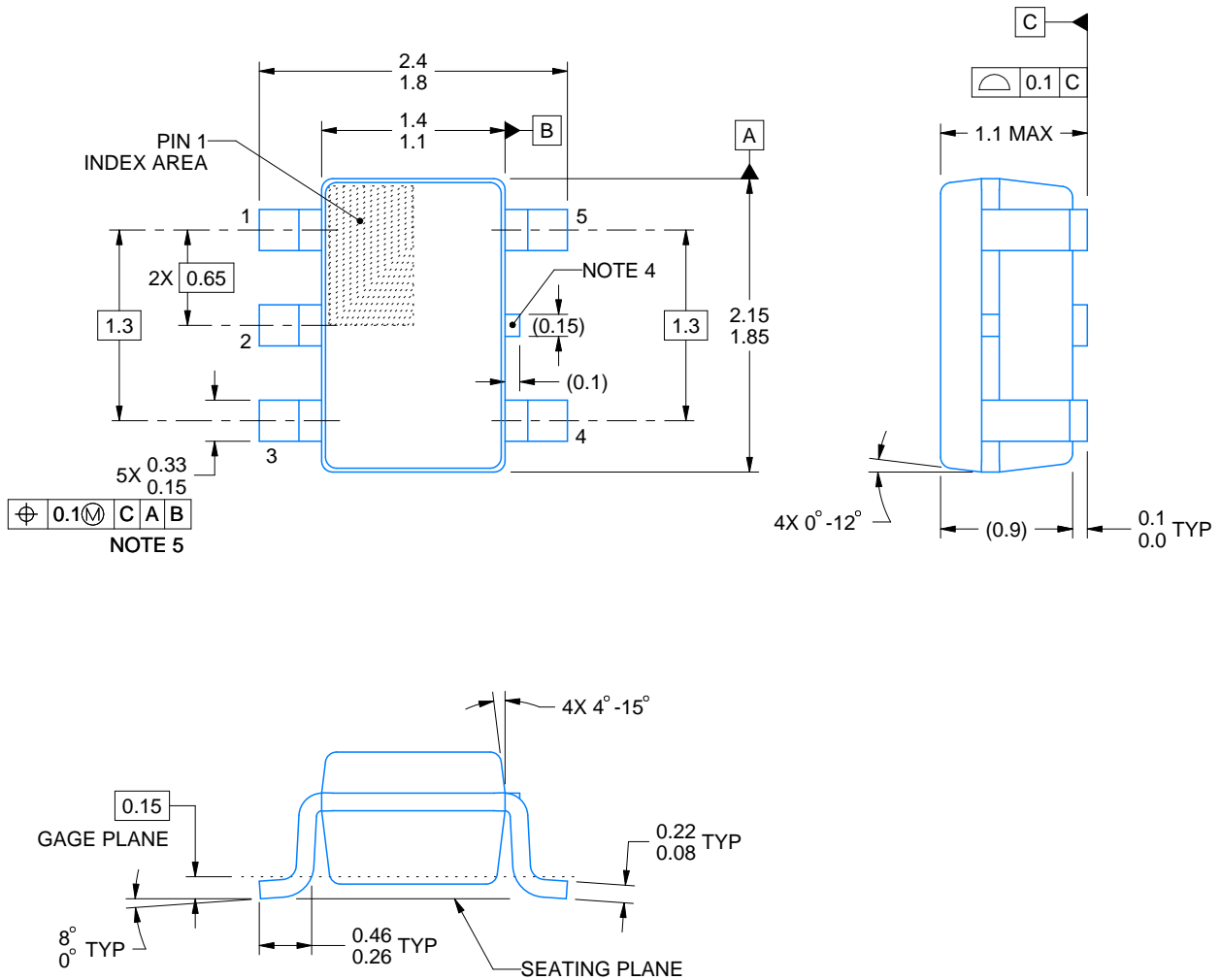

4214834/G 11/2024

## NOTES:

1. All linear dimensions are in millimeters. Any dimensions in parenthesis are for reference only. Dimensioning and tolerancing per ASME Y14.5M.
2. This drawing is subject to change without notice.
3. Reference JEDEC MO-203.
4. Support pin may differ or may not be present.
5. Lead width does not comply with JEDEC.
6. Body dimensions do not include mold flash, protrusions, or gate burrs. Mold flash, protrusions, or gate burrs shall not exceed 0.25mm per side



# EXAMPLE BOARD LAYOUT

DCK0005A

SOT - 1.1 max height

SMALL OUTLINE TRANSISTOR

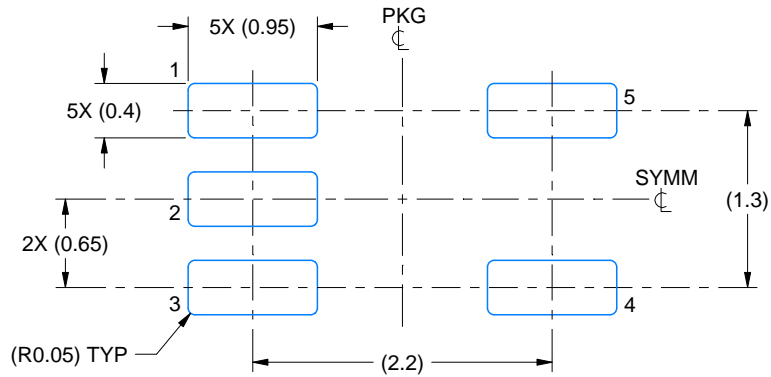

LAND PATTERN EXAMPLE  
EXPOSED METAL SHOWN  
SCALE:18X

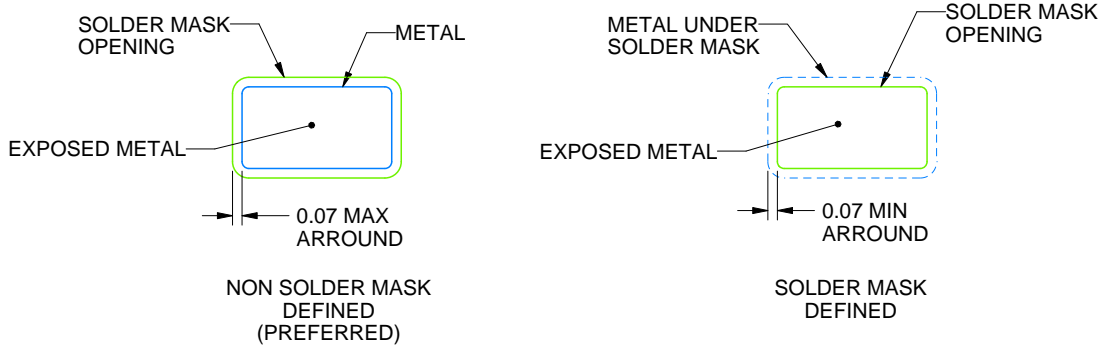

SOLDER MASK DETAILS

4214834/G 11/2024

NOTES: (continued)

- 7. Publication IPC-7351 may have alternate designs.
- 8. Solder mask tolerances between and around signal pads can vary based on board fabrication site.

# EXAMPLE STENCIL DESIGN

DCK0005A

SOT - 1.1 max height

SMALL OUTLINE TRANSISTOR

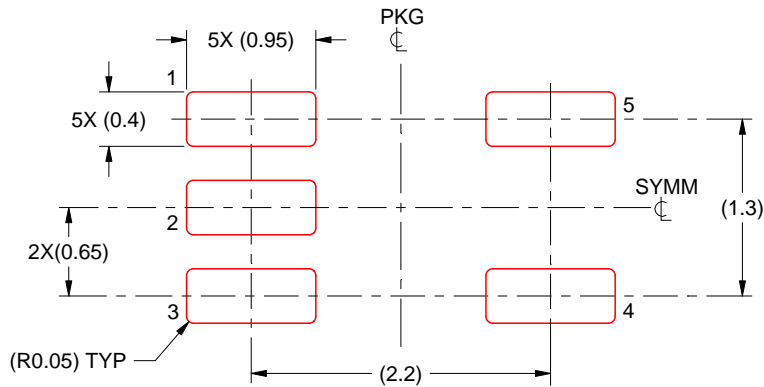

SOLDER PASTE EXAMPLE  
BASED ON 0.125 THICK STENCIL  
SCALE: 18X

4214834/G 11/2024

NOTES: (continued)

9. Laser cutting apertures with trapezoidal walls and rounded corners may offer better paste release. IPC-7525 may have alternate design recommendations.
10. Board assembly site may have different recommendations for stencil design.

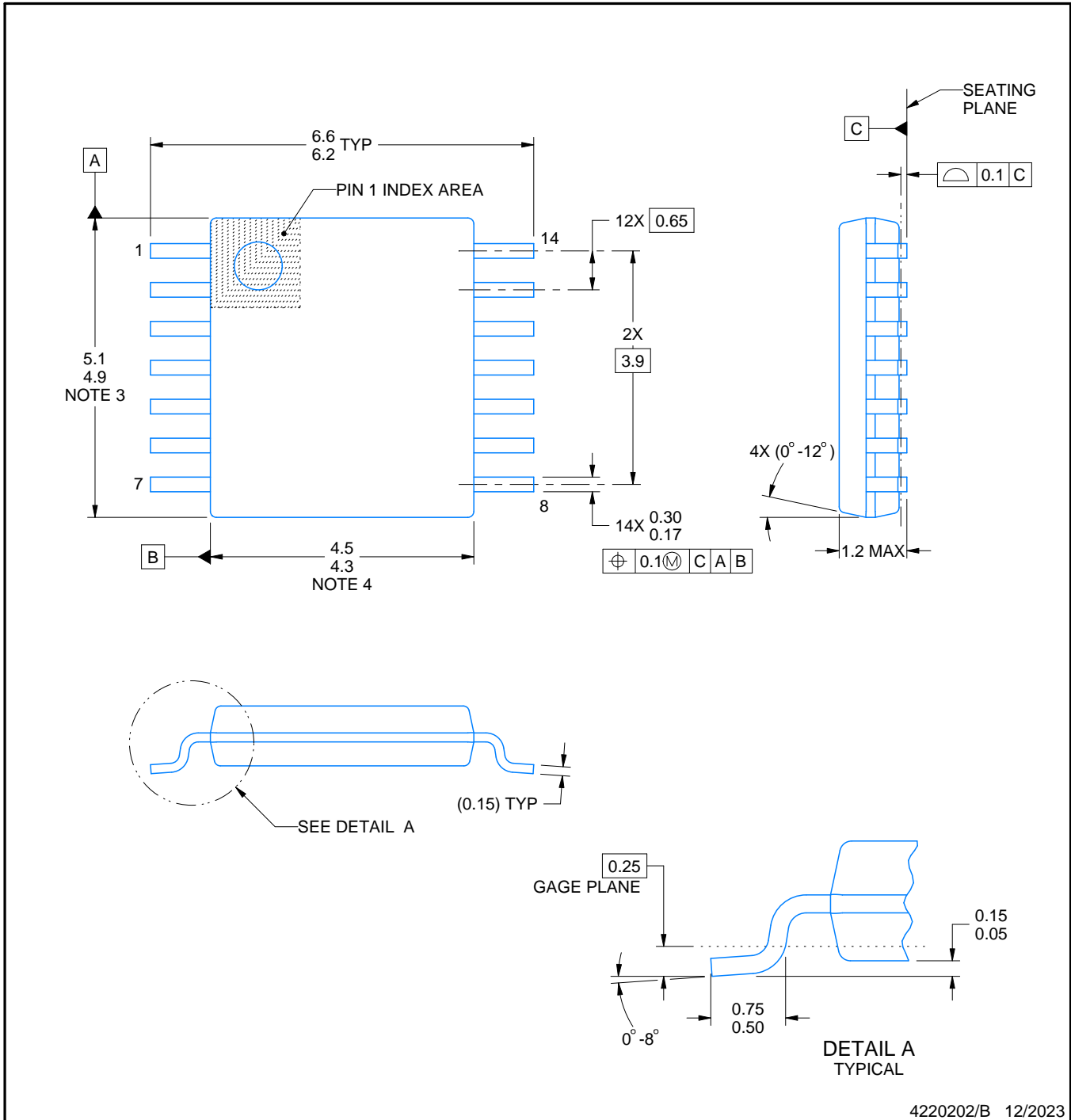

NOTES:

1. All linear dimensions are in millimeters. Any dimensions in parenthesis are for reference only. Dimensioning and tolerancing per ASME Y14.5M.
2. This drawing is subject to change without notice.
3. This dimension does not include mold flash, protrusions, or gate burrs. Mold flash, protrusions, or gate burrs shall not exceed 0.15 mm per side.
4. This dimension does not include interlead flash. Interlead flash shall not exceed 0.25 mm per side.
5. Reference JEDEC registration MO-153.

# EXAMPLE BOARD LAYOUT

PW0014A

TSSOP - 1.2 mm max height

SMALL OUTLINE PACKAGE

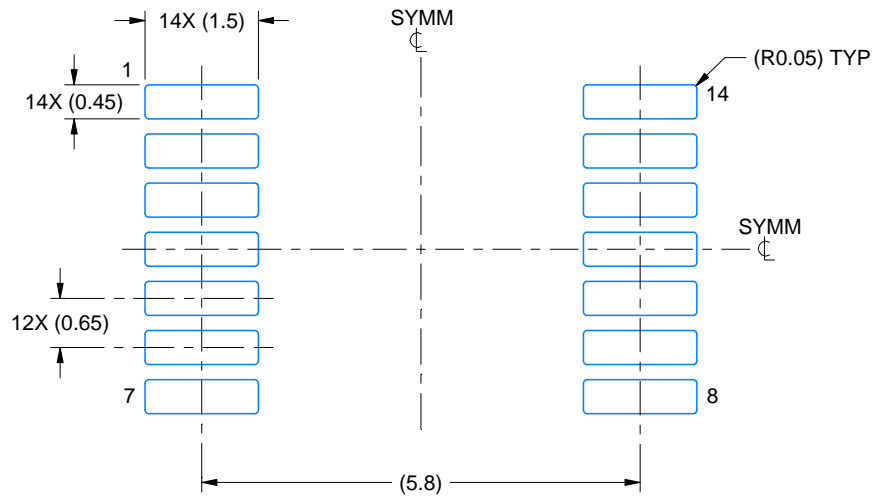

LAND PATTERN EXAMPLE  
EXPOSED METAL SHOWN  
SCALE: 10X

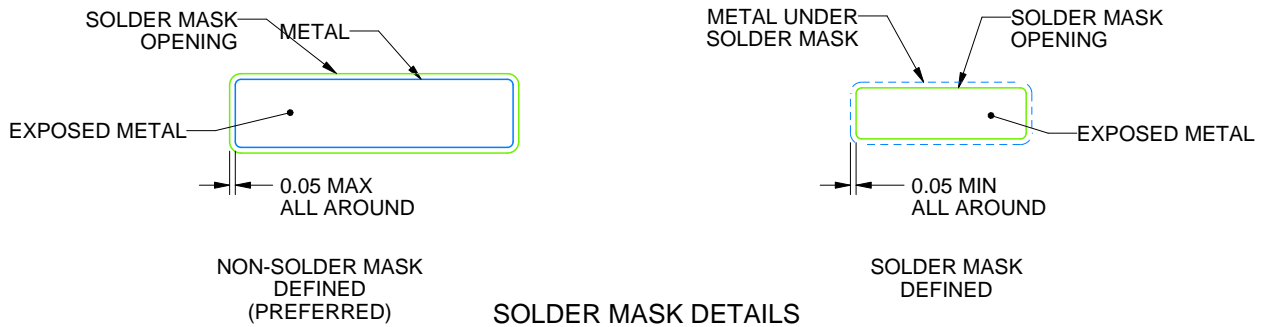

4220202/B 12/2023

NOTES: (continued)

- 6. Publication IPC-7351 may have alternate designs.
- 7. Solder mask tolerances between and around signal pads can vary based on board fabrication site.

# EXAMPLE STENCIL DESIGN

PW0014A

TSSOP - 1.2 mm max height

SMALL OUTLINE PACKAGE

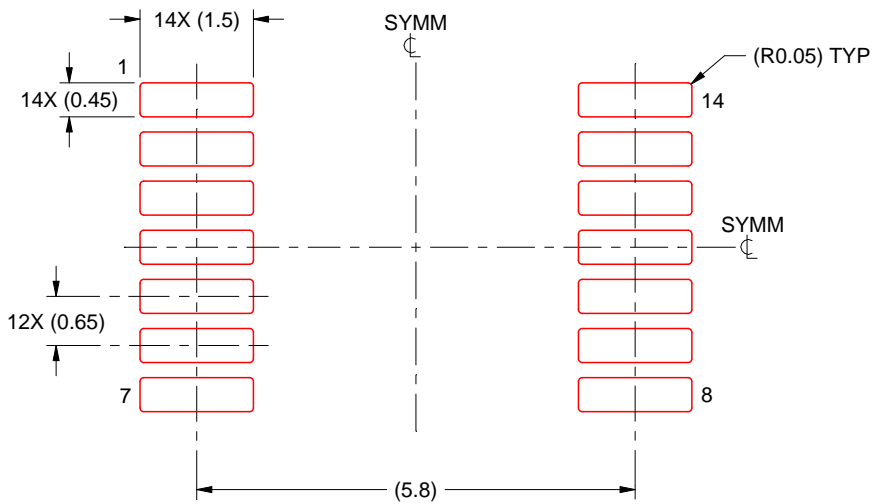

SOLDER PASTE EXAMPLE  
BASED ON 0.125 mm THICK STENCIL  
SCALE: 10X

4220202/B 12/2023

NOTES: (continued)

8. Laser cutting apertures with trapezoidal walls and rounded corners may offer better paste release. IPC-7525 may have alternate design recommendations.
9. Board assembly site may have different recommendations for stencil design.

## IMPORTANT NOTICE AND DISCLAIMER

TI PROVIDES TECHNICAL AND RELIABILITY DATA (INCLUDING DATASHEETS), DESIGN RESOURCES (INCLUDING REFERENCE DESIGNS), APPLICATION OR OTHER DESIGN ADVICE, WEB TOOLS, SAFETY INFORMATION, AND OTHER RESOURCES "AS IS" AND WITH ALL FAULTS, AND DISCLAIMS ALL WARRANTIES, EXPRESS AND IMPLIED, INCLUDING WITHOUT LIMITATION ANY IMPLIED WARRANTIES OF MERCHANTABILITY, FITNESS FOR A PARTICULAR PURPOSE OR NON-INFRINGEMENT OF THIRD PARTY INTELLECTUAL PROPERTY RIGHTS.

These resources are intended for skilled developers designing with TI products. You are solely responsible for (1) selecting the appropriate TI products for your application, (2) designing, validating and testing your application, and (3) ensuring your application meets applicable standards, and any other safety, security, regulatory or other requirements.

These resources are subject to change without notice. TI grants you permission to use these resources only for development of an application that uses the TI products described in the resource. Other reproduction and display of these resources is prohibited. No license is granted to any other TI intellectual property right or to any third party intellectual property right. TI disclaims responsibility for, and you fully indemnify TI and its representatives against any claims, damages, costs, losses, and liabilities arising out of your use of these resources.

TI's products are provided subject to [TI's Terms of Sale](#), [TI's General Quality Guidelines](#), or other applicable terms available either on [ti.com](http://ti.com) or provided in conjunction with such TI products. TI's provision of these resources does not expand or otherwise alter TI's applicable warranties or warranty disclaimers for TI products. Unless TI explicitly designates a product as custom or customer-specified, TI products are standard, catalog, general purpose devices.

TI objects to and rejects any additional or different terms you may propose.

Copyright © 2025, Texas Instruments Incorporated

Last updated 10/2025