

# THS1206-EP

## 12-BIT 6 MSPS, SIMULTANEOUS SAMPLING ANALOG-TO-DIGITAL CONVERTERS

SGLS126A – JULY 2002 – REVISED FEBRUARY 2003

### features

- **Controlled Baseline**
  - One Assembly/Test Site, One Fabrication Site
- **Extended Temperature Performance of –55°C to 125°C**
- **Enhanced Diminishing Manufacturing Sources (DMS) Support**
- **Enhanced Product Change Notification**
- **Qualification Pedigree†**
- **High-Speed 6 MSPS ADC**
- **4 Single-Ended or 2 Differential Inputs**
- **Simultaneous Sampling of 4 Single-Ended Signals or 2 Differential Signals or Combination of Both**
- **Differential Nonlinearity Error: ±1 LSB**
- **Integral Nonlinearity Error: ±1.8 LSB**
- **Signal-to-Noise and Distortion Ratio: 68 dB at  $f_1 = 2$  MHz**
- **Auto-Scan Mode for 2, 3, or 4 Inputs**
- **3-V or 5-V Digital Interface Compatible**
- **Low Power: 216 mW Max**
- **5-V Analog Single Supply Operation**

† Component qualification in accordance with JEDEC and industry standards to ensure reliable operation over an extended temperature range. This includes, but is not limited to, Highly Accelerated Stress Test (HAST) or biased 85/85, temperature cycle, autoclave or unbiased HAST, electromigration, bond intermetallic life, and mold compound life. Such qualification testing should not be viewed as justifying use of this component beyond specified performance and environmental limits.

### description

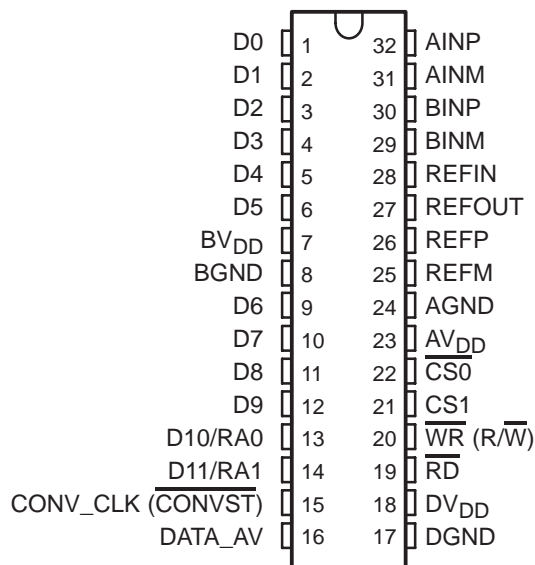
The THS1206 is a CMOS, low-power, 12-bit, 6 MSPS analog-to-digital converter (ADC). The speed, resolution, bandwidth, and single-supply operation are suited for applications in radar, imaging, high-speed acquisition, and communications. A multistage pipelined architecture with output error correction logic provides for no missing codes over the full operating temperature range. Internal control registers are used to program the ADC into the desired mode. The THS1206 consists of four analog inputs, which are sampled simultaneously. These inputs can be selected individually and configured to single-ended or differential inputs. An integrated 16 word deep FIFO allows the storage of data in order to take the load off of the processor connected to the ADC. Internal reference voltages for the ADC (1.5 V and 3.5 V) are provided.

- **Internal Voltage References . . . 50 PPM/°C and ±5% Accuracy**
- **Glueless DSP Interface**
- **Parallel  $\mu$ C/DSP Interface**
- **Integrated FIFO**
- **Available in TSSOP Package**

### applications

- **Radar Applications**
- **Communications**
- **Control Applications**
- **High-Speed DSP Front-End**
- **Selected Military Applications**

DA PACKAGE  
(TOP VIEW)



Please be aware that an important notice concerning availability, standard warranty, and use in critical applications of Texas Instruments semiconductor products and disclaimers thereto appears at the end of this data sheet.

PRODUCTION DATA information is current as of publication date. Products conform to specifications per the terms of Texas Instruments standard warranty. Production processing does not necessarily include testing of all parameters.



POST OFFICE BOX 655303 • DALLAS, TEXAS 75265

Copyright © 2002 – 2003, Texas Instruments Incorporated

# THS1206-EP 12-BIT 6 MSPS, SIMULTANEOUS SAMPLING ANALOG-TO-DIGITAL CONVERTERS

SGLS126A – JULY 2002 – REVISED FEBRUARY 2003

## description (continued)

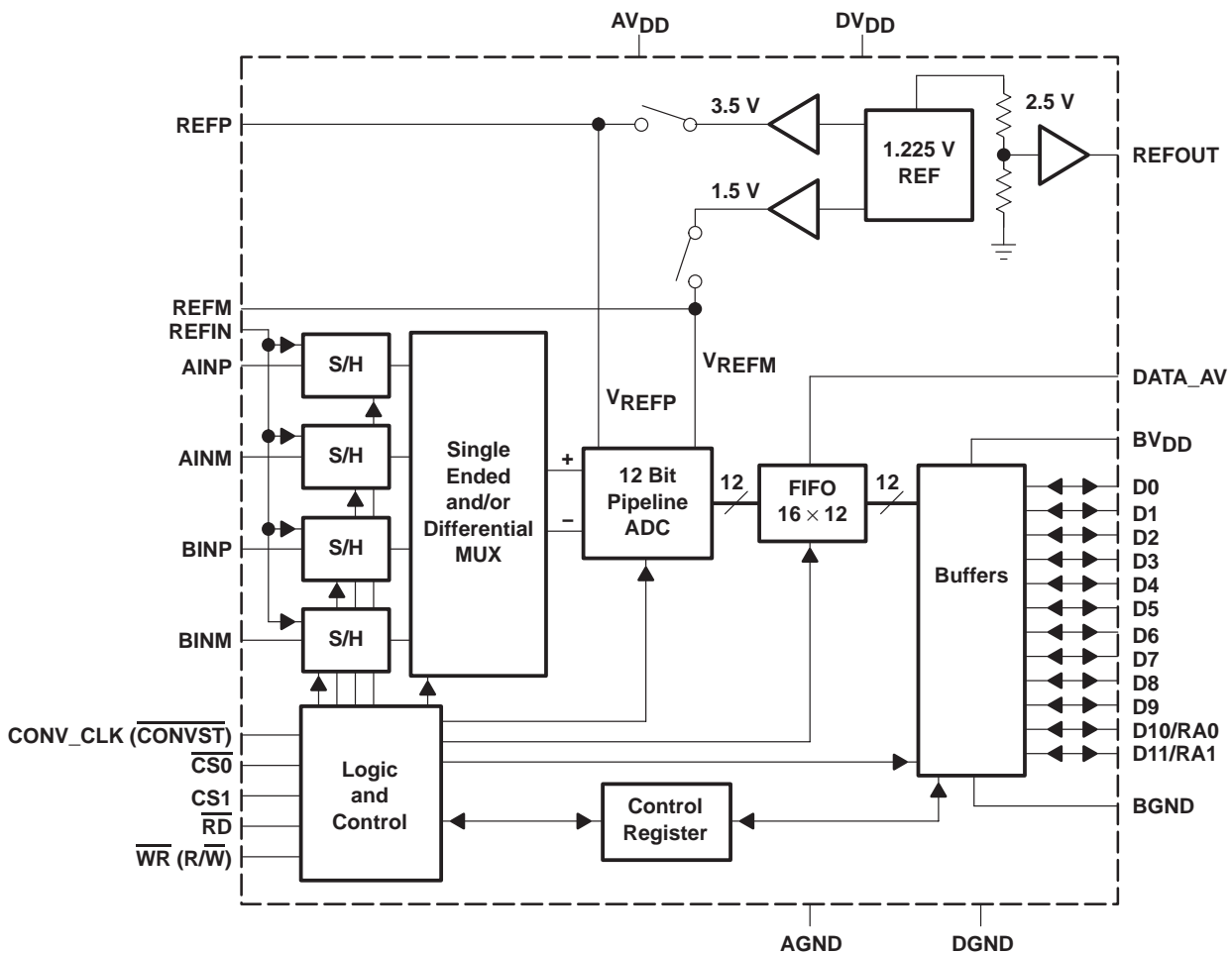
An external reference can also be chosen to suit the dc accuracy and temperature drift requirements of the application. Two different conversion modes can be selected. In single conversion mode, a single and simultaneous conversion of up to four inputs can be initiated by using the single conversion start signal ( $\overline{\text{CONVST}}$ ). The conversion clock in single conversion mode is generated internally using a clock oscillator circuit. In continuous conversion mode, an external clock signal is applied to the CONV\_CLK input of the THS1206. The internal clock oscillator is switched off in continuous conversion mode.

## ORDERING INFORMATION

| T <sub>A</sub> | PACKAGE†                    | ORDERABLE PART NUMBER | TOP-SIDE MARKING |
|----------------|-----------------------------|-----------------------|------------------|
| -55°C to 125°C | TSSOP – DA    Tape and reel | THS1206MDAREP         | THS1206MEP       |

† Package drawings, standard packing quantities, thermal data, symbolization, and PCB design guidelines are available at [www.ti.com/sc/package](http://www.ti.com/sc/package).

## functional block diagram



### Terminal Functions

| TERMINAL<br>NAME  | NO.       | I/O   | DESCRIPTION  |
|---|-----------|-------|--|
| AINP  | 32        | I     | Analog input, single-ended or positive input of differential channel A   |
| AINM  | 31        | I     | Analog input, single-ended or negative input of differential channel A   |
| BINP  | 30        | I     | Analog input, single-ended or positive input of differential channel B   |
| BINM  | 29        | I     | Analog input, single-ended or negative input of differential channel B   |
| AV <sub>DD</sub>  | 23        | I     | Analog supply voltage  |
| AGND  | 24        | I     | Analog ground  |
| BV <sub>DD</sub>  | 7         | I     | Digital supply voltage for buffer  |
| BGND  | 8         | I     | Digital ground for buffer  |
| CONV_CLK ( $\overline{\text{CONVST}}$ )                       | 15        | I     | Digital input. This input is used to apply an external conversion clock in continuous conversion mode. In single conversion mode, this input functions as the conversion start ( $\overline{\text{CONVST}}$ ) input. A high to low transition on this input holds simultaneously the selected analog input channels and initiates a single conversion of all selected analog inputs. |
| $\overline{\text{CS0}}$                                       | 22        | I     | Chip select input (active low)   |
| CS1   | 21        | I     | Chip select input (active high)  |
| DATA_AV   | 16        | O     | Data available signal, which can be used to generate an interrupt for processors and as a level information of the internal FIFO. This signal can be configured to be active low or high and can be configured as a static level or pulse output. See Table 14.  |
| DGND  | 17        | I     | Digital ground. Ground reference for digital circuitry.  |
| DV <sub>DD</sub>  | 18        | I     | Digital supply voltage   |
| D0 – D9   | 1–6, 9–12 | I/O/Z | Digital input, output; D0 = LSB  |
| D10/RA0   | 13        | I/O/Z | Digital input, output. The data line D10 is also used as an address line (RA0) for the control register. This is required for writing to the control register 0 and control register 1. See Table 8.   |
| D11/RA1   | 14        | I/O/Z | Digital input, output (D11 = MSB). The data line D11 is also used as an address line (RA1) for the control register. This is required for writing to control register 0 and control register 1. See Table 8.   |
| REFIN   | 28        | I     | Common-mode reference input for the analog input channels. It is recommended that this pin be connected to the reference output REFOUT.  |
| REFP  | 26        | I     | Reference input, requires a bypass capacitor of 10 $\mu\text{F}$ to AGND in order to bypass the internal reference voltage. An external reference voltage at this input can be applied. This option can be programmed through control register 0. See Table 9.   |
| REFM  | 25        | I     | Reference input, requires a bypass capacitor of 10 $\mu\text{F}$ to AGND in order to bypass the internal reference voltage. An external reference voltage at this input can be applied. This option can be programmed through control register 0. See Table 9.   |
| REFOUT  | 27        | O     | Analog fixed reference output voltage of 2.5 V. Sink and source capability of 250 $\mu\text{A}$ . The reference output requires a capacitor of 10 $\mu\text{F}$ to AGND for filtering and stability.   |
| $\overline{\text{RD}}^\dagger$                                | 19        | I     | The $\overline{\text{RD}}$ input is used only if the $\overline{\text{WR}}$ input is configured as a write only input. In this case, it is a digital input, active low as a data read select from the processor. See timing section.   |
| $\overline{\text{WR}}$ (R/ $\overline{\text{W}}$ ) $^\dagger$ | 20        | I     | This input is programmable. It functions as a read-write input R/W and can also be configured as a write-only input $\overline{\text{WR}}$ , which is active low and used as data write select from the processor. In this case, the $\overline{\text{RD}}$ input is used as a read input from the processor. See timing section.  |

$^\dagger$  The start-conditions of  $\overline{\text{RD}}$  and  $\overline{\text{WR}}$  (R/W) are unknown. The first access to the ADC has to be a write access to initialize the ADC.

# THS1206-EP

## 12-BIT 6 MSPS, SIMULTANEOUS SAMPLING

### ANALOG-TO-DIGITAL CONVERTERS

SGLS126A – JULY 2002 – REVISED FEBRUARY 2003

#### absolute maximum ratings over operating free-air temperature (unless otherwise noted)†

|  |  |
|--|--|
| Supply voltage range, DGND to DV <sub>DD</sub>               | –0.3 V to 6.5 V                                      |
| BGND to BV <sub>DD</sub>                                     | –0.3 V to 6.5 V                                      |
| AGND to AV <sub>DD</sub>                                     | –0.3 V to 6.5 V                                      |
| Analog input voltage range                                   | AGND – 0.3 V to AV <sub>DD</sub> + 1.5 V             |
| Reference input voltage                                      | –0.3 + AGND to AV <sub>DD</sub> + 0.3 V              |
| Digital input voltage range                                  | –0.3 V to BV <sub>DD</sub> /DV <sub>DD</sub> + 0.3 V |
| Operating virtual junction temperature range, T <sub>J</sub> | –55°C to 150°C                                       |
| Operating free-air temperature range, T <sub>A</sub>         | –55°C to 125°C                                       |
| Storage temperature range, T <sub>stg</sub>                  | –65°C to 150°C                                       |
| Lead temperature 1,6 mm (1/16 inch) from case for 10 seconds | 260°C  |

† Stresses beyond those listed under “absolute maximum ratings” may cause permanent damage to the device. These are stress ratings only, and functional operation of the device at these or any other conditions beyond those indicated under “recommended operating conditions” is not implied. Exposure to absolute-maximum-rated conditions for extended periods may affect device reliability.

DISSIPATION RATING TABLE

| PACKAGE | T <sub>A</sub> ≤ 25°C<br>POWER RATING | DERATING FACTOR<br>ABOVE T <sub>A</sub> = 25°C‡ | T <sub>A</sub> = 70°C<br>POWER RATING | T <sub>A</sub> = 85°C<br>POWER RATING | T <sub>A</sub> = 125°C<br>POWER RATING |
|---------|---------------------------------------|---|---------------------------------------|---------------------------------------|--|
| DA      | 1453 mW                               | 11.62 mW/°C                                     | 930 mW                                | 756 mW                                | 291 mW                                 |

‡ This is the inverse of the traditional junction-to-ambient thermal resistance (R<sub>θJA</sub>). Thermal resistances are not production tested and are for informational purposes only.

#### recommended operating conditions

##### power supply

|                |                  | MIN  | NOM | MAX  | UNIT |
|----------------|------------------|------|-----|------|------|
| Supply voltage | AV <sub>DD</sub> | 4.75 | 5   | 5.25 | V    |
|                | DV <sub>DD</sub> | 3    | 3.3 | 5.25 |      |
|                | BV <sub>DD</sub> | 3    | 3.3 | 5.25 |      |

##### analog and reference inputs

|   | MIN               | NOM | MAX                   | UNIT |
|---|-------------------|-----|-----------------------|------|
| Analog input voltage in single-ended configuration                      | V <sub>REFM</sub> |     | V <sub>REFP</sub>     | V    |
| Common-mode input voltage V <sub>CM</sub> in differential configuration | 1                 | 2.5 | 4                     | V    |
| External reference voltage, V <sub>REFP</sub> (optional)                |                   | 3.5 | AV <sub>DD</sub> –1.2 | V    |
| External reference voltage, V <sub>REFM</sub> (optional)                | 1.4               | 1.5 |                       | V    |
| Input voltage difference, REFP – REFM                                   |                   | 2   |                       | V    |

##### digital inputs

|   |                                  | MIN | NOM | MAX  | UNIT |
|---|----------------------------------|-----|-----|------|------|
| High-level input voltage, V <sub>IH</sub>                       | BV <sub>DD</sub> = 3.3 V         | 2   |     |      | V    |
|   | BV <sub>DD</sub> = 5.25 V        | 2.6 |     |      | V    |
| Low-level input voltage, V <sub>IL</sub>                        | BV <sub>DD</sub> = 3.3 V         |     |     | 0.6  | V    |
|   | BV <sub>DD</sub> = 5.25 V        |     |     | 0.6  | V    |
| Input CONV_CLK frequency  | DV <sub>DD</sub> = 3 V to 5.25 V | 0.1 |     | 6    | MHz  |
| CONV_CLK pulse duration, clock high, t <sub>w</sub> (CONV_CLKH) | DV <sub>DD</sub> = 3 V to 5.25 V | 80  | 83  | 5000 | ns   |
| CONV_CLK pulse duration, clock low, t <sub>w</sub> (CONV_CLKL)  | DV <sub>DD</sub> = 3 V to 5.25 V | 80  | 83  | 5000 | ns   |
| Operating free-air temperature, T <sub>A</sub>                  |                                  | –55 |     | 125  | °C   |



**THS1206-EP**  
**12-BIT 6 MSPS, SIMULTANEOUS SAMPLING**  
**ANALOG-TO-DIGITAL CONVERTERS**

SGLS126A – JULY 2002 – REVISED FEBRUARY 2003

electrical characteristics over recommended operating conditions,  $V_{REF}$  = internal (unless otherwise noted)

**digital specifications**

| PARAMETER              |                                      | TEST CONDITIONS   | MIN           | TYP | MAX | UNIT    |
|------------------------|--------------------------------------|---|---------------|-----|-----|---------|
| <b>Digital inputs</b>  |                                      |   |               |     |     |         |
| $I_{IH}$               | High-level input current             | $DV_{DD}$ = digital inputs                                    | -50           |     | 50  | $\mu A$ |
| $I_{IL}$               | Low-level input current              | Digital input = 0 V   | -50           |     | 50  | $\mu A$ |
| $C_i$                  | Input capacitance                    |   |               | 5   |     | pF      |
| <b>Digital outputs</b> |                                      |   |               |     |     |         |
| $V_{OH}$               | High-level output voltage            | $I_{OH} = -50 \mu A$<br>$BV_{DD} = 3.3 V,$<br>$BV_{DD} = 5 V$ | $BV_{DD}-0.5$ |     |     | V       |
| $V_{OL}$               | Low-level output voltage             |   | $BV_{DD}-0.5$ |     | 0.4 | V       |
|                        |                                      |   |               | 0.4 |     |         |
| $I_{OZ}$               | High-impedance-state output current  | $CS1 = DGND,$ $CS0 = DV_{DD}$                                 | -10           |     | 10  | $\mu A$ |
| $C_O$                  | Output capacitance                   |   |               | 5   |     | pF      |
| $C_L$                  | Load capacitance at databus D0 – D11 |   |               |     | 30  | pF      |

**dc specifications**

| PARAMETER                         |  | TEST CONDITIONS                              | MIN | TYP | MAX       | UNIT             |
|-----------------------------------|--|--|-----|-----|-----------|------------------|
| Resolution                        |  |  | 12  |     |           | Bits             |
| <b>Accuracy</b>                   |  |  |     |     |           |                  |
| Integral nonlinearity, INL        |  |  |     |     | $\pm 1.8$ | LSB              |
| Differential nonlinearity, DNL    |  |  |     |     | $\pm 1$   | LSB              |
| Offset error                      | After calibration in single-ended mode |  |     | 20  |           | LSB              |
|                                   | After calibration in differential mode |  | -20 |     | 20        | LSB              |
| Gain error                        |  |  | -20 |     | 20        | LSB              |
| <b>Analog input</b>               |  |  |     |     |           |                  |
| Input capacitance                 |  |  |     | 15  |           | pF               |
| Input leakage current             |  | $V_{AIN} = V_{REFM}$ to $V_{REFP}$           |     |     | $\pm 10$  | $\mu A$          |
| <b>Internal voltage reference</b> |  |  |     |     |           |                  |
| Accuracy, $V_{REFP}$              |  |  | 3.3 | 3.5 | 3.7       | V                |
| Accuracy, $V_{REFM}$              |  |  | 1.3 | 1.5 | 1.7       | V                |
| Temperature coefficient           |  |  |     | 50  |           | PPM/ $^{\circ}C$ |
| Reference noise                   |  |  |     | 100 |           | $\mu V$          |
| Accuracy, $REF_{OUT}$             |  |  | 2.3 | 2.5 | 2.7       | V                |
| <b>Power supply</b>               |  |  |     |     |           |                  |
| $I_{DDA}$                         | Analog supply current                  | $AV_{DD} = 5 V,$ $BV_{DD} = DV_{DD} = 3.3 V$ |     | 36  | 40        | mA               |
| $I_{DDD}$                         | Digital supply voltage                 | $AV_{DD} = 5 V,$ $BV_{DD} = DV_{DD} = 3.3 V$ |     | 0.5 | 1         | mA               |
| $I_{DDB}$                         | Buffer supply voltage                  | $AV_{DD} = 5 V,$ $BV_{DD} = DV_{DD} = 3.3 V$ |     | 1.5 | 4         | mA               |
| $I_{DD\_P}$                       | Supply current in power-down mode      | $AV_{DD} = 5 V,$ $BV_{DD} = DV_{DD} = 3.3 V$ |     |     | 10        | mA               |
| Power dissipation                 |  | $AV_{DD} = 5 V,$ $DV_{DD} = BV_{DD} = 3.3 V$ |     | 186 | 216       | mW               |
| Power dissipation in power down   |  | $AV_{DD} = 5 V,$ $DV_{DD} = BV_{DD} = 3.3 V$ |     | 30  |           | mW               |

† Not production tested.



**THS1206-EP**  
**12-BIT 6 MSPS, SIMULTANEOUS SAMPLING**  
**ANALOG-TO-DIGITAL CONVERTERS**

SGLS126A – JULY 2002 – REVISED FEBRUARY 2003

electrical characteristics over recommended operating conditions,  $V_{REF}$  = internal,  $f_s$  = 6 MHz,  $f_I$  = 2 MHz at -1dBFS (unless otherwise noted)

ac specifications,  $AV_{DD}$  = 5 V,  $BV_{DD}$  =  $DV_{DD}$  = 3.3 V,  $C_L$  < 30 pF

| PARAMETER     |                                    | TEST CONDITIONS                | MIN   | TYP  | MAX | UNIT |
|---------------|------------------------------------|--------------------------------|-------|------|-----|------|
| SINAD         | Signal-to-noise ratio + distortion | Differential mode              | 63    | 65   |     | dB   |
|               |                                    | Single-ended mode (see Note 1) |       | 64   |     | dB   |
| SNR           | Signal-to-noise ratio              | Differential mode              | 64    | 69   |     | dB   |
|               |                                    | Single-ended mode (see Note 1) |       | 68   |     | dB   |
| THD           | Total harmonic distortion          | Differential mode              |       | -70  | -67 | dB   |
|               |                                    | Single-ended mode              |       | -68  |     |      |
| ENOB<br>(SNR) | Effective number of bits           | Differential mode              | 10.17 | 11   |     | Bits |
|               |                                    | Single-ended mode (see Note 1) |       | 10.4 |     | Bits |
| SFDR          | Spurious free dynamic range        | Differential mode              | 67    | 71   |     | dB   |
|               |                                    | Single-ended mode              |       | 69   |     | dB   |

**Analog Input**

|   |                          |  |    |  |     |
|---|--------------------------|--|----|--|-----|
| Full-power bandwidth with a source impedance of 150 $\Omega$ in differential configuration.   | FS sinewave, -3 dB       |  | 96 |  | MHz |
| Full-power bandwidth with a source impedance of 150 $\Omega$ in single-ended configuration.   | FS sinewave, -3 dB       |  | 54 |  | MHz |
| Small-signal bandwidth with a source impedance of 150 $\Omega$ in differential configuration. | 100 mVpp sinewave, -3 dB |  | 96 |  | MHz |
| Small-signal bandwidth with a source impedance of 150 $\Omega$ in single-ended configuration. | 100 mVpp sinewave, -3 dB |  | 54 |  | MHz |

NOTE 1: The SNR (ENOB) and SINAD is degraded typically by 2 dB in single-ended mode when the reading of data is asynchronous to the sampling clock.

timing specifications,  $AV_{DD}$  = 5 V,  $BV_{DD}$  =  $DV_{DD}$  = 3.3 V,  $V_{REF}$  = internal,  $C_L$  < 30 pF

| PARAMETER         |            | TEST CONDITIONS | MIN | TYP | MAX | UNIT        |
|-------------------|------------|-----------------|-----|-----|-----|-------------|
| $t_{d(DATA\_AV)}$ | Delay time |                 |     | 5   |     | ns          |
| $t_{d(o)}$        | Delay time |                 |     | 5   |     | ns          |
| $t_{pipe}$        | Latency    |                 |     | 5   |     | CONV<br>CLK |

**THS1206-EP**  
**12-BIT 6 MSPS, SIMULTANEOUS SAMPLING**  
**ANALOG-TO-DIGITAL CONVERTERS**

SGLS126A – JULY 2002 – REVISED FEBRUARY 2003

**timing specification of the single conversion mode†**

| PARAMETER              |  | TEST CONDITIONS          | MIN                            | TYP | MAX | UNIT |
|------------------------|--|--------------------------|--------------------------------|-----|-----|------|
| $t_c$                  | Clock cycle of the internal clock oscillator   |                          | 159                            | 167 | 175 | ns   |
| $t_1$                  | Pulse width, $\overline{\text{CONVST}}$  | 1 analog input           | $1.5 \times t_c$               |     |     | ns   |
|                        |  | 2 analog inputs          | $2.5 \times t_c$               |     |     |      |
|                        |  | 3 analog inputs          | $3.5 \times t_c$               |     |     |      |
|                        |  | 4 analog inputs          | $4.5 \times t_c$               |     |     |      |
| $t_{dA}$               | Aperture time  |                          | 1                              |     | ns  |      |
| $t_2$                  | Time between consecutive start of single conversion                                      | 1 analog input           | $2 \times t_c$                 |     |     | ns   |
|                        |  | 2 analog inputs          | $3 \times t_c$                 |     |     |      |
|                        |  | 3 analog inputs          | $4 \times t_c$                 |     |     | ns   |
|                        |  | 4 analog inputs          | $5 \times t_c$                 |     |     |      |
| $t_d(\text{DATA\_AV})$ | Delay time, DATA_AV becomes active for the trigger level condition: TRIG0 = 0, TRIG1 = 0 | 1 analog input, TL = 1   | $6 \times t_c$                 |     |     | ns   |
|                        |  | 2 analog inputs, TL = 2  | $7 \times t_c$                 |     |     |      |
|                        |  | 3 analog inputs, TL = 3  | $8 \times t_c$                 |     |     | ns   |
|                        |  | 4 analog inputs, TL = 4  | $9 \times t_c$                 |     |     |      |
|                        | Delay time, DATA_AV becomes active for the trigger level condition: TRIG0 = 1, TRIG1 = 0 | 1 analog input, TL = 4   | $3 \times t_2 + 6 \times t_c$  |     |     | ns   |
|                        |  | 2 analog inputs, TL = 4  | $t_2 + 7 \times t_c$           |     |     |      |
|                        |  | 3 analog inputs, TL = 6  | $t_2 + 8 \times t_c$           |     |     | ns   |
|                        |  | 4 analog inputs, TL = 8  | $t_2 + 9 \times t_c$           |     |     |      |
|                        | Delay time, DATA_AV becomes active for the trigger level condition: TRIG0 = 0, TRIG1 = 1 | 1 analog input, TL = 8   | $7 \times t_2 + 6 \times t_c$  |     |     | ns   |
|                        |  | 2 analog inputs, TL = 8  | $3 \times t_2 + 7 \times t_c$  |     |     |      |
|                        |  | 3 analog inputs, TL = 9  | $2 \times t_2 + 8 \times t_c$  |     |     | ns   |
|                        |  | 4 analog inputs, TL = 12 | $2 \times t_2 + 9 \times t_c$  |     |     |      |
| $t_d(\text{DATA\_AV})$ | Delay time, DATA_AV becomes active for the trigger level condition: TRIG0 = 1, TRIG1 = 1 | 1 analog input, TL = 14  | $13 \times t_2 + 6 \times t_c$ |     |     | ns   |
|                        |  | 2 analog inputs, TL = 12 | $5 \times t_2 + 7 \times t_c$  |     |     |      |
|                        |  | 3 analog inputs, TL = 12 | $3 \times t_2 + 8 \times t_c$  |     |     | ns   |

† Timing parameters are ensured by design but are not tested.

# THS1206-EP

## 12-BIT 6 MSPS, SIMULTANEOUS SAMPLING

### ANALOG-TO-DIGITAL CONVERTERS

SGLS126A – JULY 2002 – REVISED FEBRUARY 2003

#### detailed description

##### reference voltage

The THS1206 has a built-in reference, which provides the reference voltages for the ADC. VREFP is set to 3.5 V and VREFM is set to 1.5 V. An external reference can also be used through two reference input pins, REFP and REFM, if the reference source is programmed as external. The voltage levels applied to these pins establish the upper and lower limits of the analog inputs to produce a full-scale and zero-scale reading respectively.

##### analog inputs

The THS1206 consists of 4 analog inputs, which are sampled simultaneously. These inputs can be selected individually and configured as single-ended or differential inputs. The desired analog input channel can be programmed.

##### converter

The THS1206 uses a 12-bit pipelined multistaged architecture with 4 1-bit stages followed by 4 2-bit stages, which achieves a high sample rate with low power consumption. The THS1206 distributes the conversion over several smaller ADC sub-blocks, refining the conversion with progressively higher accuracy as the device passes the results from stage to stage. This distributed conversion requires a small fraction of the number of comparators used in a traditional flash ADC. A sample-and-hold amplifier (SHA) within each of the stages permits the first stage to operate on a new input sample while the second through the eighth stages operate on the seven preceding samples.

##### conversion modes

The conversion can be performed in two different conversion modes. In the single conversion mode, the conversion is initiated by an external signal ( $\overline{\text{CONVST}}$ ). An internal oscillator controls the conversion time. In the continuous conversion mode, an external clock signal is applied to the clock input (CONV\_CLK). A new conversion is started with every falling edge of the applied clock signal.

##### sampling rate

The maximum possible conversion rate per channel is dependent on the selected analog input channels. Table 1 shows the maximum conversion rate in the continuous conversion mode for different combinations.

**Table 1. Maximum Conversion Rate in Continuous Conversion Mode**

| CHANNEL CONFIGURATION                      | NUMBER OF CHANNELS | MAXIMUM CONVERSION RATE PER CHANNEL |
|--|--------------------|-------------------------------------|
| 1 single-ended channel                     | 1                  | 6 MSPS                              |
| 2 single-ended channels                    | 2                  | 3 MSPS                              |
| 3 single-ended channels                    | 3                  | 2 MSPS                              |
| 4 single-ended channels                    | 4                  | 1.5 MSPS                            |
| 1 differential channel                     | 1                  | 6 MSPS                              |
| 2 differential channels                    | 2                  | 3 MSPS                              |
| 1 single-ended and 1 differential channel  | 2                  | 3 MSPS                              |
| 2 single-ended and 1 differential channels | 3                  | 2 MSPS                              |

The maximum conversion rate in the continuous conversion mode per channel,  $f_c$ , is given by:

$$f_c = \frac{6 \text{ MSPS}}{\# \text{ channels}}$$



sampling rate (continued)

Table 2 shows the maximum conversion rate in the single conversion mode.

**Table 2. Maximum Conversion Rate in Single Conversion Mode**

| CHANNEL CONFIGURATION                      | NUMBER OF CHANNELS | MAXIMUM CONVERSION RATE PER CHANNEL |
|--|--------------------|-------------------------------------|
| 1 single-ended channel                     | 1                  | 3 MSPS                              |
| 2 single-ended channels                    | 2                  | 2 MSPS                              |
| 3 single-ended channels                    | 3                  | 1.5 MSPS                            |
| 4 single-ended channels                    | 4                  | 1.2 MSPS                            |
| 1 differential channel                     | 1                  | 3 MSPS                              |
| 2 differential channels                    | 2                  | 2 MSPS                              |
| 1 single-ended and 1 differential channel  | 2                  | 1.5 MSPS                            |
| 2 single-ended and 1 differential channels | 3                  | 1.2 MSPS                            |

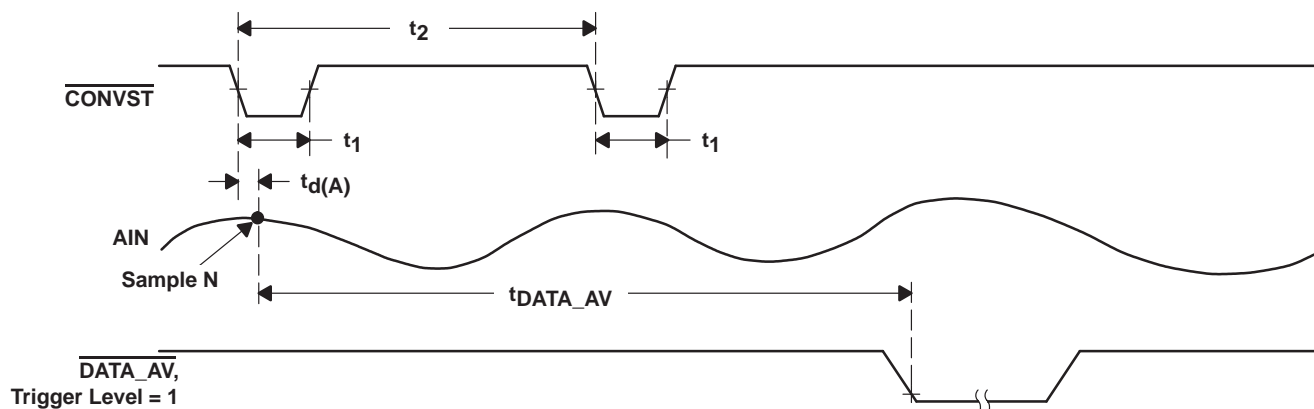
**single conversion mode**

In single conversion mode, a single conversion of the selected analog input channels is performed. The single conversion mode is selected by setting bit 1 of control register 0 to 1.

A single conversion is initiated by pulsing the  $\overline{\text{CONVST}}$  input. On the falling edge of  $\overline{\text{CONVST}}$ , the sample and hold stages of the selected analog inputs are placed into hold simultaneously, and the conversion sequence for the selected channels is started.

The conversion clock in single conversion mode is generated internally using a clock oscillator circuit. The signal  $\text{DATA\_AV}$  (data available) becomes active when the trigger level is reached and indicates that the converted sample(s) is (are) written into the FIFO and can be read out. The trigger level in the single conversion mode can be selected according to Table 13.

Figure 1 shows the timing of the single conversion mode. In this mode, up to four analog input channels can be selected to be sampled simultaneously (see Table 2).



**Figure 1. Timing of Single Conversion Mode**

The time ( $t_2$ ) between consecutive starts of single conversions is dependent on the number of selected analog input channels. The time  $t_{\text{DATA\_AV}}$ , until  $\text{DATA\_AV}$  becomes active is given by:  $t_{\text{DATA\_AV}} = t_{\text{pipe}} + n \times t_c$ . This equation is valid for a trigger level which is equivalent to the number of selected analog input channels. For all other trigger level conditions refer to the timing specifications of single conversion mode.

# THS1206-EP 12-BIT 6 MSPS, SIMULTANEOUS SAMPLING ANALOG-TO-DIGITAL CONVERTERS

SGLS126A – JULY 2002 – REVISED FEBRUARY 2003

## continuous conversion mode

The internal clock oscillator used in the single-conversion mode is switched off in continuous conversion mode. In continuous conversion mode, (bit 1 of control register 0 set to 0) the ADC operates with a free running external clock signal CONV\_CLK. With every rising edge of the CONV\_CLK signal a new converted value is written into the FIFO.

Figure 2 shows the timing of continuous conversion mode when one analog input channel is selected. The maximum throughput rate is 6 MSPS in this mode. The timing of the DATA\_AV signal is shown here in the case of a trigger level set to 1 or 4.

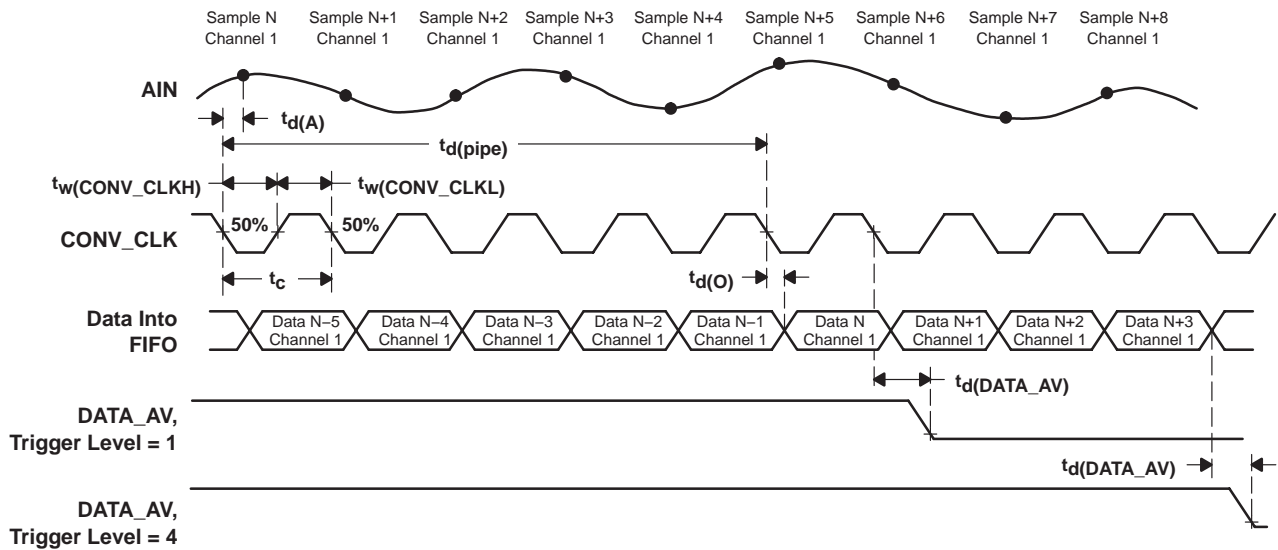


Figure 2. Timing of Continuous Conversion Mode (1-channel operation)

Figure 3 shows the timing of continuous conversion mode when two analog input channels are selected. The maximum throughput rate per channel is 3 MSPS in this mode. The data flow in the bottom of the figure shows the order the converted data is written into the FIFO. The timing of the DATA\_AV signal shown here is for a trigger level set to 2 or 4.

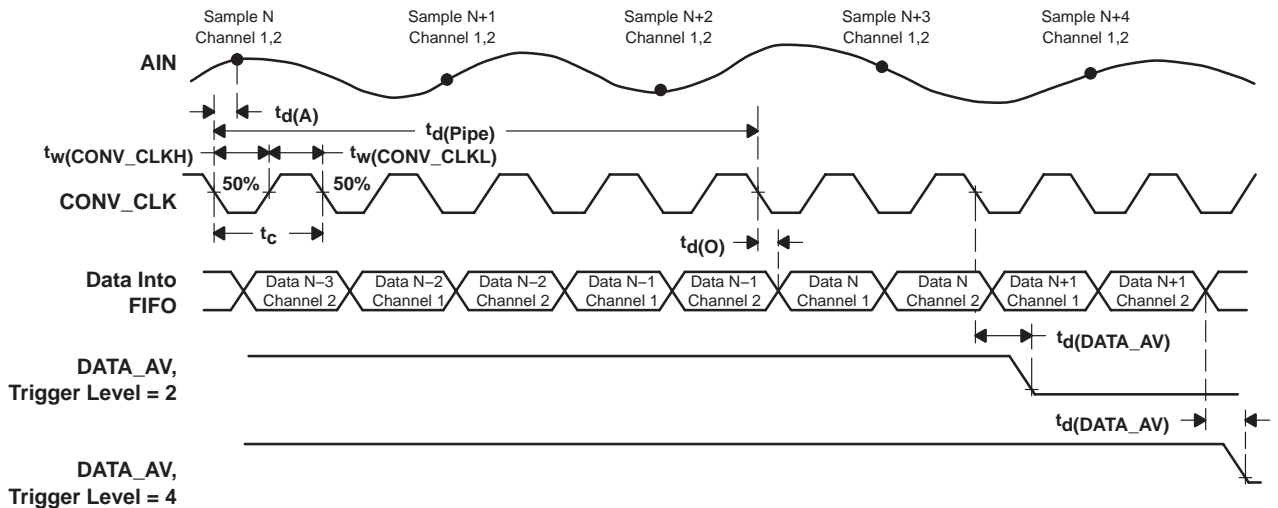
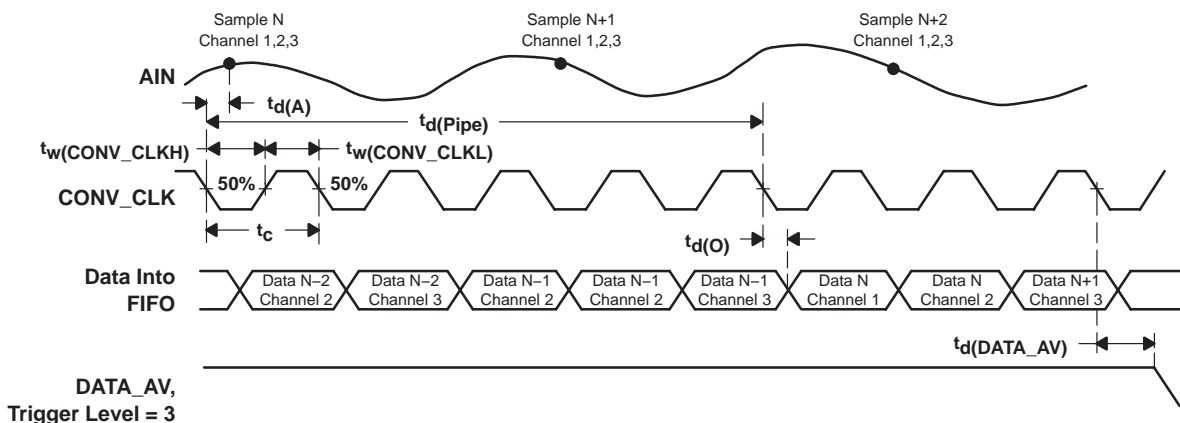


Figure 3. Timing of Continuous Conversion Mode (2-channel operation)



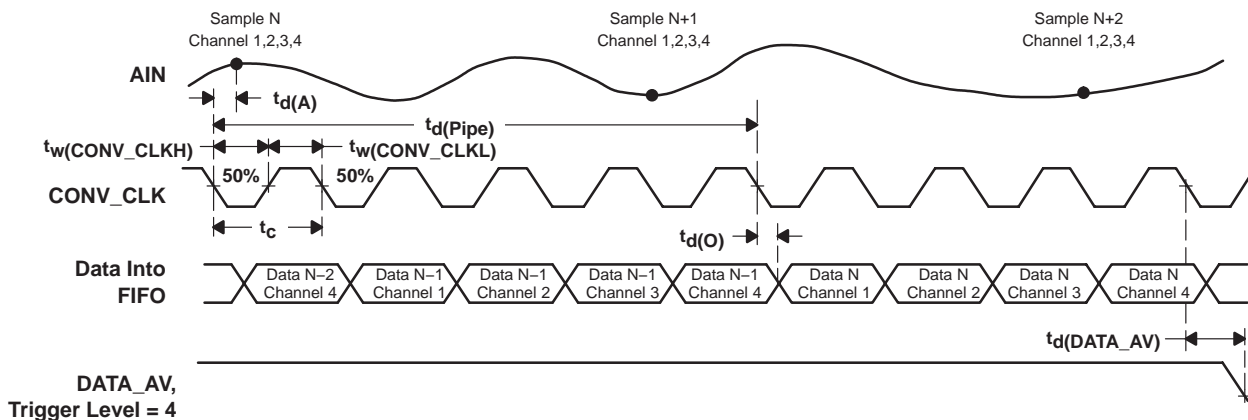
**continuous conversion mode (continued)**

Figure 4 shows the timing of continuous conversion mode when three analog input channels are selected. The maximum throughput rate per channel is 2 MSPS in this mode. The data flow in the bottom of the figure shows in which order the converted data is written into the FIFO. The timing of the DATA\_AV signal shown here is for a trigger level set to 3.



**Figure 4. Timing of Continuous Conversion Mode (3-channel operation)**

Figure 5 shows the timing of continuous conversion mode when four analog input channels are selected. The maximum throughput rate per channel is 1.5 MSPS in this mode. The data flow in the bottom of the figure shows in which order the converted data is written into the FIFO. The timing of the DATA\_AV signal shown here is for a trigger level of 4.



**Figure 5. Timing of Continuous Conversion Mode (4-channel operation)**

**THS1206-EP**  
**12-BIT 6 MSPS, SIMULTANEOUS SAMPLING**  
**ANALOG-TO-DIGITAL CONVERTERS**

SGLS126A – JULY 2002 – REVISED FEBRUARY 2003

**digital output data format**

The digital output data format of the THS1206 can either be in binary format or in twos complement format. The following tables list the digital outputs for the analog input voltages.

**Table 3. Binary Output Format for Single-Ended Configuration**

| SINGLE-ENDED, BINARY OUTPUT        |                     |
|------------------------------------|---------------------|
| ANALOG INPUT VOLTAGE               | DIGITAL OUTPUT CODE |
| $A_{IN} = V_{REFP}$                | FFFh                |
| $A_{IN} = (V_{REFP} + V_{REFM})/2$ | 800h                |
| $A_{IN} = V_{REFM}$                | 000h                |

**Table 4. Twos Complement Output Format for Single-Ended Configuration**

| SINGLE-ENDED, TWOS COMPLEMENT      |                     |
|------------------------------------|---------------------|
| ANALOG INPUT VOLTAGE               | DIGITAL OUTPUT CODE |
| $A_{IN} = V_{REFP}$                | 7FFh                |
| $A_{IN} = (V_{REFP} + V_{REFM})/2$ | 000h                |
| $A_{IN} = V_{REFM}$                | 800h                |

**Table 5. Binary Output Format for Differential Configuration**

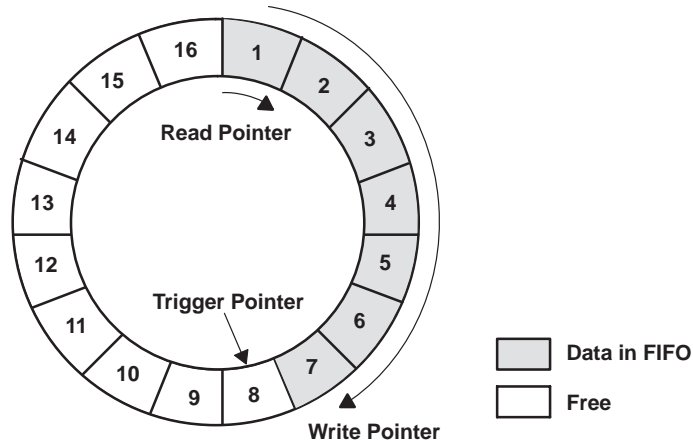
| DIFFERENTIAL, BINARY OUTPUT                                     |                     |
|---|---------------------|
| ANALOG INPUT VOLTAGE  | DIGITAL OUTPUT CODE |
| $V_{in} = A_{INP} - A_{INM}$<br>$V_{REF} = V_{REFP} - V_{REFM}$ |                     |
| $V_{in} = V_{REF}$  | FFFh                |
| $V_{in} = 0$  | 800h                |
| $V_{in} = -V_{REF}$   | 000h                |

**Table 6. Twos Complement Output Format for Differential Configuration**

| DIFFERENTIAL, BINARY OUTPUT                                     |                     |
|---|---------------------|
| ANALOG INPUT VOLTAGE  | DIGITAL OUTPUT CODE |
| $V_{in} = A_{INP} - A_{INM}$<br>$V_{REF} = V_{REFP} - V_{REFM}$ |                     |
| $V_{in} = V_{REF}$  | 7FFh                |
| $V_{in} = 0$  | 000h                |
| $V_{in} = -V_{REF}$   | 800h                |

## FIFO description

In order to facilitate an efficient connection to today's processors, the THS1206 is supplied with a FIFO. This integrated FIFO enables a problem-free processing of data with today's processors. The FIFO is provided as a flexible circular buffer. The circular buffer integrated in the THS1206 can store up to 16 conversion values. Therefore, the amount of interrupts to be served by a processor can be reduced significantly.



**Figure 6. Circular Buffer**

The converted data of the THS1206 is automatically written into the FIFO. To control the writing and reading process, a write pointer, a read pointer and a trigger pointer are used. The read pointer always shows the location which will be read next. The write pointer indicates the location which contains the last written sample. With a selection of multiple analog input channels, the converted values are written in a predefined sequence to the circular buffer (autoscan mode). In this way, the channel information for the reading processor is continually maintained.

The FIFO can be programmed through the control register of the ADC. The user has the ability to select a specific trigger level according to Table 13 in order to choose the configuration which best fits the application. The FIFO provides the signal DATA\_AV, which signals the processor to read the amount of data equal to the trigger level selected in Table 13. The signal DATA\_AV becomes active when the trigger condition is satisfied. The trigger condition is satisfied when as many values as selected for the trigger level where written into the FIFO.

The signal DATA\_AV could be connected to an interrupt input of a processor. In every interrupt service routine call, the processor must read the amount of data equal to the trigger level from the ADC. The first data represents the first channel according to the autoscan mode, which is shown in Table 10. The channel information is therefore always maintained.

# THS1206-EP

## 12-BIT 6 MSPS, SIMULTANEOUS SAMPLING

### ANALOG-TO-DIGITAL CONVERTERS

SGLS126A – JULY 2002 – REVISED FEBRUARY 2003

#### Reading data from the FIFO

The THS1206 informs the connected processor via the digital output DATA\_AV (data available) that a block of conversion values are ready to be read. The block size to be read is always equal to the setting of the trigger level. The selectable trigger levels depend on the number of selected analog input channels. For example, when choosing one analog input, a trigger level of 1, 4, 8 and 14 can be selected. The following figures demonstrate the principle of reading the data.

In Figure 7, a trigger level of 1 is selected. The control signal DATA\_AV is set to an active low pulse. This means that the connected processor has the task to read 1 value from the ADC after every DATA\_AV low pulse.

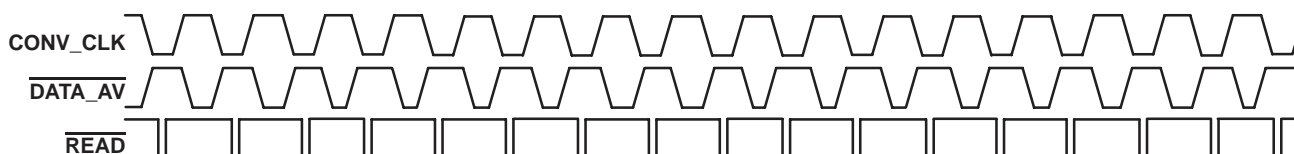


Figure 7. Trigger Level 1 Selected

In Figure 8, a trigger level of 4 is selected. The control signal DATA\_AV is set to an active low pulse. This means that the connected processor has the task to read 4 values from the ADC after every DATA\_AV low pulse.

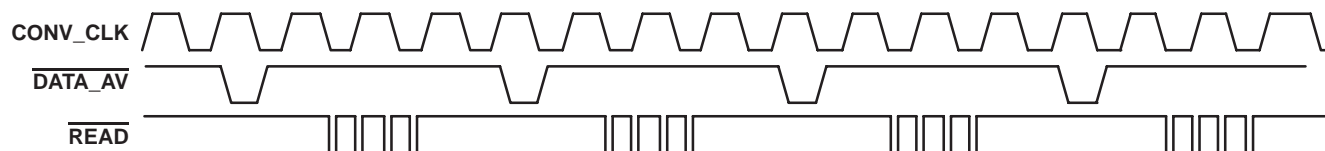


Figure 8. Trigger Level 4 Selected

In Figure 9, a trigger level of 8 is selected. The control signal DATA\_AV is set to an active low pulse. This means that the connected processor has the task to read 8 values from the ADC after every DATA\_AV low pulse.

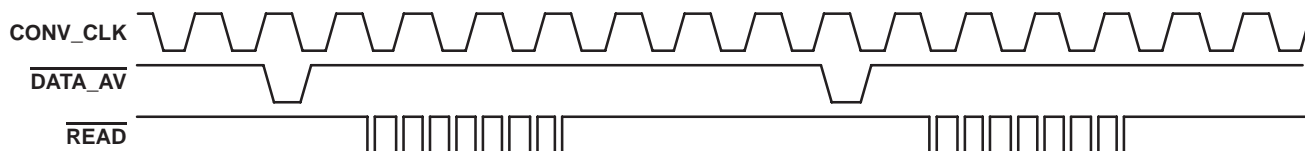


Figure 9. Trigger Level 8 Selected

In Figure 10, a trigger level of 14 is selected. The control signal DATA\_AV is set to an active low pulse. This means that the connected processor has the task to read 14 values from the ADC after every DATA\_AV low pulse.

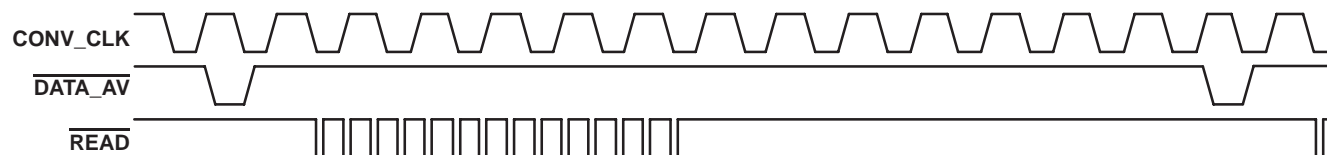


Figure 10. Trigger Level 14 Selected

READ is always the logical combination of  $\overline{CS0}$ , CS1 and  $\overline{RD}$ .

## ADC Control Register

The THS1206 contains two 10-bit wide control registers (CR0, CR1) in order to program the device into the desired mode. The bit definitions of both control registers are shown in Table 7.

**Table 7. Bit Definitions of Control Register CR0 and CR1**

| BIT        | BIT 9 | BIT 8  | BIT 7   | BIT 6 | BIT 5  | BIT 4  | BIT 3  | BIT 2 | BIT 1     | BIT 0 |
|------------|-------|--------|---------|-------|--------|--------|--------|-------|-----------|-------|
| <b>CR0</b> | TEST1 | TEST0  | SCAN    | DIFF1 | DIFF0  | CHSEL1 | CHSEL0 | PD    | MODE      | VREF  |
| <b>CR1</b> | RBACK | OFFSET | BIN/2's | R/W   | DATA_P | DATA_T | TRIG1  | TRIG0 | OVFL/FRST | RESET |

### Writing to control register 0 and control register 1

The 10-bit wide control register 0 and control register 1 can be programmed by addressing the desired control register and writing the register value to the ADC. The addressing is performed with the upper data bits D10 and D11, which function in this case as address lines RA0 and RA1. During this write process, the data bits D0 to D9 contain the desired control register value. Table 8 shows the addressing of each control register.

**Table 8. Control Register Addressing**

| D0 – D9                | D10/RA0 | D11/RA1 | Addressed Control Register |
|------------------------|---------|---------|----------------------------|
| Desired register value | 0       | 0       | Control Register 0         |
| Desired register value | 1       | 0       | Control Register 1         |
| Desired register value | 0       | 1       | Reserved for future        |
| Desired register value | 1       | 1       | Reserved for future        |

# THS1206-EP 12-BIT 6 MSPS, SIMULTANEOUS SAMPLING ANALOG-TO-DIGITAL CONVERTERS

SGLS126A – JULY 2002 – REVISED FEBRUARY 2003

## initialization of the THS1206

The initialization of the THS1206 should be done according to the configuration flow shown in Figure 11.

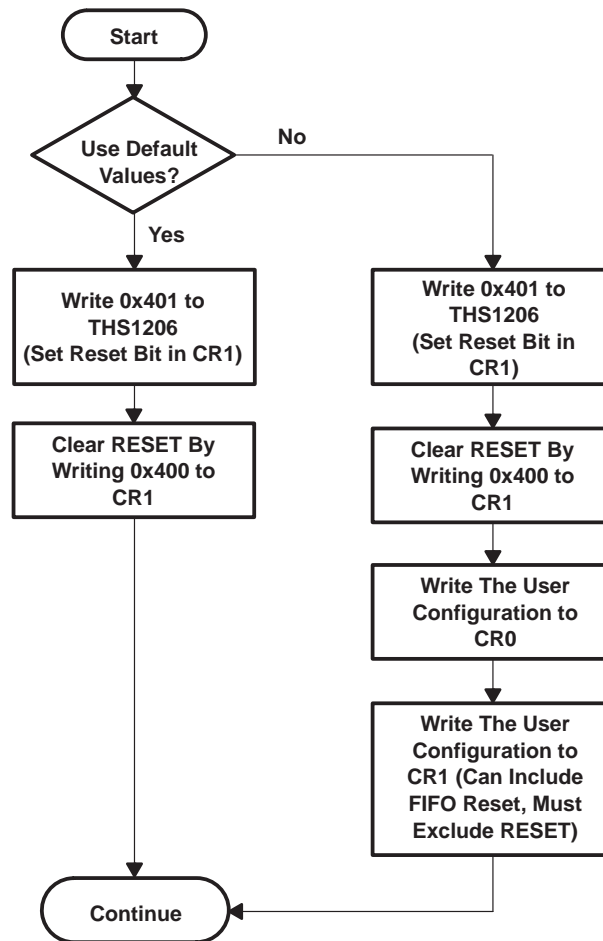


Figure 11. THS1206 Configuration Flow



## ADC control registers

### control register 0 (see Table 8)

|   |   |       |       |       |       |       |        |        |       |       |       |
|---|---|-------|-------|-------|-------|-------|--------|--------|-------|-------|-------|
| – | – | BIT 9 | BIT 8 | BIT 7 | BIT 6 | BIT 5 | BIT 4  | BIT 3  | BIT 2 | BIT 1 | BIT 0 |
| – | – | TEST1 | TEST0 | SCAN  | DIFF1 | DIFF0 | CHSEL1 | CHSEL0 | PD    | MODE  | VREF  |

**Table 9. Control Register 0 Bit Functions**

| BITS | RESET VALUE | NAME              | FUNCTION   |
|------|-------------|-------------------|--|
| 0    | 0           | VREF              | Vref select:<br>Bit 0 = 0 → The internal reference is selected<br>Bit 0 = 1 → The external reference voltage is selected   |
| 1    | 0           | MODE              | Continuous conversion mode/single conversion mode<br>Bit 1 = 0 → Continuous conversion mode is selected<br><br>An external clock signal is applied to the CONV_CLK input in this mode. With every falling edge of the CONV_CLK signal a new converted value is written into the FIFO.<br>Bit 1 = 1 → Single conversion mode is selected<br><br>In this mode, the CONV_CLK input functions as a CONVST input. A single conversion is initiated on the THS1206 by pulsing the CONVST input. On the falling edge of CONVST, the sample and hold stages of the selected analog inputs are placed into hold simultaneously, and the conversion sequence for the selected channels is started. The signal DATA_AV (data available) becomes active when the trigger condition is satisfied. |
| 2    | 0           | PD                | Power down.<br>Bit 2 = 0 → The ADC is active<br>Bit 2 = 1 → Power down<br><br>The reading and writing to and from the digital outputs is possible during power down. It is also possible to read out the FIFO.   |
| 3, 4 | 0,0         | CHSEL0,<br>CHSEL1 | Channel select<br>Bit 3 and bit 4 select the analog input channel of the ADC. Refer to Table 10.   |
| 5,6  | 1,0         | DIFF0, DIFF1      | Number of differential channels<br>Bit 5 and bit 6 contain information about the number of selected differential channels. Refer to Table 10.  |
| 7    | 0           | SCAN              | Autoscan enable<br>Bit 7 enables or disables the autoscan function of the ADC. Refer to Table 10.  |
| 8,9  | 0,0         | TEST0,<br>TEST1   | Test input enable<br>Bit 8 and bit 9 control the test function of the ADC. Three different test voltages can be measured. This feedback allows the check of all hardware connections and the ADC operation.<br><br>Refer to Table 11 for selection of the three different test voltages. The control signal DATA_AV is disabled in the test mode. Test voltage readings have to be done independent from DATA_AV. To get the THS1206 back to the normal operating mode, apply the the initialization routine.  |

**THS1206-EP**  
**12-BIT 6 MSPS, SIMULTANEOUS SAMPLING**  
**ANALOG-TO-DIGITAL CONVERTERS**

SGLS126A – JULY 2002 – REVISED FEBRUARY 2003

**analog input channel selection**

The analog input channels of the THS1206 can be selected via bits 3 to 7 of control register 0. One single channel (single-ended or differential) is selected via bit 3 and bit 4 of control register 0. Bit 5 controls the selection between single-ended and differential configuration. Bit 6 and bit 7 select the autoscan mode, if more than one input channel is selected. Table 10 shows the possible selections.

**Table 10. Analog Input Channel Configurations**

| BIT 7<br>SCAN | BIT 6<br>DIFF1 | BIT 5<br>DIFF0 | BIT 4<br>CHSEL1 | BIT 3<br>CHSEL0 | DESCRIPTION OF THE SELECTED INPUTS   |
|---------------|----------------|----------------|-----------------|-----------------|--|
| 0             | 0              | 0              | 0               | 0               | Analog input AINP (single ended)   |
| 0             | 0              | 0              | 0               | 1               | Analog input AINM (single ended)   |
| 0             | 0              | 0              | 1               | 0               | Analog input BINP (single ended)   |
| 0             | 0              | 0              | 1               | 1               | Analog input BINM (single ended)   |
| 0             | 0              | 1              | 0               | 0               | Differential channel (AINP–AINM)   |
| 0             | 0              | 1              | 0               | 1               | Differential channel (BINP–BINM)   |
| 1             | 0              | 0              | 0               | 1               | Autoscan two single ended channels: AINP, AINM, AINP, ...  |
| 1             | 0              | 0              | 1               | 0               | Autoscan three single ended channels: AINP, AINM, BINP, AINP, ...  |
| 1             | 0              | 0              | 1               | 1               | Autoscan four single ended channels: AINP, AINM, BINP, BINM, AINP, ...                                   |
| 1             | 0              | 1              | 0               | 1               | Autoscan one differential channel and one single ended channel AINP, (BINP–BINM), AINP, (BINP–BINM), ... |
| 1             | 0              | 1              | 1               | 0               | Autoscan one differential channel and two single ended channel AINP, AINM, (BINP–BINM), AINP, ...        |
| 1             | 1              | 0              | 0               | 1               | Autoscan two differential channels (AINP–AINM), (BINP–BINM), (AINP–AINM), ...                            |
| 0             | 0              | 1              | 1               | 0               | Reserved   |
| 0             | 0              | 1              | 1               | 1               | Reserved   |
| 1             | 0              | 0              | 0               | 0               | Reserved   |
| 1             | 0              | 1              | 0               | 0               | Reserved   |
| 1             | 0              | 1              | 1               | 1               | Reserved   |
| 1             | 1              | 0              | 0               | 0               | Reserved   |
| 1             | 1              | 0              | 1               | 0               | Reserved   |
| 1             | 1              | 0              | 1               | 1               | Reserved   |
| 1             | 1              | 1              | 0               | 0               | Reserved   |
| 1             | 1              | 1              | 0               | 1               | Reserved   |
| 1             | 1              | 1              | 1               | 0               | Reserved   |
| 1             | 1              | 1              | 1               | 1               | Reserved   |

**test mode**

The test mode of the ADC is selected via bit 8 and bit 9 of control register 0. The different selections are shown in Table 11.

**Table 11. Test Mode**

| BIT 9<br>TEST1 | BIT 8<br>TEST0 | OUTPUT RESULT               |
|----------------|----------------|-----------------------------|
| 0              | 0              | Normal mode                 |
| 0              | 1              | $V_{REFP}$                  |
| 1              | 0              | $((V_{REFM})+(V_{REFP}))/2$ |
| 1              | 1              | $V_{REFM}$                  |

Three different options can be selected. This feature allows support testing of hardware connections between the ADC and the processor.



**analog input channel selection (continued)**

**control register 1 (see Table 8)**

|   |   |       |        |        |       |        |        |       |       |           |       |
|---|---|-------|--------|--------|-------|--------|--------|-------|-------|-----------|-------|
| – | – | BIT 9 | BIT 8  | BIT 7  | BIT 6 | BIT 5  | BIT 4  | BIT 3 | BIT 2 | BIT 1     | BIT 0 |
| – | – | RBACK | OFFSET | BIN/2s | R/W   | DATA_P | DATA_T | TRIG1 | TRIG0 | OVFL/FRST | RESET |

**Table 12. Control Register 1 Bit Functions**

| BITS | RESET VALUE | NAME  | FUNCTION   |
|------|-------------|---|--|
| 0    | 0           | RESET   | Reset<br>Writing a 1 into this bit resets the device and sets the control register 0 and control register 1 to the reset values. In addition the FIFO pointer and offset register is reset. After reset, it takes 5 clock cycles until the first value is converted and written into the FIFO.   |
| 1    | 0           | OVFL<br>(read only)<br><br>FRST<br>(write only) | Overflow flag (read only)<br>Bit 1 of control register 1 indicates an overflow in the FIFO.<br>Bit 1 = 0 → no overflow occurred.<br>Bit 1 = 1 → an overflow occurred. This bit is reset to 0, after this control register is read from the processor.<br>FRST: FIFO reset (write only)<br>By writing a 1 into this bit, the FIFO is reset.   |
| 2, 3 | 0,0         | TRIG0,<br>TRIG1                                 | FIFO trigger level<br>Bit 2 and bit 3 of control register 1 are used to set the trigger level for the FIFO. If the trigger level is reached, the signal DATA_AV (data available) becomes active according to the settings of DATA_T and DATA_P. This indicates to the processor that the ADC values can be read. Refer to Table 13.  |
| 4    | 1           | DATA_T  | DATA_AV type<br>Bit 4 of control register 1 controls whether the DATA_AV signal is a pulse or static (e.g for edge or level sensitive interrupt inputs). If it is set to 0, the DATA_AV signal is static. If it is set to 1, the DATA_AV signal is a pulse. Refer to Table 14.   |
| 5    | 1           | DATA_P  | DATA_AV polarity<br>Bit 5 of control register 1 controls the polarity of DATA_AV. If it is set to 1, DATA_AV is active high. If it is set to 0, DATA_AV is active low. Refer to Table 14.  |
| 6    | 0           | R/W   | R/W, RD/WR selection<br>Bit 6 of control register 1 controls the function of the inputs $\overline{RD}$ and $\overline{WR}$ . When bit 6 in control register 1 is set to 1, $\overline{WR}$ becomes a R/W input and $\overline{RD}$ is disabled. From now on a read is signalled with R/W high and a write with R/W as a low signal. If bit 6 in control register 1 is set to 0, the input $\overline{RD}$ becomes a read input and the input $\overline{WR}$ becomes a write input.                               |
| 7    | 0           | BIN/2s  | Complement select<br>If bit 7 of control register 1 is set to 0, the output value of the ADC is in twos complement. If bit 7 of control register 1 is set to 1, the output value of the ADC is in binary format. Refer to Table 3 through Table 6.   |
| 8    | 0           | OFFSET  | Offset cancellation mode<br>Bit 8 = 0 → normal conversion mode<br>Bit 8 = 1 → offset calibration mode<br>If a 1 is written into bit 8 of control register 1, the device internally sets the inputs to zero and does a conversion. The conversion result is stored in an offset register and subtracted from all conversions in order to reduce the offset error.   |
| 9    | 0           | RBACK   | Debug mode<br>Bit 9 = 0 → normal conversion mode<br>Bit 9 = 1 → enable debug mode<br>When bit 9 of control register 1 is set to 1, debug mode is enabled. In this mode, the contents of control register 0 and control register 1 can be read back. The first read after bit 9 is set to 1 contains the value of control register 0. The second read after bit 9 is set to 1 contains the value of control register 1. To get the THS1206 back to the normal operating mode, apply the the initialization routine. |

# THS1206-EP

## 12-BIT 6 MSPS, SIMULTANEOUS SAMPLING

### ANALOG-TO-DIGITAL CONVERTERS

SGLS126A – JULY 2002 – REVISED FEBRUARY 2003

#### FIFO trigger level

Bit 2 and bit 3 (TRIG1, TRIG0) of control register 1 are used to set the trigger level of the FIFO (see Table 13). If the trigger level is reached, the DATA\_AV (data available) signal becomes active according to the setting of the signal DATA\_AV to indicate to the processor that the ADC values can be read.

Table 13 shows four different programmable trigger levels for each configuration. The FIFO trigger level, which can be selected, is dependent on the number of input channels. Both, a differential or a single-ended input is considered as one channel. The processor therefore always reads the data from the FIFO in the same order and is able to distinguish between the channels.

Table 13. FIFO Trigger Level

| BIT 3<br>TRIG1 | BIT 2<br>TRIG0 | TRIGGER LEVEL<br>FOR 1 CHANNEL<br>(ADC values) | TRIGGER LEVEL<br>FOR 2 CHANNELS<br>(ADC values) | TRIGGER LEVEL<br>FOR 3 CHANNEL<br>(ADC values) | TRIGGER LEVEL<br>FOR 4 CHANNELS<br>(ADC values) |
|----------------|----------------|--|---|--|---|
| 0              | 0              | 01   | 02  | 03   | 04  |
| 0              | 1              | 04   | 04  | 06   | 08  |
| 1              | 0              | 08   | 08  | 09   | 12  |
| 1              | 1              | 14   | 12  | 12   | Reserved  |

#### Timing and Signal Description of the THS1206

The reading from the THS1206 and writing to the THS1206 is performed by using the chip select inputs ( $\overline{CS0}$ , CS1), the write input  $\overline{WR}$  and the read input  $\overline{RD}$ . The write input is configurable to a combined read/write input ( $\overline{R/\overline{W}}$ ). This is desired in cases where the connected processor consists of a combined read/write output signal ( $\overline{R/\overline{W}}$ ). The two chip select inputs can be used to interface easily to a processor.

Reading from the THS1206 takes place by an internal  $\overline{RD}_{int}$  signal, which is generated from the logical combination of the external signals  $\overline{CS0}$ , CS1 and  $\overline{RD}$  (see Figure 12). This signal is then used to strobe the words out of the FIFO and to enable the output buffers. The last external signal (either  $\overline{CS0}$ , CS1 or  $\overline{RD}$ ) to become valid will make  $\overline{RD}_{int}$  active while the write input ( $\overline{WR}$ ) is inactive. The first of those external signals going to its inactive state will then deactivate  $\overline{RD}_{int}$  again.

Writing to the THS1206 takes place by an internal  $\overline{WR}_{int}$  signal, which is generated from the logical combination of the external signals  $\overline{CS0}$ , CS1 and  $\overline{WR}$ . This signal is then used to strobe the control words into the control registers 0 and 1. The last external signal (either  $\overline{CS0}$ , CS1 or  $\overline{WR}$ ) to become valid will make  $\overline{WR}_{int}$  active while the read input ( $\overline{RD}$ ) is inactive. The first of those external signals going to its inactive state will then deactivate  $\overline{WR}_{int}$  again.

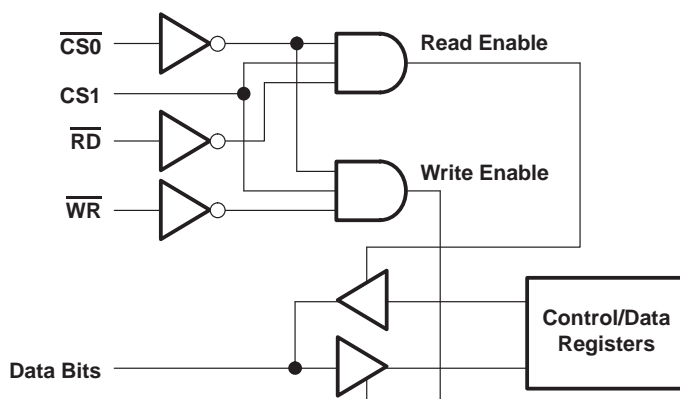


Figure 12. Logical Combination of  $\overline{CS0}$ , CS1,  $\overline{RD}$ , and  $\overline{WR}$

## DATA\_AV type

Bit 4 and bit 5 (DATA\_T, DATA\_P) of control register 1 are used to program the signal DATA\_AV. Bit 4 of control register 1 determines whether the DATA\_AV signal is static or a pulse. Bit 5 of the control register determines the polarity of DATA\_AV. This is shown in Table 14.

**Table 14. DATA\_AV Type**

| BIT 5<br>DATA_P | BIT 4<br>DATA_T | DATA_AV TYPE      |
|-----------------|-----------------|-------------------|
| 0               | 0               | Active low level  |
| 0               | 1               | Active low pulse  |
| 1               | 0               | Active high level |
| 1               | 1               | Active high pulse |

The signal DATA\_AV is set to active when the trigger condition is satisfied. It is set back inactive independent of the DATA\_T selection (pulse or level).

If level mode is chosen, DATA\_AV is set inactive after the first of the TL (TL = trigger level) reads (with the falling edge of READ). The trigger condition is checked again after TL reads.

If pulse mode is chosen, the signal DATA\_AV is a pulse with a width of one half of a CONV\_CLK cycle in continuous conversion mode and one half of a clock cycle of the internal oscillator in single conversion mode. The next DATA\_AV pulse (when the trigger condition is satisfied) is sent out the earliest, when the TL values, written into the FIFO before, were read out by the processor.

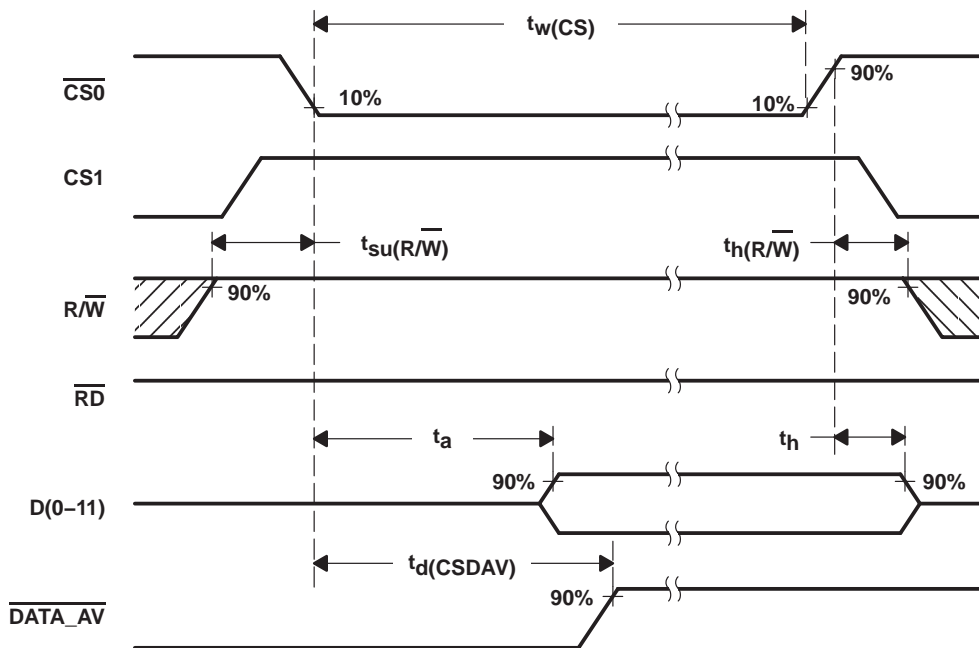
**THS1206-EP**  
**12-BIT 6 MSPS, SIMULTANEOUS SAMPLING**  
**ANALOG-TO-DIGITAL CONVERTERS**

SGLS126A – JULY 2002 – REVISED FEBRUARY 2003

**timing and signal description of the THS1206**

**read timing (using  $\overline{R/\overline{W}}$ ,  $\overline{CS0}$ -controlled)**

Figure 13 shows the read-timing behavior when the  $\overline{WR}(\overline{R/\overline{W}})$  input is programmed as a combined read-write input  $\overline{R/\overline{W}}$ . The  $\overline{RD}$  input has to be tied to high-level in this configuration. This timing is called  $\overline{CS0}$ -controlled because  $\overline{CS0}$  is the last external signal of  $\overline{CS0}$ ,  $CS1$ , and  $\overline{R/\overline{W}}$  which becomes valid.



**Figure 13. Read Timing Diagram Using  $\overline{R/\overline{W}}$  ( $\overline{CS0}$ -controlled)**

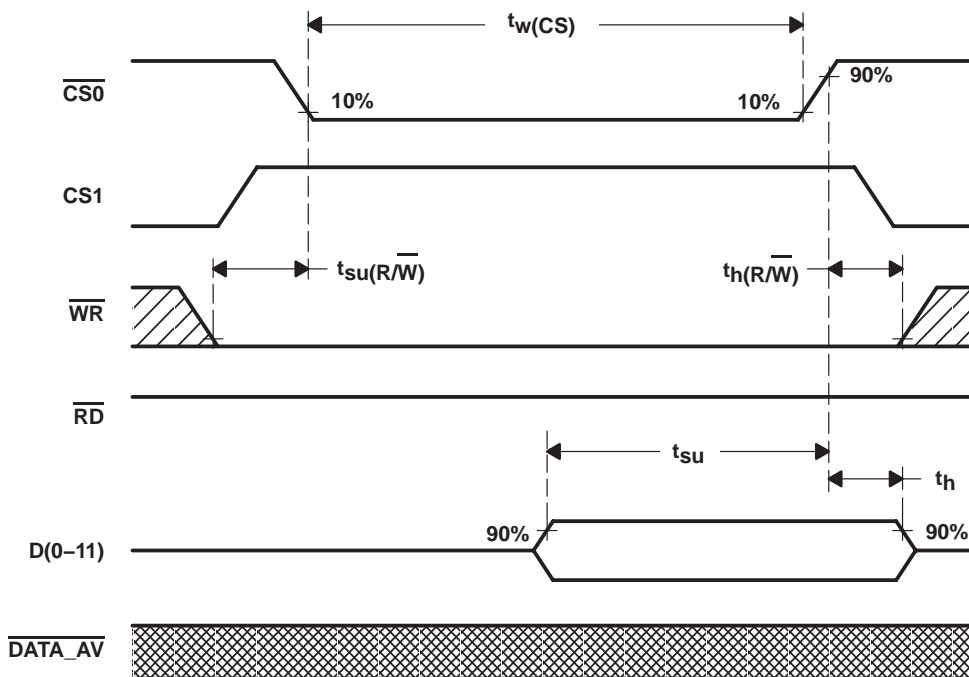
**read timing parameter ( $\overline{CS0}$ -controlled)**

| PARAMETER   | MIN | TYP | MAX | UNIT |
|---|-----|-----|-----|------|
| $t_{su}(\overline{R/\overline{W}})$ Setup time, $\overline{R/\overline{W}}$ high to last CS valid           | 0   |     |     | ns   |
| $t_a$ Access time, last CS valid to data valid  | 0   |     | 10  | ns   |
| $t_d(\overline{CSDAV})$ Delay time, last CS valid to $\overline{DATA\_AV}$ inactive                         |     | 12  |     | ns   |
| $t_h$ Hold time, first CS invalid to data invalid   | 0   |     | 5   | ns   |
| $t_h(\overline{R/\overline{W}})$ Hold time, first external CS invalid to $\overline{R/\overline{W}}$ change | 5   |     |     | ns   |
| $t_w(\overline{CS})$ Pulse duration, CS active  | 10  |     |     | ns   |

**timing and signal description of the THS1206 (continued)**

**write timing (using  $\overline{R/\overline{W}}$ ,  $\overline{CS0}$ -controlled)**

Figure 14 shows the write-timing behavior when the  $\overline{WR}(\overline{R/\overline{W}})$  input is programmed as a combined read-write input  $\overline{R/\overline{W}}$ . The  $\overline{RD}$  input has to be tied to high-level in this configuration. This timing is called  $\overline{CS0}$ -controlled because  $\overline{CS0}$  is the last external signal of  $\overline{CS0}$ ,  $\overline{CS1}$ , and  $\overline{R/\overline{W}}$  which becomes valid.



**Figure 14. Write Timing Diagram Using  $\overline{R/\overline{W}}$  ( $\overline{CS0}$ -controlled)**

**write timing parameter ( $\overline{RD}$ -controlled)**

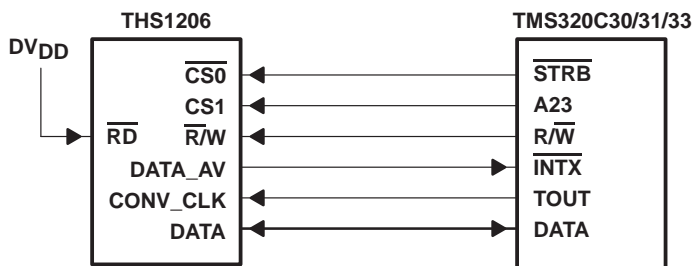
| PARAMETER                           |   | MIN | TYP | MAX | UNIT |
|-------------------------------------|---|-----|-----|-----|------|
| $t_{su}(\overline{R/\overline{W}})$ | Setup time, $\overline{R/\overline{W}}$ stable to last CS valid   | 0   |     |     | ns   |
| $t_{su}$                            | Setup time, data valid to first CS invalid                        | 5   |     |     | ns   |
| $t_h$                               | Hold time, first CS invalid to data invalid                       | 2   |     |     | ns   |
| $t_h(\overline{R/\overline{W}})$    | Hold time, first CS invalid to $\overline{R/\overline{W}}$ change | 5   |     |     | ns   |
| $t_w(\overline{CS})$                | Pulse duration, CS active   | 10  |     |     | ns   |

# THS1206-EP 12-BIT 6 MSPS, SIMULTANEOUS SAMPLING ANALOG-TO-DIGITAL CONVERTERS

SGLS126A – JULY 2002 – REVISED FEBRUARY 2003

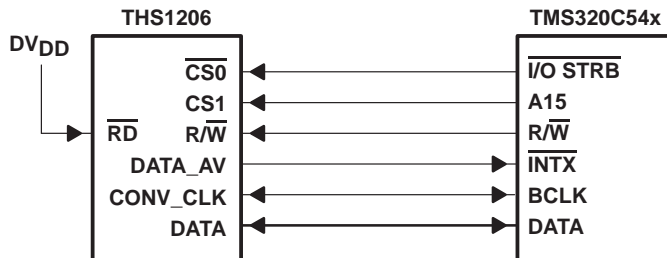
## interfacing the THS1206 to the TMS320C30/31/33 DSP

The following application circuit shows an interface of the THS1206 to the TMS320C30/31/33 DSPs. The read and write timings (using  $\overline{R/W}$ ,  $\overline{CS0}$ -controlled) shown before are valid for this specific interface.



## interfacing the THS1206 to the TMS320C54x using I/O strobe

The following application circuit shows an interface of the THS1206 to the TMS320C54x. The read and write timings (using  $\overline{R/W}$ ,  $\overline{CS0}$ -controlled) shown before are valid for this specific interface.

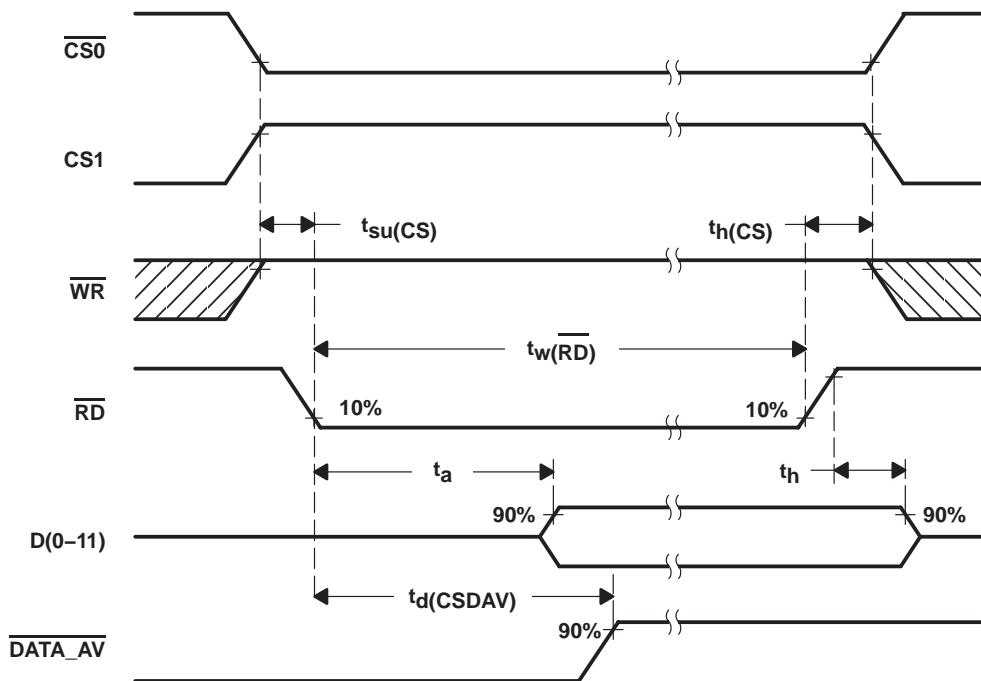




**timing and signal description of the THS1206 (continued)**

**read timing (using  $\overline{RD}$ ,  $\overline{RD}$ -controlled)**

Figure 15 shows the read-timing behavior when the  $\overline{WR}(R/\overline{W})$  input is programmed as a write-input only. The input  $\overline{RD}$  acts as the read-input in this configuration. This timing is called  $\overline{RD}$ -controlled because  $\overline{RD}$  is the last external signal of  $\overline{CS0}$ ,  $CS1$ , and  $\overline{RD}$  which becomes valid.



**Figure 15. Read Timing Diagram Using  $\overline{RD}$  ( $\overline{RD}$ -controlled)**

**read timing parameter ( $\overline{RD}$ -controlled)**

| PARAMETER            |   | MIN | TYP | MAX | UNIT |
|----------------------|---|-----|-----|-----|------|
| $t_{su}(CS)$         | Setup time, $\overline{RD}$ low to last CS valid      | 0   |     |     | ns   |
| $t_a$                | Access time, last CS valid to data valid              | 0   |     | 10  | ns   |
| $t_d(CSDAV)$         | Delay time, last CS valid to DATA_AV inactive         |     | 12  |     | ns   |
| $t_h$                | Hold time, first CS invalid to data invalid           | 0   |     | 5   | ns   |
| $t_h(\overline{CS})$ | Hold time, $\overline{RD}$ change to first CS invalid | 5   |     |     | ns   |
| $t_w(\overline{RD})$ | Pulse duration, $\overline{RD}$ active                | 10  |     |     | ns   |

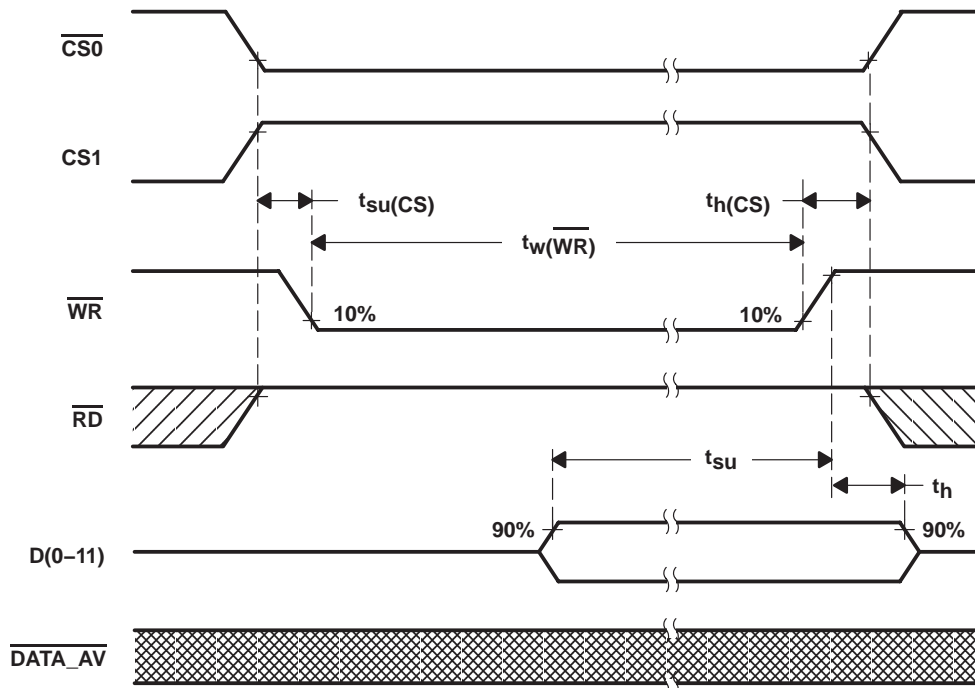
**THS1206-EP**  
**12-BIT 6 MSPS, SIMULTANEOUS SAMPLING**  
**ANALOG-TO-DIGITAL CONVERTERS**

SGLS126A – JULY 2002 – REVISED FEBRUARY 2003

**timing and signal description of the THS1206 (continued)**

**write timing (using  $\overline{WR}$ ,  $\overline{WR}$ -controlled)**

Figure 16 shows the write-timing behavior when the  $\overline{WR}(R/\overline{W})$  input is programmed as a write input  $\overline{WR}$  only. The input  $\overline{RD}$  acts as the read input in this configuration. This timing is called  $\overline{WR}$ -controlled because  $\overline{WR}$  is the last external signal of  $\overline{CS0}$ ,  $\overline{CS1}$ , and  $\overline{WR}$  which becomes valid.



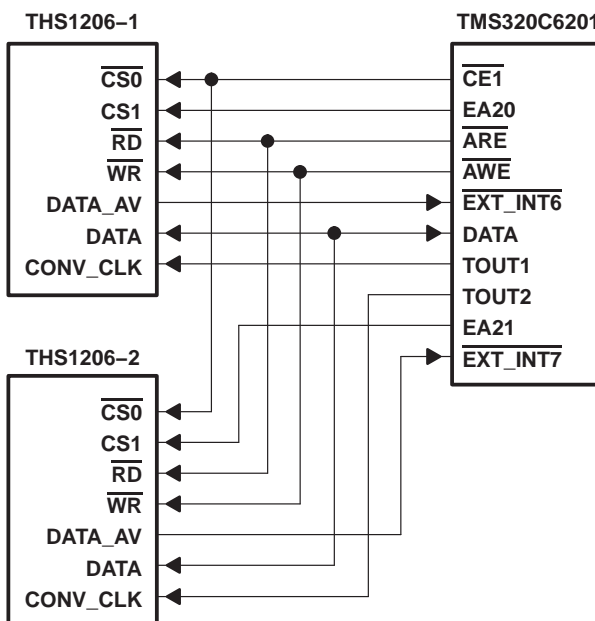
**Figure 16. Write Timing Diagram Using  $\overline{WR}$  ( $\overline{WR}$ -controlled)**

**write timing parameter using  $\overline{WR}$  ( $\overline{WR}$ -controlled)**

| PARAMETER            |   | MIN | TYP | MAX | UNIT |
|----------------------|---|-----|-----|-----|------|
| $t_{su}(CS)$         | Setup time, CS stable to last $\overline{WR}$ valid     | 0   |     |     | ns   |
| $t_{su}$             | Setup time, data valid to first $\overline{WR}$ invalid | 5   |     |     | ns   |
| $t_h$                | Hold time, $\overline{WR}$ invalid to data invalid      | 2   |     |     | ns   |
| $t_h(CS)$            | Hold time, $\overline{WR}$ invalid to CS change         | 5   |     |     | ns   |
| $t_w(\overline{WR})$ | Pulse duration, $\overline{WR}$ active                  | 10  |     |     | ns   |

### interfacing the THS1206 to the TMS320C6201 DSP

The following application circuit shows an interface of the THS1206 to the TMS320C6201. The read (using  $\overline{RD}$ ,  $\overline{RD}$ -controlled) and write timings (using  $\overline{WR}$ ,  $\overline{WR}$ -controlled) shown before are valid for this specific interface.



### analog input configuration and reference voltage

The THS1206 features four analog input channels. These can be configured for either single-ended or differential operation. Best performance is achieved in differential mode. Figure 17 shows a simplified model, where a single-ended configuration for channel AINP is selected. The reference voltages for the ADC itself are  $V_{REFP}$  and  $V_{REFM}$  (either internal or external reference voltage). The analog input voltage range goes from  $V_{REFM}$  to  $V_{REFP}$ . This means that  $V_{REFM}$  defines the minimum voltage, which can be applied to the ADC.  $V_{REFP}$  defines the maximum voltage, which can be applied to the ADC. The internal reference source provides the voltage  $V_{REFM}$  of 1.5 V and the voltage  $V_{REFP}$  of 3.5 V. The resulting analog input voltage swing of 2 V can be expressed by:

$$V_{REFM} \leq AINP \leq V_{REFP} \tag{1}$$

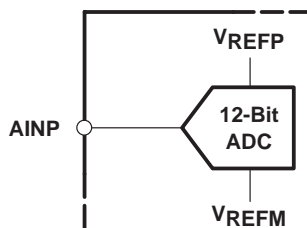


Figure 17. Single-Ended Input Stage

# THS1206-EP

## 12-BIT 6 MSPS, SIMULTANEOUS SAMPLING

### ANALOG-TO-DIGITAL CONVERTERS

SGLS126A – JULY 2002 – REVISED FEBRUARY 2003

#### analog input configuration and reference voltage (continued)

A differential operation is desired for many applications. Figure 18 shows a simplified model for the analog inputs AINM and AINP, which are configured for differential operation. This configuration has a few advantages, which are discussed in the following paragraphs.

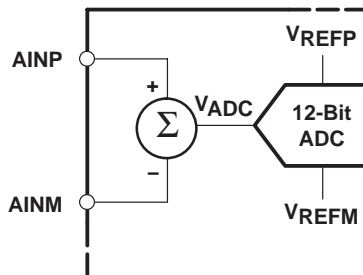


Figure 18. Differential Input Stage

In comparison to the single-ended configuration it can be seen that the voltage,  $V_{ADC}$ , which is applied at the input of the ADC is the difference between the input AINP and AINM. This means that  $V_{REFM}$  defines the minimum voltage ( $V_{ADC}$ ) which can be applied to the ADC.  $V_{REFP}$  defines the maximum voltage ( $V_{ADC}$ ) which can be applied to the ADC. The voltage  $V_{ADC}$  can be calculated as follows:

$$V_{ADC} = \text{ABS}(A_{INP} - A_{INM}) \quad (2)$$

An advantage to single-ended operation is that the common-mode voltage

$$V_{CM} = \frac{A_{INM} + A_{INP}}{2} \quad (3)$$

can be rejected in the differential configuration, if the following condition for the analog input voltages is true:

$$AGND \leq A_{INM}, A_{INP} \leq AV_{DD} \quad (4)$$

$$1 \text{ V} \leq V_{CM} \leq 4 \text{ V} \quad (5)$$

In addition to the common-mode voltage rejection, the differential operation allows a dc-offset rejection which is common to both analog inputs. See also Figure 20.

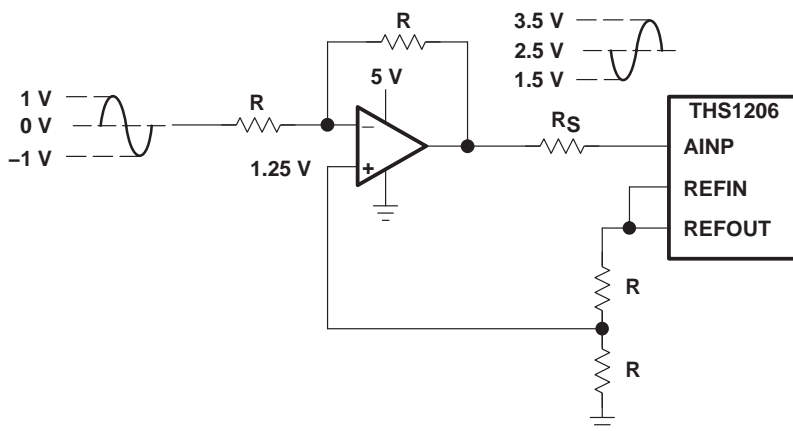
#### single-ended mode of operation

The THS1206 can be configured for single-ended operation using dc or ac coupling. In either case, the input of the THS1206 must be driven from an operational amplifier that does not degrade the ADC performance. Because the THS1206 operates from a 5-V single supply, it is necessary to level-shift ground-based bipolar signals to comply with its input requirements. This can be achieved with dc and ac coupling. An application example is shown for dc-coupled level shifting in the following section, dc coupling.

### dc coupling

An operational amplifier can be configured to shift the signal level according to the analog input voltage range of the THS1206. The analog input voltage range of the THS1206 goes from 1.5 V to 3.5 V. An op-amp specified for 5-V single supply can be used as shown in Figure 19.

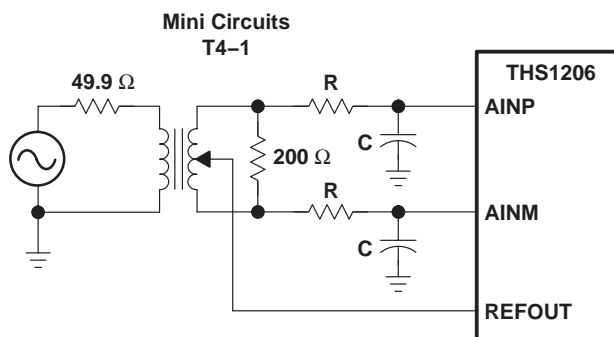
Figure 19 shows an application example where the analog input signal in the range from  $-1$  V up to  $1$  V is shifted by an op-amp to the analog input range of the THS1206 (1.5 V to 3.5 V). The op-amp is configured as an inverting amplifier with a gain of  $-1$ . The required dc voltage of 1.25 V at the noninverting input is derived from the 2.5-V output reference REFOUT of the THS1206 by using a resistor divider. Therefore, the op-amp output voltage is centered at 2.5 V. The use of ratio matched, thin-film resistor networks minimizes gain and offset errors.



**Figure 19. Level-Shift for DC-Coupled Input**

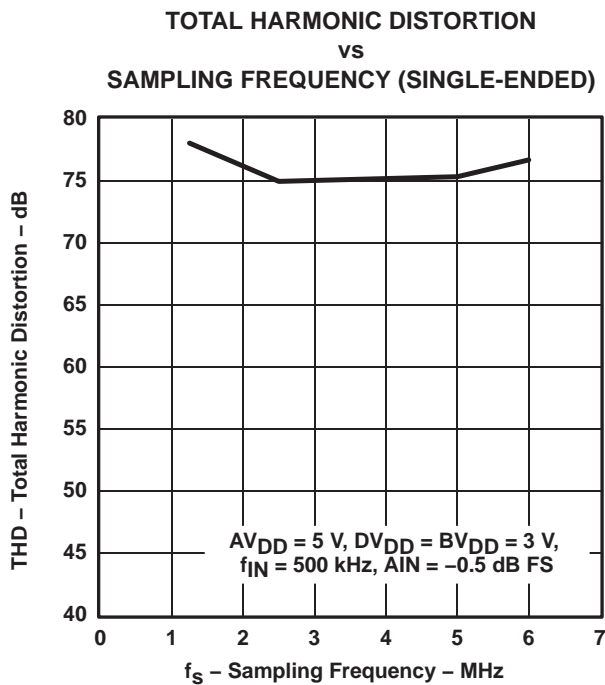
### differential mode of operation

For the differential mode of operation, a conversion from single-ended to differential is required. A conversion to differential signals can be achieved by using an RF-transformer, which provides a center tap. Best performance is achieved in differential mode.

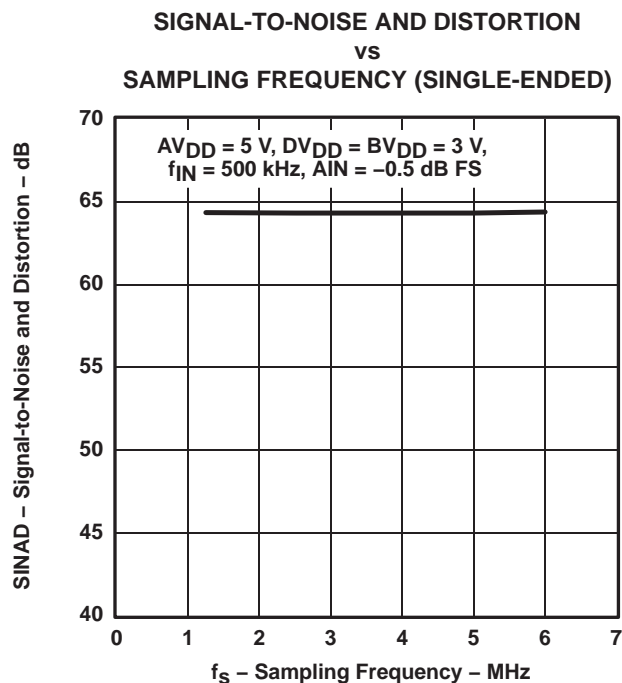


**Figure 20. Transformer Coupled Input**

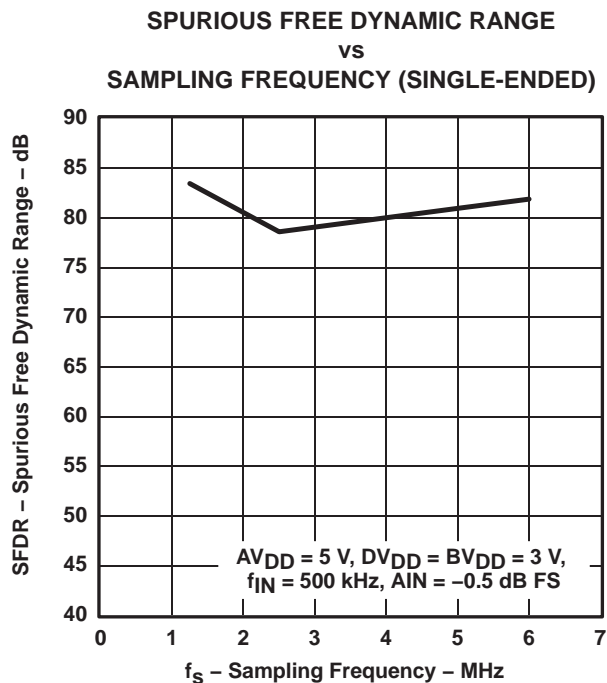
**TYPICAL CHARACTERISTICS**



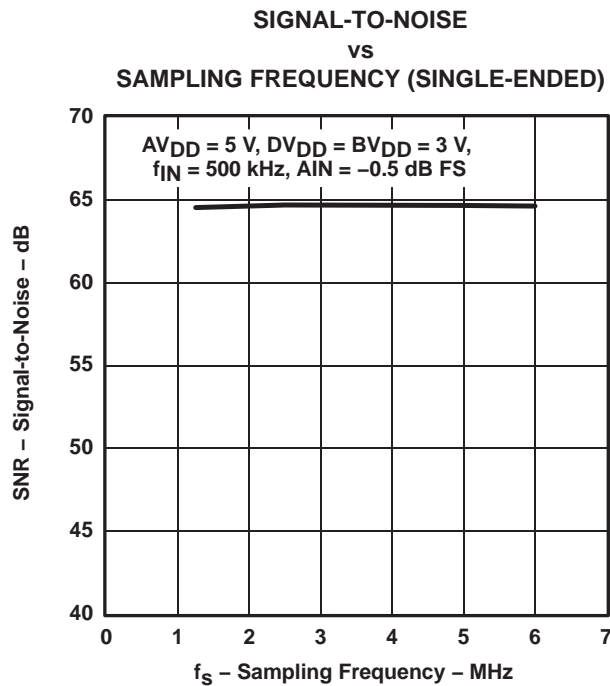
**Figure 21**



**Figure 22**

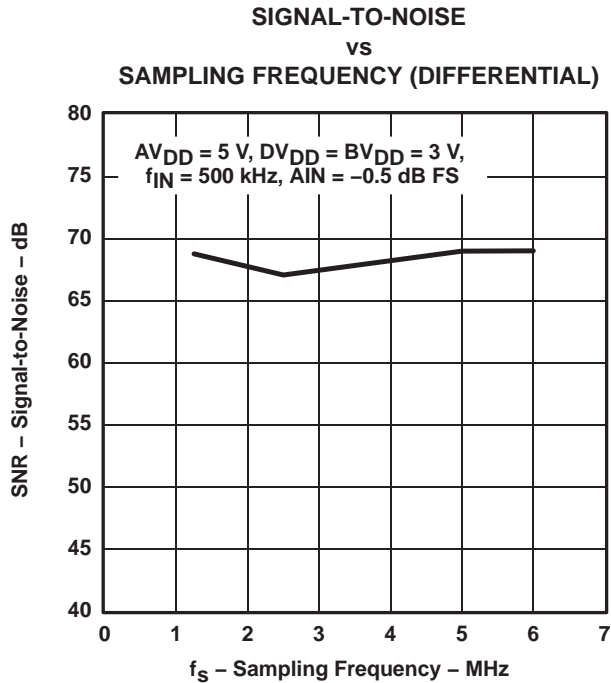
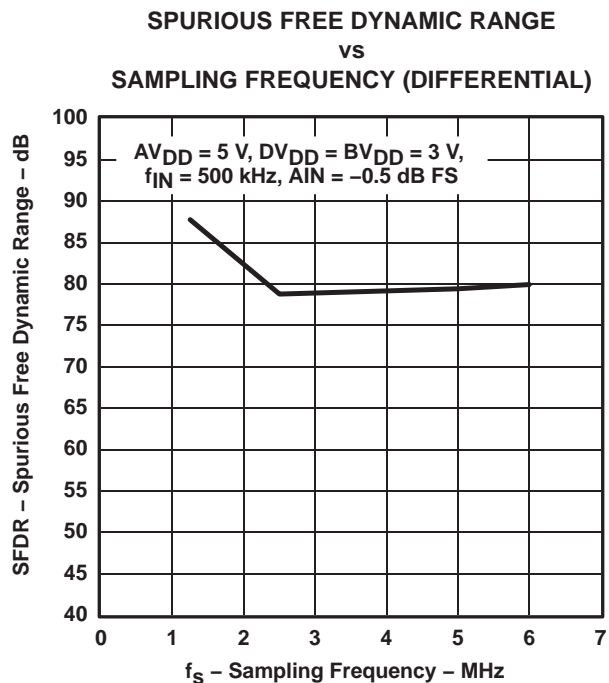
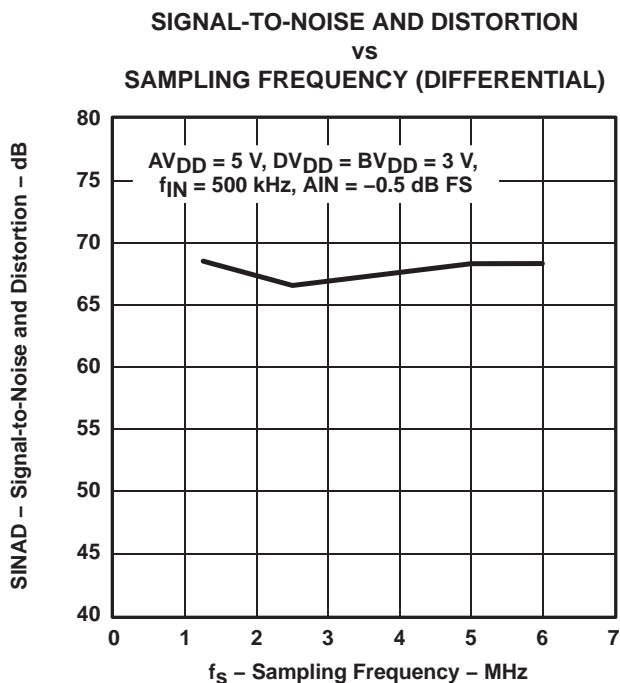
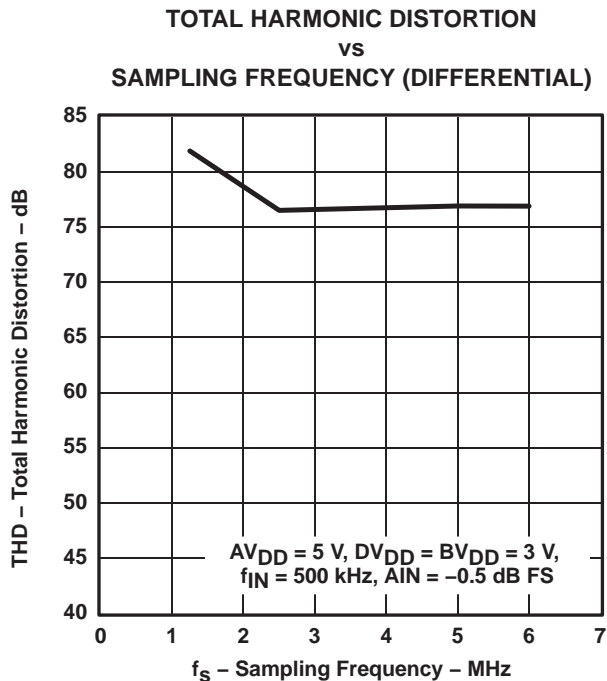


**Figure 23**



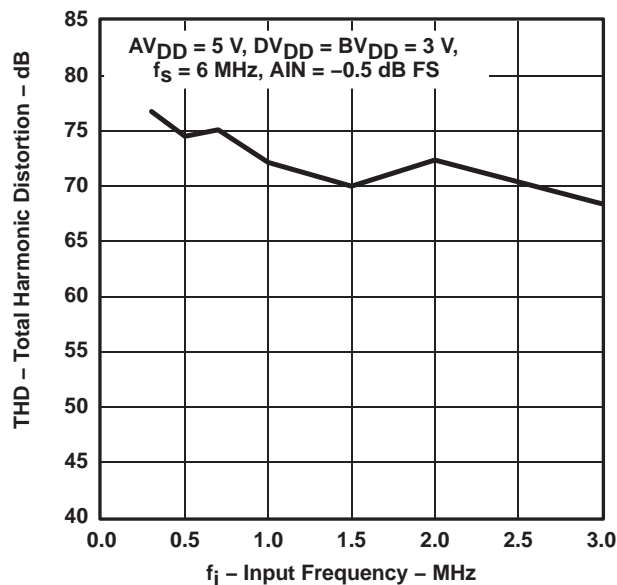
**Figure 24**

TYPICAL CHARACTERISTICS



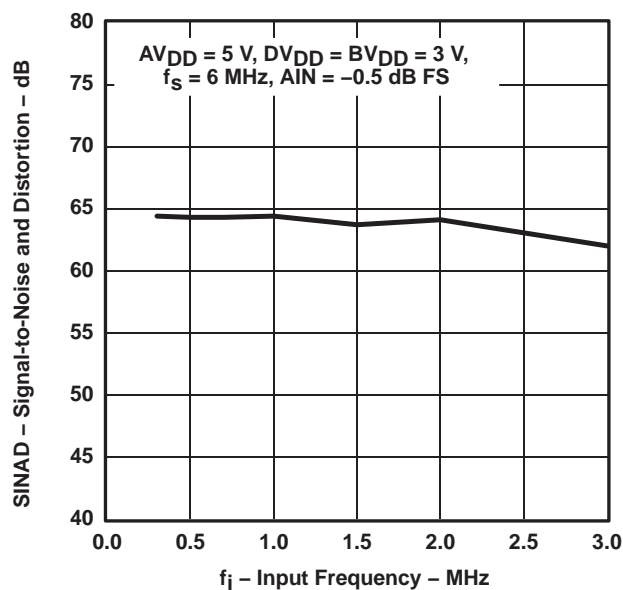
**TYPICAL CHARACTERISTICS**

**TOTAL HARMONIC DISTORTION**  
**vs**  
**INPUT FREQUENCY (SINGLE-ENDED)**



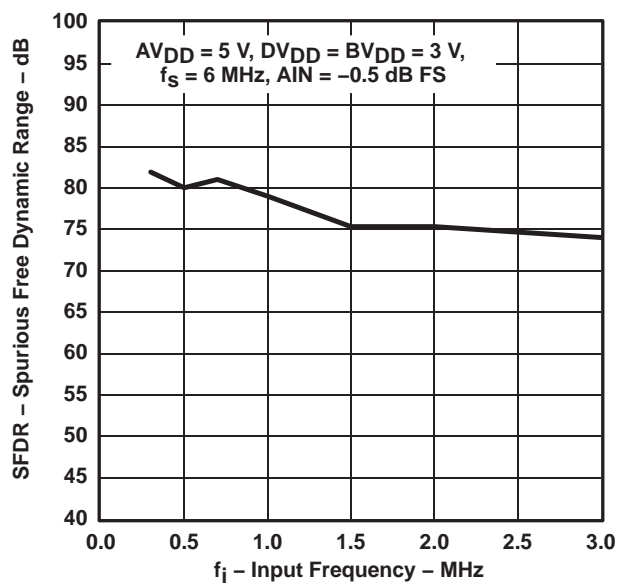
**Figure 29**

**SIGNAL-TO-NOISE AND DISTORTION**  
**vs**  
**INPUT FREQUENCY (SINGLE-ENDED)**



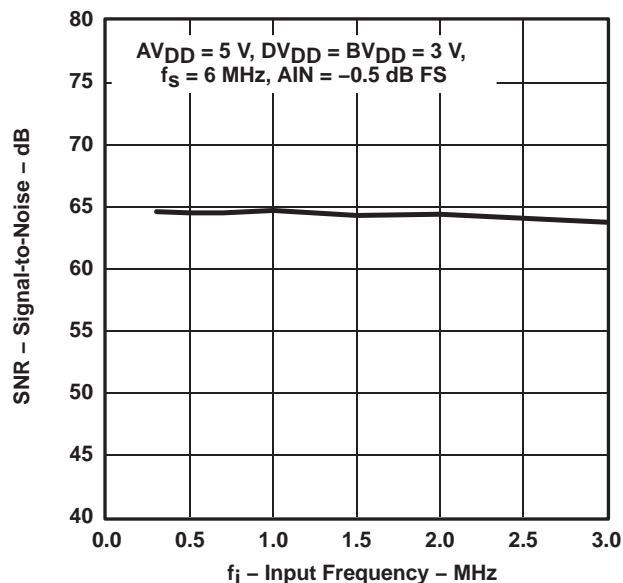
**Figure 30**

**SPURIOUS FREE DYNAMIC RANGE**  
**vs**  
**INPUT FREQUENCY (SINGLE-ENDED)**



**Figure 31**

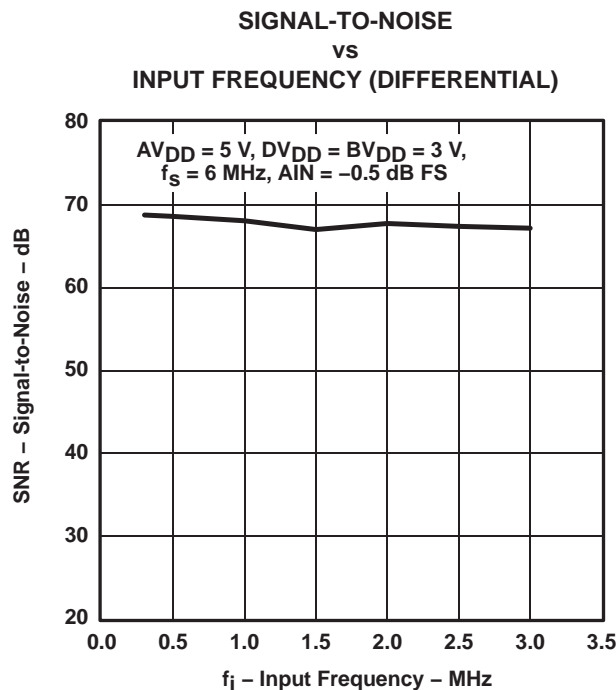
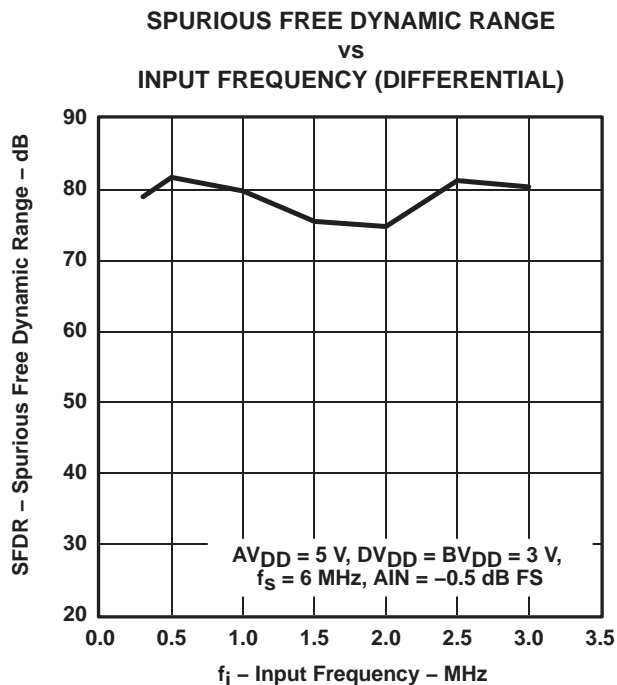
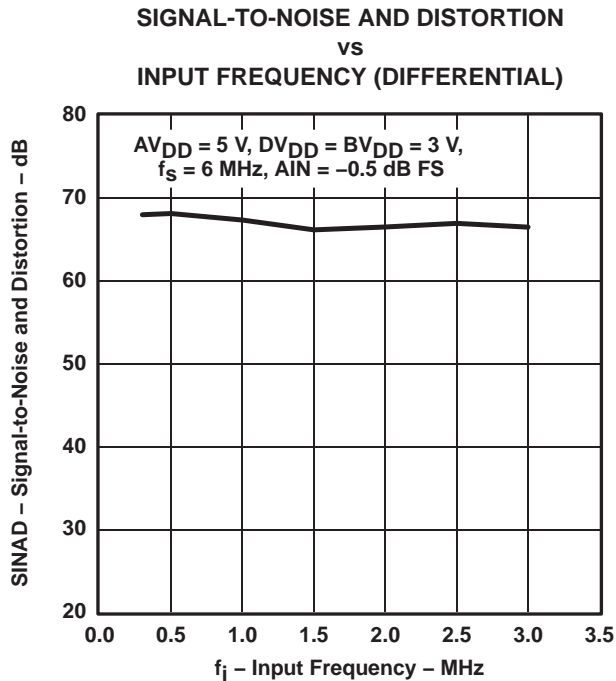
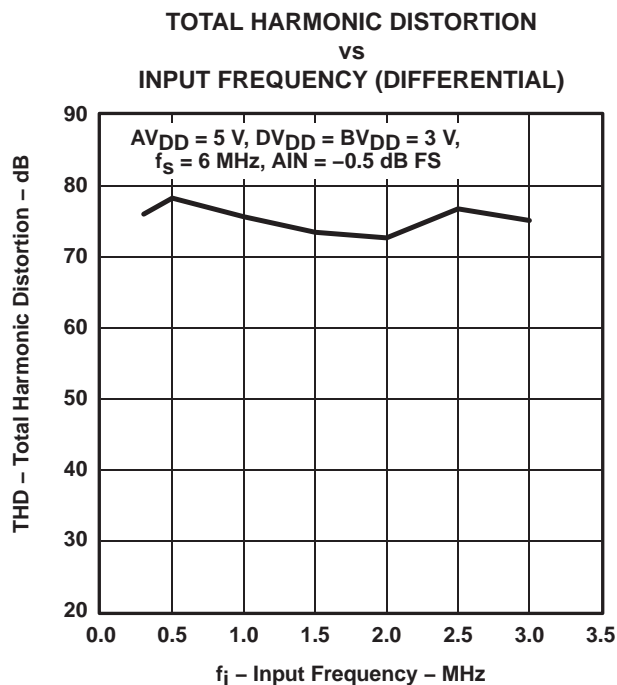
**SIGNAL-TO-NOISE**  
**vs**  
**INPUT FREQUENCY (SINGLE-ENDED)**



**Figure 32**

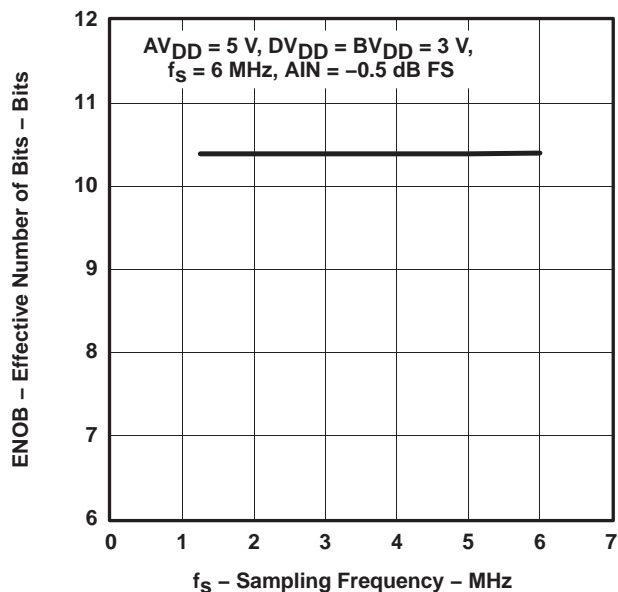


**TYPICAL CHARACTERISTICS**



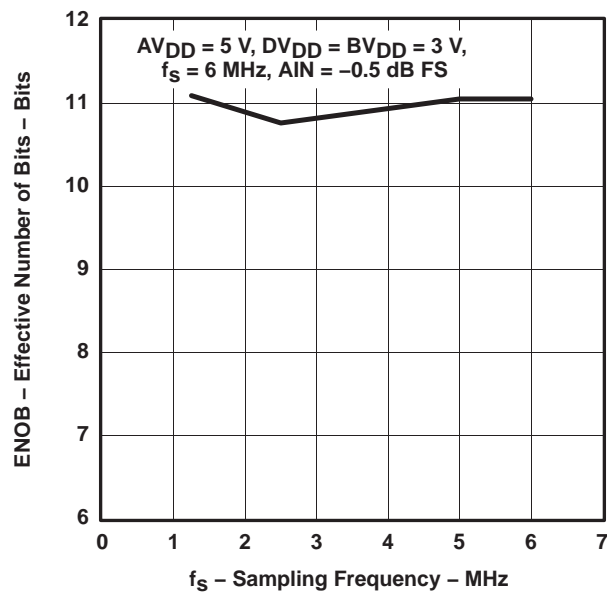
**TYPICAL CHARACTERISTICS**

**EFFECTIVE NUMBER OF BITS**  
**vs**  
**SAMPLING FREQUENCY (SINGLE-ENDED)**



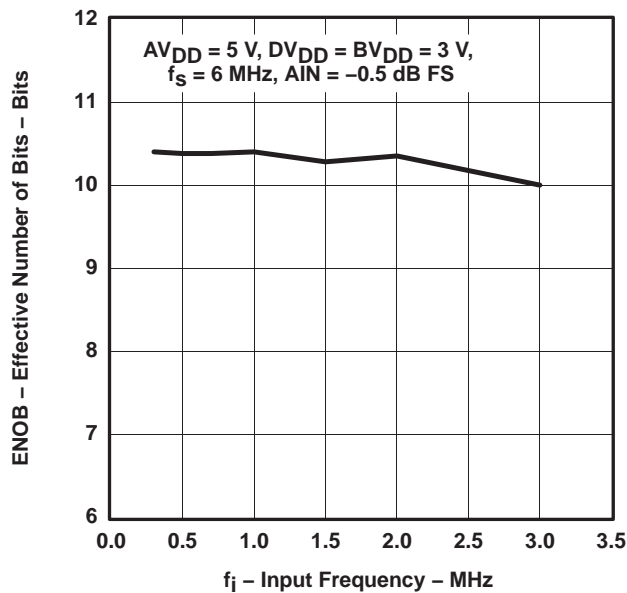
**Figure 37**

**EFFECTIVE NUMBER OF BITS**  
**vs**  
**SAMPLING FREQUENCY (DIFFERENTIAL)**



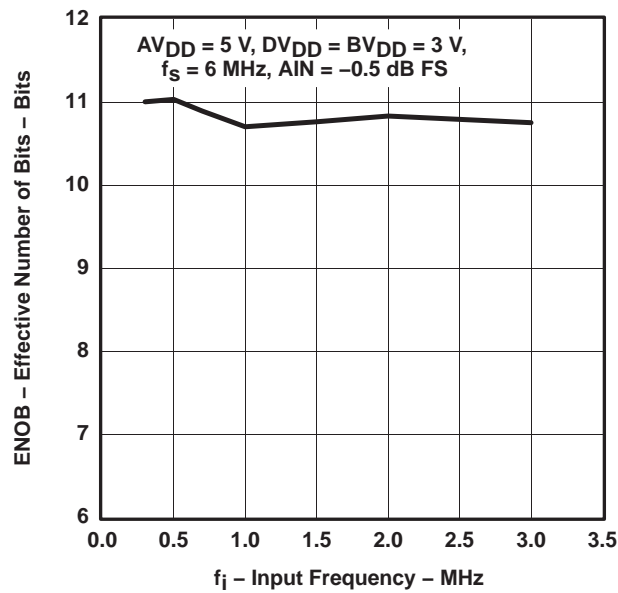
**Figure 38**

**EFFECTIVE NUMBER OF BITS**  
**vs**  
**INPUT FREQUENCY (SINGLE-ENDED)**



**Figure 39**

**EFFECTIVE NUMBER OF BITS**  
**vs**  
**INPUT FREQUENCY (DIFFERENTIAL)**



**Figure 40**

TYPICAL CHARACTERISTICS

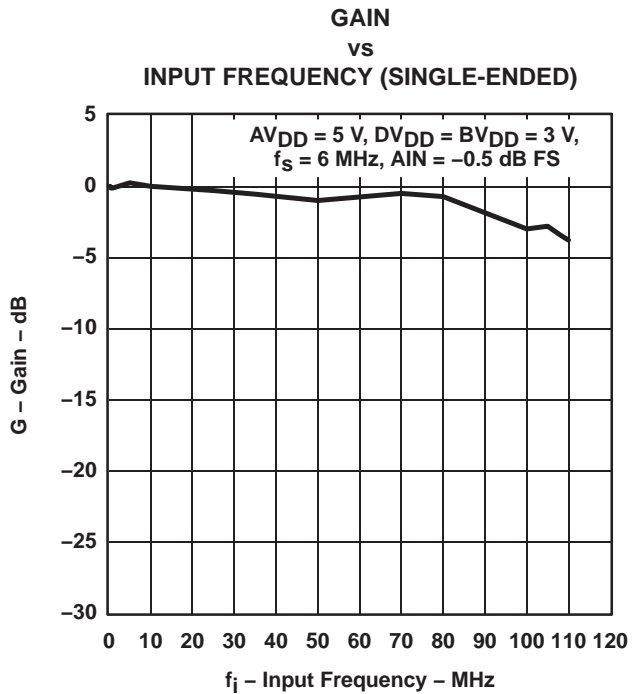


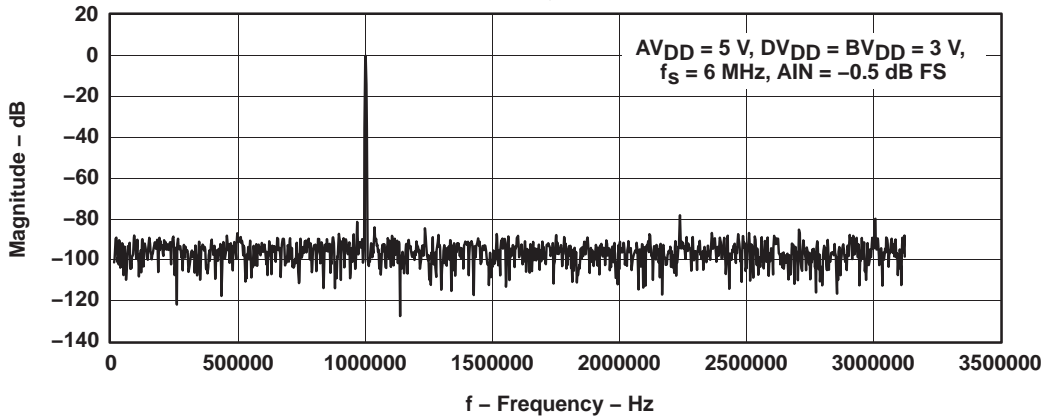
Figure 41

**THS1206-EP**  
**12-BIT 6 MSPS, SIMULTANEOUS SAMPLING**  
**ANALOG-TO-DIGITAL CONVERTERS**

SGLS126A – JULY 2002 – REVISED FEBRUARY 2003

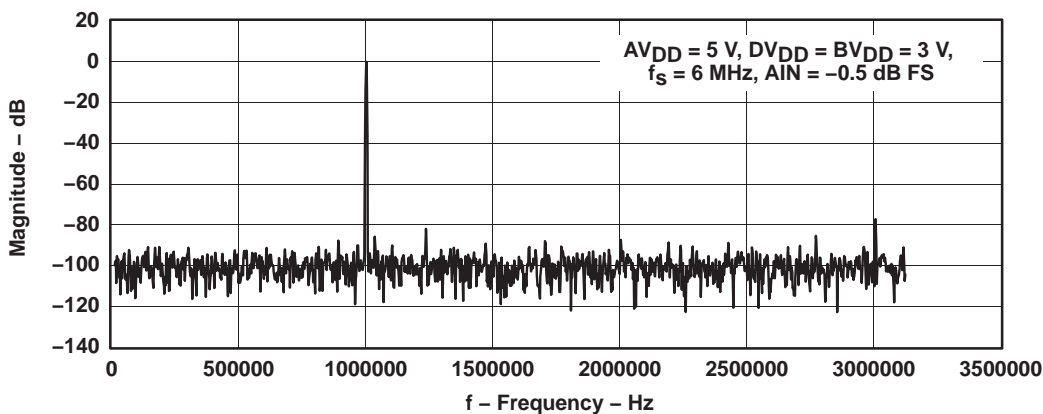
**TYPICAL CHARACTERISTICS**

**FAST FOURIER TRANSFORM (4096 POINTS)**  
**(SINGLE-ENDED)**  
vs  
**FREQUENCY**



**Figure 42**

**FAST FOURIER TRANSFORM (4096 POINTS)**  
**(DIFFERENTIAL)**  
vs  
**FREQUENCY**



**Figure 43**

## APPLICATION INFORMATION

### definitions of specifications and terminology

#### integral nonlinearity

Integral nonlinearity refers to the deviation of each individual code from a line drawn from zero through full scale. The point used as zero occurs 1/2 LSB before the first code transition. The full-scale point is defined as level 1/2 LSB beyond the last code transition. The deviation is measured from the center of each particular code to the true straight line between these two points.

#### differential nonlinearity

An ideal ADC exhibits code transitions that are exactly 1 LSB apart. DNL is the deviation from this ideal value. A differential nonlinearity error of less than  $\pm 1$  LSB ensures no missing codes.

#### zero offset

The major carry transition should occur when the analog input is at zero volts. Zero error is defined as the deviation of the actual transition from that point.

#### gain error

The first code transition should occur at an analog value 1/2 LSB above negative full scale. The last transition should occur at an analog value 1 1/2 LSB below the nominal full scale. Gain error is the deviation of the actual difference between first and last code transitions and the ideal difference between first and last code transitions.

#### signal-to-noise ratio + distortion (SINAD)

SINAD is the ratio of the rms value of the measured input signal to the rms sum of all other spectral components below the Nyquist frequency, including harmonics but excluding dc. The value for SINAD is expressed in decibels.

#### effective number of bits (ENOB)

For a sine wave, SINAD can be expressed in terms of the number of bits. Using the following formula,

$$N = \frac{(\text{SINAD} - 1.76)}{6.02}$$

it is possible to get a measure of performance expressed as N, the effective number of bits. Thus, effective number of bits for a device for sine wave inputs at a given input frequency can be calculated directly from its measured SINAD.

#### total harmonic distortion (THD)

THD is the ratio of the rms sum of the first six harmonic components to the rms value of the measured input signal and is expressed as a percentage or in decibels.

#### spurious free dynamic range (SFDR)

SFDR is the difference in dB between the rms amplitude of the input signal and the peak spurious signal.

**PACKAGING INFORMATION**

| Orderable part number          | Status<br>(1) | Material type<br>(2) | Package   Pins  | Package qty   Carrier | RoHS<br>(3) | Lead finish/<br>Ball material<br>(4) | MSL rating/<br>Peak reflow<br>(5) | Op temp (°C) | Part marking<br>(6) |
|--------------------------------|---------------|----------------------|-----------------|-----------------------|-------------|--------------------------------------|-----------------------------------|--------------|---------------------|
| <a href="#">THS1206MDAREP</a>  | Active        | Production           | TSSOP (DA)   32 | 2000   LARGE T&R      | Yes         | NIPDAU                               | Level-2-260C-1 YEAR               | -55 to 125   | THS1206MEP          |
| THS1206MDAREP.A                | Active        | Production           | TSSOP (DA)   32 | 2000   LARGE T&R      | Yes         | NIPDAU                               | Level-2-260C-1 YEAR               | -55 to 125   | THS1206MEP          |
| <a href="#">V62/03609-01XE</a> | Active        | Production           | TSSOP (DA)   32 | 2000   LARGE T&R      | Yes         | NIPDAU                               | Level-2-260C-1 YEAR               | -55 to 125   | THS1206MEP          |

(1) **Status:** For more details on status, see our [product life cycle](#).

(2) **Material type:** When designated, preproduction parts are prototypes/experimental devices, and are not yet approved or released for full production. Testing and final process, including without limitation quality assurance, reliability performance testing, and/or process qualification, may not yet be complete, and this item is subject to further changes or possible discontinuation. If available for ordering, purchases will be subject to an additional waiver at checkout, and are intended for early internal evaluation purposes only. These items are sold without warranties of any kind.

(3) **RoHS values:** Yes, No, RoHS Exempt. See the [TI RoHS Statement](#) for additional information and value definition.

(4) **Lead finish/Ball material:** Parts may have multiple material finish options. Finish options are separated by a vertical ruled line. Lead finish/Ball material values may wrap to two lines if the finish value exceeds the maximum column width.

(5) **MSL rating/Peak reflow:** The moisture sensitivity level ratings and peak solder (reflow) temperatures. In the event that a part has multiple moisture sensitivity ratings, only the lowest level per JEDEC standards is shown. Refer to the shipping label for the actual reflow temperature that will be used to mount the part to the printed circuit board.

(6) **Part marking:** There may be an additional marking, which relates to the logo, the lot trace code information, or the environmental category of the part.

Multiple part markings will be inside parentheses. Only one part marking contained in parentheses and separated by a "-" will appear on a part. If a line is indented then it is a continuation of the previous line and the two combined represent the entire part marking for that device.

**Important Information and Disclaimer:** The information provided on this page represents TI's knowledge and belief as of the date that it is provided. TI bases its knowledge and belief on information provided by third parties, and makes no representation or warranty as to the accuracy of such information. Efforts are underway to better integrate information from third parties. TI has taken and continues to take reasonable steps to provide representative and accurate information but may not have conducted destructive testing or chemical analysis on incoming materials and chemicals. TI and TI suppliers consider certain information to be proprietary, and thus CAS numbers and other limited information may not be available for release.

In no event shall TI's liability arising out of such information exceed the total purchase price of the TI part(s) at issue in this document sold by TI to Customer on an annual basis.

**OTHER QUALIFIED VERSIONS OF THS1206-EP :**

- Catalog : [THS1206](#)

- Military : [THS1206M](#)

NOTE: Qualified Version Definitions:

- Catalog - TI's standard catalog product
- Military - QML certified for Military and Defense Applications

**TAPE AND REEL INFORMATION**

**QUADRANT ASSIGNMENTS FOR PIN 1 ORIENTATION IN TAPE**


\*All dimensions are nominal

| Device        | Package Type | Package Drawing | Pins | SPQ  | Reel Diameter (mm) | Reel Width W1 (mm) | A0 (mm) | B0 (mm) | K0 (mm) | P1 (mm) | W (mm) | Pin1 Quadrant |
|---------------|--------------|-----------------|------|------|--------------------|--------------------|---------|---------|---------|---------|--------|---------------|
| THS1206MDAREP | TSSOP        | DA              | 32   | 2000 | 330.0              | 24.4               | 8.6     | 11.5    | 1.6     | 12.0    | 24.0   | Q1            |



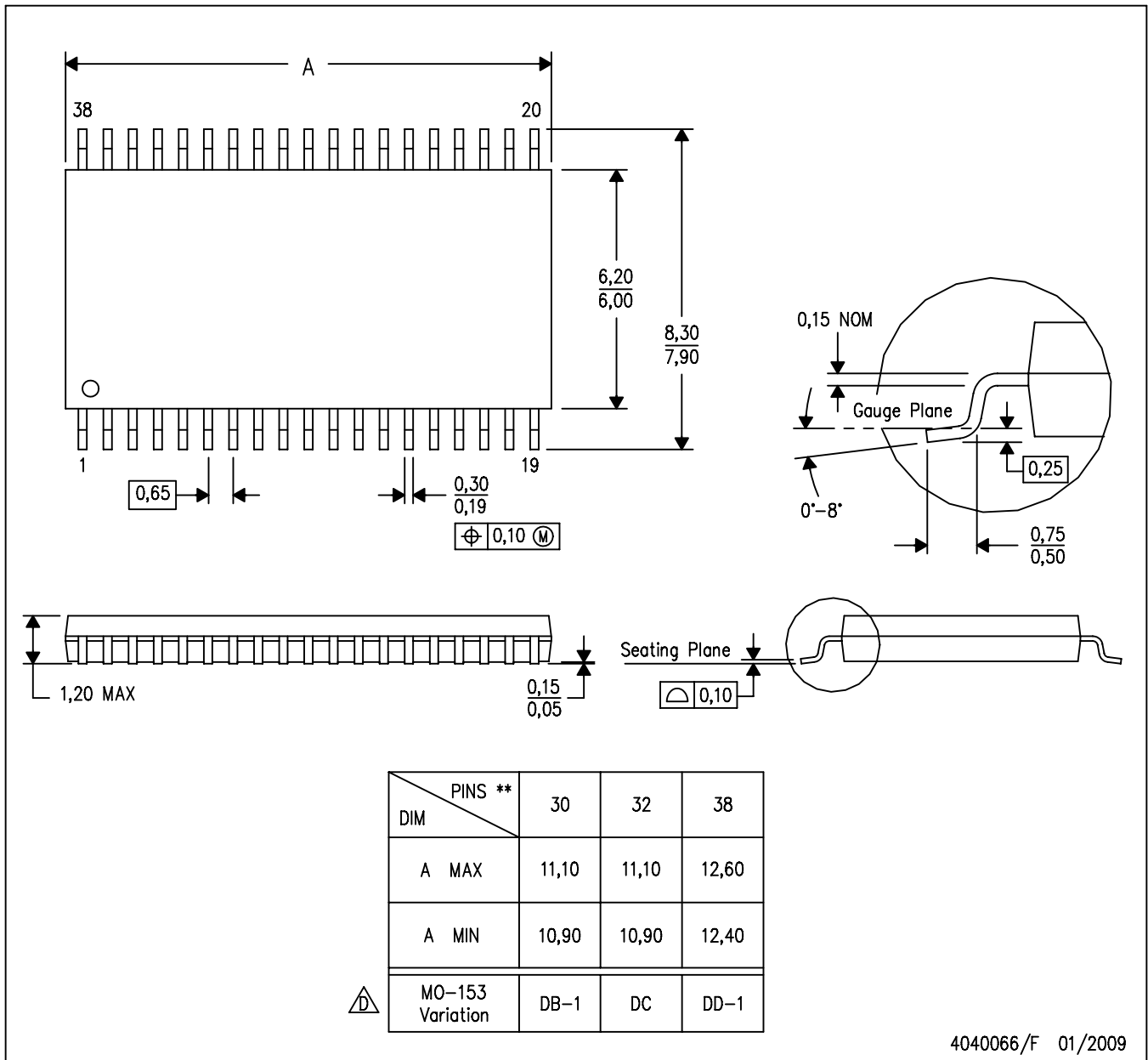
**TAPE AND REEL BOX DIMENSIONS**


\*All dimensions are nominal

| Device        | Package Type | Package Drawing | Pins | SPQ  | Length (mm) | Width (mm) | Height (mm) |
|---------------|--------------|-----------------|------|------|-------------|------------|-------------|
| THS1206MDAREP | TSSOP        | DA              | 32   | 2000 | 350.0       | 350.0      | 43.0        |

DA (R-PDSO-G\*\*)   
 38 PIN SHOWN

PLASTIC SMALL-OUTLINE PACKAGE



- NOTES:
- A. All linear dimensions are in millimeters.
  - B. This drawing is subject to change without notice.
  - C. Body dimensions do not include mold flash or protrusion. Mold flash and protrusion shall not exceed 0.15 per side.
  - Falls within JEDEC MO-153, except 30 pin body length.

## IMPORTANT NOTICE AND DISCLAIMER

TI PROVIDES TECHNICAL AND RELIABILITY DATA (INCLUDING DATASHEETS), DESIGN RESOURCES (INCLUDING REFERENCE DESIGNS), APPLICATION OR OTHER DESIGN ADVICE, WEB TOOLS, SAFETY INFORMATION, AND OTHER RESOURCES "AS IS" AND WITH ALL FAULTS, AND DISCLAIMS ALL WARRANTIES, EXPRESS AND IMPLIED, INCLUDING WITHOUT LIMITATION ANY IMPLIED WARRANTIES OF MERCHANTABILITY, FITNESS FOR A PARTICULAR PURPOSE OR NON-INFRINGEMENT OF THIRD PARTY INTELLECTUAL PROPERTY RIGHTS.

These resources are intended for skilled developers designing with TI products. You are solely responsible for (1) selecting the appropriate TI products for your application, (2) designing, validating and testing your application, and (3) ensuring your application meets applicable standards, and any other safety, security, regulatory or other requirements.

These resources are subject to change without notice. TI grants you permission to use these resources only for development of an application that uses the TI products described in the resource. Other reproduction and display of these resources is prohibited. No license is granted to any other TI intellectual property right or to any third party intellectual property right. TI disclaims responsibility for, and you fully indemnify TI and its representatives against any claims, damages, costs, losses, and liabilities arising out of your use of these resources.

TI's products are provided subject to [TI's Terms of Sale](#), [TI's General Quality Guidelines](#), or other applicable terms available either on [ti.com](http://ti.com) or provided in conjunction with such TI products. TI's provision of these resources does not expand or otherwise alter TI's applicable warranties or warranty disclaimers for TI products. Unless TI explicitly designates a product as custom or customer-specified, TI products are standard, catalog, general purpose devices.

TI objects to and rejects any additional or different terms you may propose.

Copyright © 2025, Texas Instruments Incorporated

Last updated 10/2025