

Low Voltage 5-Bit Self-Timed, Single-Wire Output Expander

Check for Samples: [TCA5405](#)

FEATURES

- Operating Power-Supply Voltage Range of 1.65 V to 3.6 V
- Five Independent Push-Pull Outputs
- Single Input (DIN) Controls State of All Outputs
- High-Current Drive Outputs Maximum Capability for Directly Driving LEDs
- Latch-Up Performance Exceeds 100 mA Per JESD 78, Class II
- ESD Protection Exceeds JESD 22
 - 2000-V Human-Body Model (A114-A)
 - 1000-V Charged-Device Model (C101)

RUG PACKAGE (TOP VIEW)

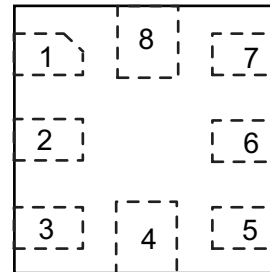

PIN #	NAME	COMMENTS
1	VCC	Supply Voltage
2	DIN	Data Input
3	GND	Ground
4	Q0	GPO
5	Q1	GPO
6	Q2	GPO
7	Q3	GPO
8	Q4	GPO

APPLICATIONS

- Cell Phones
- PDAs
- Portable Media Players
- MP3 Players
- Portable Instrumentation

DESCRIPTION

The TCA5405 is a 5-bit output expander controlled using a single wire input. This device is ideal for portable applications as it has a wide VCC range of 1.65V to 3.6 V. The TCA5405 uses a self-timed serial data protocol with a single data input driven by a master device synchronized to an internal clock of that device. During a Setup phase, the bit period is sampled, then the TCA5405 generates its own internal clock synchronized to that of the Master device to sample the input over a five-bit-period Data Transfer phase and writes the bit states on the parallel outputs after the last bit is sampled. The TCA5405 is available in an 8-pin 1.5mm x 1.5mm RUG uQFN package.

ORDERING INFORMATION

T _A	PACKAGE ⁽¹⁾		ORDERABLE PART NUMBER	TOP-SIDE MARKING
–40°C to 85°C	uQFN – RUG	Tape and Reel	TCA5405RUGR	6Y

(1) Package drawings, standard packing quantities, thermal data, symbolization, and PCB design guidelines are available at www.ti.com/sc/package.



Please be aware that an important notice concerning availability, standard warranty, and use in critical applications of Texas Instruments semiconductor products and disclaimers thereto appears at the end of this data sheet.



These devices have limited built-in ESD protection. The leads should be shorted together or the device placed in conductive foam during storage or handling to prevent electrostatic damage to the MOS gates.

APPLICATION DIAGRAM

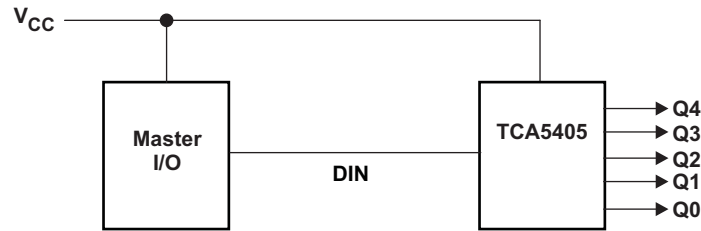

Figure 1. TCA5405 Application Diagram

ABSOLUTE MAXIMUM RATINGS⁽¹⁾

over operating free-air temperature range (unless otherwise noted)

			MIN	MAX	UNIT
V _{CC}	Supply voltage range		-0.5	4.0	V
V _I	Input voltage range ⁽²⁾		-0.5	4.0	V
V _O	Output voltage range ⁽²⁾		-0.5	4.0	V
I _{IK}	Input clamp current	V _I < 0		±20	mA
I _{OK}	Output clamp current	V _O < 0		±20	mA
I _{OL}	Continuous output low current	V _O = 0 to V _{CC}		50	mA
I _{OH}	Continuous output high current	V _O = 0 to V _{CC}		50	mA
I _{CC}	Continuous current through GND			200	mA
	Continuous current through V _{CC}			160	
θ _{JA}	Package thermal impedance ⁽³⁾	RUG package		243	°C/W
TSTG	Storage temperature range		-65	150	°C

- (1) Stresses above these ratings may cause permanent damage. Exposure to absolute maximum conditions for extended periods may degrade device reliability. These are stress ratings only, and functional operation of the device at these or any other conditions beyond those specified is not implied.
- (2) The input negative-voltage and output voltage ratings may be exceeded if the input and output current ratings are observed.
- (3) The package thermal impedance is calculated in accordance with JESD 51-7.

RECOMMENDED OPERATING CONDITIONS

			MIN	MAX	UNIT
V _{CC}	Supply voltage		1.65	3.6	V
V _{IH}	High-level input voltage	DIN	0.7 × V _{CC}	V _{CC} + 0.5	V
V _{IL}	Low-level input voltage	DIN	-0.3	0.3 × V _{CC}	V
I _{OH}	High-level output current	Q0–Q4		20	mA
I _{OL}	Low-level output current	Q0–Q4		20	mA
T _A	Operating free-air temperature		-40	85	°C

ELECTRICAL CHARACTERISTICS

 over recommended operating free-air temperature range, $V_{CC} = 1.65\text{ V to }3.6\text{ V}$ (unless otherwise noted)

PARAMETER		TEST CONDITIONS	V_{CC}	MIN	TYP	MAX	UNIT
V_{IK}	Input diode clamp voltage	$I_I = -18\text{ mA}$	1.65 V to 3.6 V	-1.2			V
V_{POR}	Power on reset voltage	$V_I = V_{CC}$ or GND, $I_O = 0$	1.65 V to 3.6 V		1	1.4	V
I_I	DIN	$V_I = V_{CC}$ or GND	1.65 V to 3.6 V			± 0.1	μA
I_{CC_STBY}	Standby Supply Current	V_I on DIN = V_{CC} or GND, $I_O = 0$	1.65 V to 3.6 V		1	2	μA
I_{CC_ACTIVE}	Active current during startup and data transfer					400	μA
C_I	DIN	$V_I = V_{CC}$ or GND	1.65 V to 3.6 V		6	7	pF
V_{OH}	OUT-port high-level output voltage	$I_{OH} = -20\text{ mA}$	1.65 V	1.1			V
			2.3 V	1.7			
			3.6 V	2.5			
V_{OL}	OUT-port low-level output voltage	$I_{OL} = 20\text{ mA}$	1.65 V			0.6	V
			2.3 V			0.3	
			3.6 V			0.25	

TIMING REQUIREMENTS

 over recommended operating free-air temperature range, $V_{CC} = 1.65\text{ V to }3.6\text{ V}$ (unless otherwise noted)

PARAMETER		TEST CONDITIONS	VCC	MIN	TYP	MAX	UNIT
t_{PER}	DIN period		1.65 V to 3.6 V	0.001		10	ms
t_{rise}	DIN rise time		1.65 V to 3.6 V			100	ns
t_{fall}	DIN fall time		1.65 V to 3.6 V			100	ns
f_{MIN}	Maximum switching frequency on DIN		1.65 V to 3.6 V	1			MHz
f_{MAX}	Minimum switching frequency on DIN		1.65 V to 3.6 V			10	kHz

PRINCIPLES OF OPERATION

The TCA5405 single-wire bus device has a single-bit Data Line Bus input and has five independent parallel push-pull buffered outputs. A single input is used to control the output state for the writing to these five outputs. This single-wire serial interface is similar to a UART type interface but operates over a wide range of values for the bit period.

The TCA5405 uses a self-timed serial data protocol with a single data input driven by a master device synchronized to an internal clock of that device. During a Setup phase, the bit period is sampled, then the TCA5405 generates its own internal clock synchronized to that of the Master device to sample the input over a five-bit-period Data Transfer phase and writes the bit states on the parallel outputs after the last bit is sampled. The Master output bit must be transmitted via a Totem-pole output structure to ensure proper interpretation of the incoming serial burst.

The single-wire unidirectional interface operation is defined in [Figure 2](#).

INTERFACE TIMING

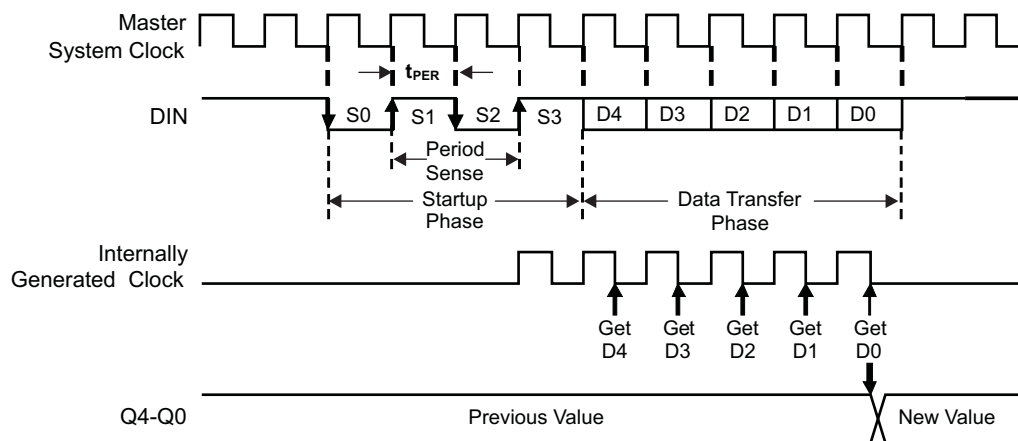

Figure 2. Definition of Single-Wire Interface

To function correctly, the bit period (t_{PER}) of the DIN signal must be constant over the entire data transaction. Therefore, DIN should be driven by a stable periodic signal internal to the Master device (see Figure 2 - Master System Clock). The bit period can be any value between $1\mu\text{S}$ and 10mS .

The TCA5405 first detects the falling transition on DIN at the beginning of the S_0 period to signal the start of an incoming data burst. Next, over the period of S_1/S_2 , between the two rising edges on DIN, a timer measures the duration of S_1/S_2 to calculate the bit period of the incoming signal. After that, the TCA5405 uses that value to generate its own internal clock which it uses to sample DIN as near as possible to the center of the subsequent D_4 - D_0 bit periods. After bit D_0 is sampled, the five sampled values are sent to the Q_4 - Q_0 outputs. At the end of the D_0 bit period, if DIN is not already high, it must be set high to signal the end of the transaction and to prepare for the next one.

TYPICAL CHARACTERISTICS

$T_A = 25^\circ\text{C}$ (unless otherwise noted)

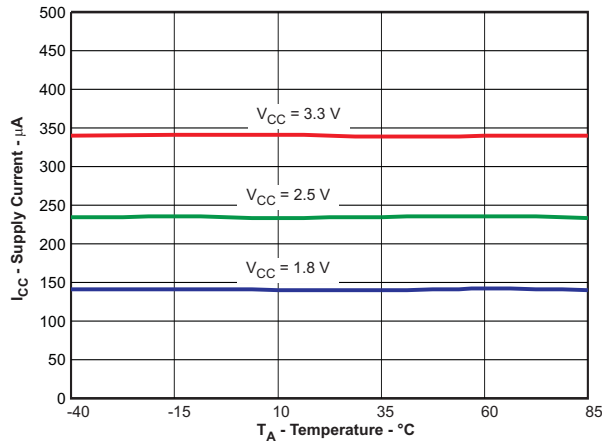

Figure 3. Active Current vs Temperature

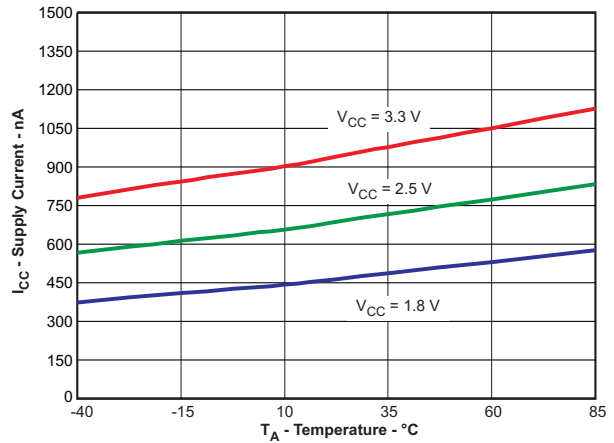

Figure 4. Standby Supply Current vs Temperature

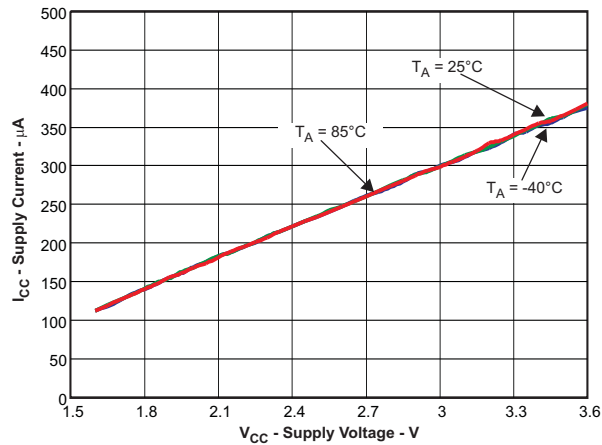

Figure 5. Active Supply Current vs Supply Voltage

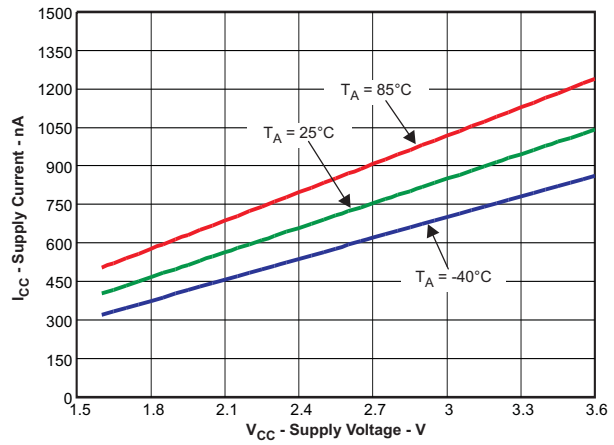

Figure 6. Standby Supply Current vs Supply Voltage

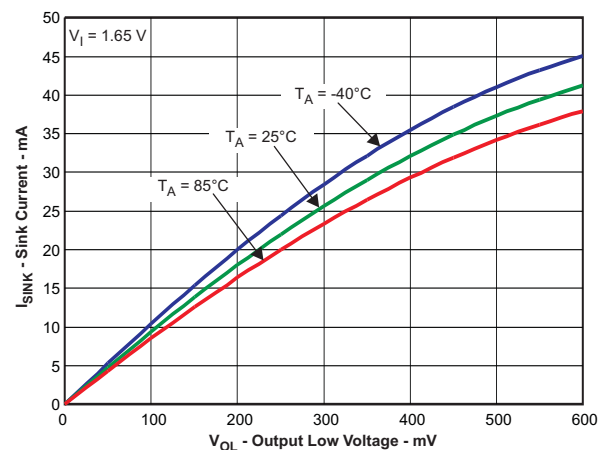

Figure 7. I/O Sink Current vs Output Low Voltage VCC = 1.65V

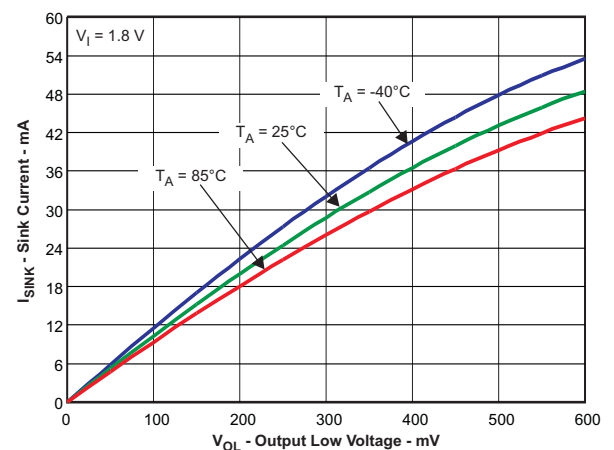

Figure 8. I/O Sink Current vs Output Low Voltage VCC = 1.8V

TYPICAL CHARACTERISTICS (continued)

$T_A = 25^\circ\text{C}$ (unless otherwise noted)

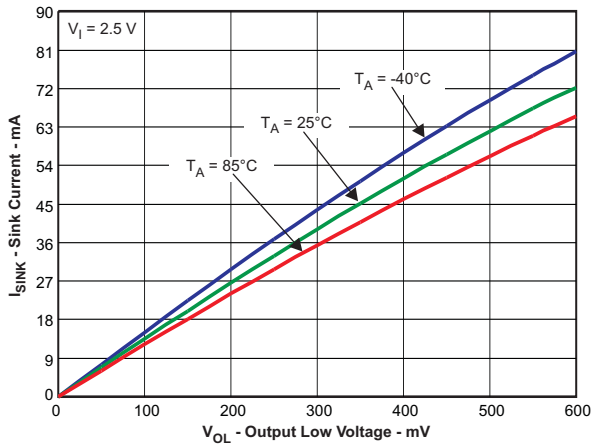

Figure 9. I/O Sink Current vs Output Low Voltage VCC = 2.5V

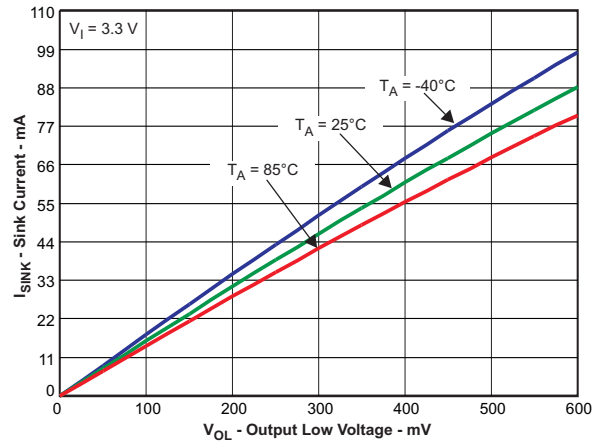

Figure 10. I/O Sink Current vs Output Low Voltage VCC = 3.3V

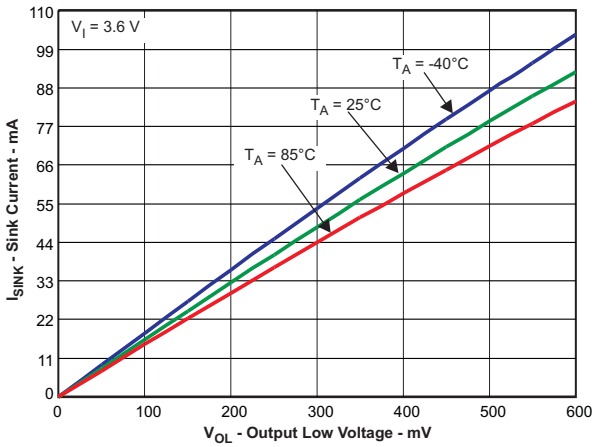

Figure 11. I/O Sink Current vs Output Low Voltage VCC = 3.6V

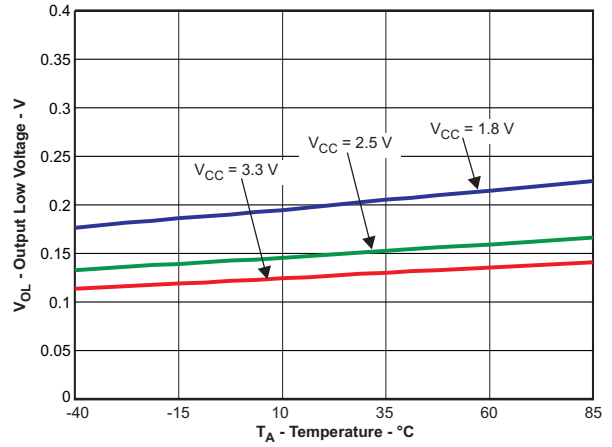

Figure 12. I/O Low Voltage vs Temperature VCC = 3.3V at 20 mA

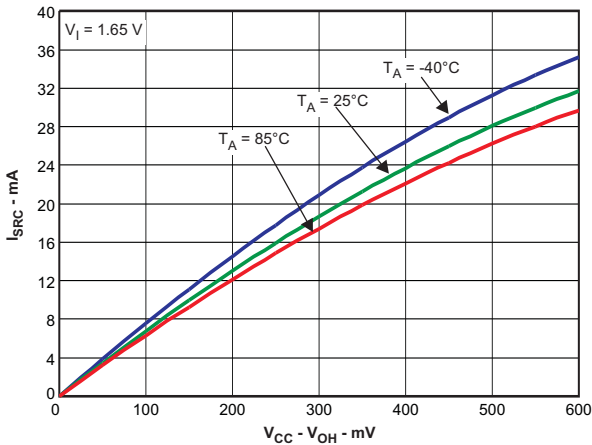

Figure 13. I/O Source Current vs Output High Voltage VCC = 1.65V

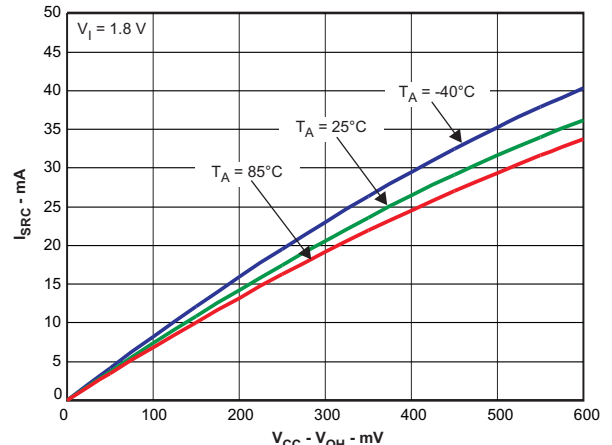

Figure 14. I/O Source Current vs Output High Voltage VCC = 1.8V

TYPICAL CHARACTERISTICS (continued)

T_A = 25°C (unless otherwise noted)

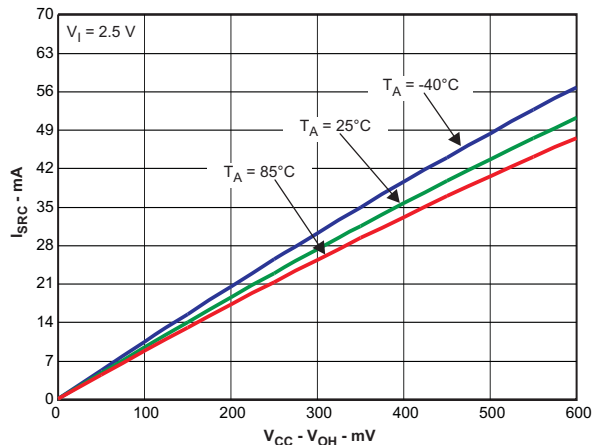

Figure 15. I/O Source Current vs Output High Voltage VCC = 2.5V

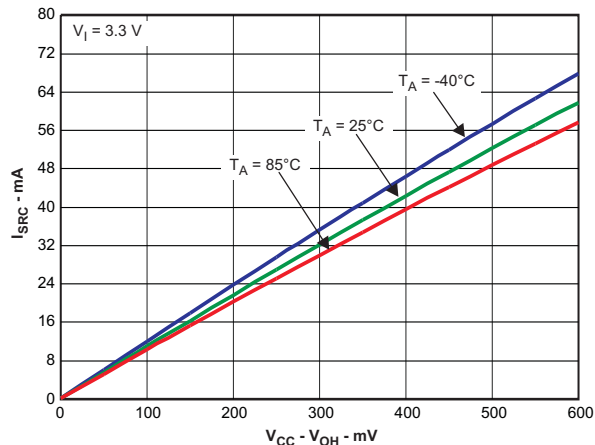

Figure 16. I/O Source Current vs Output High Voltage VCC = 3.3V

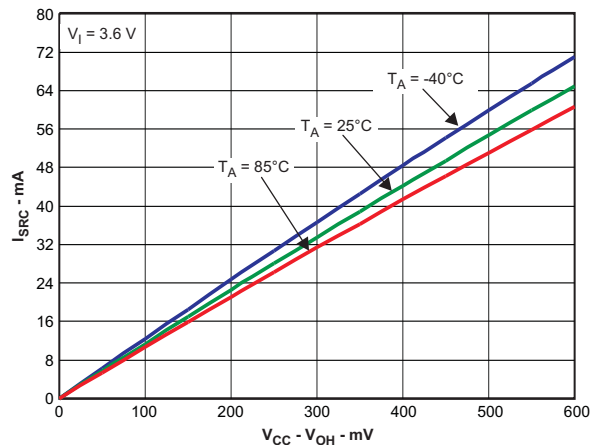

Figure 17. I/O Source Current vs Output High Voltage VCC = 3.6V

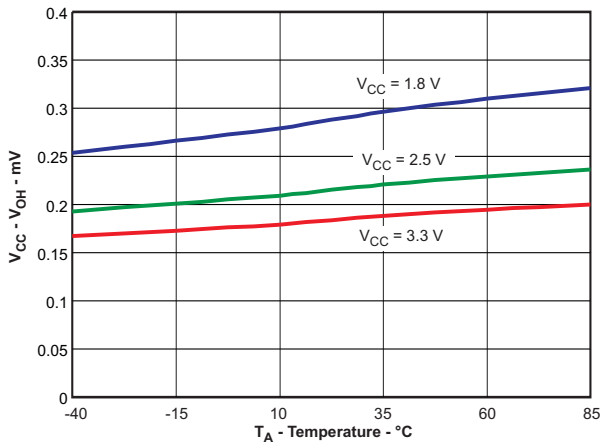

Figure 18. I/O High Voltage vs Temperature VCC = 3.3V at 20 mA

RUG0008A



PACKAGE OUTLINE

X2QFN - 0.4 mm max height

PLASTIC QUAD FLATPACK - NO LEAD

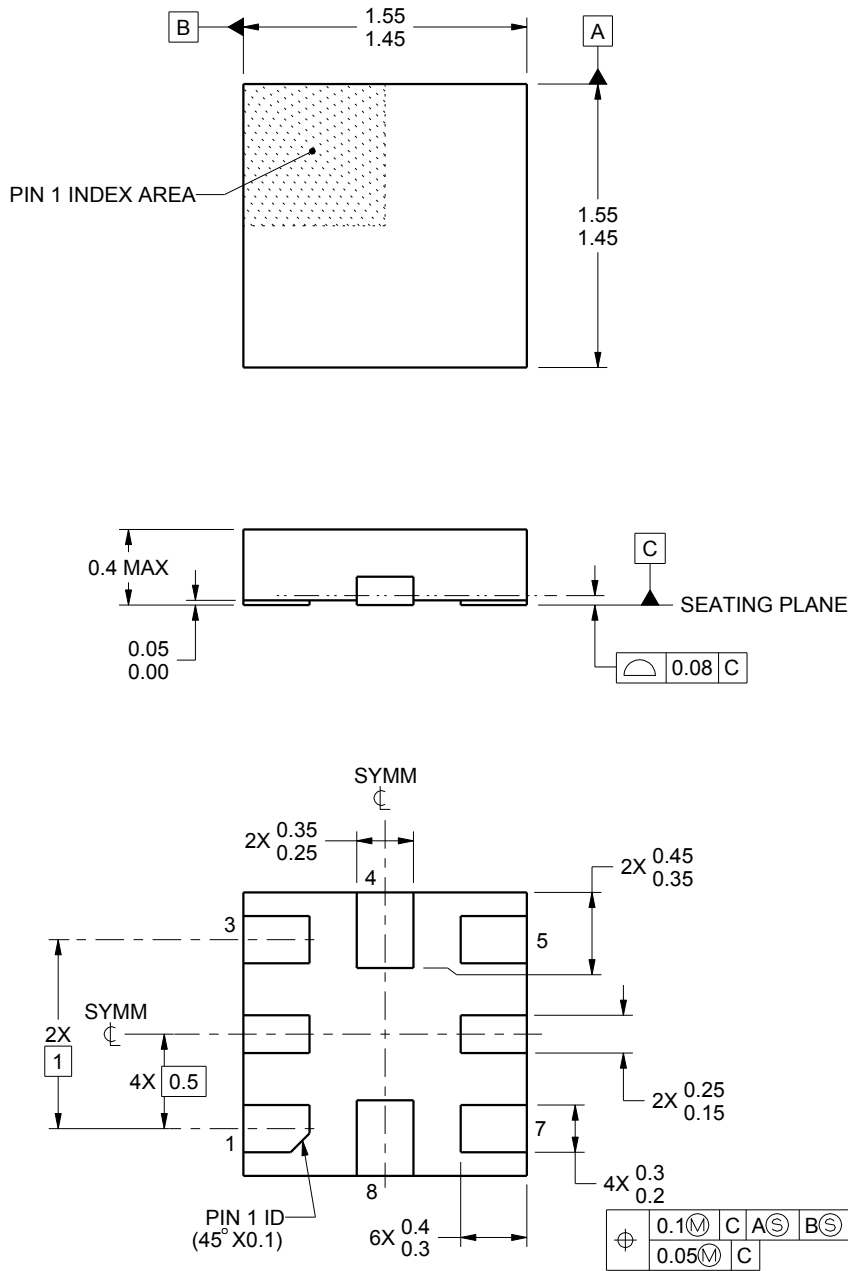

4222060/A 05/14/2015

NOTES:

1. All linear dimensions are in millimeters. Any dimensions in parenthesis are for reference only. Dimensioning and tolerancing per ASME Y14.5M.
2. This drawing is subject to change without notice.

EXAMPLE BOARD LAYOUT

RUG0008A

X2QFN - 0.4 mm max height

PLASTIC QUAD FLATPACK - NO LEAD

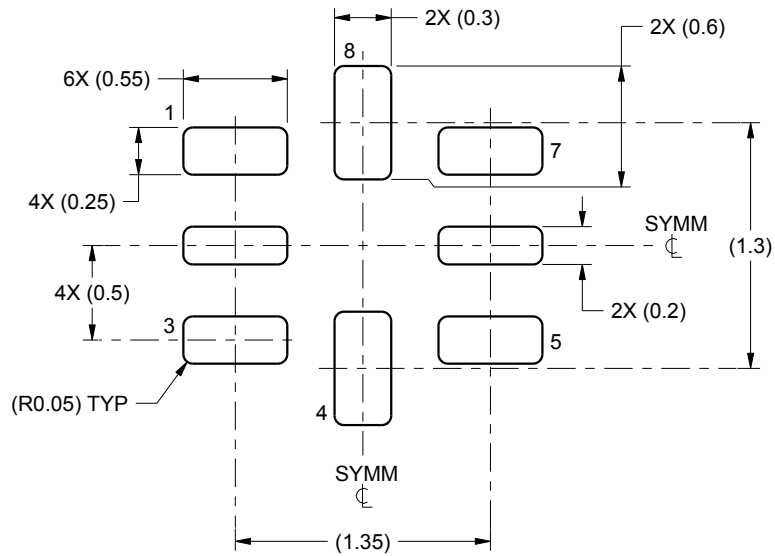

LAND PATTERN EXAMPLE
SCALE:25X

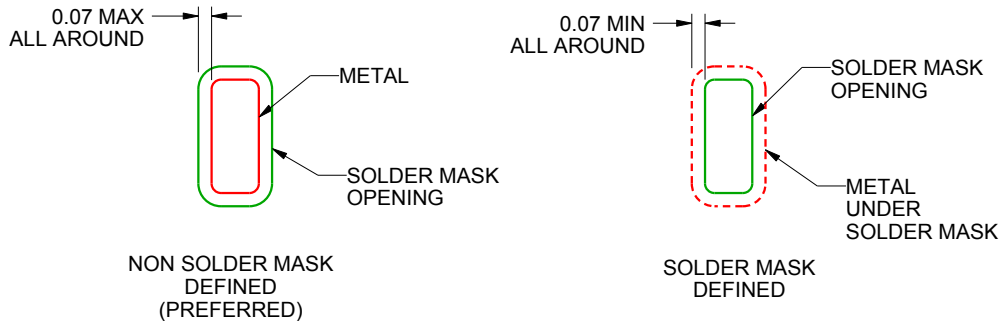

SOLDER MASK DETAILS
NOT TO SCALE

4222060/A 05/14/2015

NOTES: (continued)

3. For more information, see Texas Instruments literature number SLUA271 (www.ti.com/lit/slua271).

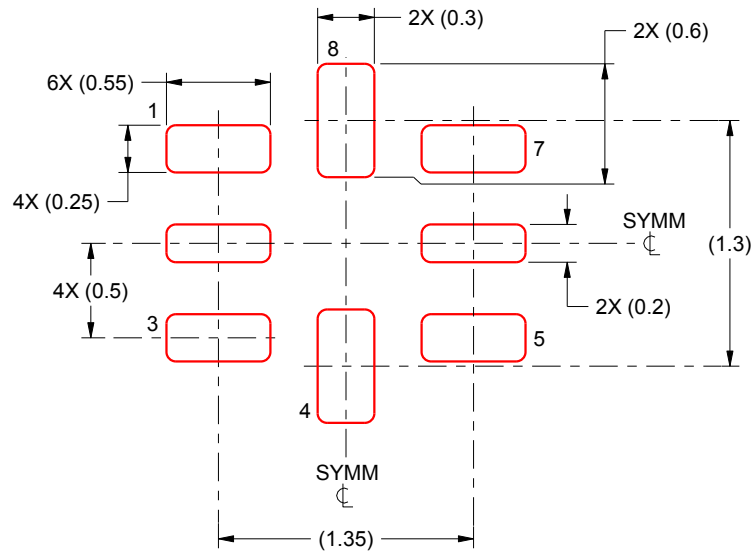

SOLDER PASTE EXAMPLE
BASED ON 0.1 mm THICKNESS
SCALE:25X

NOTES: (continued)

4. Laser cutting apertures with trapezoidal walls and rounded corners may offer better paste release. IPC-7525 may have alternate design recommendations.

PACKAGING INFORMATION

Orderable part number	Status (1)	Material type (2)	Package Pins	Package qty Carrier	RoHS (3)	Lead finish/ Ball material (4)	MSL rating/ Peak reflow (5)	Op temp (°C)	Part marking (6)
TCA5405RUGR	Active	Production	X2QFN (RUG) 8	3000 LARGE T&R	Yes	NIPDAUAG	Level-1-260C-UNLIM	-40 to 85	6Y
TCA5405RUGR.B	Active	Production	X2QFN (RUG) 8	3000 LARGE T&R	Yes	NIPDAUAG	Level-1-260C-UNLIM	-40 to 85	6Y

(1) **Status:** For more details on status, see our [product life cycle](#).

(2) **Material type:** When designated, preproduction parts are prototypes/experimental devices, and are not yet approved or released for full production. Testing and final process, including without limitation quality assurance, reliability performance testing, and/or process qualification, may not yet be complete, and this item is subject to further changes or possible discontinuation. If available for ordering, purchases will be subject to an additional waiver at checkout, and are intended for early internal evaluation purposes only. These items are sold without warranties of any kind.

(3) **RoHS values:** Yes, No, RoHS Exempt. See the [TI RoHS Statement](#) for additional information and value definition.

(4) **Lead finish/Ball material:** Parts may have multiple material finish options. Finish options are separated by a vertical ruled line. Lead finish/Ball material values may wrap to two lines if the finish value exceeds the maximum column width.

(5) **MSL rating/Peak reflow:** The moisture sensitivity level ratings and peak solder (reflow) temperatures. In the event that a part has multiple moisture sensitivity ratings, only the lowest level per JEDEC standards is shown. Refer to the shipping label for the actual reflow temperature that will be used to mount the part to the printed circuit board.

(6) **Part marking:** There may be an additional marking, which relates to the logo, the lot trace code information, or the environmental category of the part.

Multiple part markings will be inside parentheses. Only one part marking contained in parentheses and separated by a "~" will appear on a part. If a line is indented then it is a continuation of the previous line and the two combined represent the entire part marking for that device.

Important Information and Disclaimer: The information provided on this page represents TI's knowledge and belief as of the date that it is provided. TI bases its knowledge and belief on information provided by third parties, and makes no representation or warranty as to the accuracy of such information. Efforts are underway to better integrate information from third parties. TI has taken and continues to take reasonable steps to provide representative and accurate information but may not have conducted destructive testing or chemical analysis on incoming materials and chemicals. TI and TI suppliers consider certain information to be proprietary, and thus CAS numbers and other limited information may not be available for release.

In no event shall TI's liability arising out of such information exceed the total purchase price of the TI part(s) at issue in this document sold by TI to Customer on an annual basis.

TAPE AND REEL INFORMATION



QUADRANT ASSIGNMENTS FOR PIN 1 ORIENTATION IN TAPE



*All dimensions are nominal

Device	Package Type	Package Drawing	Pins	SPQ	Reel Diameter (mm)	Reel Width W1 (mm)	A0 (mm)	B0 (mm)	K0 (mm)	P1 (mm)	W (mm)	Pin1 Quadrant
TCA5405RUGR	X2QFN	RUG	8	3000	180.0	8.4	1.7	1.7	0.7	4.0	8.0	Q2

TAPE AND REEL BOX DIMENSIONS



*All dimensions are nominal

Device	Package Type	Package Drawing	Pins	SPQ	Length (mm)	Width (mm)	Height (mm)
TCA5405RUGR	X2QFN	RUG	8	3000	202.0	201.0	28.0

IMPORTANT NOTICE AND DISCLAIMER

TI PROVIDES TECHNICAL AND RELIABILITY DATA (INCLUDING DATA SHEETS), DESIGN RESOURCES (INCLUDING REFERENCE DESIGNS), APPLICATION OR OTHER DESIGN ADVICE, WEB TOOLS, SAFETY INFORMATION, AND OTHER RESOURCES "AS IS" AND WITH ALL FAULTS, AND DISCLAIMS ALL WARRANTIES, EXPRESS AND IMPLIED, INCLUDING WITHOUT LIMITATION ANY IMPLIED WARRANTIES OF MERCHANTABILITY, FITNESS FOR A PARTICULAR PURPOSE OR NON-INFRINGEMENT OF THIRD PARTY INTELLECTUAL PROPERTY RIGHTS.

These resources are intended for skilled developers designing with TI products. You are solely responsible for (1) selecting the appropriate TI products for your application, (2) designing, validating and testing your application, and (3) ensuring your application meets applicable standards, and any other safety, security, regulatory or other requirements.

These resources are subject to change without notice. TI grants you permission to use these resources only for development of an application that uses the TI products described in the resource. Other reproduction and display of these resources is prohibited. No license is granted to any other TI intellectual property right or to any third party intellectual property right. TI disclaims responsibility for, and you will fully indemnify TI and its representatives against, any claims, damages, costs, losses, and liabilities arising out of your use of these resources.

TI's products are provided subject to [TI's Terms of Sale](#) or other applicable terms available either on [ti.com](https://www.ti.com) or provided in conjunction with such TI products. TI's provision of these resources does not expand or otherwise alter TI's applicable warranties or warranty disclaimers for TI products.

TI objects to and rejects any additional or different terms you may have proposed.

Mailing Address: Texas Instruments, Post Office Box 655303, Dallas, Texas 75265

Copyright © 2025, Texas Instruments Incorporated