

TPS7A470x 36V, 1A, 4 μ V_{RMS}, 射频 (RF) 低压降 (LDO) 电压稳压器

1 特性

- 输入电压范围: +3V 至 +36V
- 输出电压噪声:
4 μ V_{RMS}(10Hz, 100Hz)
- 电源纹波抑制:
 - 82dB (100Hz)
 - \geq 55dB (10Hz, 10MHz)
- 两个输出电压模式:
 - ANY-OUT™ 版本 (借助印刷电路板 (PCB) 布局布线的用户可调输出):
 - 无需外部反馈电阻器或者前馈电容器
 - 输出电压范围: +1.4V 至 +20.5V
 - 可调版本 (仅适用于 TPS7A4701):
 - 输出电压范围: +1.4V 至 +34V
- 输出电流: 1A
- 压降电压: 1A 时为 307mV
- 与 CMOS 逻辑电平兼容的启用引脚
- 内置固定电流限制和热关断
- 采用高性能散热封装: 5mm x 5mm 四方扁平无引线 (QFN)
- 工作温度范围:
–40°C 至 125°C

2 应用

- 压控振荡器 (VCO)
- 频率合成器
- 测试和测量
- 仪器仪表、医疗和音频
- RX, TX, 和 PA 电路
- 用于运算放大器, 数模转换器 (DAC), 模数转换器 (ADC), 和其它高精度模拟电路的电源轨
- 后置 DC/DC 转换器稳压和纹波滤除
- 基站和电信基础设施
- +12V 和 +24V 工业用总线

3 说明

TPS7A47 是一款正电压 (+36V) 超低噪声 (4 μ V_{RMS}) 低压降线性稳压器 (LDO) 系列产品, 能够提供 1A 负载。

用户可通过印刷电路板 (PCB) 布局布线来编程设定 TPS7A4700 输出电压 (最高 20.5V), 无需外部电阻器或前馈电容器, 从而减少了元件总数量。

配置 TPS7A4701 输出电压时, 用户可通过 PCB 布局编程设定 (高达 20.5V) 或使用外部反馈电阻器调节 (高达 34V)。

TPS7A47 由双极型技术设计而成, 主要用于高精度、高精度仪器仪表应用。在此类应用中, 规整的电压轨对于系统性能的最大化至关重要。这种设计使其成为功率运算放大器, 模数转换器 (ADC), 数模转换器 (DAC) 及其它关键应用 (诸如医疗、射频 (RF) 和测试测量应用) 中高性能模拟电路的最佳选择。

此外, TPS7A47 线性稳压器也非常适合于后置 DC/DC 转换器稳压。通过滤除 dc/dc 开关转换所固有的输出电压纹波, 可确保在灵敏仪器仪表、测试和测量、音频和 RF 应用中将系统性能最大化。

对于需要正向和负向低噪声电源轨的应用, 请考虑 TI 的 TPS7A33 负向高电压、超低噪声线性稳压器系列产品。

器件信息(1)

| 部件号 | 封装 | 封装尺寸 (标称值) |
|-----------|-----------|------------|
| TPS7A470x | VQFN (20) | 5mm x 5mm |

(1) 如需了解所有可用封装, 请见数据表末尾的可订购产品附录。

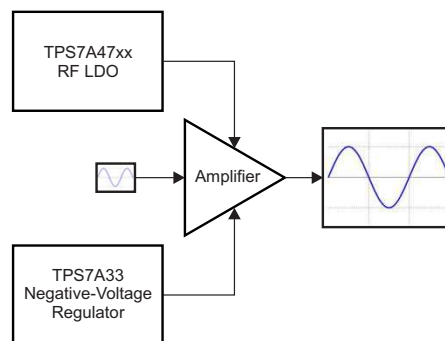

目录

| | | | | | |
|-----|---------------------------------------|----|------|--|----|
| 1 | 特性 | 1 | 8 | Application and Implementation | 16 |
| 2 | 应用 | 1 | 8.1 | Application Information..... | 16 |
| 3 | 说明 | 1 | 8.2 | Typical Application | 16 |
| 4 | 修订历史记录 | 2 | 9 | Power Supply Recommendations | 20 |
| 5 | Pin Configuration and Functions | 4 | 9.1 | Power Dissipation (P _D)..... | 20 |
| 6 | Specifications..... | 5 | 10 | Layout..... | 21 |
| 6.1 | Absolute Maximum Ratings | 5 | 10.1 | Layout Guidelines | 21 |
| 6.2 | Handling Ratings..... | 6 | 10.2 | Layout Example | 21 |
| 6.3 | Recommended Operating Conditions..... | 6 | 10.3 | Thermal Protection..... | 22 |
| 6.4 | Thermal Information | 6 | 10.4 | Estimating Junction Temperature | 22 |
| 6.5 | Electrical Characteristics..... | 7 | 11 | 器件和文档支持 | 23 |
| 6.6 | Typical Characteristics..... | 8 | 11.1 | 文档支持..... | 23 |
| 7 | Detailed Description | 12 | 11.2 | 相关链接..... | 23 |
| 7.1 | Overview | 12 | 11.3 | 商标..... | 23 |
| 7.2 | Functional Block Diagram | 12 | 11.4 | 静电放电警告..... | 23 |
| 7.3 | Feature Description..... | 12 | 11.5 | 术语表 | 23 |
| 7.4 | Device Functional Modes..... | 13 | 12 | 机械封装和可订购信息 | 23 |
| 7.5 | Programming..... | 13 | | | |

4 修订历史记录

NOTE: Page numbers for previous revisions may differ from page numbers in the current version.

| Changes from Revision E (January 2014) to Revision F | Page |
|--|------|
| • 已添加 处理额定值表、特性描述部分、器件功能模式、应用和实施部分、电源相关建议部分、布局部分、器件和文档支持部分以及机械、封装和可订购信息部分 | 1 |
| • 重新编写了特性列表中的第九个要点 | 1 |
| • Changed polarity of op amp shown on right side of the functional block diagram | 12 |
| • Reworded second paragraph in <i>Soft-Start And Inrush Current</i> section | 13 |
| • Revised <i>Capacitor Recommendations</i> section..... | 16 |
| • Changed paragraph 2 of <i>Dropout Voltage (V_{DO})</i> section for clarity | 17 |
| • Revised paragraph 1 of <i>Startup</i> section | 17 |
| • Rewrote paragraph 1 of <i>Power-Supply Rejection Ratio (PSRR)</i> section to eliminate confusion | 18 |
| • Changed paragraph 1 of <i>Power Supply Recommendations</i> section | 20 |
| • Changed paragraph 1 and paragraph 4 of <i>Power Dissipation (P_D)</i> section..... | 20 |
| • Revised paragraph 2 of <i>Layout Guidelines</i> section | 21 |
| • Changed second paragraph of <i>Thermal Protection</i> section | 22 |

| Changes from Revision D (December 2013) to Revision E | Page |
|---|------|
| • 标题页的三个实例中输出电压噪声值从 4.17μV 改为 4μV | 1 |
| • 更改了说明部分中的第二段和第三段 | 1 |
| • Added "Thermal Pad" to pin configuration drawing..... | 4 |
| • Changed EN pin description..... | 4 |
| • Changed SENSE/FB pin to be for TPS7A4701 only..... | 5 |
| • Added new row to Pin Descriptions table for SENSE pin (for TPS7A4700 only)..... | 5 |
| • Added new row to Pin Descriptions table for thermal pad | 5 |
| • Added V _{REF} parameter..... | 7 |
| • Added TPS7A4701 device to test conditions for V _{NR} parameter..... | 7 |

| | |
|--|----|
| • Added Feedback Pin Current parameter to Electrical Characteristics | 7 |
| • Deleted Dropout Voltage vs Output Current graph | 8 |
| • Added EN pin to Functional Block Diagram | 12 |
| • Added sentence to ANY-OUT Programmable Output Voltage section to clarify ANY-OUT is for both devices | 13 |
| • Changed last two paragraphs of <i>Adjustable Operation</i> section | 14 |
| • Added "TPS7A4701 Only" to <i>Adjustable Operation</i> section title | 14 |
| • Deleted equation in Figure 23 | 14 |
| • Changed Equation 3 | 14 |

Changes from Revision C (July 2013) to Revision D
Page

| | |
|---|----|
| • 将数据表状态从生产结构更改为生产数据 | 1 |
| • 已将 TPS7A4701 静电放电 (ESD) 额定值从 > 1kV 更改为 2.5kV | 1 |
| • Changed noise reduction pin voltage parameter to show both devices | 7 |
| • Added text clarifying V_{REF} typical value to last paragraph on page | 14 |

Changes from Revision B (April 2013) to Revision C
Page

| | |
|---------------------------------|---|
| • 从数据表中删除了 TPS7A4702 预览器件 | 1 |
|---------------------------------|---|

Changes from Revision A (July 2012) to Revision B
Page

| | |
|---|----|
| • 已将 TPS7A47 改为 TPS7A4700 | 1 |
| • 已将 TPS7A4701 和 TPS7A4702 预览器件添加到数据表中 | 1 |
| • 更改了标题页图表 | 1 |
| • Added FB to SENSE pin to Functional Block Diagram | 12 |
| • Added new paragraph after Table 1 | 14 |
| • Added new Table 2 | 14 |
| • Added <i>Adjustable Operation</i> section | 14 |

Changes from Original (June 2012) to Revision A
Page

| | |
|-------------------------------|---|
| • 已移动到全生产数据（在整个文档中进行更改） | 1 |
|-------------------------------|---|

5 Pin Configuration and Functions

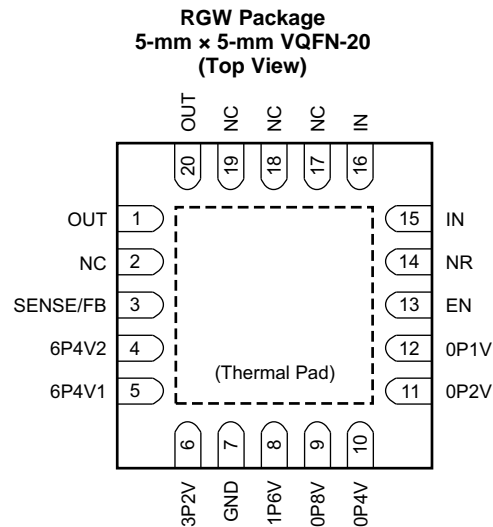

Pin Functions

| PIN | | I/O | DESCRIPTION |
|-------|----------|-----|--|
| NAME | NO. | | |
| 0P1V | 12 | I | When connected to GND, this pin adds 0.1 V to the nominal output voltage of the regulator. Do not connect any voltage other than GND to this pin. If not used, leave this pin floating. |
| 0P2V | 11 | I | When connected to GND, this pin adds 0.2 V to the nominal output voltage of the regulator. Do not connect any voltage other than GND to this pin. If not used, leave this pin floating. |
| 0P4V | 10 | I | When connected to GND, this pin adds 0.4 V to the nominal output voltage of the regulator. Do not connect any voltage other than GND to this pin. If not used, leave this pin floating. |
| 0P8V | 9 | I | When connected to GND, this pin adds 0.8 V to the nominal output voltage of the regulator. Do not connect any voltage other than GND to this pin. If not used, leave this pin floating. |
| 1P6V | 8 | I | When connected to GND, this pin adds 1.6 V to the nominal output voltage of the regulator. Do not connect any voltage other than GND to this pin. If not used, leave this pin floating. |
| 3P2V | 6 | I | When connected to GND, this pin adds 3.2 V to the nominal output voltage of the regulator. Do not connect any voltage other than GND to this pin. If not used, leave this pin floating. |
| 6P4V1 | 5 | I | When connected to GND, this pin adds 6.4 V to the nominal output voltage of the regulator. Do not connect any voltage other than GND to this pin. If not used, leave this pin floating. |
| 6P4V2 | 4 | I | When connected to GND, this pin adds 6.4 V to the nominal output voltage of the regulator. Do not connect any voltage other than GND to this pin. If not used, leave this pin floating. |
| EN | 13 | I | Enable pin. The device is enabled when the voltage on this pin exceeds the maximum enable voltage, $V_{EN(HI)}$. If enable is not required, tie EN to IN. |
| GND | 7 | — | Ground |
| IN | 15, 16 | I | Input supply. A capacitor greater than or equal to 1 μ F must be tied from this pin to ground to assure stability. A 10- μ F capacitor is recommended to be connected from IN to GND (as close to the device as possible) to reduce circuit sensitivity to printed circuit board (PCB) layout, especially when long input traces or high source impedances are encountered. |
| NC | 2, 17-19 | — | This pin can be left open or tied to any voltage between GND and IN. |
| NR | 14 | — | Noise reduction pin. When a capacitor is connected from this pin to GND, RMS noise can be reduced to very low levels. A capacitor greater than or equal to 10 nF must be tied from this pin to ground to assure stability. A 1- μ F capacitor is recommended to be connected from NR to GND (as close to the device as possible) to maximize ac performance and minimize noise. |

Pin Functions (continued)

| PIN | | I/O | DESCRIPTION |
|-------------|-------|-----|--|
| NAME | NO. | | |
| OUT | 1, 20 | O | Regulator output. A capacitor greater than or equal to 10 μ F must be tied from this pin to ground to assure stability. A 47- μ F ceramic output capacitor is highly recommended to be connected from OUT to GND (as close to the device as possible) to maximize ac performance. |
| SENSE/FB | 3 | I | Control-loop error amplifier input (TPS7A4701 only). This is the SENSE pin if the device output voltage is programmed using ANY-OUT (no external feedback resistors). This pin must be connected to OUT. Connect this pin to the point of load to maximize accuracy. This is the FB pin if the device output voltage is set using external resistors. See the Adjustable Operation section for more details. |
| SENSE | 3 | I | Control-loop error amplifier input (TPS7A4700 only). This is the SENSE pin of the device and must be connected to OUT. Connect this pin to the point of load to maximize accuracy. |
| Thermal Pad | | — | Connect the thermal pad to a large-area ground plane. The thermal pad is internally connected to GND. |

6 Specifications

6.1 Absolute Maximum Ratings

Over junction temperature range, unless otherwise noted.⁽¹⁾

| | | MIN | MAX | UNIT |
|------------------------|--|--------------------|------|------|
| Voltage ⁽²⁾ | IN pin to GND pin | −0.4 | +36 | V |
| | EN pin to GND pin | −0.4 | +36 | V |
| | EN pin to IN pin | −36 | +0.4 | V |
| | OUT pin to GND pin | −0.4 | +36 | V |
| | NR pin to GND pin | −0.4 | +36 | V |
| | SENSE/FB pin to GND pin | −0.4 | +36 | V |
| | 0P1V pin to GND pin | −0.4 | +36 | V |
| | 0P2V pin to GND pin | −0.4 | +36 | V |
| | 0P4V pin to GND pin | −0.4 | +36 | V |
| | 0P8V pin to GND pin | −0.4 | +36 | V |
| | 1P6V pin to GND pin | −0.4 | +36 | V |
| | 3P2V pin to GND pin | −0.4 | +36 | V |
| | 6P4V1 pin to GND pin | −0.4 | +36 | V |
| | 6P4V2 pin to GND pin | −0.4 | +36 | V |
| Current | Peak output | Internally limited | | |
| Temperature | Operating virtual junction, T _J | −40 | 125 | °C |

(1) Stresses beyond those listed under *Absolute Maximum Ratings* may cause permanent damage to the device. These are stress ratings only, which do not imply functional operation of the device at these or any other conditions beyond those indicated under *Recommended Operating Conditions*. Exposure to absolute-maximum-rated conditions for extended periods may affect device reliability..

(2) All voltages are with respect to network ground terminal.

6.2 Handling Ratings

| | | MIN | MAX | UNIT | | |
|-------------|---------------------------|-----------|--|-------|------|---|
| T_{stg} | Storage temperature range | -65 | 150 | °C | | |
| $V_{(ESD)}$ | Electrostatic discharge | TPS7A4700 | Human body model (HBM), per ANSI/ESDA/JEDEC JS-001, all pins ⁽¹⁾ | -1000 | 1000 | V |
| | | | Charged device model (CDM), per JEDEC specification JESD22-C101, all pins ⁽²⁾ | -500 | 500 | |
| | | TPS7A4701 | Human body model (HBM), per ANSI/ESDA/JEDEC JS-001, all pins ⁽¹⁾ | -2500 | 2500 | V |
| | | | Charged device model (CDM), per JEDEC specification JESD22-C101, all pins ⁽²⁾ | -500 | 500 | |

(1) JEDEC document JEP155 states that 500-V HBM allows safe manufacturing with a standard ESD control process.

(2) JEDEC document JEP157 states that 250-V CDM allows safe manufacturing with a standard ESD control process.

6.3 Recommended Operating Conditions

over junction temperature range (unless otherwise noted)

| | MIN | NOM | MAX | UNIT |
|----------|-----|-----|----------|------|
| V_I | 3.0 | | 35.0 | V |
| V_O | 1.4 | | 34.0 | V |
| V_{EN} | 0 | | V_{IN} | V |
| I_O | 0 | | 1.0 | A |

6.4 Thermal Information

| THERMAL METRIC ⁽¹⁾ | | TPS7A47xx | UNIT |
|-------------------------------|--|-----------|------|
| | | RGW | |
| | | 20 PINS | |
| $R_{\theta JA}$ | Junction-to-ambient thermal resistance | 32.5 | °C/W |
| $R_{\theta JC(top)}$ | Junction-to-case (top) thermal resistance | 27 | |
| $R_{\theta JB}$ | Junction-to-board thermal resistance | 11.9 | |
| Ψ_{JT} | Junction-to-top characterization parameter | 0.3 | |
| Ψ_{JB} | Junction-to-board characterization parameter | 11.9 | |
| $R_{\theta JC(bot)}$ | Junction-to-case (bottom) thermal resistance | 1.7 | |

(1) For more information about traditional and new thermal metrics, see the *IC Package Thermal Metrics* application report, [SPRA953](#).

6.5 Electrical Characteristics

At $-40^{\circ}\text{C} \leq T_J \leq 125^{\circ}\text{C}$; $V_I = V_{O(\text{nom})} + 1.0\text{ V}$ or $V_I = 3.0\text{ V}$ (whichever is greater); $V_{\text{EN}} = V_I$; $I_O = 0\text{ mA}$; $C_{\text{IN}} = 10\text{ }\mu\text{F}$; $C_{\text{OUT}} = 10\text{ }\mu\text{F}$; $C_{\text{NR}} = 10\text{ nF}$; SENSE/FB tied to OUT; and 0P1V, 0P2V, 0P4V, 0P8V, 1P6V, 3P2V, 6P4V1, 6P4V2 pins OPEN, unless otherwise noted.

| PARAMETER | | TEST CONDITIONS | | MIN | TYP | MAX | UNIT |
|-------------------------------|----------------------------------|--|---|------|------------------|-------|----------------------------|
| V_I | Input voltage range | | | 3 | | 35 | V |
| V_{UVLO} | Under-voltage lockout threshold | V_I rising | | | 2.67 | | V |
| | | V_I falling | | | 2.5 | | V |
| $V_{(\text{REF})}$ | Reference voltage | $V_{(\text{REF})} = V_{(\text{FB})}$, TPS7A4701 only | | | 1.4 | | V |
| $V_{\text{UVLO}(\text{HYS})}$ | Under-voltage lockout hysteresis | | | | 177 | | mV |
| V_{NR} | Noise reduction pin voltage | TPS7A4700, TPS7A4701 using ANY-OUT option | | | V_{OUT} | | V |
| | | TPS7A4701 in adjustable mode only | | | 1.4 | | V |
| V_O | Output voltage range | $V_I \geq V_{O(\text{nom})} + 1.0\text{ V}$ or 3 V (whichever is greater), $C_{\text{OUT}} = 20\text{ }\mu\text{F}$ | TPS7A4700, TPS7A4701 using ANY-OUT option | 1.4 | | 20.5 | V |
| | | | TPS7A4701 using adjustable option | 1.4 | | 34 | V |
| | Nominal accuracy | $T_J = 25^{\circ}\text{C}$, $C_{\text{OUT}} = 20\text{ }\mu\text{F}$ | | -1.0 | | 1.0 | % V_O |
| | Overall accuracy | $V_{O(\text{nom})} + 1.0\text{ V} \leq V_I \leq 35\text{ V}$, $0\text{ mA} \leq I_O \leq 1\text{ A}$, $C_{\text{OUT}} = 20\text{ }\mu\text{F}$ | | -2.5 | | 2.5 | % V_O |
| $\Delta V_{O(\Delta V_I)}$ | Line regulation | $V_{O(\text{nom})} + 1.0\text{ V} \leq V_I \leq 35\text{ V}$ | | | 0.092 | | % V_O |
| $\Delta V_{O(\Delta I_O)}$ | Load regulation | $0\text{ mA} \leq I_O \leq 1\text{ A}$ | | | 0.3 | | % V_O |
| $V_{(\text{DO})}$ | Dropout voltage | $V_I = 95\% V_{O(\text{nom})}$, $I_O = 0.5\text{ A}$ | | | 216 | | mV |
| | | $V_I = 95\% V_{O(\text{nom})}$, $I_O = 1\text{ A}$ | | | 307 | 450 | mV |
| $I_{(\text{CL})}$ | Current limit | $V_O = 90\% V_{O(\text{nom})}$ | | 1 | 1.26 | | A |
| $I_{(\text{GND})}$ | Ground pin current | $I_O = 0\text{ mA}$ | | | 0.58 | 1.0 | mA |
| | | $I_O = 1\text{ A}$ | | | 6.1 | | mA |
| $I_{(\text{EN})}$ | Enable pin current | $V_{\text{EN}} = V_I$ | | | 0.78 | 2 | μA |
| | | $V_I = V_{\text{EN}} = 35\text{ V}$ | | | 0.81 | 2 | μA |
| $I_{(\text{SHDN})}$ | Shutdown supply current | $V_{\text{EN}} = 0.4\text{ V}$ | | | 2.55 | 8 | μA |
| | | $V_{\text{EN}} = 0.4\text{ V}$, $V_I = 35\text{ V}$ | | | 3.04 | 60 | μA |
| $V_{+\text{EN}(\text{HI})}$ | Enable high-level voltage | | | 2.0 | | V_I | V |
| $V_{+\text{EN}(\text{LO})}$ | Enable low-level voltage | | | 0.0 | | 0.4 | V |
| $I_{(\text{FB})}$ | Feedback pin current | | | | 350 | | nA |
| PSRR | Power-supply rejection ratio | $V_I = 16\text{ V}$, $V_{O(\text{nom})} = 15\text{ V}$, $C_{\text{OUT}} = 50\text{ }\mu\text{F}$, $I_O = 500\text{ mA}$, $C_{\text{NR}} = 1\text{ }\mu\text{F}$, $f = 1\text{ kHz}$ | | | 78 | | dB |
| V_n | Output noise voltage | $V_I = 3\text{ V}$, $V_{O(\text{nom})} = 1.4\text{ V}$, $C_{\text{OUT}} = 50\text{ }\mu\text{F}$, $C_{\text{NR}} = 1\text{ }\mu\text{F}$, $\text{BW} = 10\text{ Hz to }100\text{ kHz}$ | | | 4.17 | | μV_{RMS} |
| | | $V_{\text{IN}} = 6\text{ V}$, $V_{O(\text{nom})} = 5\text{ V}$, $C_{\text{OUT}} = 50\text{ }\mu\text{F}$, $C_{\text{NR}} = 1\text{ }\mu\text{F}$, $\text{BW} = 10\text{ Hz to }100\text{ kHz}$ | | | 4.67 | | μV_{RMS} |
| T_{sd} | Thermal shutdown temperature | Shutdown, temperature increasing | | | 170 | | $^{\circ}\text{C}$ |
| | | Reset, temperature decreasing | | | 150 | | $^{\circ}\text{C}$ |
| T_J | Operating junction temperature | | | -40 | | 125 | $^{\circ}\text{C}$ |

6.6 Typical Characteristics

At $-40^{\circ}\text{C} \leq T_J \leq 125^{\circ}\text{C}$; $V_I = V_{O(\text{nom})} + 1.0\text{ V}$ or $V_I = 3.0\text{ V}$ (whichever is greater); $V_{\text{EN}} = V_I$; $I_O = 0\text{ mA}$; $C_{\text{IN}} = 10\text{ }\mu\text{F}$; $C_{\text{OUT}} = 10\text{ }\mu\text{F}$; $C_{\text{NR}} = 1\text{ }\mu\text{F}$; SENSE/FB tied to OUT; and 0P1V, 0P2V, 0P4V, 0P8V, 1P6V, 3P2V, 6P4V1, 6P4V2 pins OPEN, unless otherwise noted.

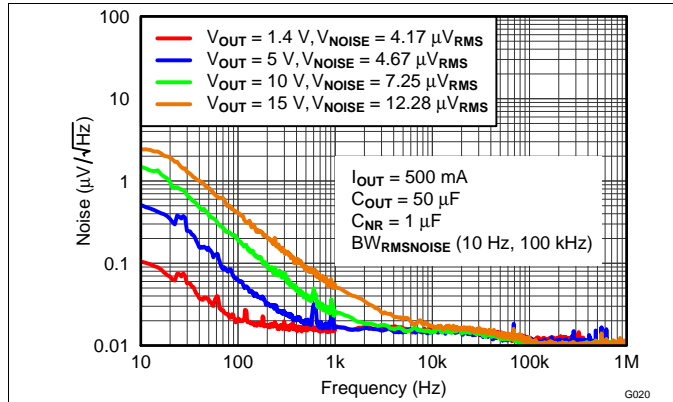

Figure 1. Noise vs Output Voltage

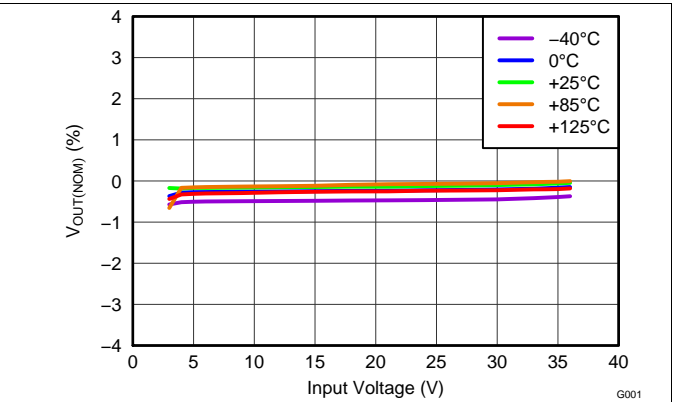

Figure 2. Line Regulation

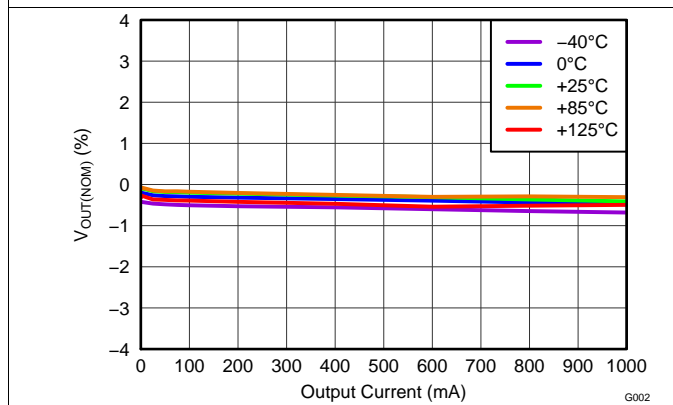

Figure 3. Load Regulation

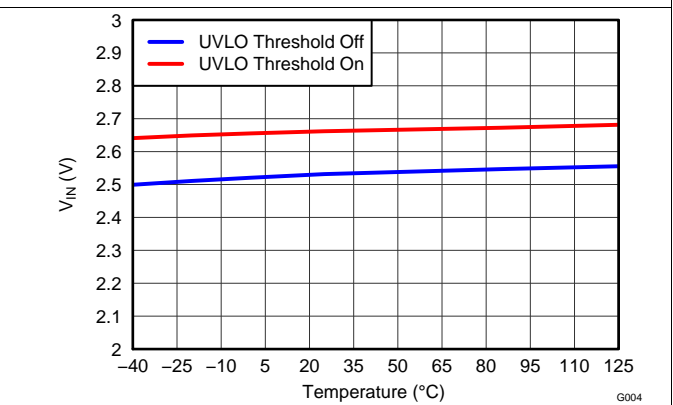

Figure 4. UVLO Threshold vs Temperature

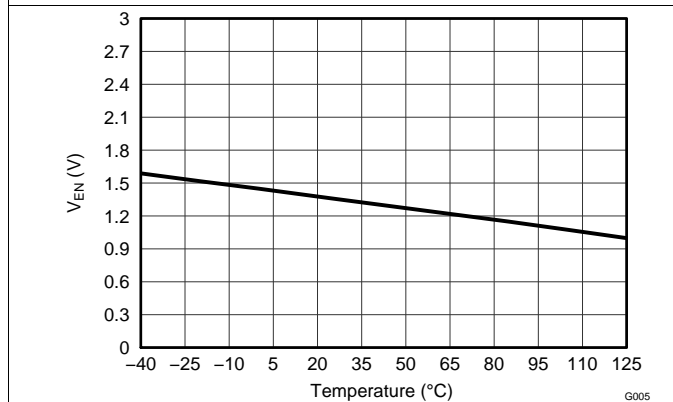

Figure 5. Enable Voltage Threshold vs Temperature

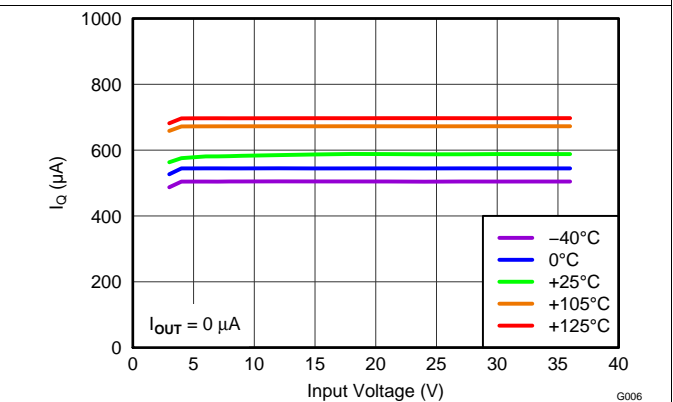

Figure 6. Quiescent Current vs Input Voltage

Typical Characteristics (continued)

At $-40^{\circ}\text{C} \leq T_J \leq 125^{\circ}\text{C}$; $V_I = V_{O(\text{nom})} + 1.0\text{ V}$ or $V_I = 3.0\text{ V}$ (whichever is greater); $V_{\text{EN}} = V_I$; $I_O = 0\text{ mA}$; $C_{\text{IN}} = 10\text{ }\mu\text{F}$; $C_{\text{OUT}} = 10\text{ }\mu\text{F}$; $C_{\text{NR}} = 1\text{ }\mu\text{F}$; SENSE/FB tied to OUT; and 0P1V, 0P2V, 0P4V, 0P8V, 1P6V, 3P2V, 6P4V1, 6P4V2 pins OPEN, unless otherwise noted.

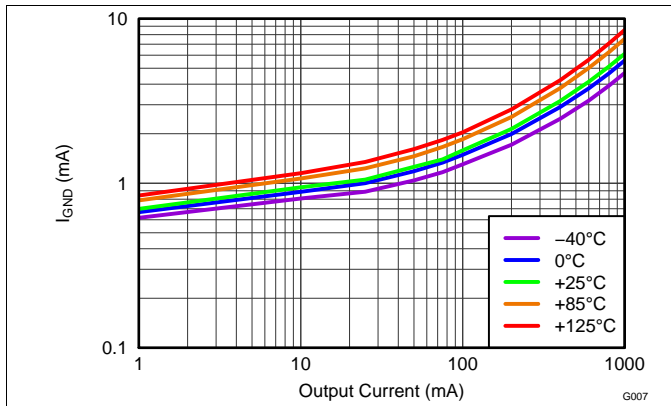

Figure 7. Ground Current vs Output Current

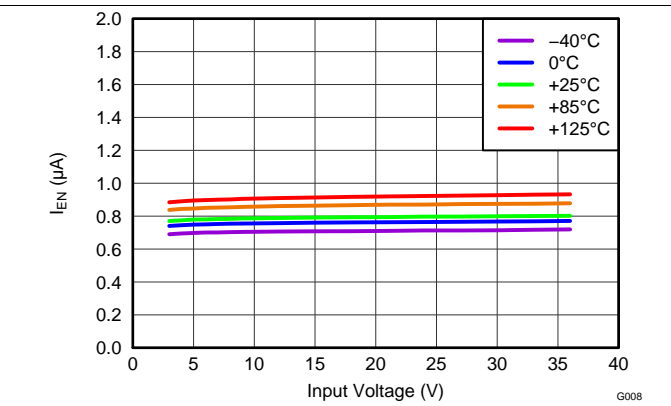

Figure 8. Enable Current vs Input Voltage

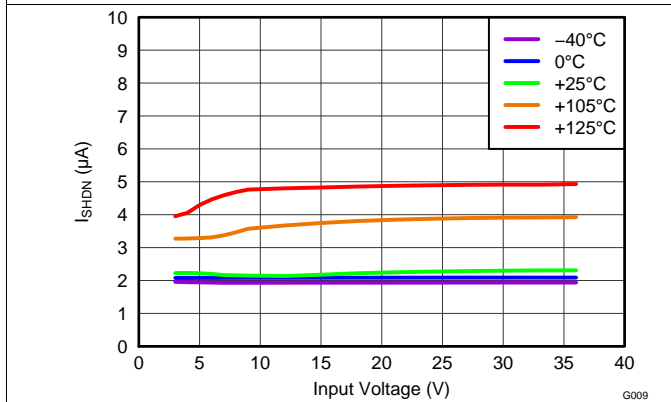

Figure 9. Shutdown Current vs Input Voltage

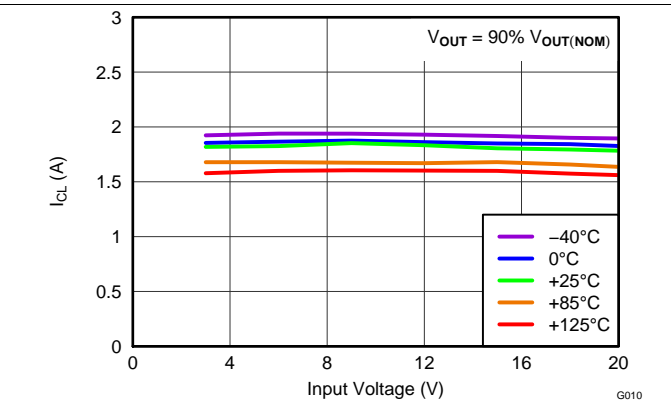

Figure 10. Current Limit vs Input Voltage

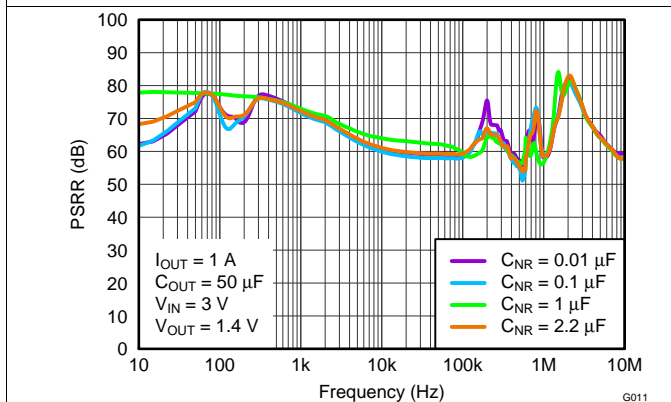

Figure 11. Power-Supply Rejection Ratio vs C_{NR}

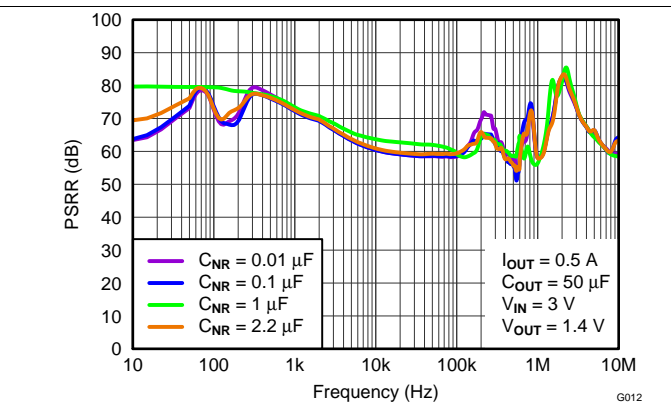

Figure 12. Power-Supply Rejection Ratio vs C_{NR}

Typical Characteristics (continued)

At $-40^{\circ}\text{C} \leq T_J \leq 125^{\circ}\text{C}$; $V_I = V_{O(nom)} + 1.0\text{ V}$ or $V_I = 3.0\text{ V}$ (whichever is greater); $V_{EN} = V_I$; $I_O = 0\text{ mA}$; $C_{IN} = 10\text{ }\mu\text{F}$; $C_{OUT} = 10\text{ }\mu\text{F}$; $C_{NR} = 1\text{ }\mu\text{F}$; SENSE/FB tied to OUT; and 0P1V, 0P2V, 0P4V, 0P8V, 1P6V, 3P2V, 6P4V1, 6P4V2 pins OPEN, unless otherwise noted.

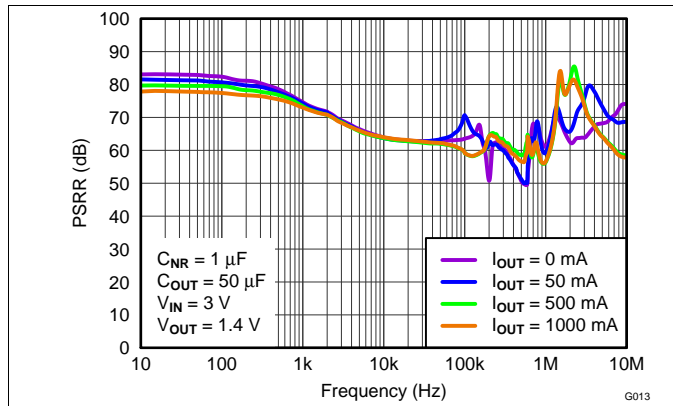

Figure 13. Power-Supply Rejection Ratio vs I_O

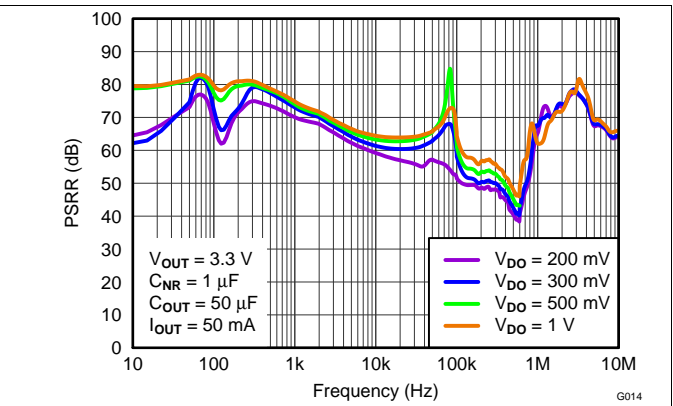

Figure 14. Power-Supply Rejection Ratio vs Dropout

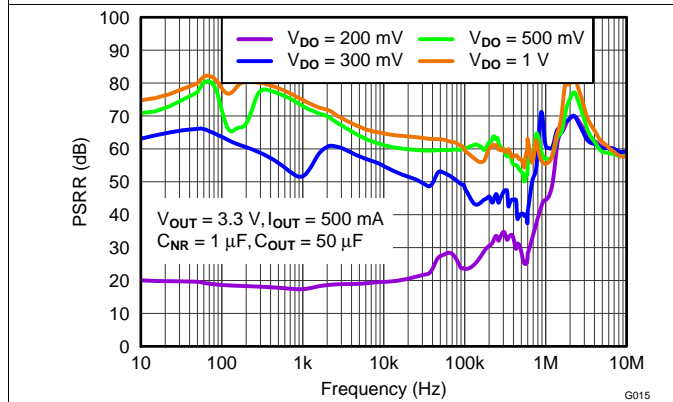

Figure 15. Power-Supply Rejection Ratio vs Dropout

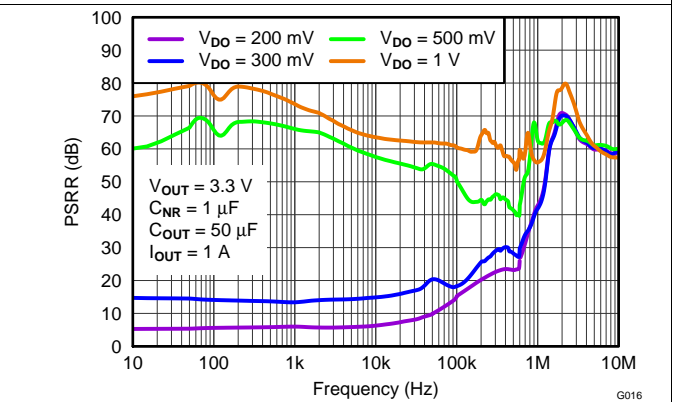

Figure 16. Power-Supply Rejection Ratio vs Dropout

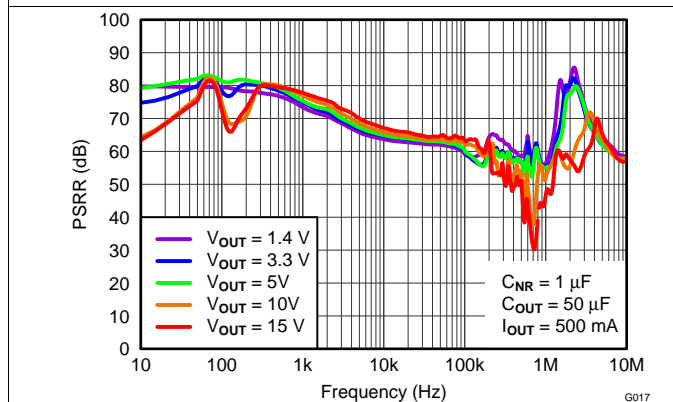

Figure 17. Power-Supply Rejection Ratio vs Output Voltage

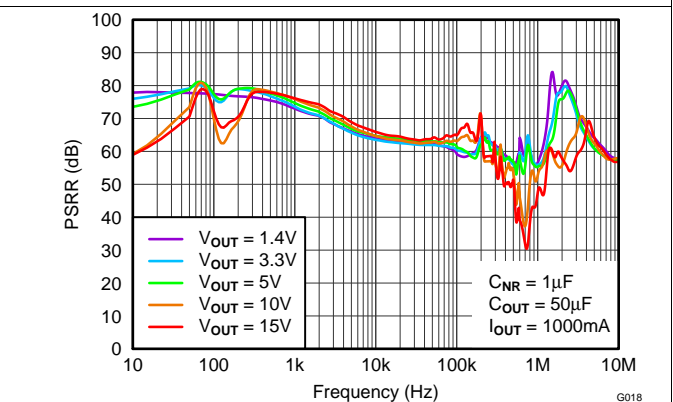

Figure 18. Power-Supply Rejection Ratio vs Output Voltage

Typical Characteristics (continued)

At $-40^{\circ}\text{C} \leq T_J \leq 125^{\circ}\text{C}$; $V_I = V_{O(nom)} + 1.0\text{ V}$ or $V_I = 3.0\text{ V}$ (whichever is greater); $V_{EN} = V_I$; $I_O = 0\text{ mA}$; $C_{IN} = 10\text{ }\mu\text{F}$; $C_{OUT} = 10\text{ }\mu\text{F}$; $C_{NR} = 1\text{ }\mu\text{F}$; SENSE/FB tied to OUT; and 0P1V, 0P2V, 0P4V, 0P8V, 1P6V, 3P2V, 6P4V1, 6P4V2 pins OPEN, unless otherwise noted.

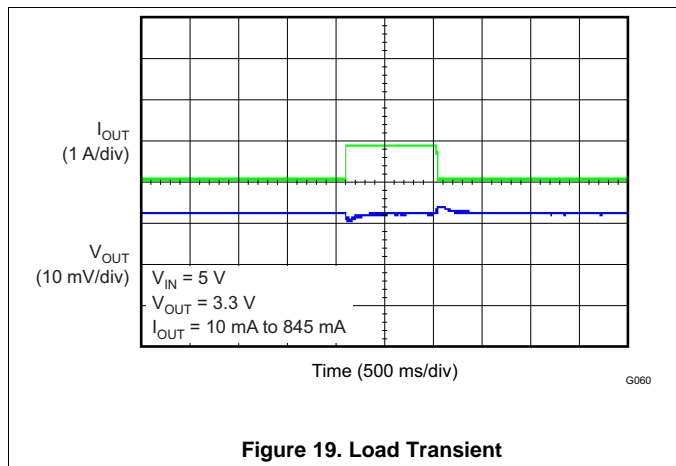

Figure 19. Load Transient

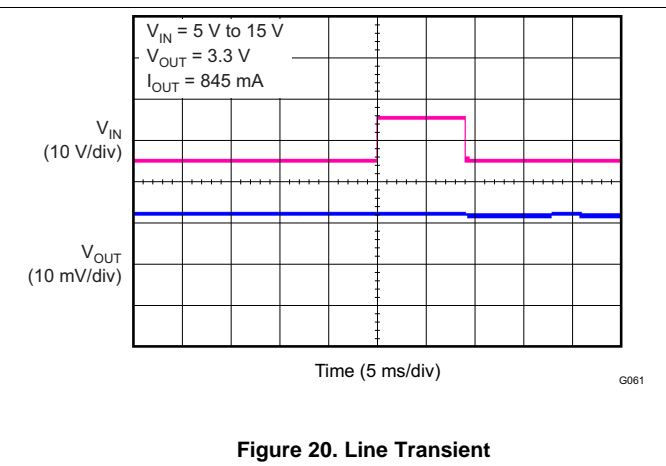

Figure 20. Line Transient

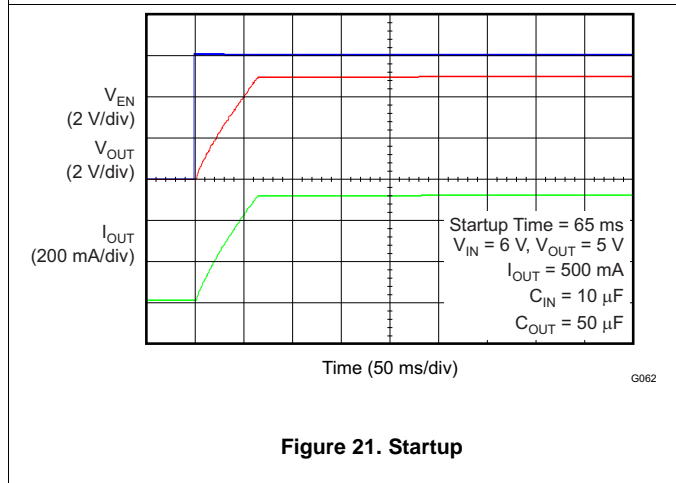

Figure 21. Startup

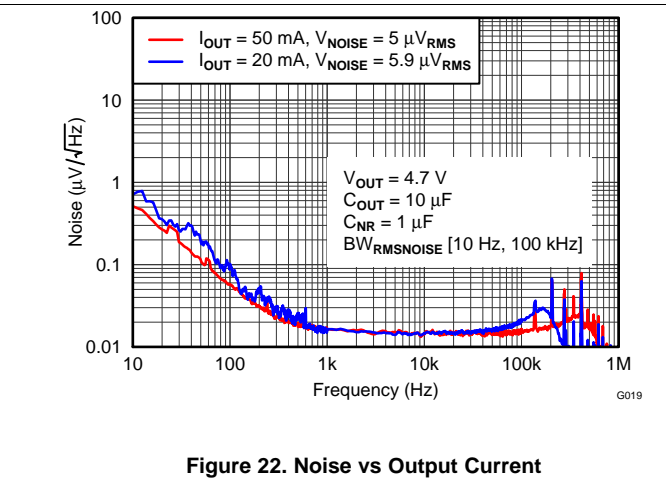

Figure 22. Noise vs Output Current

Feature Description (continued)

7.3.3 Soft-Start And Inrush Current

Soft-start refers to the ramp-up characteristic of the output voltage during LDO turn-on after EN and UVLO have achieved threshold voltage. The noise reduction capacitor serves a dual purpose of both governing output noise reduction and programming the soft-start ramp during turn-on.

Inrush current is defined as the current through the LDO from IN to OUT during the time of the turn-on ramp up. Inrush current then consists primarily of the sum of load and charge current to the output capacitor. Inrush current can be estimated by [Equation 1](#):

$$I_{OUT(t)} = \left[\frac{C_{OUT} \times dV_{OUT}(t)}{dt} \right] + \left[\frac{V_{OUT}(t)}{R_{LOAD}} \right]$$

where:

- $V_{OUT}(t)$ is the instantaneous output voltage of the turn-on ramp,
 - $dV_{OUT}(t)/dt$ is the slope of the V_O ramp, and
 - R_{LOAD} is the resistive load impedance
- (1)

7.4 Device Functional Modes

The TPS7A470x has the following functional modes:

1. **Enabled:** When EN goes above $V_{+EN(HI)}$, the device is enabled.
2. **Disabled:** When EN goes below $V_{+EN(LO)}$, the device is disabled. During this time, OUT is high impedance, and the current into IN does not exceed $I_{(SHDN)}$.

7.5 Programming

7.5.1 ANY-OUT Programmable Output Voltage

Both devices can be used in ANY-OUT mode. For ANY-OUT operation, the TPS7A4700 and TPS7A4701 do not use external resistors to set the output voltage, but use device pins 4, 5, 6, 8, 9, 10, 11, and 12 to program the regulated output voltage. Each pin is either connected to ground (active) or is left open (floating). The ANY-OUT programming is set by [Equation 2](#) as the sum of the internal reference voltage ($V_{(REF)} = 1.4$ V) plus the accumulated sum of the respective voltages assigned to each active pin; that is, 100 mV (pin 12), 200 mV (pin 11), 400 mV (pin 10), 800 mV (pin 9), 1.6 V (pin 8), 3.2 V (pin 6), 6.4 V (pin 5), or 6.4 V (pin 4). [Table 1](#) summarizes these voltage values associated with each active pin setting for reference. By leaving all program pins open, or floating, the output is thereby programmed to the minimum possible output voltage equal to $V_{(REF)}$.

$$V_{OUT} = V_{REF} + (\Sigma \text{ ANY-OUT Pins to Ground})$$
(2)

Table 1. ANY-OUT Programmable Output Voltage

| ANY-OUT PROGRAM PINS (Active Low) | ADDITIVE OUTPUT VOLTAGE LEVEL |
|-----------------------------------|-------------------------------|
| Pin 4 (6P4V2) | 6.4 V |
| Pin 5 (6P4V1) | 6.4 V |
| Pin 6 (3P2) | 3.2 V |
| Pin 8 (1P6) | 1.6 V |
| Pin 9 (0P8) | 800 mV |
| Pin 10 (0P4) | 400 mV |
| Pin 11 (0P2) | 200 mV |
| Pin 12 (0P1) | 100 mV |

Table 2 shows a list of the most common output voltages and the corresponding pin settings. The voltage setting pins have a binary weight; therefore, the output voltage can be programmed to any value from 1.4 V to 20.5 V in 100-mV steps.

Table 2. Common Output Voltages and Corresponding Pin Settings

| V _O (V) | PIN NAMES AND VOLTAGE PER PIN | | | | | | | |
|--------------------|-------------------------------|----------------|----------------|----------------|---------------|---------------|----------------|----------------|
| | 0P1V 100 mV | 0P2V 200 mV | 0P4V 400 mV | 0P8V 800 mV | 1P6V 1.6 V | 3P2V 3.2 V | 6P4V1 6.4 V | 6P4V2 6.4 V |
| 1.4 | Open | Open | Open | Open | Open | Open | Open | Open |
| 1.5 | GND | Open | Open | Open | Open | Open | Open | Open |
| 1.8 | Open | Open | GND | Open | Open | Open | Open | Open |
| 2.5 | GND | GND | Open | GND | Open | Open | Open | Open |
| 3 | Open | Open | Open | Open | GND | Open | Open | Open |
| 3.3 | GND | GND | Open | Open | GND | Open | Open | Open |
| 4.5 | GND | GND | GND | GND | GND | Open | Open | Open |
| 5 | Open | Open | GND | Open | Open | GND | Open | Open |
| 10 | Open | GND | GND | Open | GND | Open | GND | Open |
| 12 | Open | GND | Open | GND | Open | GND | GND | Open |
| 15 | Open | Open | Open | GND | Open | Open | GND | GND |
| 18 | Open | GND | GND | Open | Open | GND | GND | GND |
| 20.5 | GND | GND | GND | GND | GND | GND | GND | GND |

7.5.2 Adjustable Operation (TPS7A4701 Only)

The TPS7A4701 has an output voltage range of 1.4 V to 34 V. For adjustable operation, set the nominal output voltage of the device using two external resistors, as shown in Figure 23.

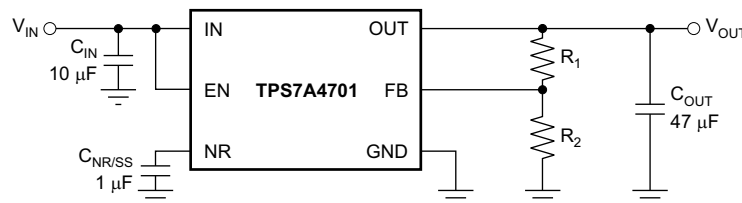

Figure 23. Adjustable Operation for Maximum AC Performance

R₁ and R₂ can be calculated for any output voltage within the operational range. The current through feedback resistor R₂ must be at least 5 µA to ensure stability. Additionally, the current into the FB pin (I_(FB), typically 350 nA) creates an additional output voltage offset that depends on the resistance of R₁. For high-accuracy applications, select R₂ such that the current through R₂ is at least 35 µA to minimize any effects of I_(FB) variation on the output voltage; 10 kΩ is recommended. R₁ can be calculated using Equation 3.

$$R_1 = \frac{V_{OUT} - V_{REF}}{I_{FB} + \frac{V_{REF}}{R_2}}$$

where

- V_{REF} = 1.4 V
- I_{FB} = 350 nA

(3)

Use 0.1% tolerance resistors to minimize the effects of resistor inaccuracy on the output voltage.

Table 3 shows the resistor combinations to achieve some standard rail voltages with commercially-available 1% tolerance resistors. The resulting output voltages yield a nominal error of < 0.5%.

Table 3. Suggested Resistors for Common Voltage Rails

| V _{OUT} | R ₁ , Calculated | R ₁ , Closest 1% Value | R ₂ |
|------------------|-----------------------------|-----------------------------------|----------------|
| 1.4 V | 0 Ω | 0 Ω | ∞ |
| 1.8 V | 2.782 kΩ | 2.8 kΩ | 9.76 kΩ |
| 3.3 V | 13.213 kΩ | 13.3 kΩ | 9.76 kΩ |
| 5 V | 25.650 kΩ | 25.5 kΩ | 10 kΩ |
| 12 V | 77.032 kΩ | 76.8 kΩ | 10.2 kΩ |
| 15 V | 101.733 kΩ | 102 kΩ | 10.5 kΩ |
| 18 V | 118.276 kΩ | 118 kΩ | 10 kΩ |
| 24 V | 164.238 kΩ | 165 kΩ | 10.2 kΩ |

To achieve higher nominal accuracy, two resistors can be used in the place of R₁. Select the two resistor values such that the sum results in a value as close as possible to the calculated R₁ value.

There are several alternative ways to set the output voltage. The program pins can be pulled low using external general-purpose input/output pins (GPIOs), or can be hardwired by the given layout of the printed circuit board (PCB) to set the ANY-OUT voltage. The [TPS7A4701 evaluation module \(EVM\)](#), available for purchase from [the TI eStore](#), allows the output voltage to be programmed using jumpers.

8 Application and Implementation

NOTE

Information in the following applications sections is not part of the TI component specification, and TI does not warrant its accuracy or completeness. TI's customers are responsible for determining suitability of components for their purposes. Customers should validate and test their design implementation to confirm system functionality.

8.1 Application Information

The TPS7A740x is a high-voltage, low-noise, 1-A LDO. Low-noise performance makes this LDO ideal for providing rail voltages to noise-sensitive loads, such as PLLs, oscillators, and high-speed ADCs.

8.2 Typical Application

Output voltage is set by grounding the appropriate control pins, as shown in [Figure 24](#). When grounded, all control pins add a specific voltage on top of the internal reference voltage ($V_{REF} = 1.4\text{ V}$). For example, when grounding pins 0P1V, 0P2V, and 1P6V, the voltage values 0.1 V, 0.2 V, and 1.6 V are added to the 1.4-V internal reference voltage for $V_{O(nom)}$ equal to 3.3 V, as described in the [Programming](#) section.

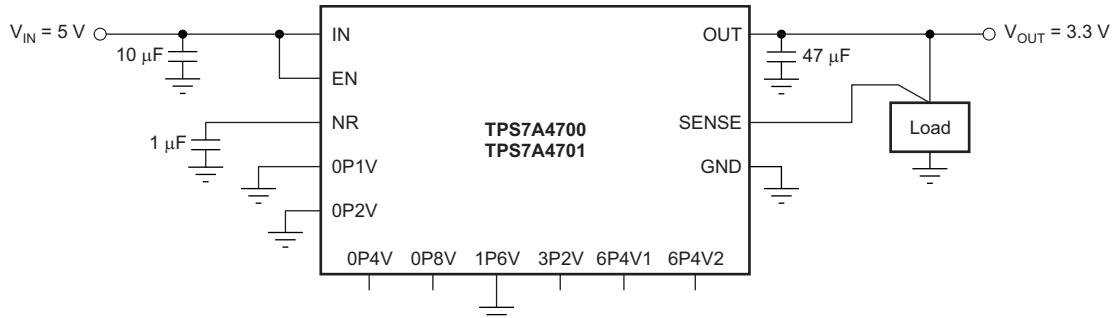

Figure 24. Typical Application, $V_{OUT} = 3.3\text{ V}$

8.2.1 Design Requirements

| PARAMETER | DESIGN REQUIREMENT |
|--------------------------------------|---------------------|
| Input Voltage | 5.0 V, $\pm 10\%$ |
| Output Voltage | 3.3 V, $\pm 3\%$ |
| Output Current | 500 mA |
| Peak-to-Peak Noise, 10 Hz to 100 kHz | 50 $\mu\text{Vp-p}$ |

8.2.2 Detailed Design Procedure

8.2.2.1 Capacitor Recommendations

These LDOs are designed to be stable using low equivalent series resistance (ESR), ceramic capacitors at the input, output, and at the noise reduction pin (NR, pin 14). Multilayer ceramic capacitors have become the industry standard for these types of applications and are recommended here, but must be used with good judgment. Ceramic capacitors that employ X7R-, X5R-, and COG-rated dielectric materials provide relatively good capacitive stability across temperature, but the use of Y5V-rated capacitors is discouraged precisely because the capacitance varies so widely. In all cases, ceramic capacitance varies a great deal with operating voltage and the design engineer must be aware of these characteristics. It is recommended to apply a 50% derating of the nominal capacitance in the design.

Attention must be given to the input capacitance to minimize transient input droop during load current steps because the TPS7A470x has a very fast load transient response. Large input capacitors are necessary for good transient load response, and have no detrimental influence on the stability of the device. Note, however, that using large ceramic input capacitances can also cause unwanted ringing at the output if the input capacitor, in combination with the wire lead inductance, creates a high-Q peaking effect during transients. For example, a 5-nH lead inductance and a 10- μ F input capacitor form an LC filter with a resonance frequency of 712 kHz at the edge of the control loop bandwidth. Short, well-designed interconnect leads to the up-stream supply minimize this effect without adding damping. Damping of unwanted ringing can be accomplished by using a tantalum capacitor, with a few hundred milliohms of ESR, in parallel with the ceramic input capacitor.

8.2.2.1.1 Input and Output Capacitor Requirements

The TPS7A470x is designed and characterized for operation with ceramic capacitors of 10 μ F or greater at the input and output. Optimal noise performance is characterized using a total output capacitor value of 50 μ F. Note especially that input and output capacitances must be located as near as practical to the respective input and output pins.

8.2.2.1.2 Noise Reduction Capacitor (C_{NR})

The noise reduction capacitor, connected to the NR pin of the LDO, forms an RC filter for filtering out noise that might ordinarily be amplified by the control loop and appear on the output voltage. Larger capacitances, up to 1 μ F, affect noise reduction at lower frequencies while also tending to further reduce noise at higher frequencies. Note that C_{NR} also serves a secondary purpose in programming the turn-on rise time of the output voltage and thereby controls the turn-on surge current.

8.2.2.2 Dropout Voltage (V_{DO})

Generally speaking, the dropout voltage often refers to the voltage difference between the input and output voltage ($V_{DO} = V_I - V_O$). However, in the [Electrical Characteristics](#) V_{DO} is defined as the $V_I - V_O$ voltage at the rated current (I_{RATED}), where the main current pass-FET is fully on in the Ohmic region of operation and is characterized by the classic $R_{DS(on)}$ of the FET. V_{DO} indirectly specifies a minimum input voltage above the nominal programmed output voltage at which the output voltage is expected to remain within its accuracy boundary. If the input falls below this V_{DO} limit ($V_I < V_O + V_{DO}$), then the output voltage decreases in order to follow the input voltage.

Dropout voltage is always determined by the $R_{DS(on)}$ of the main pass-FET. Therefore, if the LDO operates below the rated current, the V_{DO} is directly proportional to the output current and can be reduced by the same factor. The $R_{DS(on)}$ for the TPS7A470x can be calculated using [Equation 4](#):

$$R_{DS(ON)} = \frac{V_{DO}}{I_{RATED}} \quad (4)$$

8.2.2.3 Output Voltage Accuracy

The output voltage accuracy specifies minimum and maximum output voltage error, relative to the expected nominal output voltage stated as a percent. This accuracy error typically includes the errors introduced by the internal reference and the load and line regulation across the full range of rated load and line operating conditions over temperature, unless otherwise specified by the [Electrical Characteristics](#). Output voltage accuracy also accounts for all variations between manufacturing lots.

8.2.2.4 Startup

The startup time for the TPS7A470x depends on the output voltage and the capacitance of the C_{NR} capacitor. [Equation 5](#) calculates the startup time for a typical device.

$$t_{SS} = 100,000 \cdot C_{NR} \cdot \ln\left(\frac{V_R + 5}{5}\right)$$

where

- C_{NR} = capacitance of the C_{NR} capacitor
 - $V_R = V_O$ voltage if using the ANY-OUT configuration, or 1.4 V if using the adjustable configuration
- (5)

8.2.2.5 AC Performance

AC performance of the LDO is typically understood to include power-supply rejection ratio, load step transient response, and output noise. These metrics are primarily a function of open-loop gain and bandwidth, phase margin, and reference noise.

8.2.2.5.1 Power-Supply Rejection Ratio (PSRR)

PSRR is a measure of how well the LDO control loop rejects ripple noise from the input source to make the dc output voltage as noise-free as possible across the frequency spectrum (usually 10 Hz to 10 MHz). Equation 6 gives the PSRR calculation as a function of frequency where input noise voltage $[V_{S(IN)}(f)]$ and output noise voltage $[V_{S(OUT)}(f)]$ are understood to be purely ac signals.

$$\text{PSRR (dB)} = 20 \text{ Log}_{10} \left[\frac{V_{S(IN)}(f)}{V_{S(OUT)}(f)} \right] \quad (6)$$

Noise that couples from the input to the internal reference voltage for the control loop is also a primary contributor to reduced PSRR magnitude and bandwidth. This reference noise is greatly filtered by the noise reduction capacitor at the NR pin of the LDO in combination with an internal filter resistor (R_{SS}) for optimal PSRR.

The LDO is often employed not only as a dc/dc regulator, but also to provide exceptionally clean power-supply voltages that are free of noise and ripple to power-sensitive system components. This usage is especially true for the TPS7A470x.

8.2.2.5.2 Load Step Transient Response

The load step transient response is the output voltage response by the LDO to a step change in load current whereby output voltage regulation is maintained. The worst-case response is characterized for a load step of 10 mA to 1 A (at 1 A per microsecond) and shows a classic, critically-damped response of a very stable system. The voltage response shows a small dip in the output voltage when charge is initially depleted from the output capacitor and then the output recovers as the control loop adjusts itself. The depth of the charge depletion immediately after the load step is directly proportional to the amount of output capacitance. However, to some extent, the speed of recovery is inversely proportional to that same output capacitance. In other words, larger output capacitances act to decrease any voltage dip or peak occurring during a load step but also decrease the control-loop bandwidth, thereby slowing response.

The worst-case, off-loading step characterization occurs when the current step transitions from 1 A to 0 mA. Initially, the LDO loop cannot respond fast enough to prevent a small increase in output voltage charge on the output capacitor. Because the LDO cannot sink charge current, the control loop must turn off the main pass-FET to wait for the charge to deplete, thus giving the off-load step its typical monotonic decay (which appears triangular in shape).

8.2.2.5.3 Noise

The TPS7A470x is designed, in particular, for system applications where minimizing noise on the power-supply rail is critical to system performance. This scenario is the case for phase-locked loop (PLL)-based clocking circuits for instance, where minimum phase noise is all important, or in-test and measurement systems where even small power-supply noise fluctuations can distort instantaneous measurement accuracy. Because the TPS7A470x is also designed for higher voltage industrial applications, the noise characteristic is well designed to minimize any increase as a function of the output voltage.

LDO noise is defined as the internally-generated intrinsic noise created by the semiconductor circuits alone. This noise is the sum of various types of noise (such as shot noise associated with current-through-pin junctions, thermal noise caused by thermal agitation of charge carriers, flicker or 1/f noise that is a property of resistors and dominates at lower frequencies as a function of 1/f, burst noise, and avalanche noise).

To calculate the LDO RMS output noise, a spectrum analyzer must first measure the spectral noise across the bandwidth of choice (typically 10 Hz to 100 kHz in units of $\mu\text{V}/\sqrt{\text{Hz}}$). The RMS noise is then calculated in the usual manner as the integrated square root of the squared spectral noise over the band, then averaged by the bandwidth.

8.2.3 Application Curves

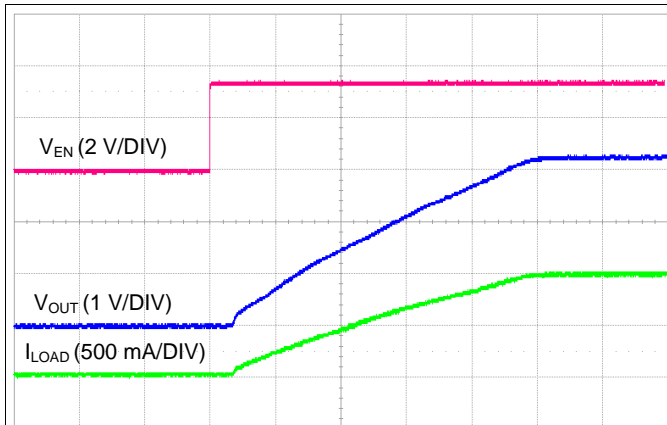

Figure 25. Startup with EN Pin rising (10 ms/DIV)

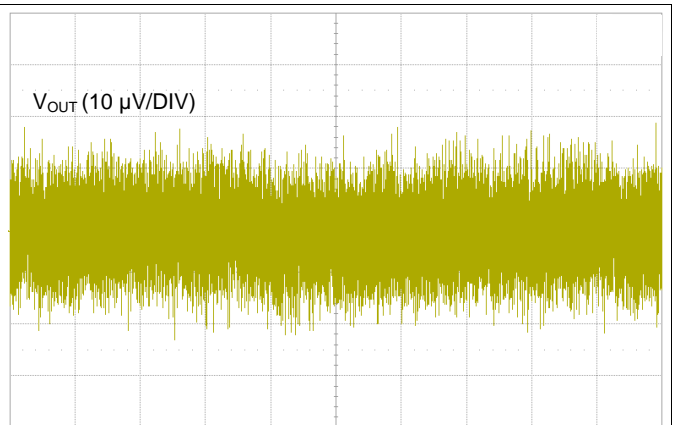

Figure 26. Output Noise Voltage, 10 Hz to 100 kHz (10 ms/DIV)

9 Power Supply Recommendations

The device is designed to operate from an input voltage supply range of 3 V to 35 V. If the input supply is noisy, additional input capacitors with low ESR can help improve the output noise performance.

9.1 Power Dissipation (P_D)

Power dissipation must be considered in the PCB design. In order to minimize risk of device operation above 125°C, use as much copper area as available for thermal dissipation. Do not locate other power-dissipating devices near the LDO.

Power dissipation in the regulator depends on the input to output voltage difference and load conditions. P_D can be calculated using [Equation 7](#):

$$P_D = (V_{OUT} - V_{IN}) \times I_{OUT} \quad (7)$$

It is important to note that power dissipation can be minimized, and thus greater efficiency achieved, by proper selection of the system voltage rails. Proper selection allows the minimum input voltage necessary for output regulation to be obtained.

The primary heat conduction path for the QFN (RGW) package is through the thermal pad to the PCB. The thermal pad must be soldered to a copper pad area under the device. Thermal vias are recommended to improve the thermal conduction to other layers of the PCB.

The maximum power dissipation determines the maximum allowable junction temperature (T_J) for the device. Power dissipation and junction temperature are most often related by the junction-to-ambient thermal resistance (θ_{JA}) of the combined PCB and device package and the temperature of the ambient air (T_A), according to [Equation 8](#).

$$T_J = T_A + (\theta_{JA} \times P_D) \quad (8)$$

Unfortunately, this thermal resistance (θ_{JA}) depends primarily on the heat-spreading capability built into the particular PCB design, and therefore varies according to the total copper area, copper weight, and location of the spreading planes. The θ_{JA} recorded in the [Thermal Information](#) table is determined by the JEDEC standard, PCB, and copper-spreading area and is to be used only as a relative measure of package thermal performance. Note that for a well-designed thermal layout, θ_{JA} is actually the sum of the QFN package junction-to-case (bottom) thermal resistance (θ_{JCbot}) plus the thermal resistance contribution by the PCB copper. By knowing θ_{JCbot} , the minimum amount of appropriate heat sinking can be used to estimate θ_{JA} with [Figure 27](#). θ_{JCbot} can be found in the [Thermal Information](#) table.

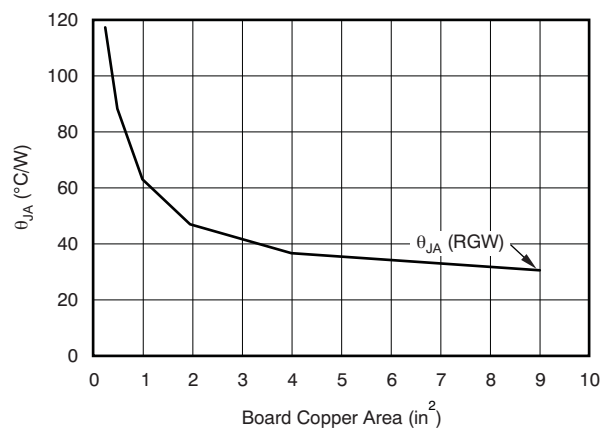

NOTE: θ_{JA} value at a board size of 9-in² (that is, 3-in × 3-in) is a JEDEC standard.

Figure 27. θ_{JA} vs Board Size

10.3 Thermal Protection

The TPS7A470x contains a thermal shutdown protection circuit to turn off the output current when excessive heat is dissipated in the LDO. Thermal shutdown occurs when the thermal junction temperature (T_J) of the main pass-FET exceeds 170°C (typical). Thermal shutdown hysteresis assures that the LDO again resets (turns on) when the temperature falls to 150°C (typical). Because the TPS7A470x is capable of supporting high input voltages, a great deal of power can be expected to be dissipated across the device at low output voltages, which causes a thermal shutdown. The thermal time-constant of the semiconductor die is fairly short, and thus the output oscillates on and off at a high rate when thermal shutdown is reached until power dissipation is reduced.

For reliable operation, the junction temperature must be limited to a maximum of 125°C. To estimate the thermal margin in a given layout, increase the ambient temperature until the thermal protection shutdown is triggered using worst-case load and highest input voltage conditions. For good reliability, thermal shutdown must be designed to occur at least 45°C above the maximum expected ambient temperature condition for the application. This configuration produces a worst-case junction temperature of 125°C at the highest expected ambient temperature and worst-case load.

The internal protection circuitry of the TPS7A470x is designed to protect against thermal overload conditions. The circuitry is not intended to replace proper heat sinking. Continuously running the TPS7A470x into thermal shutdown degrades device reliability.

10.4 Estimating Junction Temperature

JEDEC standards now recommend the use of PSI thermal metrics to estimate the junction temperatures of the LDO while in-circuit on a typical PCB board application. These metrics are not strictly speaking thermal resistances, but rather offer practical and relative means of estimating junction temperatures. These PSI metrics are determined to be significantly independent of copper-spreading area. The key thermal metrics (Ψ_{JT} and Ψ_{JB}) are given in the [Thermal Information](#) table and are used in accordance with [Equation 9](#).

$$\Psi_{JT}: T_J = T_T + \Psi_{JT} \times P_D$$

$$\Psi_{JB}: T_J = T_B + \Psi_{JB} \times P_D$$

where:

- P_D is the power dissipated as explained in [Equation 7](#),
- T_T is the temperature at the center-top of the device package, and
- T_B is the PCB surface temperature measured 1 mm from the device package and centered on the package edge

(9)

11 器件和文档支持

11.1 文档支持

11.1.1 相关文档

相关文档如下（下载网站 www.ti.com.cn）：

- 《TPS7A47XXEVM-094 评估模块》，用户指南 [SLVU741A](#)
- 《使用前馈电容器和低压降稳压器的优缺点》，应用手册 [SBVA042](#)

11.2 相关链接

表 4 列出了快速访问链接。范围包括技术文档、支持与社区资源、工具和软件，并且可以快速访问样片或购买链接。

表 4. 相关链接

| 部件 | 产品文件夹 | 样片与购买 | 技术文档 | 工具与软件 | 支持与社区 |
|-----------|-----------------------|-----------------------|-----------------------|-----------------------|-----------------------|
| TPS7A4700 | 请单击此处 | 请单击此处 | 请单击此处 | 请单击此处 | 请单击此处 |
| TPS7A4701 | 请单击此处 | 请单击此处 | 请单击此处 | 请单击此处 | 请单击此处 |

11.3 商标

ANY-OUT, PowerPAD are trademarks of Texas Instruments.
All other trademarks are the property of their respective owners.

11.4 静电放电警告



这些装置包含有限的内置 ESD 保护。存储或装卸时，应将导线一起截短或将装置放置于导电泡棉中，以防止 MOS 门极遭受静电损伤。

11.5 术语表

[SLYZ022](#) — TI 术语表。

这份术语表列出并解释术语、首字母缩略词和定义。

12 机械封装和可订购信息

以下页中包括机械封装和可订购信息。 这些信息是针对指定器件可提供的最新数据。 这些数据会在无通知且不对本文档进行修订的情况下发生改变。 欲获得该数据表的浏览器版本，请查阅左侧的导航栏。

PACKAGING INFORMATION

| Orderable part number | Status (1) | Material type (2) | Package Pins | Package qty Carrier | RoHS (3) | Lead finish/ Ball material (4) | MSL rating/ Peak reflow (5) | Op temp (°C) | Part marking (6) |
|-------------------------------|---------------|----------------------|-----------------|-----------------------|-------------|--------------------------------------|-----------------------------------|--------------|---------------------|
| TPS7A4700RGWR | Active | Production | VQFN (RGW) 20 | 3000 LARGE T&R | Yes | NIPDAU | Level-2-260C-1 YEAR | -40 to 125 | PXSQ |
| TPS7A4700RGWR.B | Active | Production | VQFN (RGW) 20 | 3000 LARGE T&R | Yes | NIPDAU | Level-2-260C-1 YEAR | -40 to 125 | PXSQ |
| TPS7A4700RGWRG4.B | Active | Production | VQFN (RGW) 20 | 3000 LARGE T&R | Yes | NIPDAU | Level-2-260C-1 YEAR | -40 to 125 | PXSQ |
| TPS7A4700RGWT | Active | Production | VQFN (RGW) 20 | 250 SMALL T&R | Yes | NIPDAU | Level-2-260C-1 YEAR | -40 to 125 | PXSQ |
| TPS7A4700RGWT.B | Active | Production | VQFN (RGW) 20 | 250 SMALL T&R | Yes | NIPDAU | Level-2-260C-1 YEAR | -40 to 125 | PXSQ |
| TPS7A4701RGWR | Active | Production | VQFN (RGW) 20 | 3000 LARGE T&R | Yes | NIPDAU | Level-2-260C-1 YEAR | -40 to 125 | 7A4701 |
| TPS7A4701RGWR.B | Active | Production | VQFN (RGW) 20 | 3000 LARGE T&R | Yes | NIPDAU | Level-2-260C-1 YEAR | -40 to 125 | 7A4701 |
| TPS7A4701RGWRG4.B | Active | Production | VQFN (RGW) 20 | 3000 LARGE T&R | Yes | NIPDAU | Level-2-260C-1 YEAR | -40 to 125 | 7A4701 |
| TPS7A4701RGWT | Active | Production | VQFN (RGW) 20 | 250 SMALL T&R | Yes | NIPDAU | Level-1-260C-UNLIM | -40 to 125 | 7A4701 |
| TPS7A4701RGWT.B | Active | Production | VQFN (RGW) 20 | 250 SMALL T&R | Yes | NIPDAU | Level-1-260C-UNLIM | -40 to 125 | 7A4701 |

(1) **Status:** For more details on status, see our [product life cycle](#).

(2) **Material type:** When designated, preproduction parts are prototypes/experimental devices, and are not yet approved or released for full production. Testing and final process, including without limitation quality assurance, reliability performance testing, and/or process qualification, may not yet be complete, and this item is subject to further changes or possible discontinuation. If available for ordering, purchases will be subject to an additional waiver at checkout, and are intended for early internal evaluation purposes only. These items are sold without warranties of any kind.

(3) **RoHS values:** Yes, No, RoHS Exempt. See the [TI RoHS Statement](#) for additional information and value definition.

(4) **Lead finish/Ball material:** Parts may have multiple material finish options. Finish options are separated by a vertical ruled line. Lead finish/Ball material values may wrap to two lines if the finish value exceeds the maximum column width.

(5) **MSL rating/Peak reflow:** The moisture sensitivity level ratings and peak solder (reflow) temperatures. In the event that a part has multiple moisture sensitivity ratings, only the lowest level per JEDEC standards is shown. Refer to the shipping label for the actual reflow temperature that will be used to mount the part to the printed circuit board.

(6) **Part marking:** There may be an additional marking, which relates to the logo, the lot trace code information, or the environmental category of the part.

Multiple part markings will be inside parentheses. Only one part marking contained in parentheses and separated by a "~" will appear on a part. If a line is indented then it is a continuation of the previous line and the two combined represent the entire part marking for that device.

Important Information and Disclaimer: The information provided on this page represents TI's knowledge and belief as of the date that it is provided. TI bases its knowledge and belief on information provided by third parties, and makes no representation or warranty as to the accuracy of such information. Efforts are underway to better integrate information from third parties. TI has taken and continues to take reasonable steps to provide representative

and accurate information but may not have conducted destructive testing or chemical analysis on incoming materials and chemicals. TI and TI suppliers consider certain information to be proprietary, and thus CAS numbers and other limited information may not be available for release.

In no event shall TI's liability arising out of such information exceed the total purchase price of the TI part(s) at issue in this document sold by TI to Customer on an annual basis.

OTHER QUALIFIED VERSIONS OF TPS7A47 :

- Automotive : [TPS7A47-Q1](#)

NOTE: Qualified Version Definitions:

- Automotive - Q100 devices qualified for high-reliability automotive applications targeting zero defects

TAPE AND REEL INFORMATION

QUADRANT ASSIGNMENTS FOR PIN 1 ORIENTATION IN TAPE

*All dimensions are nominal

| Device | Package Type | Package Drawing | Pins | SPQ | Reel Diameter (mm) | Reel Width W1 (mm) | A0 (mm) | B0 (mm) | K0 (mm) | P1 (mm) | W (mm) | Pin1 Quadrant |
|---------------|--------------|-----------------|------|------|--------------------|--------------------|---------|---------|---------|---------|--------|---------------|
| TPS7A4700RGWR | VQFN | RGW | 20 | 3000 | 330.0 | 12.4 | 5.3 | 5.3 | 1.1 | 8.0 | 12.0 | Q2 |
| TPS7A4700RGWT | VQFN | RGW | 20 | 250 | 180.0 | 12.4 | 5.3 | 5.3 | 1.1 | 8.0 | 12.0 | Q2 |
| TPS7A4701RGWR | VQFN | RGW | 20 | 3000 | 330.0 | 12.4 | 5.3 | 5.3 | 1.1 | 8.0 | 12.0 | Q2 |
| TPS7A4701RGWT | VQFN | RGW | 20 | 250 | 180.0 | 12.4 | 5.3 | 5.3 | 1.1 | 8.0 | 12.0 | Q2 |

TAPE AND REEL BOX DIMENSIONS

*All dimensions are nominal

| Device | Package Type | Package Drawing | Pins | SPQ | Length (mm) | Width (mm) | Height (mm) |
|---------------|--------------|-----------------|------|------|-------------|------------|-------------|
| TPS7A4700RGWR | VQFN | RGW | 20 | 3000 | 346.0 | 346.0 | 33.0 |
| TPS7A4700RGWT | VQFN | RGW | 20 | 250 | 210.0 | 185.0 | 35.0 |
| TPS7A4701RGWR | VQFN | RGW | 20 | 3000 | 346.0 | 346.0 | 33.0 |
| TPS7A4701RGWT | VQFN | RGW | 20 | 250 | 210.0 | 185.0 | 35.0 |

GENERIC PACKAGE VIEW

RGW 20

VQFN - 1 mm max height

5 x 5, 0.65 mm pitch

PLASTIC QUAD FLATPACK - NO LEAD

This image is a representation of the package family, actual package may vary.
Refer to the product data sheet for package details.

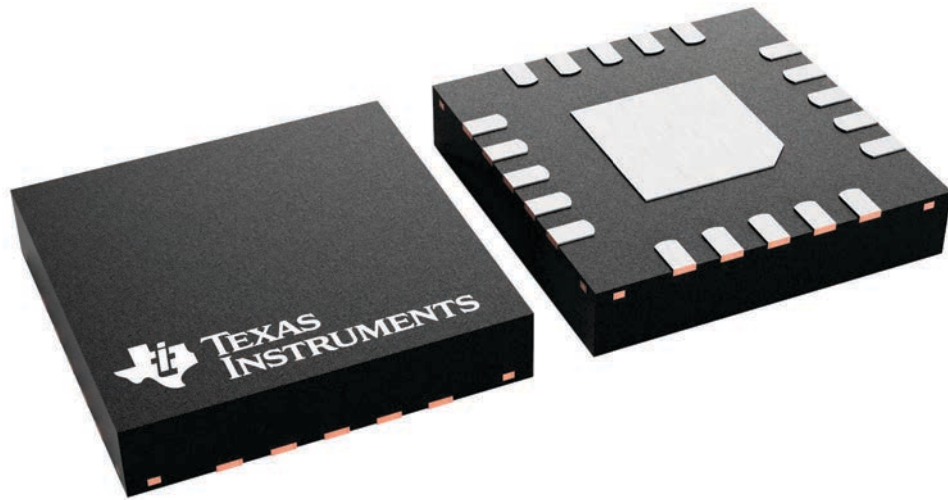

4227157/A

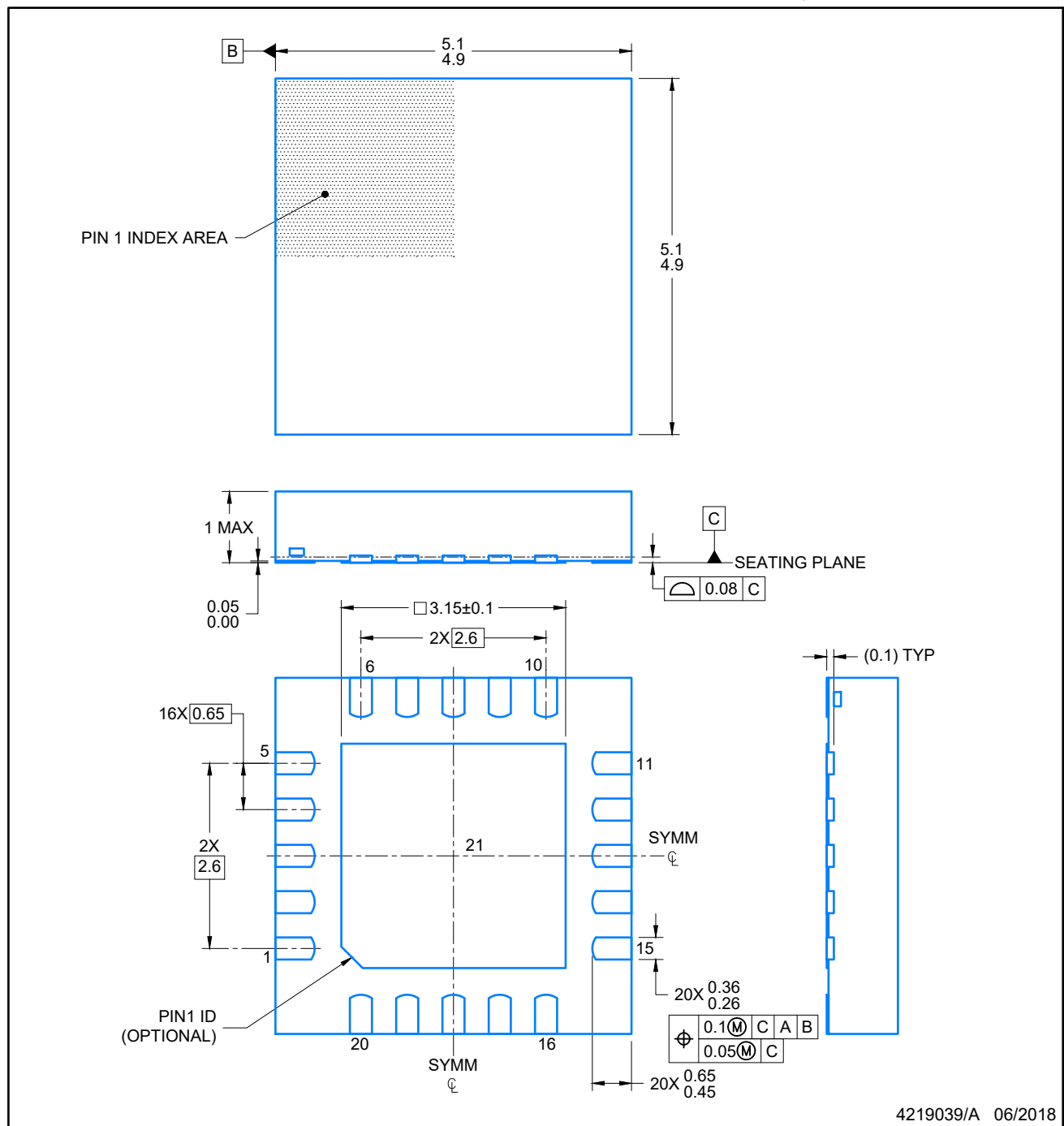

NOTES:

1. All linear dimensions are in millimeters. Any dimensions in parenthesis are for reference only. Dimensioning and tolerancing per ASME Y14.5M.
2. This drawing is subject to change without notice.
3. The package thermal pad must be soldered to the printed circuit board for optimal thermal and mechanical performance.

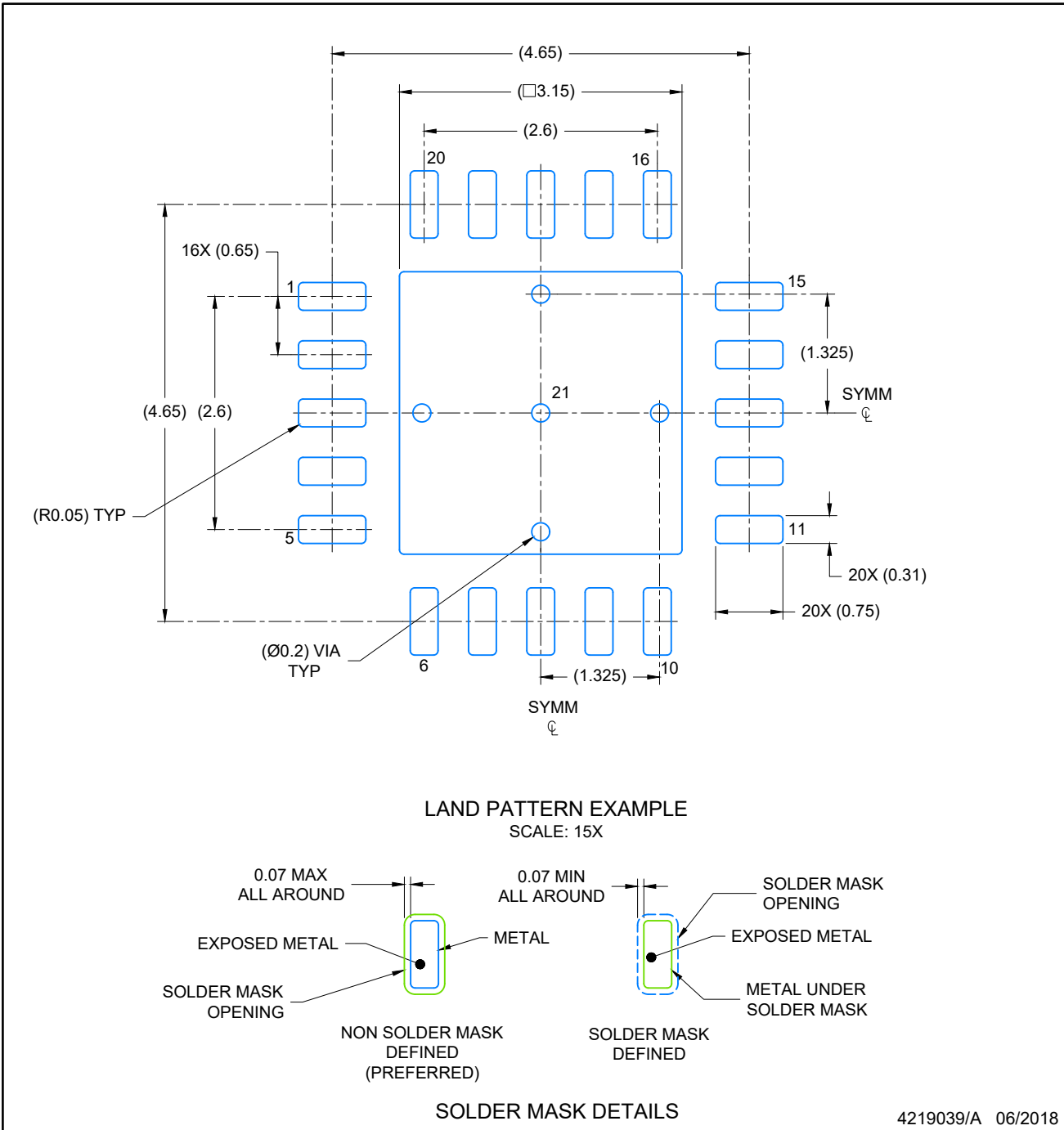

NOTES: (continued)

4. This package is designed to be soldered to a thermal pad on the board. For more information, see Texas Instruments literature number SLUA271 (www.ti.com/lit/sluea271).
5. Vias are optional depending on application, refer to device data sheet. If any vias are implemented, refer to their locations shown on this view. It is recommended that vias under paste be filled, plugged or tented.

EXAMPLE STENCIL DESIGN

VQFN - 1 mm max height

RGW0020A

PLASTIC QUAD FLATPACK-NO LEAD

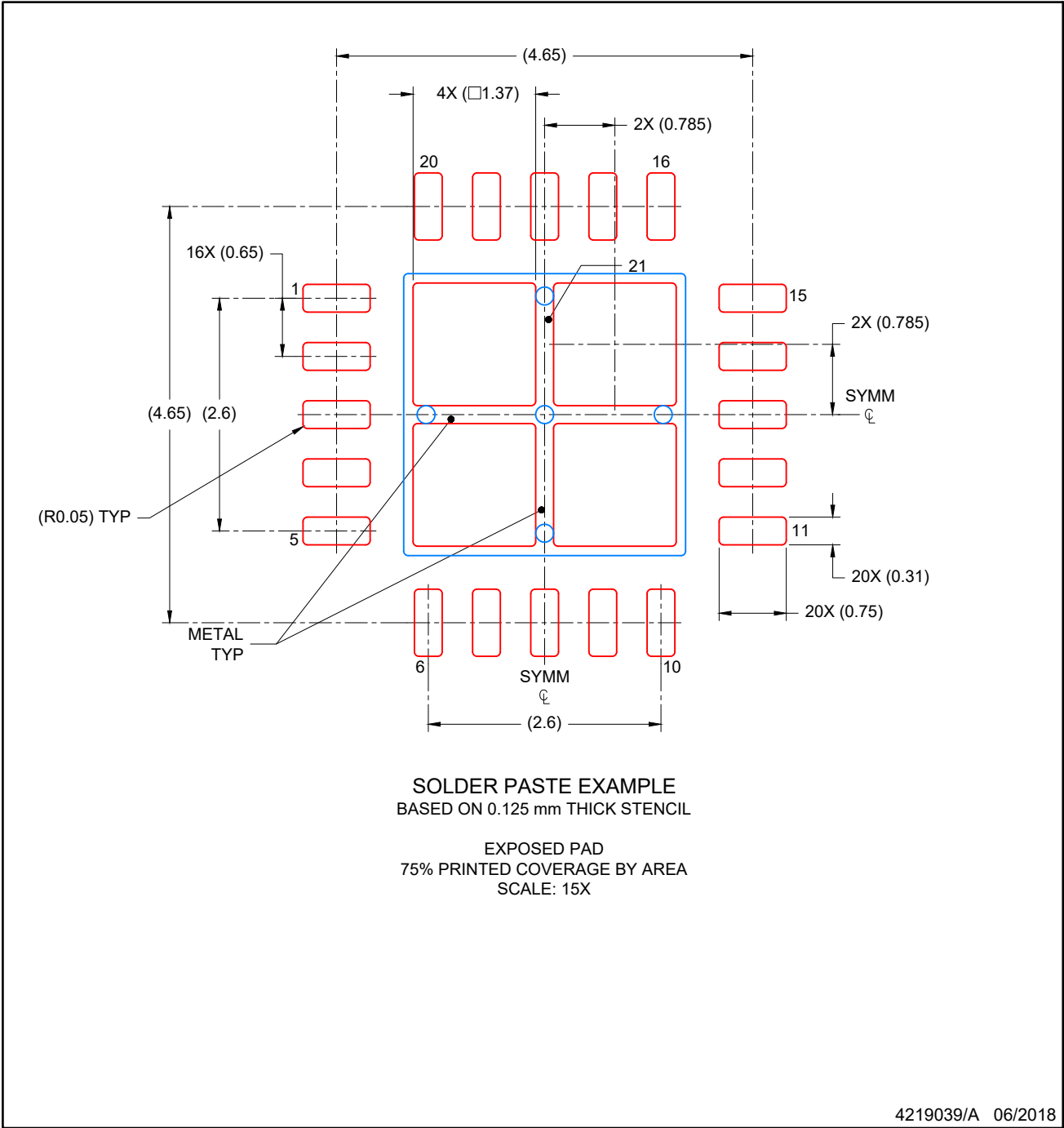

NOTES: (continued)

- 6. Laser cutting apertures with trapezoidal walls and rounded corners may offer better paste release. IPC-7525 may have alternate design recommendations.

重要通知和免责声明

TI“按原样”提供技术和可靠性数据（包括数据表）、设计资源（包括参考设计）、应用或其他设计建议、网络工具、安全信息和其他资源，不保证没有瑕疵且不做任何明示或暗示的担保，包括但不限于对适销性、某特定用途方面的适用性或不侵犯任何第三方知识产权的暗示担保。

这些资源可供使用 TI 产品进行设计的熟练开发人员使用。您将自行承担以下全部责任：(1) 针对您的应用选择合适的 TI 产品，(2) 设计、验证并测试您的应用，(3) 确保您的应用满足相应标准以及任何其他功能安全、信息安全、监管或其他要求。

这些资源如有变更，恕不另行通知。TI 授权您仅可将这些资源用于研发本资源所述的 TI 产品的相关应用。严禁以其他方式对这些资源进行复制或展示。您无权使用任何其他 TI 知识产权或任何第三方知识产权。您应全额赔偿因在这些资源的使用中对 TI 及其代表造成的任何索赔、损害、成本、损失和债务，TI 对此概不负责。

TI 提供的产品受 [TI 的销售条款](#) 或 [ti.com](#) 上其他适用条款/TI 产品随附的其他适用条款的约束。TI 提供这些资源并不会扩展或以其他方式更改 TI 针对 TI 产品发布的适用的担保或担保免责声明。

TI 反对并拒绝您可能提出的任何其他或不同的条款。

邮寄地址：Texas Instruments, Post Office Box 655303, Dallas, Texas 75265
版权所有 © 2025，德州仪器 (TI) 公司