

ULTRA LOW-POWER, 10 mA, LDO LINEAR REGULATORS WITH POWER GOOD OUTPUT

FEATURES

- **Controlled Baseline**
 - One Assembly Site
 - One Test Site
 - One Fabrication Site
- **Extended Temperature Performance of –55°C to 125°C**
- **Enhanced Diminishing Manufacturing Sources (DMS) Support**
- **Enhanced Product-Change Notification**
- **Qualification Pedigree⁽¹⁾**
- **10 mA Low-Dropout Regulator**
- **Ultralow 1.2 μ A Quiescent Current at 10 mA**
- **5-Pin SC70/SOT-323 (DCK) Package**
- **Integrated Power Good Output**
- **Stable With Any Capacitor (> 0.47 μ F)**
- **Dropout Voltage Typically 105 mV at 10 mA (TPS79733)**
- **Overcurrent Limitation**

(1) Component qualification in accordance with JEDEC and industry standards to ensure reliable operation over an extended temperature range. This includes, but is not limited to, Highly Accelerated Stress Test (HAST) or biased 85/85, temperature cycle, autoclave or unbiased HAST, electromigration, bond intermetallic life, and mold compound life. Such qualification testing should not be viewed as justifying use of this component beyond specified performance and environmental limits.

APPLICATIONS

- **Battery-Powered Microcontrollers and Microprocessors**

DESCRIPTION/ORDERING INFORMATION

The TPS797xx family of low-dropout (LDO) voltage regulators offers the benefits of low-dropout voltage and ultralow-power operation. The device is stable with any capacitor (> 0.47 μ F). Therefore, implementations of this device require little board space due to the miniaturized packaging and potentially small output capacitor. In addition, the family includes an integrated open drain active-high power good (PG) output. Intended for use in microcontroller based, battery-powered applications, the TPS797xx family's low dropout and ultralow-powered operation results in a significant increase in system battery operating life. The small packaging minimizes consumption of board space.

The device is enabled when the applied voltage exceeds the minimum input voltage. The usual PNP pass transistor has been replaced by a PMOS pass element. Because the PMOS pass element behaves as a low-value resistor, the dropout voltage is low, 125 mV (typ) at 10 mA of load current and is directly proportional to the load current. The quiescent current is ultralow (1.2 μ A typ) and is stable over the entire range of output load current (0 mA to 10 mA). When properly configured with a pullup resistor, the PG output can be used to implement a power-on reset or low battery indicator. The TPS797xx is offered in 1.8 V, 3 V, and 3.3 V fixed options.

ORDERING INFORMATION⁽¹⁾

T _A	VOLTAGE	PACKAGE ⁽²⁾	PART NUMBER	SYMBOL
–55°C to 125°C	1.8 V	SC70/SOT-323 (DCK)	TPS79718MDCKREP	CKW
	3 V		TPS79730MDCKREP	BUA
	3.3 V		TPS79733MDCKREP ⁽³⁾	TBD

(1) For the most current package and ordering information, see the Package Option Addendum at the end of this document, or see the TI website at www.ti.com.

(2) Package drawings, thermal data, and symbolization are available at www.ti.com/packaging.

(3) Product Preview. Parameters in electrical characteristics are subject to change.



Please be aware that an important notice concerning availability, standard warranty, and use in critical applications of Texas Instruments semiconductor products and disclaimers thereto appears at the end of this data sheet.

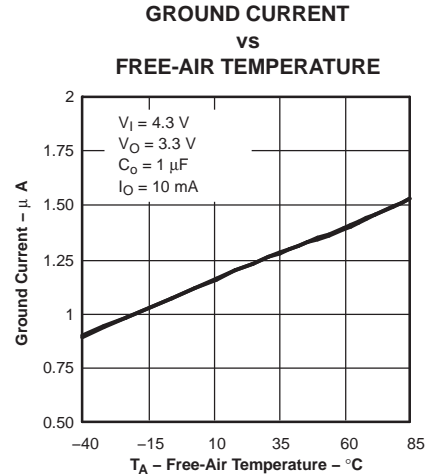
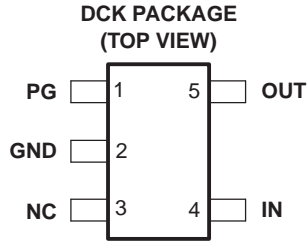

DEVICE INFORMATION

FUNCTIONAL BLOCK DIAGRAM

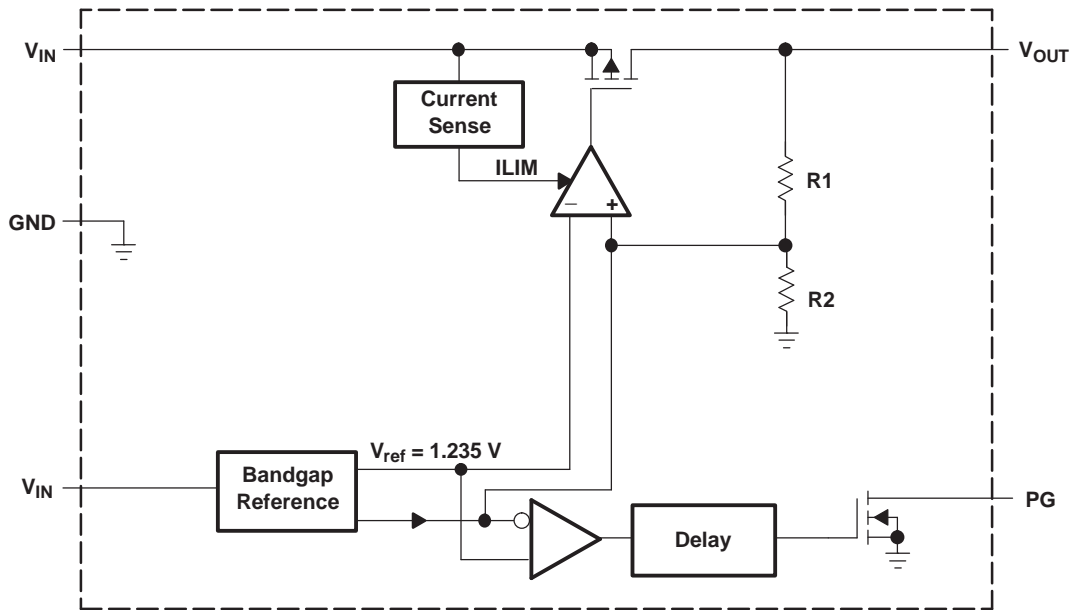

TERMINAL FUNCTIONS

TERMINAL		I/O	DESCRIPTION
NAME	NO.		
IN	4	I	The IN terminal is the power supply input to the device.
GND	2		Ground
NC	3		No connection
OUT	5	O	The OUT terminal provides the regulated output voltage of the device.
PG	1	O	The PG terminal for the fixed voltage option devices is an open-drain active-high output that indicates the status of V_O (output of the LDO). When V_O exceeds approximately 90% of the regulated voltage, PG goes to a high impedance state. It goes to a low-impedance state when V_O falls below approximately 90% (i.e. overload condition) of the regulated voltage. The open drain output of the PG terminal requires a pullup resistor.

ABSOLUTE MAXIMUM RATINGS⁽¹⁾

over operating free-air temperature range (unless otherwise noted)

	VALUE	UNIT
Input voltage range ⁽²⁾	0.3 to 6	V
Maximum dc output voltage	4.9	V
Peak output current	Internally limited	
ESD rating, HBM	3	kV
ESD rating, CDM	1	kV
Continuous total power dissipation	See Dissipation Rating Table	
T _J Operating junction temperature range	–55 to 145	°C
T _A Operating ambient temperature range	–55 to 125	°C
T _{stg} Storage temperature range	–65 to 150	°C

- (1) Stresses beyond those listed under "absolute maximum ratings" may cause permanent damage to the device. These are stress ratings only, and functional operation of the device at these or any other conditions beyond those indicated under "recommended operating conditions" is not implied. Exposure to absolute-maximum-rated conditions for extended periods may affect device reliability.
- (2) All voltage values are with respect to network ground terminal.

DISSIPATION RATINGS

BOARD	PACKAGE	R _{θJC} (°C/W)	R _{θJA} (°C/W)	DERATING FACTOR ABOVE T _A = 25°C	T _A ≥ 25°C POWER RATING	T _A = 70°C POWER RATING	T _A = 85°C POWER RATING	T _A = 125°C POWER RATING
Low K	DCK	165.39	396.24	2.52 mW/°C	252 mW	139 mW	101 mW	0 W
High K	DCK	165.39	314.74	3.18 mW/°C	318 mW	175 mW	127 mW	127 mW

ELECTRICAL CHARACTERISTICS

over operating free-air temperature range (unless otherwise noted)

PARAMETER		TEST CONDITIONS	MIN	TYP	MAX	UNIT	
V _I	Input voltage ⁽¹⁾	I _O = 3 mA	1.8		5.5	V	
		I _O = 10 mA	2		5.5	V	
I _O	Continuous output current ⁽²⁾		0		10	mA	
T _A	Operating ambient temperature		-55		125	°C	
Output voltage (1mA to 10mA load) ⁽³⁾	TPS79718	T _A = 25°C, 2.8 V < V _I < 5.5 V		1.8		V	
		T _J = -55°C to 125°C, 2.8 V < V _I < 5.5 V	1.705		1.895		
	TPS79730	T _A = 25°C, 4 V < V _I < 5.5 V			3		V
		T _J = -55°C to 125°C, 4 V < V _I < 5.5 V	2.88			3.12	
	TPS79733	T _A = 25°C, 4.3 V < V _I < 5.5 V			3.3		V
		T _J = -55°C to 125°C, 4.3 V < V _I < 5.5 V	3.168			3.432	
Quiescent current (GND current) ⁽³⁾		T _A = 25°C, 0 mA < I _O < 10 mA		1.2		μA	
		T _J = -55°C to 125°C, I _O = 10 mA			5		
Load regulation		T _A = 25°C, I _O = 1 mA to 10 mA		17		mV	
Output voltage line regulation (ΔV _{out} /ΔV _{in}) ⁽³⁾		V _O + 1 V < V _I ≤ 5.5 V, T _A = 25°C		0.15		%V	
		V _O + 1 V < V _I ≤ 5.5 V, T _J = -55°C to 125°C					0.8
Output noise voltage (TPS79718)		BW = 200 Hz to 100 kHz, C _O = 10 mF, I _O = 10 mA, T _A = 25°C		600		μV _{RMS}	
Output current limit		V _O = 0 V, See Note 4		190	300	mA	
Power supply ripple rejection (TPS79718)		f = 100 Hz, C _O = 10 mF, I _O = 10 mA, T _A = 25°C		50		dB	
Dropout voltage ⁽⁴⁾		TPS79730	I _O = 10 mA, T _A = 25°C		125	mV	
			I _O = 10 mA, T _A = -55°C to 125°C				400
		TPS79733	I _O = 10 mA, T _A = 25°C		105		
			I _O = 10 mA, T _A = -55°C to 125°C				400
Minimum input voltage for valid PG		I _(PG) = 100 μA, V _(PG) ≥ 0.8 V		1.2		V	
PG trip threshold voltage		V _O decreasing		90		%V _O	
PG output low voltage		V _I = 1.4 V, I _(PG) = 100 μA		0.14	0.4	V	
PG leakage current		V _(PG) = 5 V		0.1		nA	

- (1) To calculate the minimum input voltage for your maximum output current, use the following formula: V_I(min) = V_O(max) + V_{DO} (max load)
- (2) Continuous output current is limited by internal protection circuitry, but it is not recommended that the device operate under conditions beyond those specified in this table for extended periods of time.
- (3) The minimum IN operating voltage is 1.8 V or V_O (typ) + 1 V, whichever is greater. The maximum IN voltage is 5.5 V. There is no minimum output current requirement and the maximum output current is 10 mA.
- (4) IN voltage equals V_O(typ) - 100 mV; The TPS79730 input voltage is set to 2.9 V and the TPS79733 input voltage is set to 3.2 V. The TPS79718 dropout voltage is limited by input voltage range limitations.

TPS797xx PG TIMING DIAGRAM

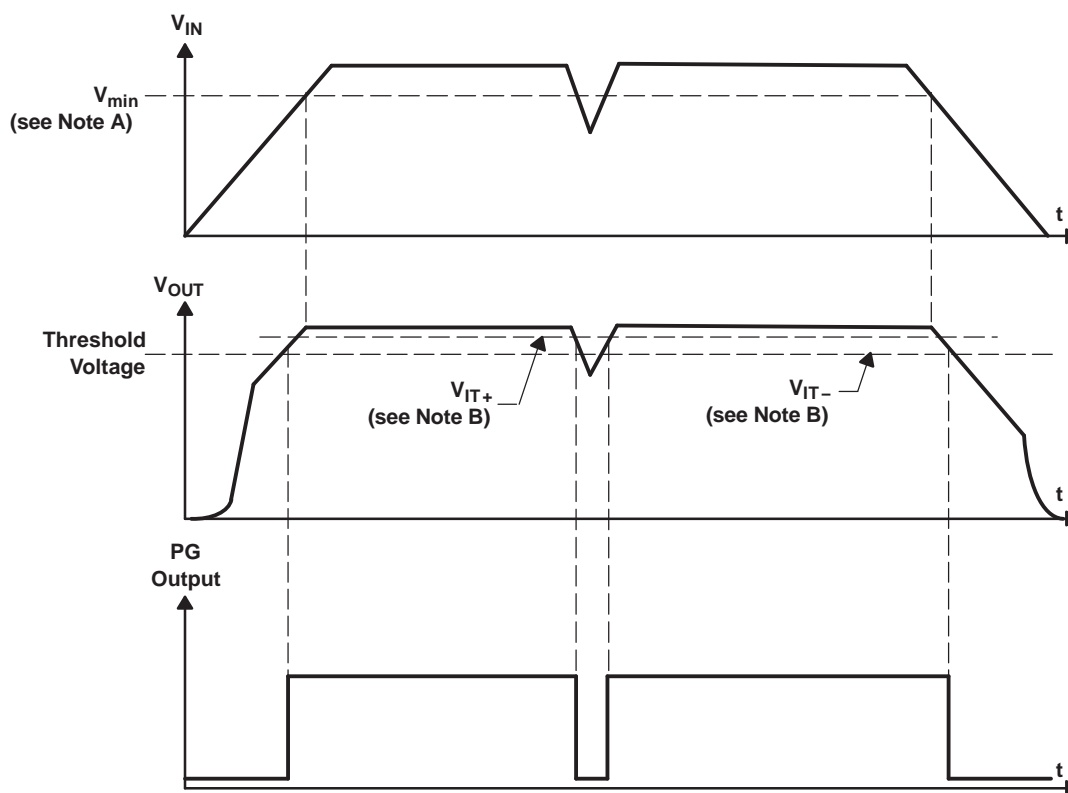

- A. $V_{min} = V_{OUT} + V_{DO}$
- B. The PG trip voltage is typically 10% lower than the output voltage ($90\%V_O$). V_{IT-} to V_{IT+} is the hysteresis voltage.

TYPICAL CHARACTERISTICS

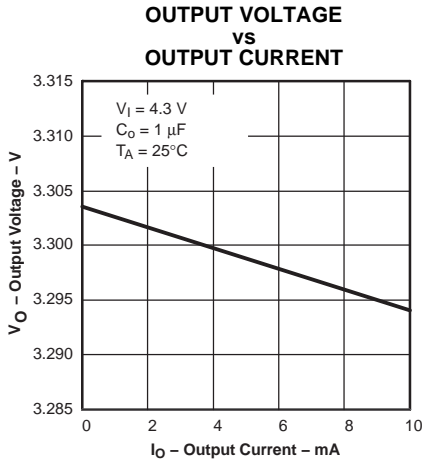

Figure 1.

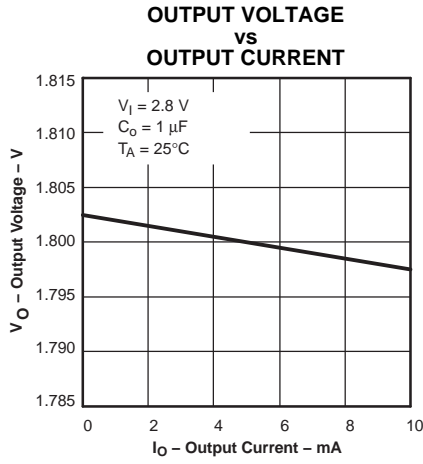

Figure 2.

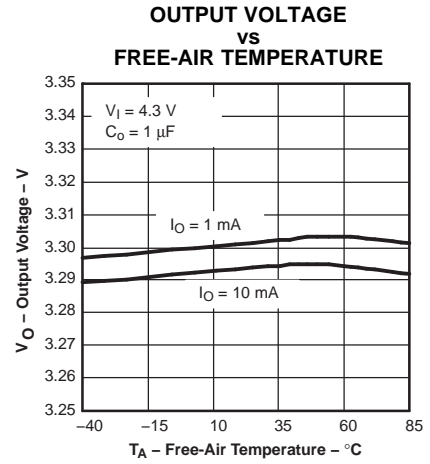

Figure 3.

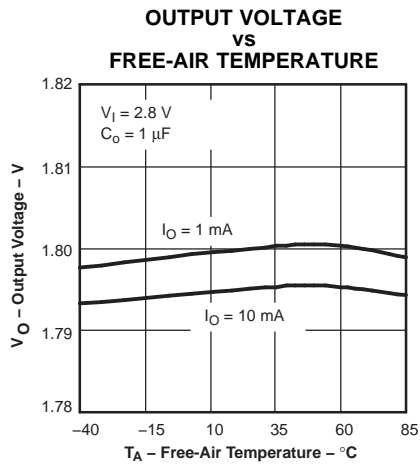

Figure 4.

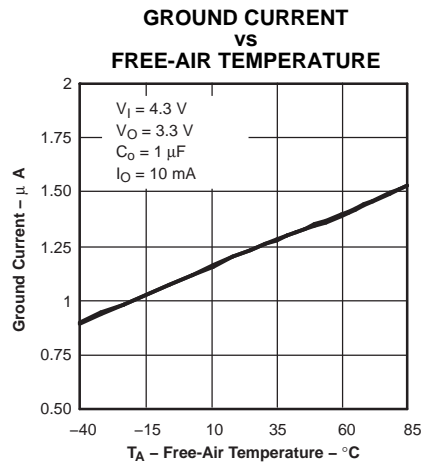

Figure 5.

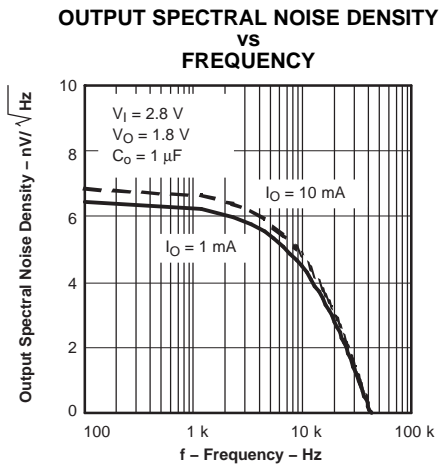

Figure 6.

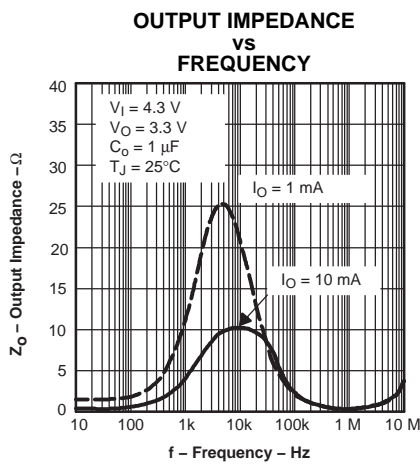

Figure 7.

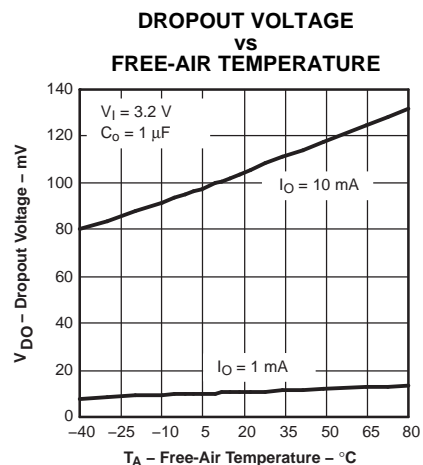

Figure 8.

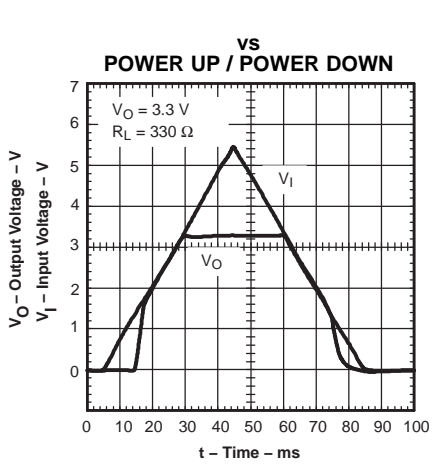

Figure 9.

TYPICAL CHARACTERISTICS (continued)

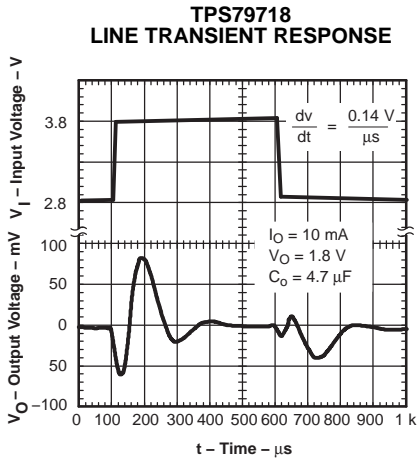

Figure 10.

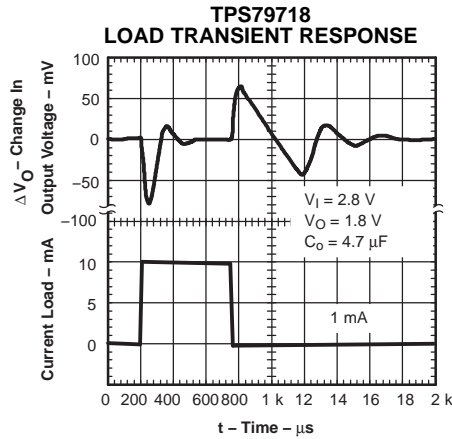

Figure 11.

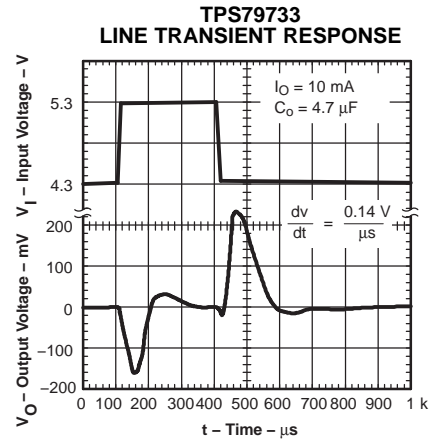

Figure 12.

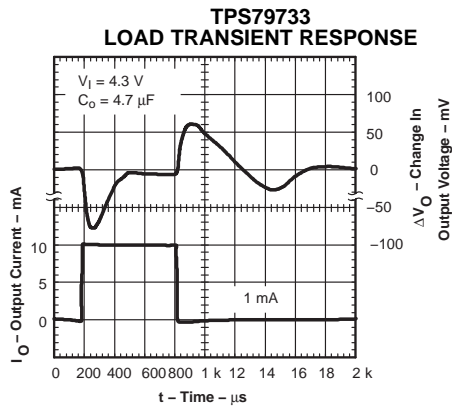

Figure 13.

APPLICATION INFORMATION

The TPS797xx family of low-dropout (LDO) regulators has been optimized for use in micropower applications. The devices feature extremely low dropout voltages and ultralow quiescent current (1.2 μA typ).

A typical application circuit is shown in [Figure 14](#).

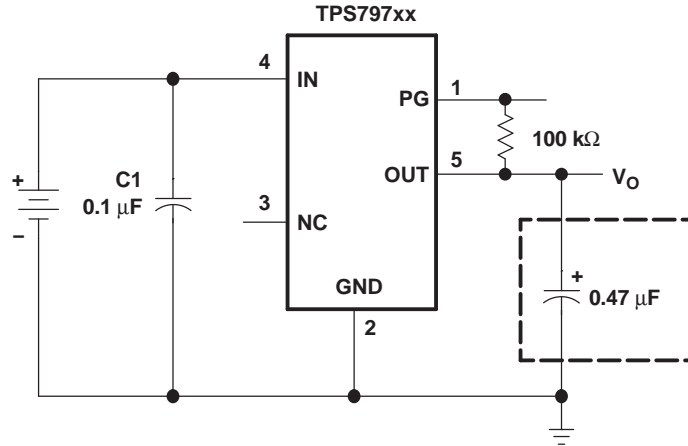

Figure 14. Typical Application Circuit

External Capacitor Requirements

Although not required, a 0.1 μF or larger input bypass capacitor, connected between IN and GND and located close to the TPS797xx, is recommended, especially when a highly resistive power supply is powering the LDO in addition to other devices.

Like all low-dropout regulators, the TPS797xx requires an output capacitor connected between OUT and GND to stabilize the internal control loop. The minimum recommended capacitance is 0.47 μF . Any 0.47 μF capacitor is suitable. Capacitor values larger than 0.47 μF are acceptable.

Power Dissipation and Junction Temperature

Specified regulator operation is assured to a junction temperature of 125°C; restrict the maximum junction temperature to 125°C under normal operating conditions. This restriction limits the power dissipation the regulator can handle in any given application. To ensure the junction temperature is within acceptable limits, calculate the maximum allowable dissipation, $P_{D(max)}$, and the actual dissipation, P_D , which must be less than or equal to $P_{D(max)}$.

$$P_{D(max)} = \frac{T_{Jmax} - T_A}{R_{\theta JA}}$$

The maximum-power-dissipation limit is determined using the following equation:

Where:

T_{Jmax} is the maximum allowable junction temperature.

$R_{\theta JA}$ is the thermal resistance junction-to-ambient for the package (see the Power Dissipation Rating Table).

T_A is the ambient temperature.

The regulator dissipation is calculated using:

$$P_D = (V_I - V_O) \times I_O$$

Power dissipation resulting from quiescent current is negligible. Excessive power dissipation triggers the thermal protection circuit.

Regulator Protection

The TPS797xx PMOS-pass transistor has a built-in back diode that conducts reverse current when the input voltage drops below the output voltage (e.g., during power down). Current is conducted from the output to the input and is not internally limited. If extended reverse voltage operation is anticipated, external limiting might be appropriate.

The TPS797xx features internal current limiting. During normal operation, the TPS797xx limits output current to approximately 190 mA. When current limiting engages, the output voltage scales back linearly until the overcurrent condition ends. Take care not to exceed the power dissipation ratings of the package.

Microcontroller Application

One application for which this device is particularly suited is providing a regulated input voltage and power good (PG) supervisory signal to low-power devices such as mixed-signal microcontrollers. The quiescent or ground current of the TPS797xx family is typically 1.2 μA even at full load; therefore, the reduction in battery life by including the TPS797xx in the system is negligible. The primary benefits of using the TPS797xx to power low power digital devices include:

- Regulated output voltage that protects the device from battery droop and noise on the line (e.g., switch bounce)
- Smooth, monotonic power up
- PG signal for controlled device RESET
- Potential to use an existing 5-V power rail to power a 3.3 V or lower device
- Potential to provide separate digital and analog power and ground supplies for a system with only one power source

Figure 15 shows an application in which the TPS79718 is used to power Texas Instruments MSP430 mixed signal microcontroller.

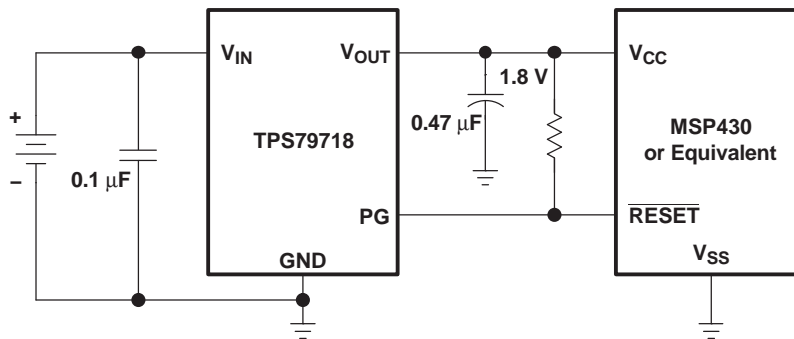

Figure 15. MSP430 Microcontroller Powered by the TPS79718 Regulator

Minimal board space is needed to accommodate the DCK (SC70/SOT-323) packaged TPS79718, the 0.1 μF output capacitor, the 0.47 μF input capacitor, and the pullup resistor on the PG pin.

PACKAGING INFORMATION

Orderable part number	Status (1)	Material type (2)	Package Pins	Package qty Carrier	RoHS (3)	Lead finish/ Ball material (4)	MSL rating/ Peak reflow (5)	Op temp (°C)	Part marking (6)
TPS79718MDCKREP	Active	Production	SC70 (DCK) 5	3000 LARGE T&R	Yes	NIPDAUAG	Level-1-260C-UNLIM	-55 to 125	CKW
TPS79718MDCKREP.A	Active	Production	SC70 (DCK) 5	3000 LARGE T&R	Yes	NIPDAUAG	Level-1-260C-UNLIM	-55 to 125	CKW
TPS79730MDCKREP	Active	Production	SC70 (DCK) 5	3000 LARGE T&R	Yes	NIPDAUAG	Level-1-260C-UNLIM	-55 to 125	BUA
TPS79730MDCKREP.A	Active	Production	SC70 (DCK) 5	3000 LARGE T&R	Yes	NIPDAUAG	Level-1-260C-UNLIM	-55 to 125	BUA
V62/06673-01XE	Active	Production	SC70 (DCK) 5	3000 LARGE T&R	Yes	NIPDAUAG	Level-1-260C-UNLIM	-55 to 125	CKW
V62/06673-02XE	Active	Production	SC70 (DCK) 5	3000 LARGE T&R	Yes	NIPDAUAG	Level-1-260C-UNLIM	-55 to 125	BUA

(1) **Status:** For more details on status, see our [product life cycle](#).

(2) **Material type:** When designated, preproduction parts are prototypes/experimental devices, and are not yet approved or released for full production. Testing and final process, including without limitation quality assurance, reliability performance testing, and/or process qualification, may not yet be complete, and this item is subject to further changes or possible discontinuation. If available for ordering, purchases will be subject to an additional waiver at checkout, and are intended for early internal evaluation purposes only. These items are sold without warranties of any kind.

(3) **RoHS values:** Yes, No, RoHS Exempt. See the [TI RoHS Statement](#) for additional information and value definition.

(4) **Lead finish/Ball material:** Parts may have multiple material finish options. Finish options are separated by a vertical ruled line. Lead finish/Ball material values may wrap to two lines if the finish value exceeds the maximum column width.

(5) **MSL rating/Peak reflow:** The moisture sensitivity level ratings and peak solder (reflow) temperatures. In the event that a part has multiple moisture sensitivity ratings, only the lowest level per JEDEC standards is shown. Refer to the shipping label for the actual reflow temperature that will be used to mount the part to the printed circuit board.

(6) **Part marking:** There may be an additional marking, which relates to the logo, the lot trace code information, or the environmental category of the part.

Multiple part markings will be inside parentheses. Only one part marking contained in parentheses and separated by a "~" will appear on a part. If a line is indented then it is a continuation of the previous line and the two combined represent the entire part marking for that device.

Important Information and Disclaimer: The information provided on this page represents TI's knowledge and belief as of the date that it is provided. TI bases its knowledge and belief on information provided by third parties, and makes no representation or warranty as to the accuracy of such information. Efforts are underway to better integrate information from third parties. TI has taken and continues to take reasonable steps to provide representative and accurate information but may not have conducted destructive testing or chemical analysis on incoming materials and chemicals. TI and TI suppliers consider certain information to be proprietary, and thus CAS numbers and other limited information may not be available for release.

In no event shall TI's liability arising out of such information exceed the total purchase price of the TI part(s) at issue in this document sold by TI to Customer on an annual basis.

TAPE AND REEL INFORMATION

QUADRANT ASSIGNMENTS FOR PIN 1 ORIENTATION IN TAPE

*All dimensions are nominal

Device	Package Type	Package Drawing	Pins	SPQ	Reel Diameter (mm)	Reel Width W1 (mm)	A0 (mm)	B0 (mm)	K0 (mm)	P1 (mm)	W (mm)	Pin1 Quadrant
TPS79718MDCKREP	SC70	DCK	5	3000	180.0	8.4	2.41	2.41	1.2	4.0	8.0	Q3
TPS79730MDCKREP	SC70	DCK	5	3000	180.0	8.4	2.41	2.41	1.2	4.0	8.0	Q3

TAPE AND REEL BOX DIMENSIONS

*All dimensions are nominal

Device	Package Type	Package Drawing	Pins	SPQ	Length (mm)	Width (mm)	Height (mm)
TPS79718MDCKREP	SC70	DCK	5	3000	202.0	201.0	28.0
TPS79730MDCKREP	SC70	DCK	5	3000	202.0	201.0	28.0

DCK0005A



PACKAGE OUTLINE

SOT - 1.1 max height

SMALL OUTLINE TRANSISTOR

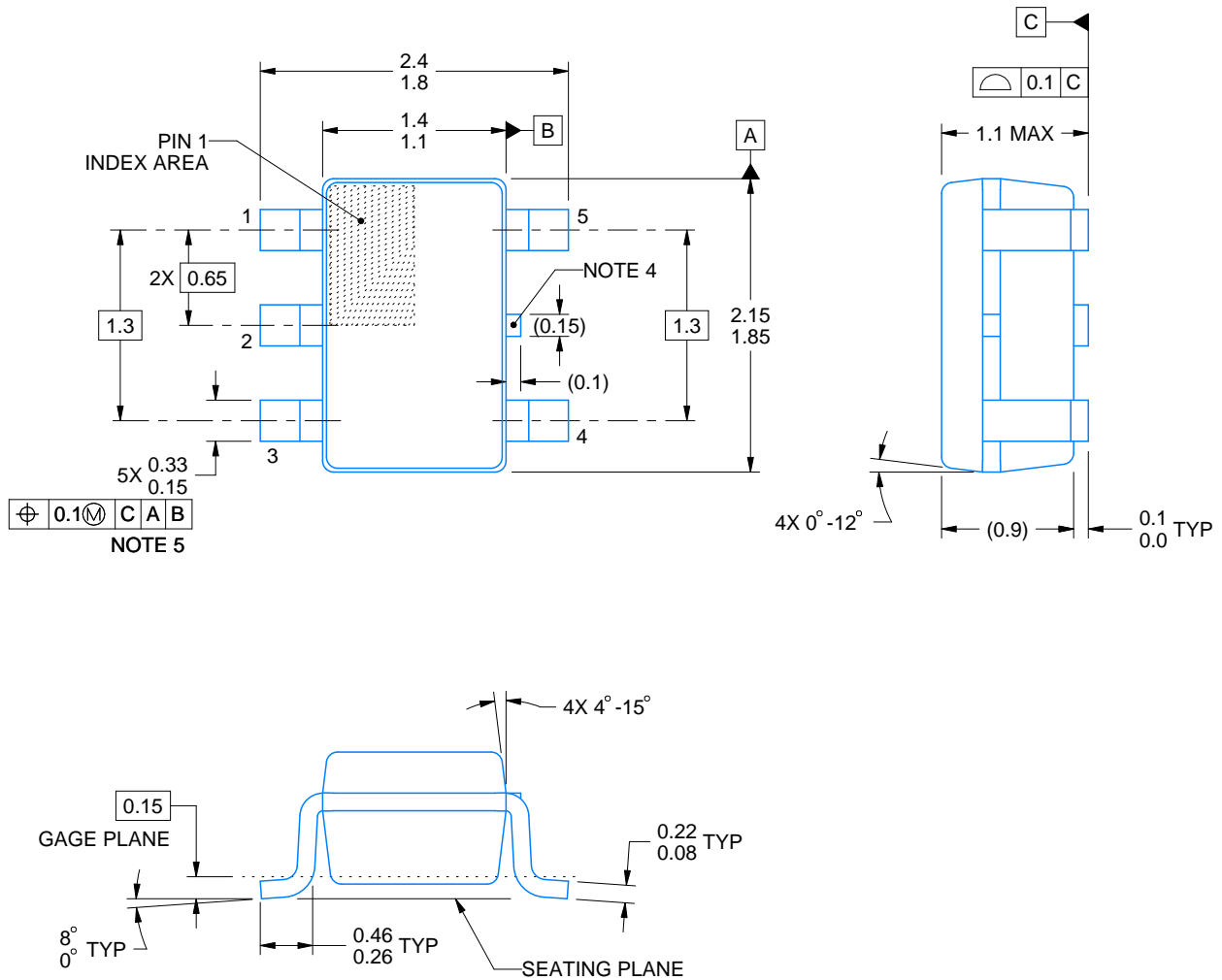

4214834/G 11/2024

NOTES:

1. All linear dimensions are in millimeters. Any dimensions in parenthesis are for reference only. Dimensioning and tolerancing per ASME Y14.5M.
2. This drawing is subject to change without notice.
3. Reference JEDEC MO-203.
4. Support pin may differ or may not be present.
5. Lead width does not comply with JEDEC.
6. Body dimensions do not include mold flash, protrusions, or gate burrs. Mold flash, protrusions, or gate burrs shall not exceed 0.25mm per side

EXAMPLE BOARD LAYOUT

DCK0005A

SOT - 1.1 max height

SMALL OUTLINE TRANSISTOR



LAND PATTERN EXAMPLE
EXPOSED METAL SHOWN
SCALE:18X

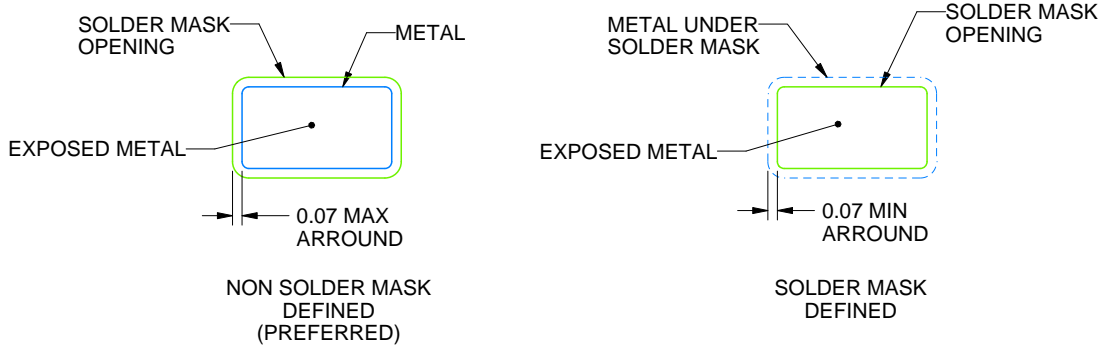

SOLDER MASK DETAILS

4214834/G 11/2024

NOTES: (continued)

7. Publication IPC-7351 may have alternate designs.
8. Solder mask tolerances between and around signal pads can vary based on board fabrication site.

EXAMPLE STENCIL DESIGN

DCK0005A

SOT - 1.1 max height

SMALL OUTLINE TRANSISTOR



SOLDER PASTE EXAMPLE
BASED ON 0.125 THICK STENCIL
SCALE: 18X

4214834/G 11/2024

NOTES: (continued)

9. Laser cutting apertures with trapezoidal walls and rounded corners may offer better paste release. IPC-7525 may have alternate design recommendations.
10. Board assembly site may have different recommendations for stencil design.

IMPORTANT NOTICE AND DISCLAIMER

TI PROVIDES TECHNICAL AND RELIABILITY DATA (INCLUDING DATA SHEETS), DESIGN RESOURCES (INCLUDING REFERENCE DESIGNS), APPLICATION OR OTHER DESIGN ADVICE, WEB TOOLS, SAFETY INFORMATION, AND OTHER RESOURCES "AS IS" AND WITH ALL FAULTS, AND DISCLAIMS ALL WARRANTIES, EXPRESS AND IMPLIED, INCLUDING WITHOUT LIMITATION ANY IMPLIED WARRANTIES OF MERCHANTABILITY, FITNESS FOR A PARTICULAR PURPOSE OR NON-INFRINGEMENT OF THIRD PARTY INTELLECTUAL PROPERTY RIGHTS.

These resources are intended for skilled developers designing with TI products. You are solely responsible for (1) selecting the appropriate TI products for your application, (2) designing, validating and testing your application, and (3) ensuring your application meets applicable standards, and any other safety, security, regulatory or other requirements.

These resources are subject to change without notice. TI grants you permission to use these resources only for development of an application that uses the TI products described in the resource. Other reproduction and display of these resources is prohibited. No license is granted to any other TI intellectual property right or to any third party intellectual property right. TI disclaims responsibility for, and you will fully indemnify TI and its representatives against, any claims, damages, costs, losses, and liabilities arising out of your use of these resources.

TI's products are provided subject to [TI's Terms of Sale](#) or other applicable terms available either on [ti.com](https://www.ti.com) or provided in conjunction with such TI products. TI's provision of these resources does not expand or otherwise alter TI's applicable warranties or warranty disclaimers for TI products.

TI objects to and rejects any additional or different terms you may have proposed.

Mailing Address: Texas Instruments, Post Office Box 655303, Dallas, Texas 75265

Copyright © 2025, Texas Instruments Incorporated