

CSD19532KTT 100V N 沟道 NexFET™ 功率 MOSFET

1 特性

- 超低 Q_g 和 Q_{gd}
- 低热阻
- 雪崩级
- 无铅引脚镀层
- 符合 RoHS 环保标准
- 无卤素
- D²PAK 塑料封装

2 应用

- 次级侧同步整流器
- 热插拔
- 电机控制

3 说明

这款 100V、4.6mΩ、D²PAK (TO-263) NexFET™ 功率 MOSFET 被设计成在功率转换应用中大大降低损耗。

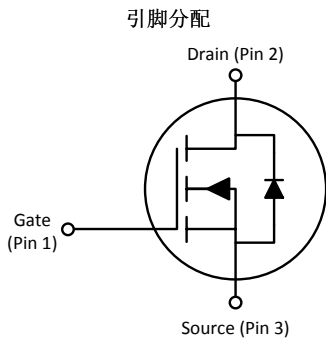

$R_{DS(on)}$ 与 V_{GS} 间的关系

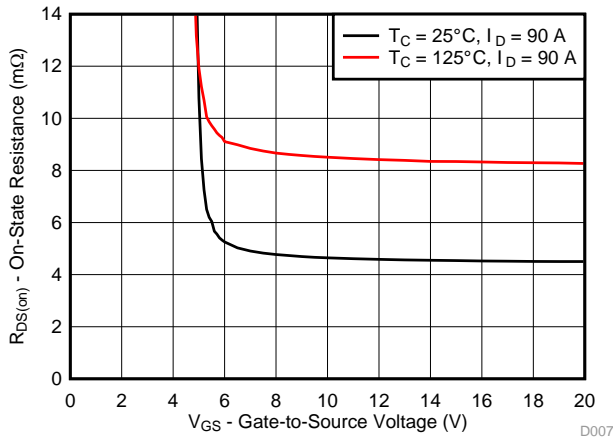

产品概要

$T_A = 25^\circ\text{C}$		典型值		单位
V_{DS}	漏源电压	100		V
Q_g	栅极电荷总量 (10V)	44		nC
Q_{gd}	栅极电荷 栅极到漏极	5.6		nC
$R_{DS(on)}$	漏源导通电阻	$V_{GS} = 6\text{V}$	5.3	mΩ
		$V_{GS} = 10\text{V}$	4.6	mΩ
$V_{GS(th)}$	阈值电压	2.6		V

订购信息⁽¹⁾

器件	数量	包装介质	封装	运输
CSD19532KTT	500	13 英寸卷带	D ² PAK 塑料封装	卷带封装
CSD19532KTTT	50			

(1) 要了解所有可用封装，请见数据表末尾的可订购产品附录。

绝对最大额定值

$T_A = 25^\circ\text{C}$		值	单位
V_{DS}	漏源电压	100	V
V_{GS}	栅源电压	± 20	V
I_D	持续漏极电流 (受封装限制)	200	A
	持续漏极电流 (受芯片限制), $T_C = 25^\circ\text{C}$ 时测得	136	
	持续漏极电流 (受芯片限制), $T_C = 100^\circ\text{C}$ 时测得	98	
I_{DM}	脉冲漏极电流 ⁽¹⁾	400	A
P_D	功率耗散	250	W
T_J, T_{stg}	运行结温和储存温度范围	-55 至 175	$^\circ\text{C}$
E_{AS}	雪崩能量, 单一脉冲 $I_D = 72\text{A}, L = 0.1\text{mH}, R_G = 25\Omega$	259	mJ

(1) 最大 $R_{\theta JC} = 0.6^\circ\text{C/W}$, 脉冲持续时间 $\leq 100\mu\text{s}$, 占空比 $\leq 1\%$

栅极电荷

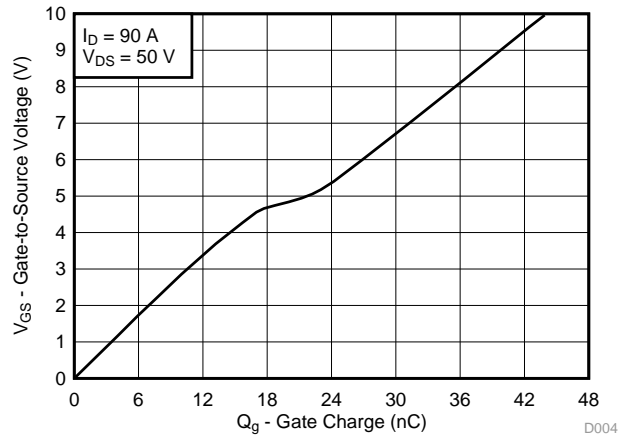

目录

1	特性	1	6	器件和文档支持	7
2	应用	1	6.1	社区资源	7
3	说明	1	6.2	商标	7
4	修订历史记录	2	6.3	静电放电警告	7
5	Specifications	3	6.4	Glossary	7
5.1	Electrical Characteristics	3	7	机械、封装和可订购信息	8
5.2	Thermal Information	3	7.1	KTT 封装尺寸	8
5.3	Typical MOSFET Characteristics	4	7.2	推荐的 PCB 布局	9
			7.3	建议模板开口（模板厚度为 0.125mm）	9

4 修订历史记录

日期	修订版本	注释
2015 年 10 月	*	最初发布。

5 Specifications

5.1 Electrical Characteristics

($T_A = 25^\circ\text{C}$ unless otherwise stated)

PARAMETER		TEST CONDITIONS	MIN	TYP	MAX	UNIT
STATIC CHARACTERISTICS						
V_{DSS}	Drain-to-source voltage	$V_{GS} = 0\text{ V}, I_D = 250\ \mu\text{A}$	100			V
I_{DSS}	Drain-to-source leakage current	$V_{GS} = 0\text{ V}, V_{DS} = 80\text{ V}$			1	μA
I_{GSS}	Gate-to-source leakage current	$V_{DS} = 0\text{ V}, V_{GS} = 20\text{ V}$			100	nA
$V_{GS(th)}$	Gate-to-source threshold voltage	$V_{DS} = V_{GS}, I_D = 250\ \mu\text{A}$	2.2	2.6	3.2	V
$R_{DS(on)}$	Drain-to-source on resistance	$V_{GS} = 6\text{ V}, I_D = 90\text{ A}$		5.3	6.6	m Ω
		$V_{GS} = 10\text{ V}, I_D = 90\text{ A}$		4.6	5.6	m Ω
g_{fs}	Transconductance	$V_{DS} = 10\text{ V}, I_D = 90\text{ A}$		113		S
DYNAMIC CHARACTERISTICS						
C_{iss}	Input capacitance	$V_{GS} = 0\text{ V}, V_{DS} = 50\text{ V}, f = 1\text{ MHz}$		3890	5060	pF
C_{oss}	Output capacitance			674	876	pF
C_{rss}	Reverse transfer capacitance			14	18	pF
R_G	Series gate resistance			1.3	2.6	Ω
Q_g	Gate charge total (10 V)	$V_{DS} = 50\text{ V}, I_D = 90\text{ A}$		44	57	nC
Q_{gd}	Gate charge gate to drain			5.6		nC
Q_{gs}	Gate charge gate to source			17		nC
$Q_{g(th)}$	Gate charge at V_{th}			9.6		nC
Q_{oss}	Output charge	$V_{DS} = 50\text{ V}, V_{GS} = 0\text{ V}$		124		nC
$t_{d(on)}$	Turn on delay time	$V_{DS} = 50\text{ V}, V_{GS} = 10\text{ V},$ $I_{DS} = 90\text{ A}, R_G = 0\ \Omega$		9		ns
t_r	Rise time			3		ns
$t_{d(off)}$	Turn off delay time			14		ns
t_f	Fall time			2		ns
DIODE CHARACTERISTICS						
V_{SD}	Diode forward voltage	$I_{SD} = 90\text{ A}, V_{GS} = 0\text{ V}$		0.9	1.0	V
Q_{rr}	Reverse recovery charge	$V_{DS} = 50\text{ V}, I_F = 90\text{ A},$ $di/dt = 300\text{ A}/\mu\text{s}$		326		nC
t_{rr}	Reverse recovery time			74		ns

5.2 Thermal Information

($T_A = 25^\circ\text{C}$ unless otherwise stated)

THERMAL METRIC		MIN	TYP	MAX	UNIT
$R_{\theta JC}$	Junction-to-case thermal resistance			0.6	$^\circ\text{C}/\text{W}$
$R_{\theta JA}$	Junction-to-ambient thermal resistance			62	$^\circ\text{C}/\text{W}$

5.3 Typical MOSFET Characteristics

($T_A = 25^\circ\text{C}$ unless otherwise stated)

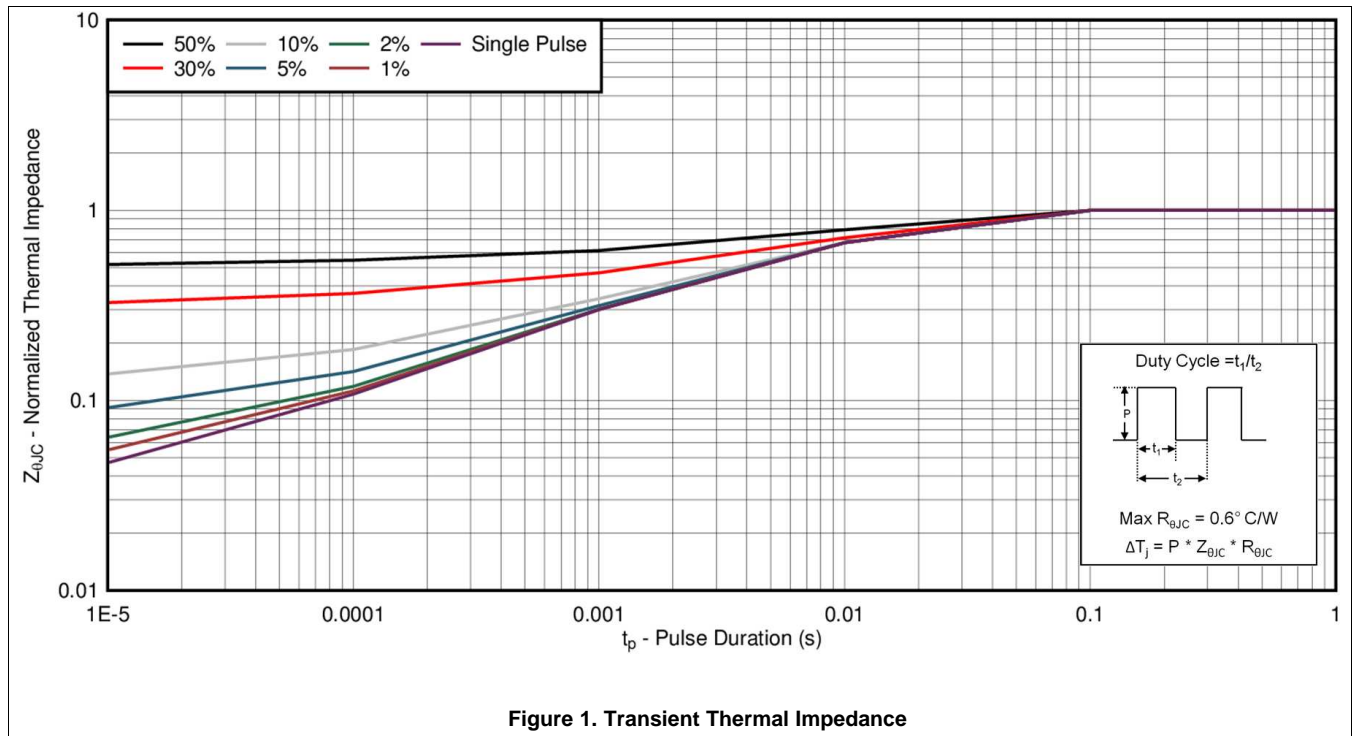

Figure 1. Transient Thermal Impedance

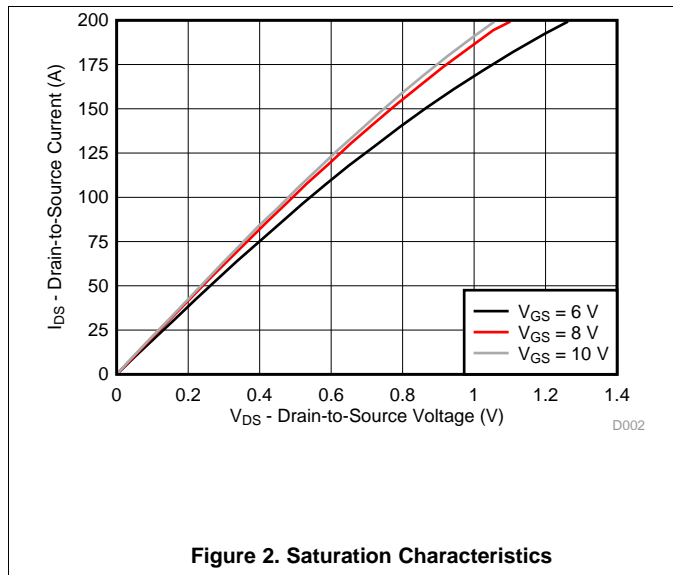

Figure 2. Saturation Characteristics

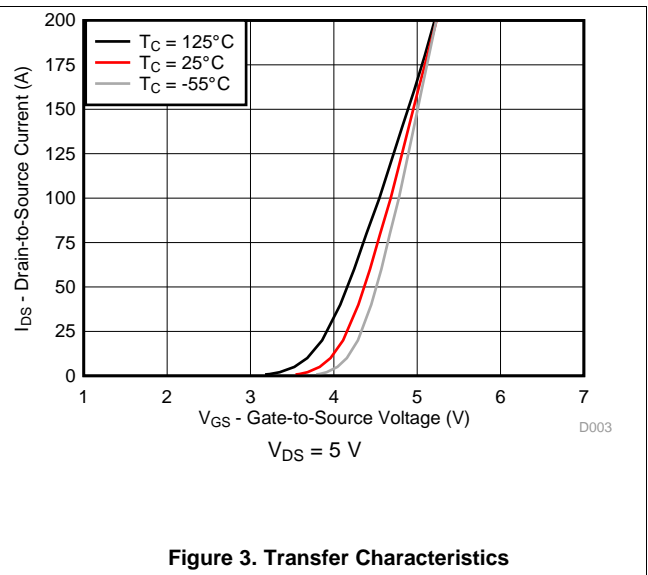

Figure 3. Transfer Characteristics

Typical MOSFET Characteristics (continued)

($T_A = 25^\circ\text{C}$ unless otherwise stated)

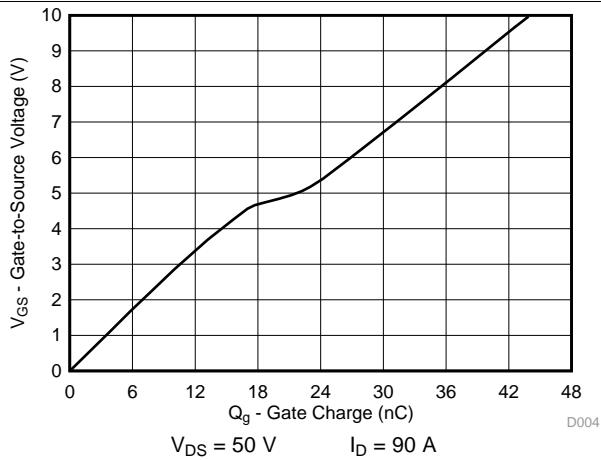

Figure 4. Gate Charge

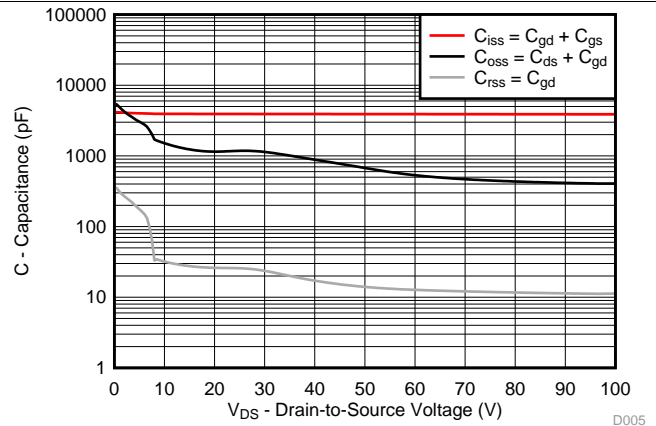

Figure 5. Capacitance

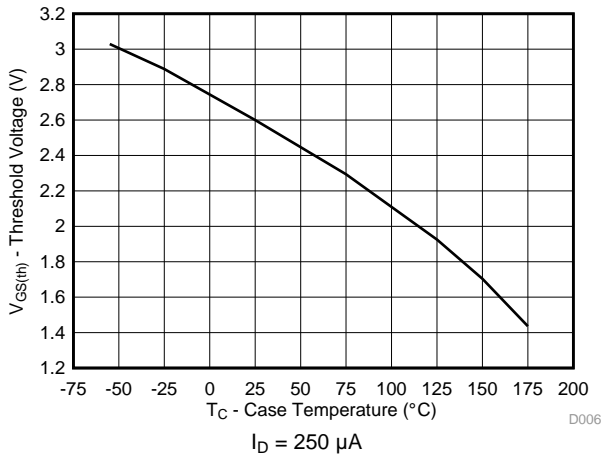

Figure 6. Threshold Voltage vs Temperature

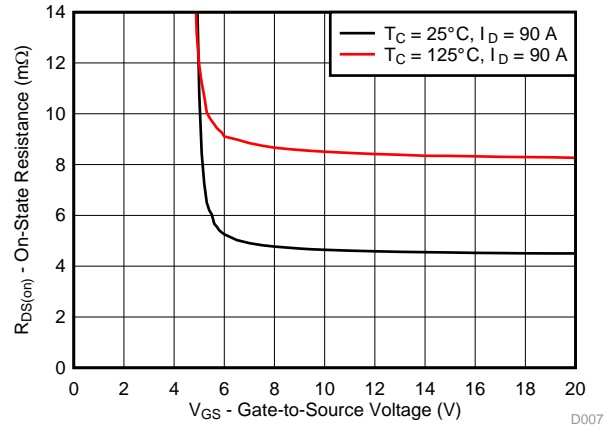

Figure 7. On-State Resistance vs Gate-to-Source Voltage

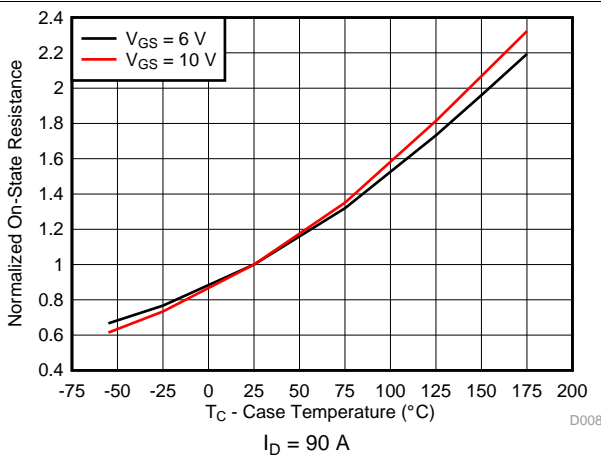

Figure 8. Normalized On-State Resistance vs Temperature

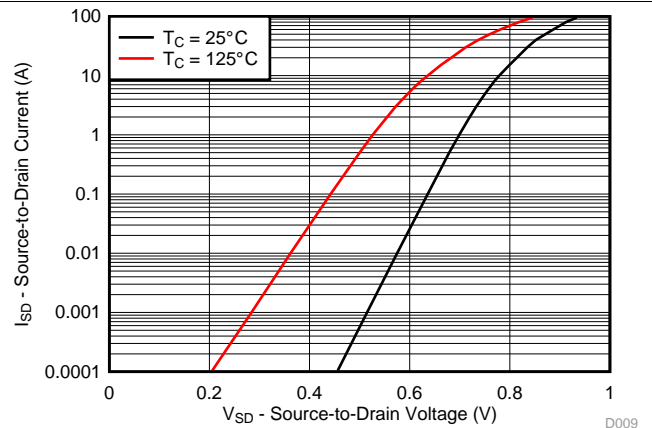

Figure 9. Typical Diode Forward Voltage

Typical MOSFET Characteristics (continued)

($T_A = 25^\circ\text{C}$ unless otherwise stated)

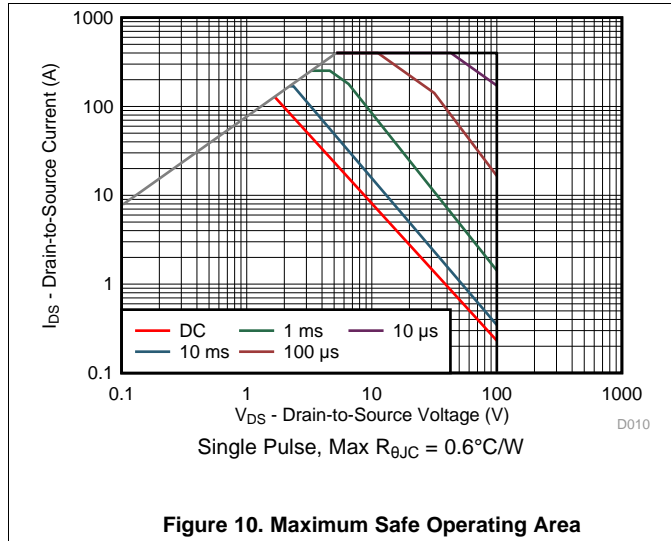

Figure 10. Maximum Safe Operating Area

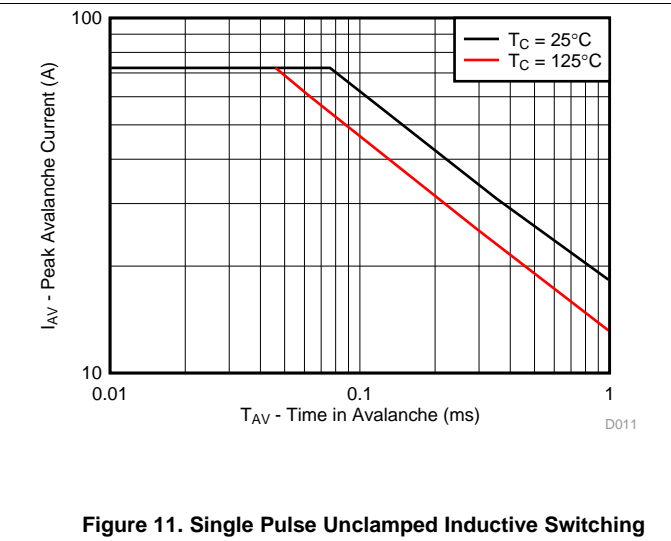

Figure 11. Single Pulse Unclamped Inductive Switching

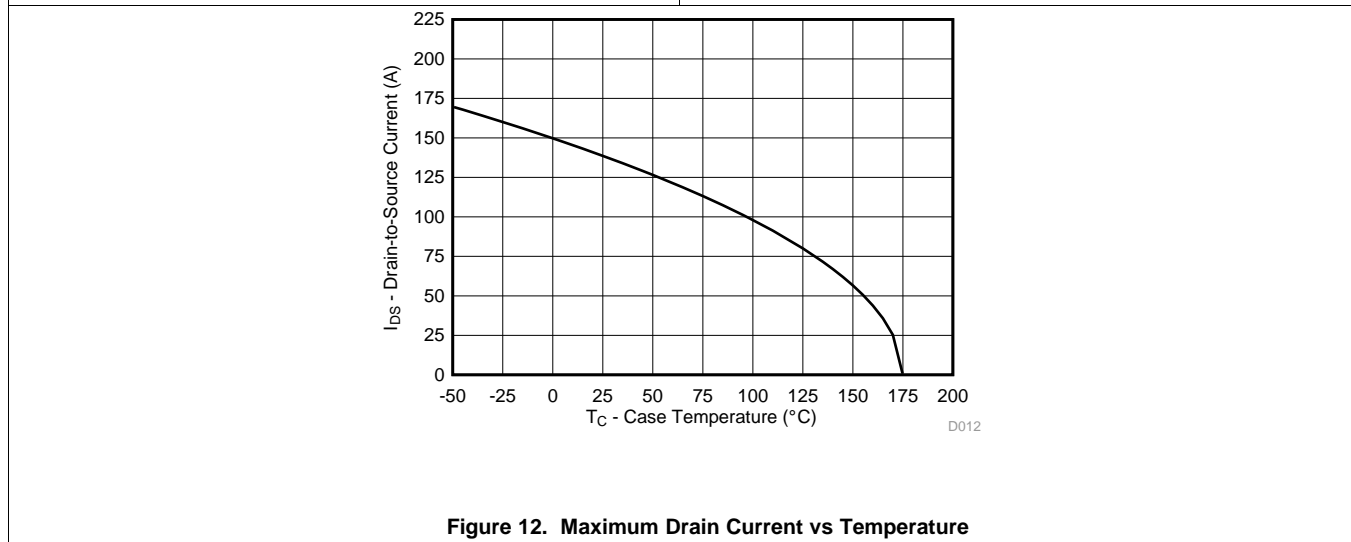

Figure 12. Maximum Drain Current vs Temperature

6 器件和文档支持

6.1 社区资源

The following links connect to TI community resources. Linked contents are provided "AS IS" by the respective contributors. They do not constitute TI specifications and do not necessarily reflect TI's views; see TI's [Terms of Use](#).

TI E2E™ Online Community *TI's Engineer-to-Engineer (E2E) Community*. Created to foster collaboration among engineers. At e2e.ti.com, you can ask questions, share knowledge, explore ideas and help solve problems with fellow engineers.

Design Support *TI's Design Support* Quickly find helpful E2E forums along with design support tools and contact information for technical support.

6.2 商标

NexFET, E2E are trademarks of Texas Instruments.

6.3 静电放电警告



这些装置包含有限的内置 ESD 保护。存储或装卸时，应将导线一起截短或将装置放置于导电泡棉中，以防止 MOS 门极遭受静电损伤。

6.4 Glossary

[SLYZ022](#) — *TI Glossary*.

This glossary lists and explains terms, acronyms, and definitions.

7 机械、封装和可订购信息

以下页中包括机械、封装和可订购信息。这些信息是针对指定器件可提供的最新数据。这些数据会在无通知且不对本文档进行修订的情况下发生改变。要获得这份数据表的浏览器版本，请查阅左侧的导航栏。

7.1 KTT 封装尺寸

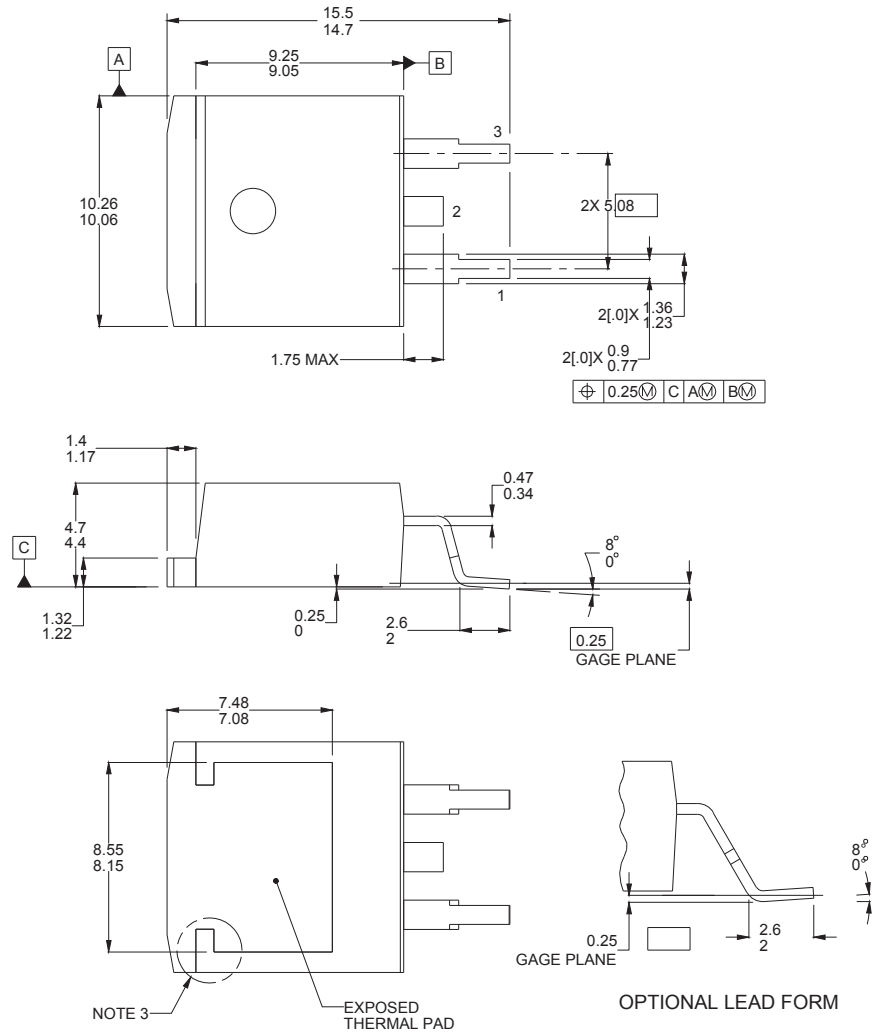

注:

1. 所有线性尺寸的单位均为毫米。括号中的任何尺寸仅供参考。尺寸和容限值遵循 ASME Y14.5M。
2. 本图纸如有变更，恕不通知。
3. 来自不同装配现场的产品可能不具备某些特性，形状也可能有所不同。

引脚配置

位置	名称
引脚 1	栅极
引脚 2 / 标签	漏极
引脚 3	源极

7.2 推荐的 PCB 布局

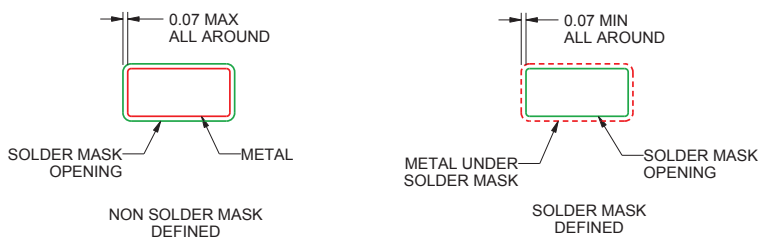
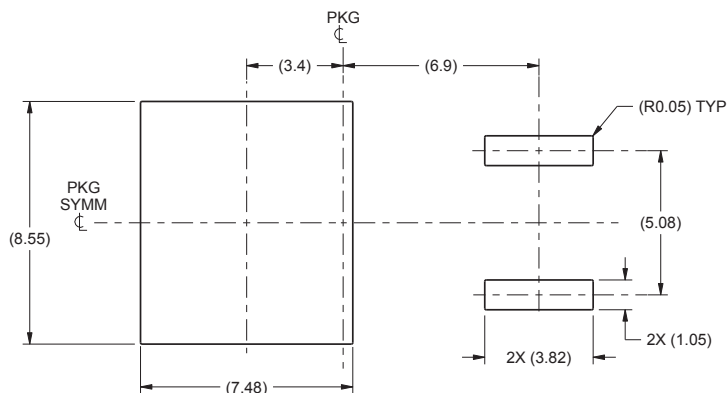

要获得与印刷电路板 (PCB) 设计相关的建议电路布局布线, 请参见《应用说明》文献编号: [SLPA005](#) - 通过 PCB 布局布线技巧来减少振铃。

7.3 建议模板开口 (模板厚度为 0.125mm)

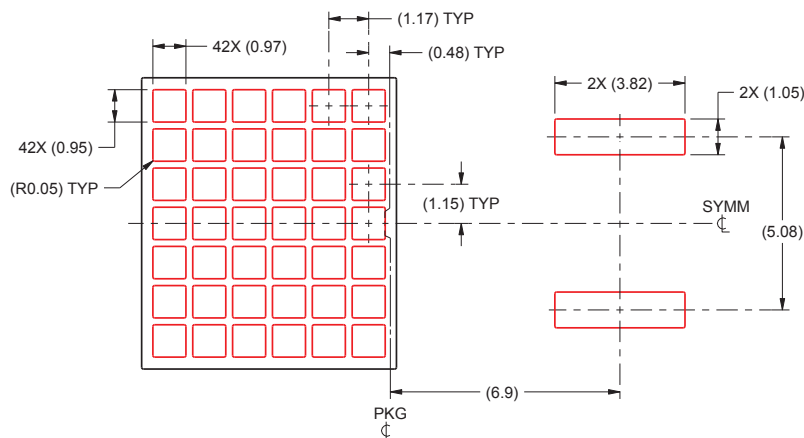

注:

1. 此封装设计用于焊接到电路板的散热焊盘上。更多信息, 请参见应用手册, 《PowerPAD 耐热增强型封装》(文献编号: [SLMA002](#)) 和 《PowerPAD 速成》(文献编号: [SLMA004](#))。
2. 具有漏斗形壁和圆角的激光切割窗孔将提供更佳的焊锡膏脱离。IPC-7525 可能提供其他替代性设计建议。
3. 在电路板装配现场, 对于模板设计可能有不同的建议。

PACKAGING INFORMATION

Orderable part number	Status (1)	Material type (2)	Package Pins	Package qty Carrier	RoHS (3)	Lead finish/ Ball material (4)	MSL rating/ Peak reflow (5)	Op temp (°C)	Part marking (6)
CSD19532KTT	Active	Production	DDPAK/ TO-263 (KTT) 2	500 LARGE T&R	ROHS Exempt	SN	Level-2-260C-1 YEAR	-55 to 175	CSD19532KTT
CSD19532KTT.B	Active	Production	DDPAK/ TO-263 (KTT) 2	500 LARGE T&R	ROHS Exempt	SN	Level-2-260C-1 YEAR	-55 to 175	CSD19532KTT
CSD19532KTTT	Active	Production	DDPAK/ TO-263 (KTT) 2	50 SMALL T&R	ROHS Exempt	SN	Level-2-260C-1 YEAR	-55 to 175	CSD19532KTT
CSD19532KTTT.B	Active	Production	DDPAK/ TO-263 (KTT) 2	50 SMALL T&R	ROHS Exempt	SN	Level-2-260C-1 YEAR	-55 to 175	CSD19532KTT

(1) **Status:** For more details on status, see our [product life cycle](#).

(2) **Material type:** When designated, preproduction parts are prototypes/experimental devices, and are not yet approved or released for full production. Testing and final process, including without limitation quality assurance, reliability performance testing, and/or process qualification, may not yet be complete, and this item is subject to further changes or possible discontinuation. If available for ordering, purchases will be subject to an additional waiver at checkout, and are intended for early internal evaluation purposes only. These items are sold without warranties of any kind.

(3) **RoHS values:** Yes, No, RoHS Exempt. See the [TI RoHS Statement](#) for additional information and value definition.

(4) **Lead finish/Ball material:** Parts may have multiple material finish options. Finish options are separated by a vertical ruled line. Lead finish/Ball material values may wrap to two lines if the finish value exceeds the maximum column width.

(5) **MSL rating/Peak reflow:** The moisture sensitivity level ratings and peak solder (reflow) temperatures. In the event that a part has multiple moisture sensitivity ratings, only the lowest level per JEDEC standards is shown. Refer to the shipping label for the actual reflow temperature that will be used to mount the part to the printed circuit board.

(6) **Part marking:** There may be an additional marking, which relates to the logo, the lot trace code information, or the environmental category of the part.

Multiple part markings will be inside parentheses. Only one part marking contained in parentheses and separated by a "-" will appear on a part. If a line is indented then it is a continuation of the previous line and the two combined represent the entire part marking for that device.

Important Information and Disclaimer: The information provided on this page represents TI's knowledge and belief as of the date that it is provided. TI bases its knowledge and belief on information provided by third parties, and makes no representation or warranty as to the accuracy of such information. Efforts are underway to better integrate information from third parties. TI has taken and continues to take reasonable steps to provide representative and accurate information but may not have conducted destructive testing or chemical analysis on incoming materials and chemicals. TI and TI suppliers consider certain information to be proprietary, and thus CAS numbers and other limited information may not be available for release.

In no event shall TI's liability arising out of such information exceed the total purchase price of the TI part(s) at issue in this document sold by TI to Customer on an annual basis.

重要通知和免责声明

TI“按原样”提供技术和可靠性数据（包括数据表）、设计资源（包括参考设计）、应用或其他设计建议、网络工具、安全信息和其他资源，不保证没有瑕疵且不做任何明示或暗示的担保，包括但不限于对适销性、某特定用途方面的适用性或不侵犯任何第三方知识产权的暗示担保。

这些资源可供使用 TI 产品进行设计的熟练开发人员使用。您将自行承担以下全部责任：(1) 针对您的应用选择合适的 TI 产品，(2) 设计、验证并测试您的应用，(3) 确保您的应用满足相应标准以及任何其他功能安全、信息安全、监管或其他要求。

这些资源如有变更，恕不另行通知。TI 授权您仅可将这些资源用于研发本资源所述的 TI 产品的相关应用。严禁以其他方式对这些资源进行复制或展示。您无权使用任何其他 TI 知识产权或任何第三方知识产权。您应全额赔偿因在这些资源的使用中对 TI 及其代表造成的任何索赔、损害、成本、损失和债务，TI 对此概不负责。

TI 提供的产品受 [TI 的销售条款](#) 或 [ti.com](#) 上其他适用条款/TI 产品随附的其他适用条款的约束。TI 提供这些资源并不会扩展或以其他方式更改 TI 针对 TI 产品发布的适用的担保或担保免责声明。

TI 反对并拒绝您可能提出的任何其他或不同的条款。

邮寄地址：Texas Instruments, Post Office Box 655303, Dallas, Texas 75265
版权所有 © 2025，德州仪器 (TI) 公司