

BZX84Cx 采用 SOT-23 封装的齐纳稳压器二极管

1 特性

- 总功率耗散：430mW (最大值)
- 容差：±5%
- 温度范围：-55°C 至 +150°C
- 引线式封装，用于自动光学检测 (AOI)

2 应用

- 电压调节
- 过压保护

3 说明

BZX84Cx 是一系列采用 SOT-23 封装的稳压二极管。这些二极管可在 5.6V 至 39V 的齐纳电压下使用。

封装信息

器件型号	封装 ⁽¹⁾	封装尺寸 ⁽²⁾
BZX84Cx	DBZ (SOT-23, 3)	2.92mm × 2.37mm

(1) 有关更多信息，请参阅节 8。

(2) 封装尺寸 (长 × 宽) 为标称值，并包括引脚 (如适用)。

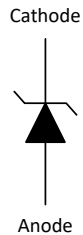

功能方框图



内容

1 特性	1	6 器件和文档支持	7
2 应用	1	6.1 文档支持.....	7
3 说明	1	6.2 接收文档更新通知.....	7
4 引脚配置和功能	3	6.3 支持资源.....	7
5 规格	4	6.4 商标.....	7
5.1 绝对最大额定值.....	4	6.5 静电放电警告.....	7
5.2 建议运行条件.....	4	6.6 术语表.....	7
5.3 热性能信息.....	4	7 修订历史记录	7
5.4 电气特性.....	5	8 机械、封装和可订购信息	8
5.5 典型特性.....	6		

4 引脚配置和功能



图 4-1. DBZ 封装，3 引脚 SOT-23 (顶视图)

表 4-1. 引脚功能

引脚 编号	说明
1	正极
2	无连接
3	负极

5 规格

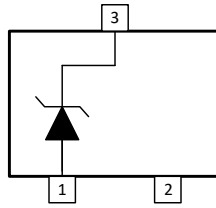
5.1 绝对最大额定值

在自然通风条件下的工作温度范围内测得 (除非另有说明) ⁽¹⁾

		最小值	最大值	单位
P_D ^{(2) (3)}	总功率耗散		430	mW
T_A	环境运行温度	-55	150	°C
T_{stg}	存储温度	-65	155	°C

(1) 超出绝对最大额定值运行可能会对器件造成永久损坏。绝对最大额定值并不表示器件在这些条件下或在建议运行条件以外的任何其他条件下能够正常运行。如果在建议运行条件之外但在绝对最大额定值范围内短暂运行, 器件可能不会受到损坏, 但可能无法完全正常工作。以这种方式运行器件可能会影响器件的可靠性、功能和性能, 并缩短器件寿命。

(2) FR-4 印刷电路板, 单面铜, 标准封装

(3) 在 25°C 时测得

5.2 建议运行条件

在自然通风条件下的工作温度范围内测得 (除非另有说明)

		最小值	标称值	最大值	单位
V_F	正向电压 $I_F = 10\text{mA}$			0.9	V
T_A	自然通风条件下的工作温度	-55		150	°C

5.3 热性能信息

热指标 ⁽¹⁾		BZX84Cx	单位
		DBZ (SOT-23)	
		3 引脚	
$R_{\theta JA}$	结至环境热阻	285.5	°C/W
$R_{\theta JC(top)}$	结至外壳 (顶部) 热阻	197.5	°C/W
$R_{\theta JB}$	结至电路板热阻	118.5	°C/W
Ψ_{JT}	结至顶部特征参数	90.6	°C/W
Ψ_{JB}	结至电路板特征参数	117.8	°C/W
$R_{\theta JC(bot)}$	结至外壳 (底部) 热阻	不适用	°C/W

(1) 有关新旧热指标的更多信息, 请参阅 [半导体和 IC 封装热指标](#) 应用手册。

5.4 电气特性

测试条件为 $T_A = 25^\circ\text{C}$ (除非另有说明)。

器件型号	齐纳电压 I_Z 处的 V_Z (V)				齐纳阻抗 Z_{ZT} (Ω)		反向漏电流 I_R (μA)		温度系数 I_Z 处的 S_Z (mV/C)		电容 C_D (pF) ⁽¹⁾
	最小值	典型值	最大值	I_Z (mA)	最大值	I_Z (mA)	最大值	V_R (V)	最大值	I_Z (mA)	最大值
BZX84C5V6	5.2	5.6	6	5	40	5	0.75	2	2.5	5	200
BZX84C6V8	6.4	6.8	7.2	5	15	5	0.1	4	4.5	5	120
BZX84C8V2	7.79	8.2	8.61	5	15	5	0.6	5.75	6.2	5	80
BZX84C9V1	8.5	9.1	9.6	5	15	5	0.2	6	8	5	90
BZX84C15V	14.25	15	15.75	5	30	5	0.03	10.5	13	5	50
BZX84C16V	15.3	16	17.1	5	40	5	0.03	11.2	15.5	5	50
BZX84C18V	16.8	18	19.1	5	45	5	0.03	12.6	19	5	45
BZX84C27V	25.65	27	28.35	2	80	2	0.03	18.9	25.3	2	35
BZX84C33V	31	33	35	2	90	2	0.03	23.1	37.5	2	30
BZX84C39V	37.05	39	40.95	2	130	2	0.03	27.3	41.2	2	25

(1) $f = 1\text{MHz}$, $V_R = 0$

5.5 典型特性

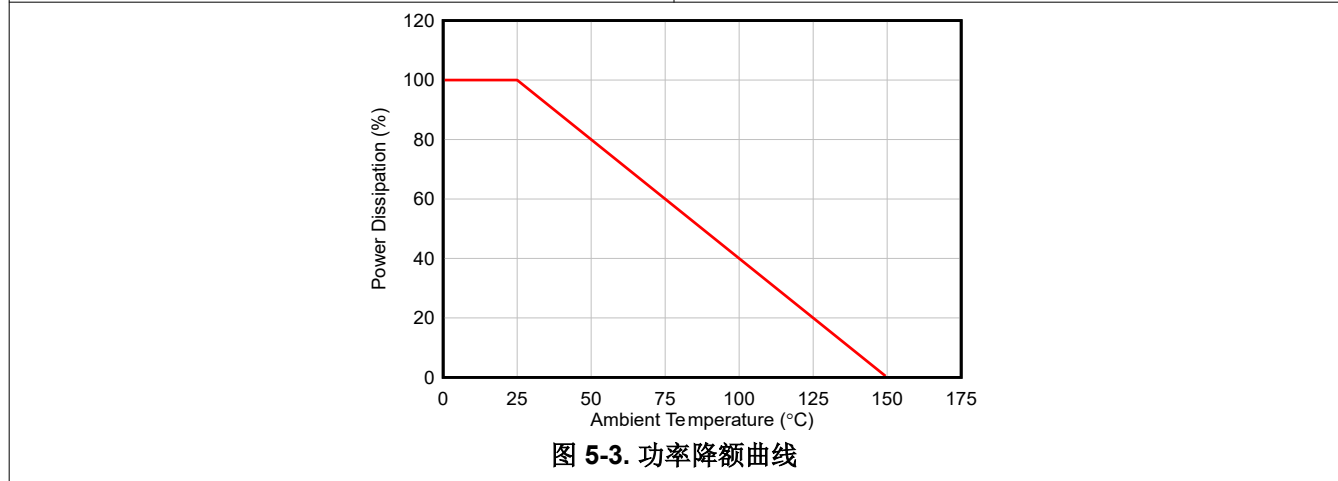
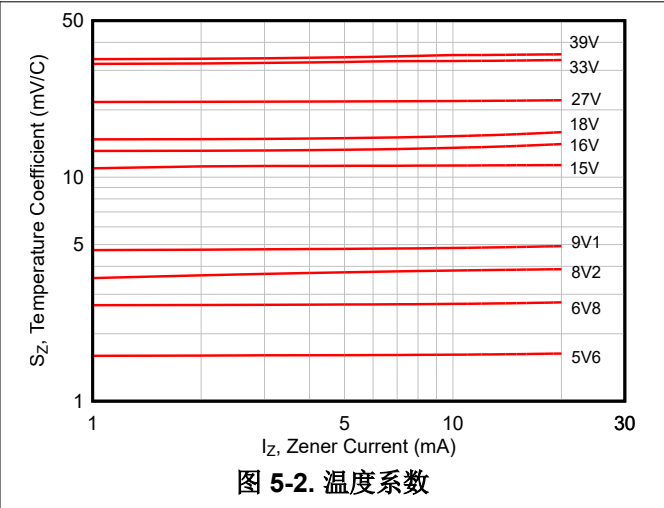
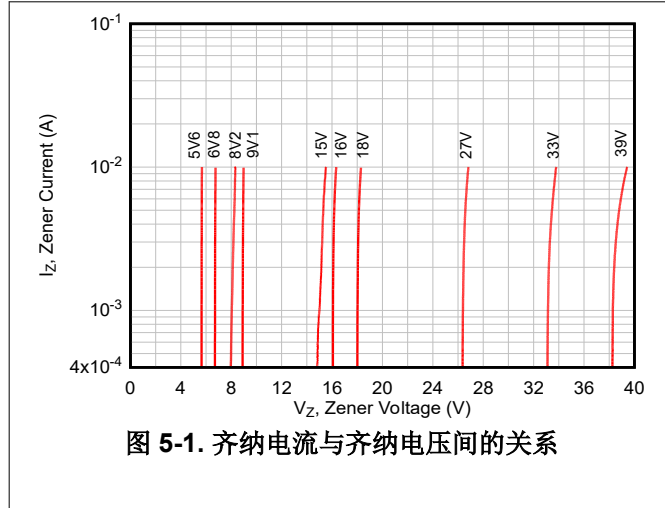

6 器件和文档支持

6.1 文档支持

6.1.1 相关文档

如要查看相关文件，请参阅以下内容：

- 德州仪器 (TI), [二级管封装和布局指南](#)
- 德州仪器 (TI), [二级管布局指南用户指南](#)
- 德州仪器 (TI), [通用评估模块用户指南](#)
- 德州仪器 (TI), [为何在大功率应用中使用 TI 齐纳二极管](#)
- 德州仪器 (TI), [低噪声齐纳二极管](#)

6.2 接收文档更新通知

要接收文档更新通知，请导航至 [ti.com](https://www.ti.com) 上的器件产品文件夹。点击 [通知](#) 进行注册，即可每周接收产品信息更改摘要。有关更改的详细信息，请查看任何已修订文档中包含的修订历史记录。

6.3 支持资源

[TI E2E™ 中文支持论坛](#) 是工程师的重要参考资料，可直接从专家处获得快速、经过验证的解答和设计帮助。搜索现有解答或提出自己的问题，获得所需的快速设计帮助。

链接的内容由各个贡献者“按原样”提供。这些内容并不构成 TI 技术规范，并且不一定反映 TI 的观点；请参阅 TI 的 [使用条款](#)。

6.4 商标

TI E2E™ is a trademark of Texas Instruments.

所有商标均为其各自所有者的财产。

6.5 静电放电警告



静电放电 (ESD) 会损坏这个集成电路。德州仪器 (TI) 建议通过适当的预防措施处理所有集成电路。如果不遵守正确的处理和安装程序，可能会损坏集成电路。

ESD 的损坏小至导致微小的性能降级，大至整个器件故障。精密的集成电路可能更容易受到损坏，这是因为非常细微的参数更改都可能会导致器件与其发布的规格不相符。

6.6 术语表

[TI 术语表](#) 本术语表列出并解释了术语、首字母缩略词和定义。

7 修订历史记录

注：以前版本的页码可能与当前版本的页码不同

Changes from Revision A (August 2025) to Revision B (December 2025)	Page
• 将器件状态从“预告信息”更改为“量产数据”	1
• 新增了 BZX84C5V6、BZX84C6V8、BZX84C9V1、BZX84C16V、BZX84C18V 和 BZX84C33V 器件.....	1

Changes from Revision * (December 2024) to Revision A (August 2025)	Page
• 将功率耗散从 250mW 更新为了 430mW (最大值)	1
• 更新了 电气特性 以包含 15V 和 39V 器件.....	5

8 机械、封装和可订购信息

以下页面包含机械、封装和可订购信息。这些信息是指定器件可用的最新数据。数据如有变更，恕不另行通知，且不会对此文档进行修订。有关此数据表的浏览器版本，请查阅左侧的导航栏。

PACKAGING INFORMATION

Orderable part number	Status (1)	Material type (2)	Package Pins	Package qty Carrier	RoHS (3)	Lead finish/ Ball material (4)	MSL rating/ Peak reflow (5)	Op temp (°C)	Part marking (6)
BZX84C15VDBZR	Active	Production	SOT-23 (DBZ) 3	3000 LARGE T&R	Yes	SN	Level-1-260C-UNLIM	-55 to 150	3O9G
BZX84C15VDBZR.B	Active	Production	SOT-23 (DBZ) 3	3000 LARGE T&R	Yes	SN	Level-1-260C-UNLIM	-55 to 150	3O9G
BZX84C16VDBZR	Active	Production	SOT-23 (DBZ) 3	3000 LARGE T&R	Yes	SN	Level-1-260C-UNLIM	-55 to 150	3WAG
BZX84C18VDBZR	Active	Production	SOT-23 (DBZ) 3	3000 LARGE T&R	Yes	SN	Level-1-260C-UNLIM	-55 to 150	3WDG
BZX84C27VDBZR	Active	Production	SOT-23 (DBZ) 3	3000 LARGE T&R	Yes	SN	Level-1-260C-UNLIM	-55 to 150	3MXG
BZX84C27VDBZR.B	Active	Production	SOT-23 (DBZ) 3	3000 LARGE T&R	Yes	SN	Level-1-260C-UNLIM	-55 to 150	3MXG
BZX84C33VDBZR	Active	Production	SOT-23 (DBZ) 3	3000 LARGE T&R	Yes	SN	Level-1-260C-UNLIM	-55 to 150	3WLG
BZX84C39VDBZR	Active	Production	SOT-23 (DBZ) 3	3000 LARGE T&R	Yes	SN	Level-1-260C-UNLIM	-55 to 150	3IVG
BZX84C39VDBZR.B	Active	Production	SOT-23 (DBZ) 3	3000 LARGE T&R	Yes	SN	Level-1-260C-UNLIM	-55 to 150	3IVG
BZX84C5V6DBZR	Active	Production	SOT-23 (DBZ) 3	3000 LARGE T&R	Yes	SN	Level-1-260C-UNLIM	-55 to 150	3WIG
BZX84C6V8DBZR	Active	Production	SOT-23 (DBZ) 3	3000 LARGE T&R	Yes	SN	Level-1-260C-UNLIM	-55 to 150	3WFG
BZX84C8V2DBZR	Active	Production	SOT-23 (DBZ) 3	3000 LARGE T&R	Yes	SN	Level-1-260C-UNLIM	-55 to 150	3ITG
BZX84C8V2DBZR.B	Active	Production	SOT-23 (DBZ) 3	3000 LARGE T&R	Yes	SN	Level-1-260C-UNLIM	-55 to 150	3ITG
BZX84C9V1DBZR	Active	Production	SOT-23 (DBZ) 3	3000 LARGE T&R	Yes	SN	Level-1-260C-UNLIM	-55 to 150	3WHG

(1) **Status:** For more details on status, see our [product life cycle](#).

(2) **Material type:** When designated, preproduction parts are prototypes/experimental devices, and are not yet approved or released for full production. Testing and final process, including without limitation quality assurance, reliability performance testing, and/or process qualification, may not yet be complete, and this item is subject to further changes or possible discontinuation. If available for ordering, purchases will be subject to an additional waiver at checkout, and are intended for early internal evaluation purposes only. These items are sold without warranties of any kind.

(3) **RoHS values:** Yes, No, RoHS Exempt. See the [TI RoHS Statement](#) for additional information and value definition.

(4) **Lead finish/Ball material:** Parts may have multiple material finish options. Finish options are separated by a vertical ruled line. Lead finish/Ball material values may wrap to two lines if the finish value exceeds the maximum column width.

(5) **MSL rating/Peak reflow:** The moisture sensitivity level ratings and peak solder (reflow) temperatures. In the event that a part has multiple moisture sensitivity ratings, only the lowest level per JEDEC standards is shown. Refer to the shipping label for the actual reflow temperature that will be used to mount the part to the printed circuit board.

(6) **Part marking:** There may be an additional marking, which relates to the logo, the lot trace code information, or the environmental category of the part.

Multiple part markings will be inside parentheses. Only one part marking contained in parentheses and separated by a "~" will appear on a part. If a line is indented then it is a continuation of the previous line and the two combined represent the entire part marking for that device.

Important Information and Disclaimer: The information provided on this page represents TI's knowledge and belief as of the date that it is provided. TI bases its knowledge and belief on information provided by third parties, and makes no representation or warranty as to the accuracy of such information. Efforts are underway to better integrate information from third parties. TI has taken and continues to take reasonable steps to provide representative and accurate information but may not have conducted destructive testing or chemical analysis on incoming materials and chemicals. TI and TI suppliers consider certain information to be proprietary, and thus CAS numbers and other limited information may not be available for release.

In no event shall TI's liability arising out of such information exceed the total purchase price of the TI part(s) at issue in this document sold by TI to Customer on an annual basis.

OTHER QUALIFIED VERSIONS OF BZX84C15V, BZX84C16V, BZX84C18V, BZX84C27V, BZX84C39V, BZX84C5V6, BZX84C6V8, BZX84C8V2, BZX84C9V1 :

● Automotive : [BZX84C15V-Q1](#), [BZX84C16V-Q1](#), [BZX84C18V-Q1](#), [BZX84C27V-Q1](#), [BZX84C39V-Q1](#), [BZX84C5V6-Q1](#), [BZX84C6V8-Q1](#), [BZX84C8V2-Q1](#), [BZX84C9V1-Q1](#)

NOTE: Qualified Version Definitions:

- Automotive - Q100 devices qualified for high-reliability automotive applications targeting zero defects

TAPE AND REEL INFORMATION

QUADRANT ASSIGNMENTS FOR PIN 1 ORIENTATION IN TAPE

*All dimensions are nominal

Device	Package Type	Package Drawing	Pins	SPQ	Reel Diameter (mm)	Reel Width W1 (mm)	A0 (mm)	B0 (mm)	K0 (mm)	P1 (mm)	W (mm)	Pin1 Quadrant
BZX84C15VDBZR	SOT-23	DBZ	3	3000	180.0	8.4	3.2	2.85	1.3	4.0	8.0	Q3
BZX84C16VDBZR	SOT-23	DBZ	3	3000	180.0	8.4	3.2	2.85	1.3	4.0	8.0	Q3
BZX84C18VDBZR	SOT-23	DBZ	3	3000	180.0	8.4	3.2	2.85	1.3	4.0	8.0	Q3
BZX84C27VDBZR	SOT-23	DBZ	3	3000	180.0	8.4	3.2	2.85	1.3	4.0	8.0	Q3
BZX84C33VDBZR	SOT-23	DBZ	3	3000	180.0	8.4	3.2	2.85	1.3	4.0	8.0	Q3
BZX84C39VDBZR	SOT-23	DBZ	3	3000	180.0	8.4	3.2	2.85	1.3	4.0	8.0	Q3
BZX84C5V6DBZR	SOT-23	DBZ	3	3000	180.0	8.4	3.2	2.85	1.3	4.0	8.0	Q3
BZX84C6V8DBZR	SOT-23	DBZ	3	3000	180.0	8.4	3.2	2.85	1.3	4.0	8.0	Q3
BZX84C8V2DBZR	SOT-23	DBZ	3	3000	180.0	8.4	3.2	2.85	1.3	4.0	8.0	Q3
BZX84C9V1DBZR	SOT-23	DBZ	3	3000	180.0	8.4	3.2	2.85	1.3	4.0	8.0	Q3

TAPE AND REEL BOX DIMENSIONS

*All dimensions are nominal

Device	Package Type	Package Drawing	Pins	SPQ	Length (mm)	Width (mm)	Height (mm)
BZX84C15VDBZR	SOT-23	DBZ	3	3000	210.0	185.0	35.0
BZX84C16VDBZR	SOT-23	DBZ	3	3000	210.0	185.0	35.0
BZX84C18VDBZR	SOT-23	DBZ	3	3000	210.0	185.0	35.0
BZX84C27VDBZR	SOT-23	DBZ	3	3000	210.0	185.0	35.0
BZX84C33VDBZR	SOT-23	DBZ	3	3000	210.0	185.0	35.0
BZX84C39VDBZR	SOT-23	DBZ	3	3000	210.0	185.0	35.0
BZX84C5V6DBZR	SOT-23	DBZ	3	3000	210.0	185.0	35.0
BZX84C6V8DBZR	SOT-23	DBZ	3	3000	210.0	185.0	35.0
BZX84C8V2DBZR	SOT-23	DBZ	3	3000	210.0	185.0	35.0
BZX84C9V1DBZR	SOT-23	DBZ	3	3000	210.0	185.0	35.0

DBZ0003A



PACKAGE OUTLINE

SOT-23 - 1.12 mm max height

SMALL OUTLINE TRANSISTOR

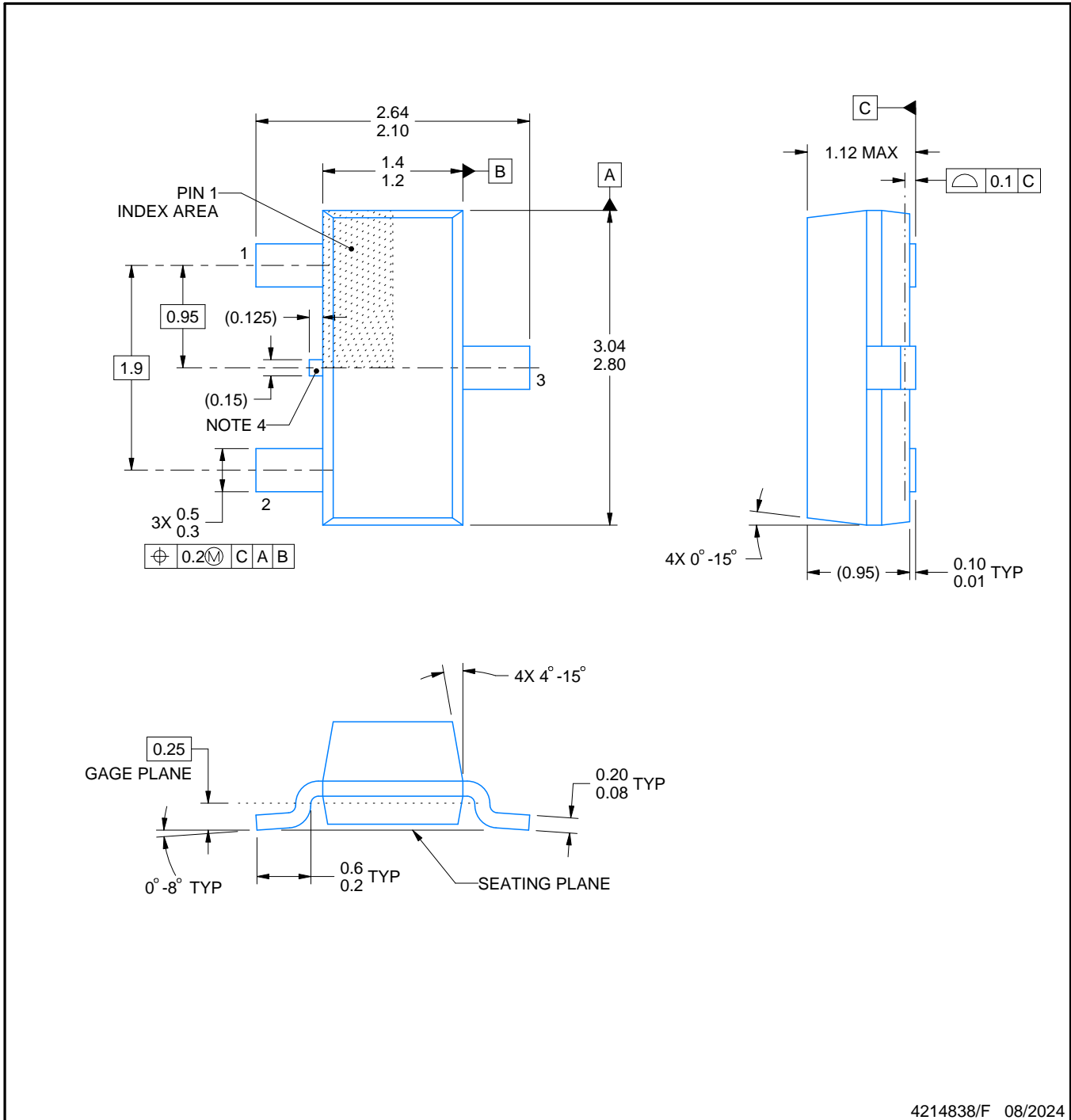

4214838/F 08/2024

NOTES:

1. All linear dimensions are in millimeters. Any dimensions in parenthesis are for reference only. Dimensioning and tolerancing per ASME Y14.5M.
2. This drawing is subject to change without notice.
3. Reference JEDEC registration TO-236, except minimum foot length.
4. Support pin may differ or may not be present.
5. Body dimensions do not include mold flash, protrusions, or gate burrs. Mold flash, protrusions, or gate burrs shall not exceed 0.25mm per side

EXAMPLE BOARD LAYOUT

DBZ0003A

SOT-23 - 1.12 mm max height

SMALL OUTLINE TRANSISTOR



LAND PATTERN EXAMPLE
SCALE:15X



SOLDER MASK DETAILS

4214838/F 08/2024

NOTES: (continued)

- 5. Publication IPC-7351 may have alternate designs.
- 6. Solder mask tolerances between and around signal pads can vary based on board fabrication site.

EXAMPLE STENCIL DESIGN

DBZ0003A

SOT-23 - 1.12 mm max height

SMALL OUTLINE TRANSISTOR

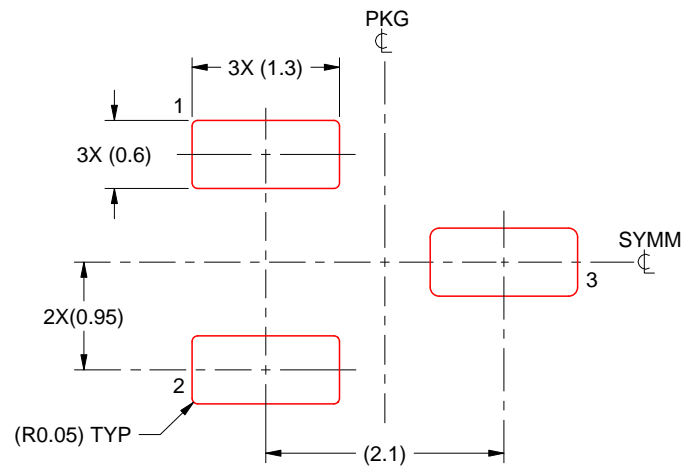

SOLDER PASTE EXAMPLE
BASED ON 0.125 THICK STENCIL
SCALE:15X

4214838/F 08/2024

NOTES: (continued)

7. Laser cutting apertures with trapezoidal walls and rounded corners may offer better paste release. IPC-7525 may have alternate design recommendations.
8. Board assembly site may have different recommendations for stencil design.

重要通知和免责声明

TI“按原样”提供技术和可靠性数据（包括数据表）、设计资源（包括参考设计）、应用或其他设计建议、网络工具、安全信息和其他资源，不保证没有瑕疵且不做任何明示或暗示的担保，包括但不限于对适销性、与某特定用途的适用性或不侵犯任何第三方知识产权的暗示担保。

这些资源可供使用 TI 产品进行设计的熟练开发人员使用。您将自行承担以下全部责任：(1) 针对您的应用选择合适的 TI 产品，(2) 设计、验证并测试您的应用，(3) 确保您的应用满足相应标准以及任何其他安全、安保法规或其他要求。

这些资源如有变更，恕不另行通知。TI 授权您仅可将这些资源用于研发本资源所述的 TI 产品的相关应用。严禁以其他方式对这些资源进行复制或展示。您无权使用任何其他 TI 知识产权或任何第三方知识产权。对于因您对这些资源的使用而对 TI 及其代表造成的任何索赔、损害、成本、损失和债务，您将全额赔偿，TI 对此概不负责。

TI 提供的产品受 [TI 销售条款](#)、[TI 通用质量指南](#) 或 [ti.com](#) 上其他适用条款或 TI 产品随附的其他适用条款的约束。TI 提供这些资源并不会扩展或以其他方式更改 TI 针对 TI 产品发布的适用的担保或担保免责声明。除非德州仪器 (TI) 明确将某产品指定为定制产品或客户特定产品，否则其产品均为按确定价格收入目录的标准通用器件。

TI 反对并拒绝您可能提出的任何其他或不同的条款。

版权所有 © 2026，德州仪器 (TI) 公司

最后更新日期：2025 年 10 月